

Historic, archived document

Do not assume content reflects current scientific knowledge, policies, or practices.

YEARBOOK

OF THE

UNITED STATES
DEPARTMENT OF
AGRICULTURE

1918



WASHINGTON
GOVERNMENT PRINTING OFFICE
1919

[CHAPTER 23, STAT. L., 1895.]

* * * * *

[AN ACT Providing for the public printing and binding and the distribution of public documents.]

* * * * *

Section 73, paragraph 2:

The Annual Report of the Secretary of Agriculture shall hereafter be submitted and printed in two parts, as follows: Part One, which shall contain purely business and executive matter which it is necessary for the Secretary to submit to the President and Congress; Part Two, which shall contain such reports from the different Bureaus and Divisions, and such papers prepared by their special agents, accompanied by suitable illustrations, as shall, in the opinion of the Secretary, be specially suited to interest and instruct the farmers of the country, and to include a general report of the operations of the Department for their information. There shall be printed of Part One, one thousand copies for the Senate, two thousand copies for the House, and three thousand copies for the Department of Agriculture; and of Part Two, one hundred and ten thousand copies for the use of the Senate, three hundred and sixty thousand copies for the use of the House of Representatives, and thirty thousand copies for the use of the Department of Agriculture, the illustrations for the same to be executed under the supervision of the Public Printer, in accordance with directions of the Joint Committee on Printing, said illustrations to be subject to the approval of the Secretary of Agriculture; and the title of each of the said parts shall be such as to show that such part is complete in itself.

ORGANIZATION OF U. S. DEPARTMENT OF AGRICULTURE.

CORRECTED TO JULY 1, 1919.

Secretary of Agriculture, DAVID FRANKLIN HOUSTON.

Assistant Secretary of Agriculture, CLARENCE OUSLEY.

Assistant to the Secretary, FLOYD R. HARRISON.

Assistant to the Secretary, ALONZO E. TAYLOR.

Solicitor, WILLIAM MARTIN WILLIAMS.

Office of Farm Management, HENRY C. TAYLOR, *Chief*.

Chief Clerk, R. M. REESE.

Appointment Clerk, P. L. GLADMON.

Expert on Exhibits, F. LAMSON-SCRIBNER.

Office of Information, HARLAN SMITH, *Chief*.

Weather Bureau, CHARLES F. MARVIN, *Chief*.

Bureau of Animal Industry, JOHN R. MOHLER, *Chief*.

Bureau of Plant Industry, WM. A. TAYLOR, *Plant Physiologist and Pathologist and Chief*.

Forest Service, HENRY S. GRAVES, *Forester and Chief*.

Bureau of Chemistry, CARL L. ALSBERG, *Chemist and Chief*.

Bureau of Soils, MILTON WHITNEY, *Soil Physicist and Chief*.

Bureau of Entomology, L. O. HOWARD, *Entomologist and Chief*.

Bureau of Biological Survey, EDWARD W. NELSON, *Biologist and Chief*.

Division of Accounts and Disbursements, A. ZAPPONE, *Chief and Disbursing Clerk*.

Division of Publications, EDWY B. REID, *Chief*.

Bureau of Crop Estimates, LEON M. ESTABROOK, *Statistician and Chief*.

States Relations Service, A. C. TRUE, *Director*.

Bureau of Public Roads, THOMAS H. MACDONALD, *Chief*.

Bureau of Markets, GEORGE LIVINGSTON, *Acting Chief*.

Librarian, CLARIBEL R. BARNETT.

Insecticide and Fungicide Board, J. K. HAYWOOD, *Chairman*.

Federal Horticultural Board, C. L. MARLATT, *Chairman*.



CONTENTS.

	Page.
Report of Secretary.....	9
The Black Stem Rust and the Barberry. By E. C. Stakman.....	75
Cattle Loans and their Value to Investors. By Charles S. Cole.....	101
Better Poultry Through Community Breeding Associations. By J. W. Kinghorne.....	109
Composition and Food Value of Bottled Soft Drinks. By J.W. Sale and W. W. Skinner.....	115
The Old and the New in Corn Culture. By H. Howard Biggar.....	123
The Drainage Movement in the United States. By S. H. McCrory..	137
Rabbit Growing to Supplement the Meat Supply. By Ned Dear- born.....	145
How Dairying Built Up a Community. By J. C. McDowell.....	153
The Place of Rye in American Agriculture. By Clyde E. Leighty..	169
Home Mixing of Fertilizers. By C. C. Fletcher.....	185
Less Cholera—More Hogs. By O. B. Hess.....	191
Some Effects of the War Upon the Seed Industry of the United States. By W. A. Wheeler and G. C. Edler.....	195
The Accredited-Herd Plan in Tuberculosis Eradication. By J. A. Kiernan.....	215
Electric Light and Power from Small Streams. By A. M. Daniels..	221
Some Results of Federal Quarantine Against Foreign Live-Stock Diseases. By G. W. Pope.....	239
The Thrashing Ring in the Corn Belt. By J. C. Rundles.....	247
The Rediscovery of an Old Dish. By Herbert P. Davis.....	269
Following the Produce Markets. By G. B. Fiske.....	277
Live Stock and Reconstruction. By George M. Rommel.....	289
Federal Protection of Migratory Birds. By George A. Lawyer.....	303
Farm Woodlands and the War. By Henry S. Graves.....	317
How Weevils Get Into Beans. By E. A. Back.....	327
The Farmer and Federal Grain Supervision. By Ralph H. Brown..	335
Housing the Worker on the Farm. By E. B. McCormick.....	347
Sisal and Henequen as Binder-twine Fibers. By H. T. Edwards...	357
The Commercial Apple Industry in the United States. By J. C. Folger.....	367
Government Market Reports on Live Stock and Meats. By James Atkinson.....	379
Cotton Warehousing—Benefits of an Adequate System. By Roy L. Newton and James M. Workman.....	399
Arable Land in the United States. By O. E. Baker and H. M. Strong	433
Appendix:	
Agricultural Colleges in the United States.....	443
Agricultural Experiment Stations.....	445
State Officials in Charge of Agriculture.....	445

	Page.
Appendix—Continued.	
State Officers in Charge of Cooperative Agricultural Extension Work.....	446
Live-Stock Associations.....	448
Statistics of Grain Crops, 1918.....	449
Statistics of Crops Other than Grain Crops.....	507
Live Stock, 1918.....	587
Imports and Exports of Agricultural Products.....	627
Miscellaneous Agricultural Statistics.....	667
Index.....	727

ILLUSTRATIONS.

PLATES.

	Page.
PLATE I. A good stand of wheat, not rusted.....	76
II. Wheat ruined by rust.....	76
III. Black stem rust on grains and grasses.....	80
IV. Life-history of black stem rust.....	80
V. Fig. 1.—A common barberry bush. Fig. 2.—Barberry leaf showing cluster cups.....	88
VI. Fig. 1.—Hedge of Japanese barberry. Fig. 2.—Common barberry bush in hedge of Japanese barberry.....	88
VII. Fig. 1.—The Oregon grape. Fig. 2.—A wild barberry.....	88
VIII. Bluffs on which barberries have escaped and been running wild.....	88
IX. Fig. 1.—Neglected hedge of barberry. Fig. 2.—Common wild grasses which rust heavily.....	96
X. Fig. 1.—Sprouts of common barberry. Fig. 2.—Proper way to remove barberry bushes.....	96
XI. Types of fowls.....	110
XII. Fig. 1.—Community poultry-breeding house and community poultry club. Fig. 2.—Pen of Barred Plymouth Rocks.....	110
XIII. Fig. 1.—Boys' and Girls' Rhode Island Red Community Association. Fig. 2.—Government poultry adviser instructing association members in the use of the market poultry score card.....	112
XIV. Flocks of standard-bred and mongrel hens.....	112
XV. Types of corn raised by the Indians and husking implements.....	124
XVI. Indian corn planters.....	124
XVII. Methods of drying corn and an Indian cornfield.....	128
XVIII. Fig. 1.—Stone mortar and pestle. Fig. 2.—Indians using a wooden mortar and pestle.....	128
XIX. Fig. 1.—The Everglades west of Fort Lauderdale. Fig. 2.—Dredge digging drainage ditch through a swamp.....	138
XX. Permanent swamp and swamp lands that have been reclaimed.....	138
XXI. Periodically overflowed timberland.....	138
XXII. Fig. 1.—Stream valley which could not be cultivated until channel was improved. Fig. 2.—Corn killed by overflow.....	138
XXIII. Potatoes and corn growing on drained land.....	138
XXIV. Winter wheat, cotton, and truck growing on drained swamp lands.....	138
XXV. Checkered and gray giant rabbits.....	148
XXVI. Belgian hare and New Zealand red rabbit.....	148
XXVII. The creamery at Grove City, and butter makers at work.....	156
XXVIII. Fig. 1.—Association herd that stood highest in butter-fat production in 1918. Fig. 2.—Highest milk production in cow-testing association in 1918.....	156
XXIX. Fig. 1.—Sire that helped improve the dairy herds. Fig. 2.—Field man and veterinarians about to go to near-by farms to test cattle for tuberculosis.....	160
XXX. Fig. 1.—Calf that won first prize at Stoneboro fair. Fig. 2.—Modern farm house near Grove City.....	160
XXXI. Fig. 1.—Important precaution in hog-cholera control. Fig. 2.—Practical and inexpensive disinfecting outfit.....	192
XXXII. Fig. 1.—Herd of immune brood sows. Fig. 2.—Pigs from immune sows.....	192
XXXIII. Where appearances are unreliable.....	218
XXXIV. The first officially accredited herd.....	218
XXXV. Zebu bull and dogs in quarantine.....	242
XXXVI. Federal quarantine station and a cattle-carrying ocean liner.....	242
XXXVII. Cottage-cheese club sandwich and cottage-cheese loaf.....	272
XXXVIII. Results of protection of migratory birds.....	306
XXXIX. Fig. 1.—A typical hunting section of the Northwest. Fig. 2.—Lesser scaup duck at Palm Beach, Fla.....	306

	Page.
PLATE XL. A sight that thrills the hunter	306
XLI. Life cycle of a weevil in a bean	330
XLII. Broad and navy beans infested with weevils	330
XLIII. Weevil-infested beans and cowpeas	330
XLIV. Federal grain-grading booth at State fair	340
XLV. Fig. 1.—Securing a sample of grain. Fig. 2.—Test of dockage, sieves and pan	340
XLVI. Tester for determining the moisture content of grain	340
XLVII. Branch inspection offices of the Department of Agriculture	340
XLVIII. Fig. 1.—Self-binder in operation. Fig. 2.—Sisal in Porto Rico	360
XLIX. Hehequen in Cuba and Porto Rico	360
L. Fig. 1.—Manila maguey. Fig. 2.—Retting maguey	364
LI. Sisal in Porto Rico and Florida	364
LII. Commercial and neglected apple orchards	368
LIII-LVI. Maps showing improved land, land not in farms, topography, and precipitation	434
LVII-LXI. Maps showing length of growing season, forest and woodland, forest and cut-over land, swamps and wet lands, and irrigated area	436
LXII. Graph showing use of the land	436

TEXT FIGURES.

FIG. 1. The common barberry and the Japanese barberry, showing the differences.....	90
2. A convenient rabbit hutch.....	151
3. Diagram indicating what fertilizer materials may and may not be safely mixed..	187
4. Counties in which tomato, pepper, carrot, celery, and salsify were grown commercially for seed in 1918.....	200
5. Counties in which cucumber, melons, squash, and pumpkin were grown commercially for seed in 1918.....	201
6. Counties in which sweet corn, cabbage, spinach, kale, parsley, and lettuce were grown commercially for seed in 1918.....	202
7. Counties in which onion seed and sets, radish, turnip, and parsnip were grown commercially for seed in 1918.....	203
8. Counties in which garden peas and beans (not including lima beans) were grown commercially for seed in 1918.....	204
9. Counties in which sugar beet, garden beet, and mangel were grown commercially for seed in 1918.....	205
10. Cross-section method of measuring a stream flow.....	229
11. The weir method of stream measurement.....	230
12. A method for finding the distance water will back up from a dam.....	234
13. Extent of leased-wire system and location of the 32 branches at market centers during the 1918-19 shipping season	281
14. Location of the 91 temporary farmers' service offices at shipping points during the 1918-19 shipping season	236
15. Open seasons for waterfowl migrating between United States and Canada.....	312
16. Open seasons for plovers and yellow-legs.....	312
17. Cottage for man and wife with one or two small children.....	349
18. A larger cottage with one more room than that shown in figure 17.....	350
19. A simple comfortable bunk house for three to six men	351
20. A larger bunk house with kitchen and dining room.....	352
21. Cottage plot containing garden, etc.....	353
22. View of cottage and grounds.....	354
23-24. Plans for cottages and grounds.....	355, 356
25. Areas of commercial apple production in the United States	370
26. Fluctuations of New York spot-price levels for Middling Upland cotton.....	402-403
27. Timbers supported by pilasters, eorrels, or offsets and self-releasing.....	410
28. An economical method of framing posts and timbers	411
29. Division fire wall arranged as an economical fire stop	412
30. Method of forming fire stop by division fire wall without obstruction to platforms.....	413
31. Plan and elevation for a convenient office and classing room	418
32. Other drawings of the plan shown in figure 31	419
33-34. Form of warehouse receipt.....	430, 431

YEARBOOK OF THE U.S. DEPARTMENT OF AGRICULTURE

REPORT OF THE SECRETARY OF AGRICULTURE.

WASHINGTON, D. C., November 15, 1918.

SIR: The part the millions of men, women, boys, and girls on the farms, and the organized agricultural agencies assisting them, including the Federal Department of Agriculture, the State colleges and departments of agriculture, and farmers' organizations, played during the war in sustaining this Nation and those with which we are associated is striking but altogether too little known and appreciated. On them rested the responsibility for maintaining and increasing food production and for assisting in securing fuller conservation of food and feed stuffs. The satisfactory execution of their task was of supreme importance and difficulty.

The proper utilization of available foods is one thing; the increase of production along economic lines is quite a different thing. It is prerequisite and fundamental. It is one thing to ask a man to save; it is another to ask him, confronted as he is by the chances of the market and the risk of loss from disease, flood, and drouth, to put his labor and capital into the production of food, feeds, and the raw material for clothing.

The work of the agricultural agencies is not much in the public eye. There is little of the dramatic about it. The millions of people in the rural districts are directly affected by it and are in more or less intimate touch with it, but to the great urban population it is comparatively unknown. Usually people in cities devote very little thought to the rural districts; and many of them fortunately, in normal times, have to concern themselves little about the food sup-

ply and its sources. The daily press occupies itself largely with the news of the hour, and the magazines have their attention centered chiefly on other activities. Consequently, the people in large centers have slight opportunity to acquaint themselves with rural problems and agencies. Although the Nation has, in its Federal Department and the State colleges and departments, agricultural agencies for the improvement of farming which, in point of personnel, financial support, and effectiveness, excel those of any other three nations combined, very many urban people were unaware of the existence of such institutions, and not a few representations were made to the effect that an administration ought to be created to secure an increase of production. These people have seen the windows of cities placarded and papers filled with pleas for conservation, for investment in bonds, and for subscriptions to the Red Cross. They have wondered why they have not seen similar evidence of activity in the field of agriculture. They did not know of the thousands of men and women quietly working in every rural community of the Nation and of the millions of bulletins and circulars dealing with the problems from many angles. They overlooked the fact that the field of these workers lies outside of the city and did not recognize that both the problem and the methods were different.

Within the last year there has been a change. The attention of the world has been directed to its food supply, and agriculture has assumed a place of even greater importance in the world's thought. More space has been devoted to it by the daily press and weekly journals and magazines. This is gratifying. The towns and cities, all of them directly dependent upon agriculture for their existence and most of them for their growth and prosperity, must of necessity take an intelligent, constructive interest in rural problems and in the betterment of rural life. This they can do effectively only as they inform themselves and lend their support to

the carefully conceived plans of Federal and State organizations responsible for leadership and of the more thoughtful and successful farmers. For some time it has been part of the plans of this Department to enlist the more complete cooperation of bankers and other business men and of their associations in the effort to make agriculture more profitable and rural communities more healthful and attractive. Recent events have lent emphasis to the appeals and very marked responses have been made in every part of the Union.

THE AGRICULTURAL EFFORT.

The efforts put forth by the farmers and the agricultural organizations to secure increased production can perhaps best be concretely indicated in terms of planting operations. The size of the harvest may not be the measure of the labors of the farmers. Adverse weather conditions and unusual ravages of insects or plant diseases may partly overcome and neutralize the most exceptional exertions.

ACREAGE.

The first year of our participation in the war, 1917, witnessed the Nation's record for acreage planted—283,000,000 of the leading cereals, potatoes, tobacco, and cotton, as against 261,000,000 for the preceding year, 251,000,000 for the year prior to the outbreak of the European war, and 248,000,000 for the five-year average, 1910–1914. This is a gain of 22,000,000 over the year preceding our entry into the war and of 35,000,000 over the five-year average indicated. Even this record was exceeded the second year of the war. There was planted in 1918 for the same crops 289,000,000 acres, an increase over the preceding record year of 5,600,000. It is especially noteworthy that, while the acreage planted in wheat in 1917 was slightly less than that for the record year of 1915, it exceeded the five-year average (1910–1914) by

7,000,000; that the acreage planted in 1918 exceeded the previous record by 3,500,000; and that the indications are that the acreage planted during the current fall season will considerably exceed that of any preceding fall planting.

YIELDS.

In each of the last two years climatic conditions over considerable sections of the Union were adverse—in 1917 especially for wheat and in 1918 for corn. Notwithstanding this fact, the aggregate yield of the leading cereals in each of these years exceeded that of any preceding year in the Nation's history except 1915. The estimated total for 1917 was 5,796,000,000 bushels and for 1918, 5,638,000,000 bushels, a decrease of approximately 160,000,000 bushels. But the conclusion would be unwarranted that the available supplies for human food or the aggregate nutritive value will be less in 1918 than in 1917. Fortunately, the wheat production for the current year—918,920,000 bushels—is greatly in excess of that for each of the preceding two years, 650,828,000 in 1917 and 636,318,000 in 1916, and is next to the record wheat crop of the Nation. The estimated corn crop, 2,749,000,000 bushels, exceeds the five-year prewar average by 17,000,000 bushels, is 3.4 per cent above the average in quality, and greatly superior to that of 1917. It has been estimated that of the large crop of last year, approximately 900,000,000 bushels were soft. This, of course, was valuable as feed for animals, but less so than corn of normal quality. It should be remembered, in thinking in terms of food nutritional value, that, on the average, only about 12 per cent of the corn crop is annually consumed by human beings and that not more than 26 per cent ever leaves the farm. It should be borne in mind also that the stocks of corn on the farms November 1, 1918, were 118,400,000 bushels, as against less than 35,000,000 bushels last year, and 93,340,000 bushels, the

average for the preceding five years. It is noteworthy that the quality of each of the four great cereals—barley, wheat, corn, and oats—ranges from 3 to 5.4 per cent above the average.

Equally striking are the results of efforts to secure an ampler supply of meat and dairy products. In spite of the large exportation of horses and mules, the number remaining on farms is estimated to be 26,400,000, compared with 25,400,000 for the year preceding the European war and 24,700,000, the annual average for 1910–1914. The other principal classes of live stock also show an increase in number—milch cows of 2,600,000, or from 20,700,000 in 1914 to 23,300,000 in 1918; other cattle of 7,600,000, or from 35,900,000 to 43,500,000; and swine of 12,500,000, or from 58,900,000 to 71,400,000. Within the last year, for the first time in many years, there was an increase in the number of sheep—1,300,000, or from 47,616,000 in 1917 to 48,900,000 in 1918.

In terms of product the results are equally striking. The number of pounds of beef for 1918 is given at 8,500,000,000 pounds, as against 6,079,000,000 for 1914; of pork, at 10,500,000,000, as against 8,769,000,000; and of mutton, at 495,000,000, as against 739,000,000, a total of all these products of 19,495,000,000 for the last year and 15,587,000,000 for the year preceding the European war.

An increase is estimated in the number of gallons of milk produced, of 922,000,000, or from 7,507,000,000 to 8,429,000,000, and in the pounds of wool of 9,729,000, or from 290,192,000 to 299,921,000. The figures for poultry production have not been accurately ascertained, but it is roughly estimated that in 1918 we raised 589,000,000 head, compared with 544,000,000 in 1914 and 522,000,000, the five-year average, 1910–1914, while the number of dozens of eggs increased by 147,000,000, or from 1,774,000,000 in 1914 to 1,921,000,000 in 1918, and, in the last year exceeded the five-year average by 226,000,000.

The following tables may facilitate the examination of these essential facts:

Acreage of crops in the United States.

[Figures refer to planted acreage.]

Crop.	1918, subject to revision.	1917, subject to revision.	1916	1914	Annual average, 1910-1914.
CEREALS.					
Corn.....	113, 835, 000	119, 755, 000	105, 296, 000	103, 435, 000	105, 240, 000
Wheat.....	64, 659, 000	59, 045, 000	56, 810, 000	54, 661, 000	52, 452, 000
Oats.....	44, 475, 000	43, 572, 000	41, 527, 000	38, 442, 000	38, 014, 000
Barley.....	9, 108, 000	8, 835, 000	7, 757, 000	7, 565, 000	7, 593, 000
Rye.....	6, 119, 000	4, 480, 000	3, 474, 000	2, 733, 000	2, 562, 000
Buckwheat.....	1, 045, 000	1, 006, 000	828, 000	792, 000	826, 000
Rice.....	1, 120, 400	964, 000	869, 000	694, 000	733, 000
Kafirs.....	5, 114, 000	5, 153, 000	3, 944, 000
Total.....	245, 475, 400	242, 810, 000	220, 505, 000	1208, 322, 000	1207, 420, 000
VEGETABLES.					
Potatoes.....	4, 113, 000	4, 390, 000	3, 565, 000	3, 711, 000	3, 686, 000
Sweet potatoes.....	959, 000	953, 000	774, 000	603, 000	611, 000
Total.....	5, 072, 000	5, 343, 000	4, 339, 000	4, 314, 000	4, 297, 000
Tobacco.....	1, 452, 900	1, 447, 000	1, 413, 000	1, 224, 000	1, 209, 000
Cotton.....	37, 073, 000	33, 841, 000	34, 985, 000	36, 832, 000	35, 330, 000
Grand total.....	289, 073, 300	283, 441, 000	261, 242, 000	1250, 692, 000	1248, 256, 000

¹ Excluding kafirs.

Production in the United States.

[Figures are in round thousands; i. e., 000 omitted.]

Crops.	1918 (unrevised estimate, November, 1918).	1917, subject to revision.	1916	1914	Annual average, 1910-1914.
CEREALS.					
Corn..... bush..	2, 749, 198	3, 159, 494	2, 566, 927	2, 672, 804	2, 732, 457
Wheat..... do....	918, 920	650, 828	636, 318	891, 017	728, 225
Oats..... do....	1, 535, 297	1, 587, 286	1, 251, 837	1, 141, 060	1, 157, 961
Barley..... do....	236, 505	208, 975	182, 309	194, 953	186, 208
Rye..... do....	76, 687	60, 145	48, 862	42, 779	37, 568
Buckwheat..... do....	18, 370	17, 460	11, 662	16, 881	17, 022
Rice..... do....	41, 918	36, 278	40, 861	23, 649	24, 378
Kafirs..... do....	61, 182	75, 866	53, 858
Total..... do....	5, 638, 077	5, 796, 332	4, 792, 634	4, 983, 143	4, 883, 819

Production in the United States—Continued.

Crops.	1918 (unrevised estimate, November, 1918).	1917, subject to revision.	1916	1914	Annual average, 1910-1914.
VEGETABLES.					
Potatoes.....bush..	390, 101	442, 536	286, 953	409, 921	360, 772
Sweet potatoes.....do...	88, 114	87, 141	70, 955	56, 574	57, 117
Beans (commercial).....do...	17, 802	14, 967	10, 715	11, 585
Onions, fall commercial crop.....do...	13, 438	12, 309	7, 833	(¹)
Cabbage (commercial).....tons..	565	475	252	(¹)
FRUITS.					
Peaches.....bush..	40, 185	45, 066	37, 505	54, 109	43, 752
Pears.....do...	10, 342	13, 281	11, 874	12, 086	11, 184
Apples.....do...	197, 360	174, 608	204, 582	253, 200	197, 898
Cranberries, 3 States.....bbls..	374	255	471	644
MISCELLANEOUS.					
Flaxseed.....bush..	14, 646	8, 473	14, 296	13, 749	18, 353
Sugar beets.....tons..	6, 549	5, 980	6, 228	5, 585	5, 391
Tobacco.....lbs..	1, 266, 686	1, 196, 451	1, 153, 278	1, 034, 679	991, 958
All hay.....tons..	86, 254	94, 930	110, 992	88, 686	81, 640
Cotton.....bales..	11, 818	11, 302	11, 450	16, 135	14, 259
Sorghum sirup.....galls..	29, 757	34, 175	13, 668
Peanuts.....bush..	52, 617	56, 104	35, 324
Broom corn, 5 States.....tons..	52	52	39
Clover seed.....bush..	1, 248	1, 439	1, 706

¹ No estimate.

Number of live stock on farms on Jan. 1, 1910-1918.

[Figures are in round thousands; i. e., 000 omitted.]

Kind,	1918	1917	1916	1914	Annual average, 1910-1914.
Horses.....	21, 563	21, 210	21, 159	20, 962	20, 430
Mules.....	4, 824	4, 723	4, 593	4, 449	4, 346
Milch cows.....	23, 284	22, 894	22, 108	20, 737	20, 676
Other cattle.....	43, 546	41, 689	39, 812	35, 855	38, 000
Sheep.....	48, 900	47, 616	48, 625	49, 719	51, 929
Swine.....	71, 374	67, 503	67, 766	58, 933	61, 865

Estimated production of meat, milk, and wool.

[Figures are in round thousands; i. e., 000 omitted.]

Product.	1918	1917	1916	1914	1909
Beef ¹pounds..	8, 500, 000	7, 384, 007	6, 670, 938	6, 078, 908	8, 138, 000
Pork ¹do.....	10, 500, 000	8, 450, 148	10, 587, 765	8, 768, 532	8, 199, 000
Mutton and goat ¹do.....	495, 000	491, 205	633, 969	739, 401	615, 000
Total.....do.....	19, 495, 000	16, 325, 360	17, 892, 672	15, 586, 841	16, 952, 000
Milk ²gallons..	8, 429, 000	8, 288, 000	8, 003, 000	7, 507, 000	7, 466, 406
Wool (including pulled wool) pounds.....	299, 921	281, 892	288, 490	290, 192	289, 420
Eggs produced ²dozens..	1, 921, 000	1, 884, 000	1, 848, 000	1, 774, 000	³ 1, 591, 000
Poultry raised ²number..	589, 000	578, 000	567, 000	544, 000	³ 488, 000

¹ Estimated, for 1914-1917, by the Bureau of Animal Industry. Figures for meat production for 1918 are tentative estimates based upon 1917 production and a comparison of slaughter under Federal inspection for nine months of 1918 with the corresponding nine months in 1917.

² Rough estimate.

³ Annual averages for 1910-1914: Eggs, 1,695,000,000 dozen; poultry, 522,000,000.

VALUES.

On the basis of prices that have recently prevailed, the value of all crops produced in 1918 and of live stock on farms on January 1, including horses, mules, cattle, sheep, swine, and poultry, is estimated to be \$24,700,000,000, compared with \$21,325,000,000 for 1917, \$15,800,000,000 for 1916, \$12,650,000,000 for 1914, and \$11,700,000,000 for the five-year average. Of course, this greatly increased financial showing does not mean that the Nation is better off to that extent or that its real wealth has advanced in that proportion. Considering merely the domestic relations, the true state is indicated rather in terms of real commodities, comparative statements of which are given in foregoing paragraphs. The increased values, however, do reveal that the monetary returns to the farmers have increased proportionately with those of other groups of producers in the Nation and that their purchasing power has kept pace in the rising scale of prices.

PLANS FOR 1919.

It is too early to make detailed suggestions for the spring planting season of 1919. During this fall the Department, the agricultural colleges, and other agencies carried on a campaign for a large wheat acreage, and indications were given by States as to where the requisite planting could be secured without calling for an extension of the area or even a normal acreage in the States which had suffered from drouth for two years. It was suggested that, if possible, at least 45,000,000 acres of wheat should be planted. Fortunately, we have two seasons for wheat sowing, and the Department was aware of the fact that, if a large acreage was planted in the fall and came through the winter in good condition, there would be an opportunity to make appropriate suggestions in reference to the spring operations. The informal indications coming to the Department are that the farmers exceeded the plantings suggested by the Department. We do not know how either the wheat or the rye will come through the winter, and are not now able to state what the requirements should be for the next season, nor can anyone now tell what the world demand will be at the close of the harvest season of 1919. We do know that for the ensuing months the Nation is likely to be called upon for large quantities of available food and feeds to supply not only the peoples with whom we cooperated in the war but also those of the neutrals and the central powers. This will involve a continuation of conservation on the part of our people and probably of the maintenance of a satisfactory range of prices for food products during the period. When the nations of Europe will return to somewhat normal conditions and resume the planting of bread and feed grains sufficient in large measure to meet their requirements, and whether the shipping will open up sufficiently to permit the free movement

of grains from distant countries like Australia, India, and Argentina, it is impossible now to say. It is certain that all these nations will direct their attention very specifically to the producing of supplies in respect to which good returns may naturally be expected. It will be to the interest of the whole world to expedite this process as much as possible; and, while the problem of immediate distribution of available foods demands urgent consideration, the production programs for the next harvest should also receive no less common and urgent attention.

Two things seem to be clear. One is that for a considerable period the world will have need particularly of a larger supply than normal of certain live stock, and especially of fats. We must not fail, therefore, to adopt every feasible means of economically increasing these things; and, as a part of our program, we shall give thought to the securing of an adequate supply of feed stuffs and to the eradication and control of all forms of animal disease. The Department has already taken steps in this direction and has issued a circular containing detailed suggestions.

Another is the need of improving the organization of our agricultural agencies for the purpose of intelligently executing such plans as may seem to be wise. We shall attempt not only to perfect the organization and cooperation of the Department of Agriculture, the agricultural colleges and State departments, and the farmers' organizations, but we shall especially labor to strengthen the local farm bureaus and other organizations which support so effectively the extension forces and assist them in their activities. This is highly desirable not only during the continuance of present abnormal conditions but also for the future. The local as well as the State and Federal agencies are of supreme importance to the Nation in all its activities designed to make rural life more profitable, healthful, and attractive, and, therefore, to

secure adequate economic production, efficient distribution, and necessary conservation.

The Department of Agriculture, the agricultural colleges, and other organizations will continue to give definite thought to all the problems, will keep close track of developments, and, at the proper time in advance of the next planting season, will lay the situation before the farmers of the Nation. They will attempt to outline the needs and to suggest particular crops the increased production of which should be emphasized.

COOPERATION OF OFFICIAL AGENCIES.

To aid in securing larger production and fuller conservation during 1917 and 1918, the Department and the State colleges and commissioners of agriculture were in cordial cooperation. I can not adequately express my appreciation of the spirit which the State officials manifested in placing themselves at the service of the Government and of the extent, variety, and effectiveness of their efforts in every undertaking. The authorities and staffs of the agricultural colleges in every State of the Union placed their facilities at the disposal of the Department, supported its efforts and plans with the utmost zeal, and omitted no opportunity, on their own initiative, to adopt and prosecute helpful measures and to urge the best agricultural practice suited to their localities. They not only responded promptly to every request made on them to cooperate in the execution of plans but also liberally made available to the Department the services of many of their most efficient officers. Equally generous was the support of the great agricultural journals of the Union. They gladly sent their representatives to attend conferences called by the Federal Department and through their columns rendered vast service in the dissemination of information.

Very much assistance also was received from the National Agricultural Advisory Committee, created jointly by the Secretary of Agriculture and the Food Administrator for the purpose of securing the views of farmers and farm organizations and of seeing that nothing was omitted to safeguard all legitimate interests. This body, as a whole and also through its subcommittees, studied the larger and more critical agricultural problems confronting the Government, gave many valuable criticisms and highly useful suggestions, and assisted in the several communities in making known the plans and purposes of the Department. The committee included, in addition to representative farmers, the heads of a number of the leading farm organizations. It was composed of former Gov. Henry C. Stuart, of Virginia, a farmer and cattleman and member of the price-fixing committee of the War Industries Board, giving special attention to the consideration of price activities bearing on farm products; Oliver Wilson, of Illinois, farmer and master of the National Grange; C. S. Barrett, of Georgia, president of the Farmers' Educational and Cooperative Union; D. O. Mahoney, of Wisconsin, farmer specializing in cigar leaf tobacco and president of the American Society of Equity; Milo D. Campbell, of Michigan, president of the National Milk Producers' Federation; Eugene D. Funk, of Illinois, ex-President of the National Grain Association and president of the National Corn Association; N. H. Gentry, of Missouri, interested in swine production and improvement and vice president of the American Berkshire Association; Frank J. Hagenbarth, of Idaho, cattle and sheep grower and president of the National Wool Growers' Association; Elbert S. Brigham, of Vermont, dairyman and commissioner of agriculture; W. L. Brown, of Kansas, wheat grower and member of the State board of agriculture; David R. Coker, of South Carolina, chairman of the State council of defense,

successful cotton farmer, and producer of improved types of cotton; W. R. Dodson, of Louisiana, farmer and dean of the Louisiana College of Agriculture; Wesley G. Gordon, of Tennessee, demonstrator of better farming and influential in promoting the introduction of crimson clover and other legumes in his State; John Grattan, of Colorado, agricultural editor, member of the Grange and Farmers' Union, and cattle feeder; J. N. Hagan, of North Dakota, general farmer planting spring wheat on a large scale and commissioner of agriculture and labor; W. W. Harrah, of Oregon, wheat grower, director of the Farmers' Union Grain Agency of Pendleton, and member of the Farmers' Educational and Cooperative Union; C. W. Hunt, of Iowa, general farmer and large corn planter and live-stock producer; H. W. Jeffers, of New Jersey, dairyman, president of the Walker-Gordon Laboratory Co., and member of the State board of agriculture; Isaac Lincoln, of South Dakota, banker and successful grower on a large scale of special varieties of seed grains; David M. Massie, of Ohio, general farmer and successful business man, interested particularly in farm management; William F. Pratt, of New York, general farmer, agricultural representative on the board of trustees of Cornell University, and member of the State Farm and Markets Council; George C. Roeding, of California, fruit grower, nurseryman, and irrigation farmer, and president of the State agricultural society; Marion Sansom, of Texas, cattleman, live-stock merchant, and director of the Federal reserve bank at Dallas; and C. J. Tyson, of Pennsylvania, general farmer and fruit grower and former president of the Pennsylvania State Horticultural Association.

COOPERATIVE EXTENSION SERVICE.

The emergency through which the Nation has passed only served to emphasize the supreme importance of the Cooperative Agricultural Extension Service. It has become increas-

ingly clear that no more important piece of educational extension machinery has ever been created. It has been amply demonstrated that the most effective means of getting information to the farmers and their families and of securing the application of the best scientific and practical processes is through the direct touch of well-trained men and women. With additional funds made available through the regular agricultural extension act, and especially through the emergency food-production measure, the Department, in cooperation with the State colleges, quickly took steps to expand the extension forces with a view to place in each rural county one or more agents. When this Nation entered the war in April, 1917, there was a total of 2,149 men and women employed in county, home demonstration, and boys' and girls' club work, distributed as follows: County agent work, 1,461; home demonstration work, 545; boys' and girls' club work, 143. In November of this year the number had increased to 5,218, of which 1,513 belong to the regular staff and 3,705 to the emergency force. There were 2,732 in the county agent service, 1,724 in the home demonstration work, and 762 in the boys' and girls' club activities. This does not include the larger number of specialists assigned by the Department and the colleges to aid the extension workers in the field and to supplement their efforts.

It would be almost easier to tell what these men and women did not do than to indicate the variety and extent of their operations. They have actively labored not only to further the plans for increased economical production along all lines and carried to the rural population the latest and best information bearing on agriculture, but also to secure the conservation of foods and feeds on the farm; and, in addition, many of them have aided in the task of promoting the better utilization of food products in the cities. They constitute the only Federal machinery in intimate touch with the millions of people in the farming districts. They have,

therefore, been able to render great service to other branches of the Government, such as the Treasury in its Liberty Loan campaigns, the Red Cross, the Young Men's Christian Association, and other organizations in their war activities, and the Food Administration in its special tasks.

WORK OF THE DEPARTMENT.

It would require a volume even to outline all the things which the Department of Agriculture has done. It stimulated production, increasingly controlled plant and animal diseases, reducing losses from the cattle tick, hog cholera, tuberculosis, predatory animals, and crop pests, and, in conjunction with the Department of Labor, rendered assistance to the farmers in securing labor. It safeguarded seed stocks and secured and distributed good seeds to farmers for cash at cost; acted jointly with the Treasury Department in making loans from the President's special fund to distressed farmers in drouth-stricken sections; aided in transporting stock from the drouth areas; greatly assisted in the marketing of farm products, and, under enormous difficulties, helped the farmers to secure a larger supply of fertilizers. At the direction of the President, it is administering under license the control of the stockyards and of the ammonia, fertilizer, and farm-equipment industries.

The Department maintained intimate touch with the War and Navy Departments, the War Industries, War Trade, and Shipping Boards, and the Fuel and Food Administrations. Through the Bureau of Animal Industry, it not only continued to safeguard the meat supply for the civilian population, but it also inspected the meats used at the various cantonments, training camps, forts, posts, and naval stations, and aided in the organization of the veterinary corps. Through the Forest Service it rendered valuable assistance to practically all branches of the Government having to do with the purchase or use of forest products and to many in-

dustries which supply war material to the Government, made a thorough study of the lumber situation, aided in many directions the Bureau of Aircraft Production and the Navy Department in the execution of their aeroplane programs, conducted cooperative tests on a large scale at the Forest Products Laboratory, and collaborated in the organization of the forestry regiments. Its Bureau of Markets handled the distribution of nitrate of soda to farmers for cash at cost, cooperated with the War Industries Board in broadening the channels of distribution and stimulating the use of stocks of low-grade cotton, and worked with the Food Administration in the handling of grains and in other of its activities. Its Bureau of Chemistry assisted other departments in preparing specifications for articles needed by them, aided the War Department in the organization of its chemical research work and in making tests of fabrics and supplies, worked out formulas for waterproofing leather, and maintained intimate touch with the related services of the Food Administration. The Department collaborated with the War Department in its handling of the draft, with special reference to its problem of leaving on the farms the indispensable skilled agricultural laborers. In like manner, through the States Relations Service and the Bureaus of Soils, Roads, Biology, and Entomology, the Department's services have been freely extended to other branches of the Government. It would be impossible in reasonable space to indicate its participation in all directions, and reference must therefore be made to reports of the several bureaus.

MEAT SUPPLY.

Farm animals and their products received a large share of the Department's attention. Efforts were directed toward increasing the output of meat, milk, butter, and other fats, cheese, poultry, eggs, wool, and hides, first, by encouraging

the live-stock raiser to make a direct increase in his herds and flocks and their products and, second, by assisting him to prevent loss from disease.

The campaigns for increased production yielded especially fruitful results in respect to pigs and poultry. Indications are that the increase of 15 per cent in pork production this year over 1917, asked for by the Food Administration, will be realized, at least in weight if not in number of hogs. Poultry and eggs also show a material increase, and enormous quantities of the latter were preserved by householders in the season of plenty for use in time of scarcity.

Steps were taken also to encourage the growing of cattle and sheep, but results are naturally slower with these animals than with pigs and poultry. Stockmen in all parts of the country were urged to carry sufficient numbers of cattle in order to make the fullest possible use of pastures and feeds which otherwise would have been wasted; cattle feeders were advised how to save certain grain for human consumption by substituting other feeds for their stock, and efforts were continued to bring about an increase in the number of cattle in the areas freed from ticks.

Through the joint action of the Bureaus of Animal Industry and Markets and the States Relations Service valuable assistance was rendered in the movement of cattle from the drouth-stricken areas of Texas. The county agents in that State, cooperating with the extension workers in Louisiana, Alabama, Georgia, Oklahoma, Mississippi, Arkansas, and Florida, and with the agents of the other bureaus mentioned, indicated to farmers in regions of heavy crop production the manner in which the cattle could be obtained from the distressed sections and have greatly aided in arranging for their transportation. As a result of their efforts it is estimated that approximately 300,000 head of cattle were saved from starvation or premature slaughter.

OVERCOMING ANIMAL DISEASES.

The increasing control and eradication of animal diseases stimulated production on a more economical basis. For years the Department has been carrying on such work, but during the past year its efforts were greatly extended and more vigorously prosecuted with unusually favorable results.

THE CATTLE TICK.—The progress made in the eradication of the southern cattle ticks led to the release from quarantine of 67,308 square miles, the largest area freed in any year since the beginning of the work in 1906. The total free area is now 379,312 square miles, or 52 per cent of that originally quarantined; and the work of the past summer will result in the addition of 79,217 more on December 1. The release of the remainder of the State of Mississippi since my last report makes the first strip of uninfested territory from the interior to the Gulf of Mexico, and the proposed action on December 1 will liberate the entire State of South Carolina, thus opening a broad avenue of free territory to the Atlantic Ocean.

The method of eradication employed is the systematic and regular dipping, throughout the season, in a standard arsenical solution, of all cattle in a community. The cost has been from 18 to 50 cents a head, while the enhanced value of each animal greatly exceeds this, one canvass having shown an estimated average increase of \$9.76. The eradication of the ticks not only prevents heavy losses, but also permits the raising of high-class beef cattle and the development of dairying in sections where neither was before economically possible.

HOG CHOLERA.—The ravages of hog cholera, the greatest obstacle to increasing hog production, were greatly reduced as a result of the cooperative campaign conducted in 33 States. The methods of control involved farm sanitation, quarantine, and the application of anti-hog-cholera serum. Data compiled by the Department show that the losses from

hog cholera in the year ending March 31, 1918, amounted to only \$32,000,000, as compared with \$75,000,000 in 1914, a reduction of more than 50 per cent in less than five years. Stated in another way, the death rate from hog cholera in the United States was 144 per thousand in 1897, 118 in 1914, and only 42 in 1917, the lowest in 35 years.

The protective serum was used also at public stockyards during the last year. Among the hogs received at market centers there are many which are too light in weight for slaughtering and which should be sent back to farms for further growth and fattening. Formerly, because of the danger of spreading cholera, the Department would not allow hogs to leave public stockyards except for immediate slaughter. The result was that all light-weight hogs sent to the markets were slaughtered. Some of these were young sows suitable for breeding. Now the Bureau of Animal Industry treats these immature pigs with serum and allows them to be shipped out as stockers and feeders. During the past year more than 250,000 head were handled in this way. Their average weight was approximately 100 pounds. It is probable that practically all of them were returned to the markets later at an average weight of 250 to 275 pounds, making an aggregate gain of about 40,000,000 pounds of pork.

TUBERCULOSIS.—Tuberculosis, the most widely distributed destructive disease that now menaces the live-stock industry, recently was made a special object of attack. In cooperation with State authorities and live-stock owners, a campaign was undertaken in 40 States to eradicate tuberculosis from herds of pure-bred cattle, from swine, and in selected areas. At present our efforts are concentrated on the first project, since the pure-bred herds are the foundation of our breeding stock. A plan adopted in December, 1917, by the United States Live Stock Sanitary Association and representatives of breeders' associations, and approved by the

Department, was put into operation with the assistance of a large number of herd owners. Herds are tested with tuberculin, and any diseased animals are removed and the premises cleaned and disinfected. Subsequent tests are made at proper intervals. By this means there is being established an accredited list of pure-bred herds from which breeding stock may be secured with reasonable assurance that it is free from tuberculosis. The first list, consisting of more than 1,000 names of owners of herds of pure-bred cattle, representing tests made up to the end of the fiscal year, was compiled and printed for distribution to breeders.

PARASITIC AND OTHER DISEASES.—Enlarged forces and more energetic measures brought further progress in the eradication of the parasitic diseases known as scabies or scab of sheep and cattle. These diseases now linger in only a few small areas. Aid was extended to the War Department and to State and local authorities in reducing and preventing losses from influenza or shipping fever of horses, which has been very prevalent among animals collected for Army purposes. Greater efforts were put forth also to control, reduce, and prevent blackleg, anthrax, hemorrhagic septicemia, contagious abortion, dourine, parasites, plant poisoning, and other diseases which operate to reduce live-stock production.

PREDATORY ANIMALS.

The increasing control and destruction of predatory animals had a direct bearing on live-stock production. During the year there were captured and killed 849 wolves, 26,241 coyotes, 85 mountain lions, and 3,462 bobcats and lynxes. It is estimated that the destruction of these pests resulted in a saving of live stock valued at \$2,376,650.

The cooperative State campaigns organized to exterminate native rodents, mainly prairie dogs, ground squirrels, pocket gophers, and jack rabbits, which annually destroy \$150,000,000 worth of food and feed products, proved to be practi-

cal and of great immediate value in increasing grain and forage production. To destroy ground squirrels and prairie dogs on more than 3,295,000 acres of agricultural lands in Montana, 15,865 farmers distributed 276 tons of poisoned grain prepared under direction, while in North Dakota 34,796 treated once approximately 5,430,000 acres and a second time over 7,000,000 acres covered in similar campaigns during the preceding two years. In Idaho the work has been in progress in 22 counties, with more than 4,000 farmers and officials assisting; and it is planned to include every county in the State next year. Similar work was organized and is in progress in Washington, Oregon, Wyoming, Utah, Colorado, Nevada, California, Arizona, and New Mexico in cooperation with agricultural college extension departments, State councils of defense, and other local organizations. Several million bushels of grain and much hay and forage were saved through these efforts, which will be continued on an enlarged scale during the coming year.

NATIONAL FOREST RANGES.

A very material increase was brought about in the production of meat and wool on the forest ranges. Careful observation of range conditions and study of the methods which would secure the most complete utilization of the forage disclosed that a very considerable increase in the number of animals was possible without overgrazing the forests. The number of cattle under permit for the 1918 season was nearly 2,140,000, and of sheep more than 8,450,000. In two years there were placed on the forests approximately 1,000,000 additional head of live stock, representing about 25,000,000 pounds of beef, 16,000,000 of mutton, and 4,000,000 of wool.

The season of 1918 strikingly illustrated the advantages which the National Forest ranges offer to the western livestock industry. Throughout the West the ranges outside the

forests were generally in bad shape on account of drouth conditions. The live-stock business is becoming precarious for owners who are dependent upon the open public range; many are closing out, and the number of range stock is being reduced. On the other hand, the use of the National Forest ranges is increasing and their productivity is rising under the system of regulation. Never was the wisdom of Government control of these ranges more manifest than at the present time.

DAIRY PRODUCTS.

The Department endeavored to bring about an increase in the output of dairy products by means of more and better cows, improved methods and practices, and the extension of dairying in sections where the industry had not been fully developed. Continued encouragement was given to the development of the dairy industry in Southern and Western States, to the organization and operation of cheese factories in the mountainous regions of the South, and to the building of silos as a means of providing winter feed.

The food value of dairy products was brought to the attention of the consuming public and their economical use advocated. An extensive campaign was waged to encourage the production and consumption of cottage cheese as a means of utilizing for human food skim milk and buttermilk, large quantities of which ordinarily are fed to live stock or are wasted. Printed matter on the nutritional value of cottage cheese and on the methods of making it was issued in large editions and widely circulated, in cooperation with State extension organizations, and specialists were sent out to encourage its production and consumption.

THE FEDERAL MEAT INSPECTION.

The Federal meat-inspection service covered 884 establishments in 253 cities and towns. There were slaughtered under inspection 10,938,287 cattle, 3,323,079 calves, 8,769,498

sheep, 149,503 goats, and 35,449,247 swine, a total of 58,629,612 animals. Compared with the preceding fiscal year, these figures represent a decline of 5,000,000 in the total number of animals, but an increase of nearly 1,750,000 cattle and more than 600,000 calves. Condemnations amounted to 206,265 animals or carcasses and 528,481 parts of carcasses. The supervision of meats and products prepared and processed covered 7,905,184,924 pounds, and resulted in the condemnation of 17,543,184 pounds. There were certified for export 2,510,446,802 pounds of meat and meat food products.

GOOD FOOD FOR SOLDIERS AND SAILORS.

At the request of the Secretary of War and the Secretary of the Navy, the Department participated in protecting our military and naval forces against unwholesome foods. The Federal meat inspection, which for years has safeguarded the civil population of the United States from bad meat in interstate commerce, was extended to include the special supervision of the meat supply of the American Army and Navy. The examination, selection, and handling of meats and fats are in expert hands from the time the live animals are driven to slaughter until the finished product is delivered in good condition to the mess cooks. Inspectors were assigned to the various cantonments, training camps, forts, posts, and other places in the United States where large numbers of troops are assembled and, at the close of the fiscal year, there were 69 such experts with the Army and 30 with the Navy.

MARKET NEWS SERVICES.

As soon as the appropriations under the food production act became available steps were taken to expand much of the regular work of the Bureau of Markets and to institute certain new lines. The Market News Services, which had been established on a relatively small scale, were greatly

enlarged until at the close of the fiscal year there were approximately 90 branch offices distributing market information to all sections of the country over practically 14,000 miles of leased wires. Many producers, distributors, and others have come to depend on these services and to make less use of commercial price-quoting agencies, which are not able to furnish data so reliable, accurate, prompt, and comprehensive.

FRUITS AND VEGETABLES.

An organization was built up for the national interchange of market information on fruits and vegetables, and the news service on these products was made continuous throughout the year for the first time since it was instituted. Reports were issued in season covering approximately 32 commodities and indicating daily car-lot shipments, the jobbing prices in the principal markets throughout the country, and other shipping-point facts for these crops. In addition to the permanent market stations opened during the period of important crop movements temporary field stations were operated at 82 points in various producing sections, more than twice as many as in the preceding year.

LIVE STOCK AND MEATS.

The news service on live stock and meats was extended to include additional important live stock and meat marketing centers and producing districts. New features also were added to make the service more useful to producers and the trade. The daily reports on meat-trade conditions, which formerly gave information on the demand, supplies, and wholesale prices of western dressed fresh meats in four of the most important eastern markets, now cover also Los Angeles, San Francisco, and Pittsburgh. As a supplement to the daily reports, a weekly review is published. The daily telegraphic report on live-stock shipments west of the Allegheny Mountains was expanded to include all live stock

loaded on railroads throughout the United States. Information regarding the "in" and "out" movement in certain feeding districts is being published. This work is valuable in indicating the potential meat supply of the country and will be developed as rapidly as available funds permit.

On June 1, 1918, the Department took over the furnishing of all telegraphic market reports distributed daily from the Chicago Union Stock Yards on live-stock receipts and prices, including not only those regularly sent over the leased wire of the Bureau of Markets but all reports used by commercial news agencies and press associations. The substitution of a Government report for the previous unofficial service has exerted a material influence in restoring confidence in the reports of market conditions, the lack of which has been a fundamental obstacle to the economic development of the live-stock industry.

DAIRY AND POULTRY PRODUCTS.

The news service on dairy and poultry products gives prices of butter, eggs, and cheese, trade conditions, market receipts, storage movement, and supplies in storage and in the hands of wholesalers and jobbers. Since the fall of 1917 it has covered Washington, Boston, New York, Philadelphia, Chicago, Minneapolis, and San Francisco. Data were secured each month from approximately 14,000 dairy manufacturing plants in the United States, showing the quantities produced of such products as whey, process butter, oleomargarine, cheese of different kinds, condensed and evaporated milk, various classes of powdered milk, casein, and milk sugar.

GRAIN, HAY, AND FEED.

Biweekly statements on the stocks of grain, hay, and feed, the supply of and demand for these commodities, and the prices at which they were being bought and sold in carload

lots, were issued from New York, Richmond, Atlanta, Chicago, Minneapolis, Kansas City, Oklahoma, Denver, Spokane, and San Francisco.

Through the machinery of these services, emergency work of special value was conducted. At the request of the Director General of Railroads, a survey was made to determine the exact location of the soft corn in the United States and the number of freight cars needed to move it; and, at the request of the Food Administration, the feed requirements of New York, Pennsylvania, and New England were ascertained. Temporary offices were opened in the drouth-stricken regions at Fort Worth, Tex., Bismarck, N. Dak., and Bozeman, Mont., to assist farmers and cattle raisers in securing supplies of feed, and aid was thus given in saving thousands of cattle from starvation or premature slaughter.

SEEDS.

Although it has been apparent for several years that it would be extremely desirable to have available more dependable and complete information on seed-marketing conditions, the situation did not become acute until war was declared. To meet the conditions then encountered, field offices were opened in Chicago, Minneapolis, Kansas City, Atlanta, Spokane, San Francisco, and Denver. Information obtained through them and through voluntary reporters throughout the country is disseminated by means of a monthly publication entitled "The Seed Reporter." The workers connected with this service have cooperated fully with the seed-stocks committee of the Department in furthering effective seed distribution.

LOCAL MARKET REPORTING SERVICE.

What is known as the Local Market Reporting Service covers an entirely new field and is a logical and necessary supplement to the national telegraphic news services. The

first experiment was made in Providence, R. I., shortly before the beginning of the last fiscal year and was so successful that, when emergency funds became available, the work was broadened and, in cooperation with local authorities, agents were placed in 15 additional cities. This service consists largely of reports on local market conditions and prices based on daily observations and is conducted primarily for the benefit of growers and consumers, though it is also very useful to dealers. Consumers' figures are made public through the local newspapers and are helpful guides for the housewife. The growers' reports contain brief discussions of market features, changes, and developments, and give tables showing prices received by producers for certain products and, as well, those of wholesale and commission dealers.

INSPECTION OF FOOD PRODUCTS.

Since the fall of 1917 the Department, through the Food Products Inspection Service, has made it possible for shippers to receive certificates from disinterested Federal representatives as to the condition of their fruit and vegetable shipments upon arrival at large central markets. There are now inspectors in 36 of the most important markets of the country. As a result of their activities, perishable foodstuffs entered more quickly into the channels of consumption, cars were released more promptly, and many rejections and reversions prevented. The service was used extensively by the Food Administration and by the Army and Navy in connection with their purchases of food supplies. Inspections are now made not only at the request of shippers but also of receivers and other interested parties.

Owing to the ever-increasing distance between important producing sections and large consuming centers, the question of the conservation of food, both in transportation and storage, has become a vital one. During the past year the results obtained in previous investigational work along these

lines were made the basis of extensive demonstrations. Producers were given practical advice regarding the proper methods of picking, grading, packing, handling, storing and shipping the more perishable products, such as fruits and vegetables. The proper construction not only of storage houses but also of refrigerator and heater cars was carefully studied, and the recommendations of the Bureau of Markets on car construction were accepted by the Railroad Administration and other agencies.

UNITED STATES GRAIN STANDARDS ACT.

The activities necessary to enforce the United States grain standards act were greatly increased during the year. The minimum guaranteed price fixed by the President was based upon the official standards established and promulgated by the Department, effective for winter wheat on July 1 and for spring wheat on August 1, 1918. Until 1917 fixed prices and restricted trading were features unknown in the history of grain marketing, and the wheat crop of that year was the first to be marketed under Federal standards and in compliance with the requirements of the act. Under these extraordinary conditions it was found necessary to revise the Federal wheat standards. This was done after hearings had been held throughout the country, to which producers, country shippers, grain dealers, and all other grain interests were invited. The revised standards harmonize as closely as possible with the desires of producers and consumers, and at the same time preserve fundamental grading principles. A minor revision of the official standards for shelled corn also was made, effective July 15, 1918.

Prior to July 1, 1917, appeals from grades assigned to grain by licensed inspectors could be entertained by the Department only in reference to shelled corn. After that date appeals from the grades assigned to wheat by such inspectors were considered, thus greatly broadening the scope

of the Department's grain-grading activities. Under Government control the price of wheat depends entirely upon its grade, and this fact stimulated appeals for the determination of the true grade. During the period covered by this report approximately 1,250 appeals were taken. This is an increase of more than 100 per cent over the number in the preceding year. Under cooperative arrangements with the Food Administration the services of the grain supervisors of the Department were made available to the United States Grain Corporation in matters pertaining to the grading of grain under its jurisdiction. Grade determinations made in this way extended into the thousands. Wheat moving to large terminal markets was inspected and graded by inspectors licensed by the Department under the grain standards act, and the responsibility of the Department, therefore, with respect to the efficiency of the work of licensed inspectors was greatly enhanced. The records of the Department show that considerable progress was made in this direction, and the methods of supervising the work of licensed inspectors recently adopted should secure further improvement. The demand for the official inspection of grain is steadily increasing. There are now 330 licensed inspectors and 120 inspection points, and within the fiscal year 438,703 cars of corn and 337,344 cars of wheat were graded under the act.

DISTRIBUTION OF LOW-GRADE COTTON.

It has been very difficult to obtain correct commercial differences for cotton during the past season owing to the great demand for the high grades and the falling off of that for the low grades. To add to the difficulty, the latter become concentrated at a limited number of designated spot markets. These markets endeavored to submit correct quotations for them, while other markets were at a loss as to how to arrive at correct differences. This caused some markets to quote the very low grades at a much wider discount

than others. The apparent result was that the average differences for these grades were comparatively so narrow as to make their delivery on future contracts very profitable. A further result was that the parity between spot cotton and future cotton was greatly disturbed, future contracts depreciating in value on account of the comparatively high prices at which the low-grade product was delivered on them.

Realizing that it was economically unsound for an appreciable portion of the crop practically to become dead stock and to be excluded from use, this Department took steps to secure its proper utilization, particularly through a modification of Government contracts. It was believed to be feasible to use lower grade cotton without reducing the serviceability of the manufactured fabric. Steps were taken also, through cooperation with the designated spot markets, to assure the accuracy of quotations. It may be desirable to amend the rules for obtaining differences in order to secure more nearly accurate quotations for the grades of which some markets may from time to time become bare. The possibility of formulating a workable plan is being considered.

THE PINK BOLLWORM OF COTTON.

Attention was called last year to the establishment in the Laguna, the principal cotton-growing district of Mexico, of the pink bollworm of cotton. The quarantine action as to Mexican cotton and cotton seed, as well as the provision for a very complete Mexican border control service, was then noted, and reference also was made to the clean-up operations with the mills in Texas which, prior to the discovery of this insect in Mexico, received Mexican cotton seed for crushing.

There were three points of infestation in Texas last year, at Hearne, Beaumont, and the much larger Trinity Bay district. They are under effective control. No additional areas have been found.

The Trinity Bay infestation was the most serious, covering 6,000 acres. It undoubtedly was not due to the importation of cotton seed from Mexico prior to the establishment of the quarantine in 1916. The insect has been present there for three or four years, and it must have been introduced either through some importation of foreign cotton seed in violation of the Federal quarantine, or, as seems more probable, through storm-distributed cotton or cotton seed from Mexico. Following the great storm of 1915, cotton lint and cotton seed, some of which came from the Laguna, Mexico, were observed quite generally about the shores of the bay. The distribution of the insect, as determined in the survey and clean-up work of the fall and winter of 1917-18, strongly supports this theory of origin.

The State of Texas, under the authority of the cotton quarantine act passed by the special session of the State legislature on October 3, 1917, cooperated very materially in the work of extermination. The small district at Hearne, Tex., and the important Trinity Bay region, including Beaumont, involving in whole or in part eight counties in Texas, were placed under quarantine by the State and the growing of cotton in these districts prohibited for a period of three years or longer.

The eradication operations of last fall and winter included the infested and noninfested cotton fields and were carried out, in cooperation with the State of Texas, under special appropriations to the Department of \$50,000, available March 4, 1917, and \$250,000, available October 6, 1917. All standing cotton was uprooted and burned, and scattered bolls and parts of plants were also collected and burned. The seed was milled under proper safeguards and the lint shipped from Galveston to Europe. In the Trinity Bay and Beaumont districts, a total of 8,794 acres of cotton land was cleaned at an average labor cost of \$9.94 per acre.

In addition to these two quarantined areas a border district, comprising the counties of Kinney, Maverick, and Valverde, was placed under control by proclamation of the Governor of Texas. This action was taken because of the infestation of cotton lands in Mexico, nearly opposite Eagle Pass, within 25 miles of the Texas border. The growing of cotton in these counties and its transportation from them are forbidden under the terms of the quarantine for a term of three years or more.

The most encouraging feature of the year's work is the fact that not a single egg, larva, or moth of the pest was found within either of the quarantined areas, or elsewhere in Texas, during the season of 1918. This would seem to indicate the effectiveness of the operations of last year and furnishes reason for expecting the complete extermination of the insect. If this result is achieved, it will be the largest successful entomological experiment of the kind in history.

TEXAS BORDER QUARANTINE SERVICE.

The regulation of the entry into the United States from Mexico of railway cars and other vehicles, freight, express, baggage, and other materials, and their inspection, cleaning, and disinfection, was continued during the year with a view to prevent the accidental movement of cotton and cotton seed. This service covers the ports of El Paso, Laredo, Del Rio, Eagle Pass, and Brownsville. During the year 25,257 cars have been inspected and passed for entrance into this country.

The general presence of cotton seed necessitated the fumigation of practically all cars and freight coming from Mexico, with the exception of certain cars used for the shipment of ore and lumber. These cars were offered for entry principally at the port of El Paso, and, under arrangement with the importing companies, were thoroughly cleaned of cotton seed at the point of origin before loading, and so certified.

At present the best available means of disinfection involves the use of hydrocyanic-acid gas generated within the cars. This method, however, is unsatisfactory on account of the poor condition of the cars and the fact that it does not destroy insects which may be resting on the exterior. In the circumstances, it was necessary to provide for the requisite disinfection in specially constructed houses capable of containing one or more cars at a time. Contracts have been let for five such houses at the ports indicated, and their construction is now well under way. At Del Rio no railroad crosses the border, and a building is being erected to take care of traffic in wagons and motor trucks. Each structure is provided with a system of generators in which hydrocyanic-acid gas is produced. The expense of disinfection will be assumed by the Department, and a charge will be made only to cover the cost of the labor, other than supervision, and of the chemicals used. Under the law the moneys so received must be turned into the Treasury of the United States. This will result in a very considerable depletion of the appropriation available for the work, and it will, therefore, be necessary to ask Congress for an emergency appropriation to reimburse the fund thus expended.

THE SITUATION IN MEXICO.

The situation in Mexico, as determined by surveys conducted during the last two years, seems to confirm the view that the infestation there is limited to the Laguna district and to two small isolated areas opposite Eagle Pass, Tex. This indicates a much more favorable outlook for the possible future extermination of the insect in Mexico than had been anticipated.

The experiment station established last year by the Department in the Laguna district to study the problem and to conduct field experiments with reference to the substitution of other crops for cotton secured much needed information

relating to the habits and food plants of the insect. This information will be very useful in determining the most efficient means of eradication and of preventing the spread of the pest. The wheat and corn crops of the Laguna this year have been unusually successful, and the peanuts and castor-bean crops have given good promise.

NURSERY STOCK IMPORTATIONS.

The need of additional restrictions on the entry into this country of certain classes of nursery stock and other plants and seeds has been under consideration. The danger of introducing destructive diseases with plants having earth about the roots and plants and seeds of all kinds for propagation from little-known or little-explored countries is especially great. The large risks from importations of these two classes arise from the impossibility of properly inspecting the former and from the dangers which can not be foreseen with respect to the latter. Examination of such material is necessarily difficult, and the discovery of infesting insects, particularly if hidden in bark or wood, or of evidences of disease is largely a matter of chance. Such control, therefore, as a condition of entry is a very imperfect safeguard.

There has developed throughout the country a wide interest in the subject which has manifested itself in numerous requests from official bodies all over the Union for greater restriction on plant imports. As a basis for such additional restrictions, a public hearing was held in May at which the whole subject was fully discussed with all of the interests concerned. As a result, it is proposed to issue a quarantine which shall restrict the entry of foreign plants and seeds for propagation substantially to field, vegetable, and flower seeds, certain bulbs, rose stocks, and fruit stocks, cuttings, and scions. The entry of these classes of plants is represented to be essential to the floriculture and horticulture of this country.

CITRUS CANKER.

Since the autumn of 1914 the Department has cooperated with the Gulf States in a campaign to eradicate the canker disease of citrus fruit and trees. Notwithstanding its wide dissemination before its identity and nature were determined, the progress of the work has been very satisfactory. There appears to be no doubt that the few infections occurring in South Carolina and Georgia have been located and eradicated, so that further work in these States will not be necessary. The extent of the disease in Florida, where the citrus industry is of great magnitude, has been very greatly reduced. In that State, where the total number of properties found to be infected was 479, scattered through 22 counties, the number remaining under quarantine has been reduced to 47. Only 15 canker-infected trees were discovered during the first six months of 1918. The malady is of such highly infectious and virulent nature, however, that it will be necessary to continue the work in all the citrus-growing areas of the State for some time after the orchards appear to be clean in order to prevent the possibility of outbreaks from any latent or inconspicuous infection that might have escaped the observation of the forces. In Alabama, Mississippi, Louisiana, and Texas it is believed that any further seriously destructive outbreaks of canker can be prevented.

CROP ESTIMATES.

The Bureau of Crop Estimates rendered service of great value to the country by its regular monthly and annual crop reports and by its special inquiries for country-wide information relating to particular phases of agriculture urgently needed for immediate use by the Government. It systematically arranged and translated into American units probably the most complete collection of data in the world relating to the agriculture of foreign countries. Since the beginning of the European war, and more especially since the

entry of the United States, it has compiled many statistical statements regarding crop and live-stock production, imports, exports, per capita consumption, and estimated stocks on hand in foreign countries for the Department, the Food Administration, and the War Trade Board.

The Monthly Crop Reports, which include current estimates of acreages planted and harvested, growing condition, forecasts and estimates of yield per acre, total production and numbers of different classes of live stock, farm prices, stocks of grain remaining on farms, farm wages, and progress of farm work, were especially valuable. Upon the information contained in them was based much of the constructive work of the Department, the Food Administration, the State colleges of agriculture and experiment stations, and many State and local organizations interested in maintaining, conserving, marketing, and distributing the food supply.

For collecting original data the bureau has two main sources of information—voluntary reporters and salaried field agents. The voluntary force comprises 33,743 township reporters, one for each agricultural township; 2,752 county reporters, who report monthly or oftener on county-wide conditions, basing their estimates on personal observation, inquiry, and written reports of aids, of whom there are about 5,500; 19 special lists, aggregating 137,000 names, who report on particular products, such as live stock, cotton, wool, rice, tobacco, potatoes, apples, peanuts, beans, and the like; and 20,160 field aids, including the best informed men in each State, who report directly to the salaried field agents of the bureau. The total voluntary staff, therefore, numbers approximately 200,000, an average of about 66 for each county and 4 for each township. The reporters, as a rule, are farmers. They serve without compensation, and are selected and retained on the lists because of their knowledge of local conditions, their public spirit, and their interest in

the work. All except county and field aids report directly to the bureau, and each class of reports is tabulated and averaged separately for each crop and State.

The bureau has 42 salaried field agents, one stationed permanently in each of the principal States or group of small States, and 11 crop specialists. These employees are in the classified civil service. All have had some practical experience in farming. Most of them are graduates of agricultural colleges, and are trained in statistical methods and crop estimating. They travel approximately three weeks each month, the fourth week being required for tabulating and summarizing the data collected. They send their reports directly to the Department in special envelopes or telegraph them in code. These are carefully safeguarded until the Crop Report is issued.

Additional information is secured from the Weather Bureau, the Bureau of the Census, State tax assessors, thrashers, grain mills and elevators, grain transportation lines, the principal live-stock markets, boards of trade and chambers of commerce, growers and shippers' associations, and various private crop estimating agencies. Specific reports from the field service are assembled in Washington, tabulated, averaged, and summarized separately for each source, each crop, and each State. The resulting figures are checked against one another and against similar data for the previous month, for the same month of the previous year, and for the average of the same month for the previous 10 years; and a separate and independent estimate for each crop and State is made by each member of the crop reporting board, after which the board agrees upon and adopts a single figure for each crop and State.

This, in brief, is an outline of the organization and system which has been developed in the Department through more than half a century of experience in crop estimating, and indicates the care and thoroughness with which Government

crop reports are prepared. Because the monthly Government crop reports and annual estimates are fundamentally important as the basis of programs of the Department and the State colleges of agriculture for crop and live-stock production, marketing, distribution, and conservation, for the promotion of agriculture as an industry, for the guidance of individual farmers, for appropriate national and State legislation affecting agriculture and the food supply, it is believed that the crop-reporting service should be strengthened. This should be done through estimates by counties as well as by States. Then a near approach to census completeness and accuracy could be made, especially with reference to crop acreages and numbers of live stock; a clearer differentiation between total production and the commercial surplus would be possible, and the Department would be better able to analyze, chart, and report country and world-wide agricultural conditions with special reference to surplus and deficient crop and live stock production.

SEED-GRAIN LOANS IN DROUTH AREAS.

Acting upon urgent representations that many wheat growers in certain sections of the West who lost two successive crops by winter killing and drouth had exhausted their resources and might be compelled to forego fall planting and, in some cases, to abandon their homes unless immediate assistance was extended, the President, at my suggestion, on July 27 placed \$5,000,000 at the disposal of the Treasury Department and the Department of Agriculture to enable them to furnish aid to that extent. The primary object of this fund was not to stimulate the planting of an increased fall acreage of wheat in the severely affected drouth areas, or even necessarily to secure the planting of a normal acreage, but rather to assist in tiding the farmers over the period of stress, to enable them to remain on their farms, and to plant such acreage as might be deemed wise under all

conditions, with a view to increase the food supply of the Nation and to add to the national security and defense. It was distinctly not intended to be used to stimulate the planting of wheat or any other grain where such planting is not wise from an agricultural view and where other crops or activities are safer.

The Federal land banks of the districts embracing the affected areas were designated as the financial agents of the Government to make and collect the loans. The cooperation of local banks was sought and secured in the taking of applications and in the temporary financing of farmers pending advances of Federal funds upon approved applications and the execution of necessary papers.

Assistant Secretary G. I. Christie was designated to represent the Department of Agriculture in the Northwest, and Mr. Leon M. Estabrook, Chief of the Bureau of Crop Estimates, in the Southwest, in organizing the work and approving seed-loan applications. These officers were instructed to cooperate fully with the land banks in their districts acting for the Treasury Department. Several agronomists and field agents were detailed to assist each of this Department's representatives. The Northwest district included the western portion of North Dakota and portions of Montana and Washington; the Southwest district, portions of western Kansas, Oklahoma, Texas, and eastern New Mexico. Early in August headquarters were established at Great Falls, Mont., and at Wichita, Kans. Conferences were held with specialists of the State colleges of agriculture, and a list of counties was agreed upon in which it was deemed wise to make loans. County agents represented the Department of Agriculture in each county and, with the assistance of local inspection committees made up of members of county farm bureaus and county councils of defense, inspected the fields and verified the sworn statements of the applicants.

Loans were made only to farmers who, by reason of two successive crop failures resulting from drouth in the community, had exhausted their commercial credit. A limit of \$3 an acre on not more than 100 acres was fixed. The farmers agreed to use seed and methods approved by the Department. They signed a promissory note for the amount of the loan, with interest at the rate of 6 per cent, payable in the fall of 1919, and executed a mortgage giving the Government a first lien on the crop to be grown on the acreage specified. Furthermore, provision was made for a guarantee fund, each borrower agreeing to contribute 15 cents for each bushel in excess of a yield of 6 bushels per acre planted under the agreement. A maximum contribution of 75 cents per acre was fixed. The object of this fund is to safeguard the Government against loss. If it exceeds the loss it will be refunded pro rata to the contributors.

The demands for assistance were smaller than had been represented or anticipated. Estimates and suggestions for appropriations ranging from \$20,000,000 to \$40,000,000 had been made. Approximately 1,835 applications were approved in the Northwest for a total of \$371,198, and in the Southwest 8,806 for \$2,025,262, or a total of 10,641 applications, involving \$2,396,460. The number and amount for each State are:

State.	Number.	Amount.
Montana.....	1,480	\$300,919
North Dakota.....	338	65,944
Washington.....	17	4,335
Texas.....	1,336	292,651
Kansas.....	3,531	943,147
Oklahoma.....	3,852	773,271
New Mexico.....	87	16,193
Total.....	10,641	2,396,460

It was recognized that there were farmers in the Northwest who would probably be in even more urgent need of

assistance for their spring operations. As soon as it was seen that there would be a considerable unexpended balance from the fall planting activities, announcement was made that it would be expended for the spring planting of wheat. Since the cost of seeding spring wheat is greater than that for the fall, it was indicated that the loan would be made on the basis of \$5 an acre, with a limitation of 100 acres. It appears from a survey of the situation that the remainder of the fund will take care of the urgent cases.

The spirit of the farmers in both sections was exceptionally fine. Only those seem to have sought aid who could not otherwise remain on their farms and continue their operations. The number who appeared permanently to have abandoned their homes was relatively small. A considerable number of the men found temporary employment either in the industries of the West or on transportation lines, earning enough to provide for the subsistence of their families and to carry their live stock through the winter.

THE FARM-LABOR SUPPLY.

The Department of Agriculture continued throughout the year to give earnest attention to the securing and mobilization of an adequate supply of farm labor. It maintained its representatives, stationed in each State in the spring of 1917, and perfected its own organization, enlisting the more active cooperation of the county agents and other extension workers. It more fully coordinated its activities with the Department of Labor, a representative of this Department having been designated a member of the War Labor Policies Board which was created by the President. It also aided the War Department in connection with the classification of agricultural registrants. Special efforts were made, beginning early in the year, to impress upon the residents of urban communities the necessity of aiding farmers in the planting and harvesting of their crops. The response to appeals along this line

was generous. In Kansas, for example, where the situation was especially difficult, the reports indicate that more than 45,000 workers were supplied to farmers to assist in the wheat harvest. The potato crop in two counties in Texas was saved through the aid of the business men in the local communities, and in Illinois 35,000 workers were registered for harvest work. Many other examples could be cited, but the results of all these activities are clearly indicated by the fact that, although the largest acreage on record was planted, the great crops of the year were harvested under difficulties not appreciably greater than those in normal times.

PUBLICATION AND INFORMATION WORK.

The dissemination of useful and timely printed information in relation to agriculture is one of the prime functions of the Department. This is the task primarily of the Division of Publications and the Office of Information. It has reached great proportions. There were published during the year 2,546 documents of all kinds, the editions of which aggregated 97,259,399 copies, an increase of more than 51.6 per cent over the output of last year. This includes 341 earlier publications, the editions of which totaled 19,947,500, reprinted to supply the continuing demand, and 28,258,500 copies of emergency leaflets, pamphlets, posters, and the like issued in connection with the efforts of the Department to stimulate production. All previous records with regard to new Farmers' Bulletins were broken, 130 new bulletins in this series having been issued, the editions of which aggregated 10,815,000 copies. Of the 236 bulletins reprinted to supply the continuing demand, the editions reached 10,884,000 copies. The total issues of the bulletins in this series, therefore, amounted to 21,699,000 copies.

Noteworthy improvement in the character, form, and general appearance of the bulletins was accomplished during the year. Many of the earlier bulletins were revised and re-

duced, all extraneous matter eliminated, specific and positive statements substituted, and reprinted with attractive cover designs and text illustrations.

INFORMATION SERVICE.

To meet the increasing needs of the Department for publicity in its campaigns to stimulate food production and conservation, the services to the press of the country were largely extended. In addition to furnishing information to farmers through the agricultural and rural press, the Department has found it wise to present to people of the cities accurate statements of its recommendations and advice on the distribution and saving of food materials; and the work of the Department was enlarged to this end. An illustrated weekly news service is now furnished on request to 3,200 dailies and weeklies, which set the type in their own offices, through plate-making concerns to 250 papers, and to 4,000 smaller weeklies in ready print, a total of 7,450 publications. It is probable that this service reaches 15,000,000 to 20,000,000 readers weekly. A home-garden series and a canning-drying series were distributed in much the same manner.

The Weekly News Letter, enlarged from 8 pages to 16 pages on occasions, has a circulation of 130,000. It reaches newspapers and other publications, Federal and State agricultural workers and cooperators, agricultural leaders, libraries, and chambers of commerce. As the official organ of the Department, it carries material intended to further national agricultural campaigns and publishes official statements. Popular articles discussing the experimental results of and advice on agricultural methods also are used in more detail than in other departmental news channels.

Through its mimeographed news service, the Department furnishes daily, or as the necessity for prompt distribution demands, timely information regarding its activities to press associations, correspondents, newspapers, agricultural jour-

nals, and specialized publications generally or locally. By reason of its increased activities, the amount of material supplied through this channel in the last year has been approximately doubled.

Conferences were held with agricultural editors to determine how the Department could better aid them, to acquaint them with its production programs and purposes, and to obtain their suggestions and enlist their cooperation. The needs of the farm press also were ascertained in an extensive questionnaire in which editors were invited to indicate their requirements in detail and to give other information useful to the Department in further developing its agricultural press service. During the year a reclassification of mailing lists was completed. The lists as now established provide for more intelligent distribution of material generally and locally and make it easier to avoid unnecessary duplication and waste.

EXHIBITS.

At present the Department of Agriculture is the only executive department maintaining an Office of Exhibits. Its purpose is to centralize the administration of the exposition services of the Department and to secure uniformity of practice in designing and displaying its educational exhibits. During the past year this work developed along lines connected with the stimulation of food production and conservation. The demands for exhibits from fair associations and similar organizations were so great that it was impossible fully to meet them.

During the fiscal year ended June 30, 1918, the Department made, through the Office of Exhibits, over 30 exhibitions and demonstrations relating to food production, conservation, and distribution. These exhibitions covered a wide range of territory, from New England to Florida and California, and brought the work of the Department to the

direct attention of more than 3,000,000 people. At a number of these fairs the Department's exhibits occupied areas of 5,000 square feet or more, and the attendance ran from 150,000 to 950,000.

In response to a widespread popular request for war exhibits at the larger fairs, the Secretary of Agriculture, on April 5, 1918, addressed a communication to the Secretaries of War, Navy, Interior, and Commerce Departments, and to the Food Administration, and invited a conference of representatives from those Departments to work out, with officers of the Department of Agriculture, a coordinated plan of action. This resulted in the formation of a Joint Committee on Government Exhibits, composed of representatives from each of the Departments named. The expert on exhibits of this Department was made chairman of the committee. A plan was evolved and executed to send an impressive joint Government exhibit to 37 State and other fairs and expositions. It is believed that this exhibit was of the highest value in educating and stimulating the people to greater industrial activities, to larger agricultural production, and to a broader and deeper appreciation of their country and Government.

MOTION PICTURES.

The dissemination of information by means of motion pictures, which hitherto has been conducted only on an experimental basis, was, by action of Congress, given a definite allotment of funds, which enabled the Department to undertake the systematic development of this activity. Films prepared in the Department's laboratory were used very effectively in connection with its efforts to recruit farm labor, encourage the preservation of perishable fruits and vegetables, prevent forest fires, and stimulate agricultural production. They were shown, through the extension service, to approximately 500,000 people at demonstration meetings,

county and State fairs, schools, churches, and municipal gatherings, and, by arrangement with one of the commercial companies, to about 4,000,000 people at motion-picture theaters. The film companies actively cooperated with the Department and rendered valuable assistance by placing information and appeals of an emergency character before the patrons of the theaters served by them.

PURCHASE AND DISTRIBUTION OF NITRATE OF SODA.

The food control act, which authorized the President to procure and sell nitrate of soda to farmers at cost for the purpose of increasing production, appropriated \$10,000,000 for that purpose. By direction of the President, the War Industries Board made arrangements for the purchase of the nitrate and the Secretary of Agriculture for its sale and distribution. The Bureau of Markets was designated as the agency to handle the work for the Department.

Contracts were made for the purchase of about 120,000 short tons of nitrate, and arrangements were effected through the Shipping Board to secure tonnage for transporting it from Chile. A selling price of \$75.50 on board cars at port of arrival was announced in January, 1918, and farmers were given an opportunity to make applications through the county agents and committees of local business men appointed for the purpose. Applications for amounts totaling more than 120,000 tons were received from 75,000 farmers, who asked for lots ranging from one-tenth of a ton to more than 100 tons. On account of the lack of available shipping it was possible to bring in, up to June 30, 1918, only about 75,000 tons, practically all of which actually was sent to farmers by that date.

Some of the nitrate was shipped direct to farmers, but the greater part was consigned to county distributors in the counties requiring large quantities. These distributors were appointed when it became evident early in the year that, on

account of the lack of vessels, sufficient nitrate would not arrive in time to make complete delivery during the period of greatest need. Through them it was possible to make quick and equitable distribution and to save farmers the interest on deposits required for payments, since shipments for the county were made to the distributors on sight draft with bill of lading attached and distribution was made by them to the farmers. On June 30, there remained in Chile between 39,000 and 40,000 short tons of nitrate for which the Department had been unable to secure transportation to this country from the Shipping Board.

HIGHWAY CONSTRUCTION.

Considerably in advance of the highway construction season of 1918 steps were taken to conserve money, labor, transportation, and materials in highway work and at the same time to facilitate the progress of really essential highway projects.

In connection with the Federal aid road work, a letter was addressed to each State highway department asking that a program of Federal aid construction be submitted at the earliest possible date, in which would be included only those projects which the State highway departments considered vitally necessary to the transportation facilities of the country. Such programs were submitted by all of the States, and evidence of the thoroughness with which highway projects were considered is disclosed in the statement that, while \$14,550,000 were available for expenditure on post roads from the passage of the act, only \$425,445 were paid from Federal funds on all projects. Projects, however, were approved for each State involving sufficient amounts to protect the States in their apportionments.

At the same time a cooperative arrangement was effected, at the request of the Capital Issues Committee, under which engineers of the Department were made available for in-

specting and reporting upon proposed highway, irrigation, and drainage bond issues. This work assumed considerable proportions almost immediately. Inspections were made of 126 highway projects, involving bond issues to the amount of \$49,276,366; irrigation projects to the number of 25, involving \$18,279,060; and drainage bonds to the number of 30, involving \$19,356,970, or total bond issues of \$86,912,396.

In view of the enormous amount of bituminous materials, comprising oils, asphalts, and tars, used in highway work, and particularly in highway maintenance, it became early in the season a matter of much concern as to what effect the conservation of fuel oils and tars would have upon the vitally important problem of highway maintenance. Accordingly, the matter was taken up with the Fuel Administration and an arrangement perfected whereby the highways of essential importance should receive enough bituminous material to provide for adequate maintenance and, where necessary, to permit construction and reconstruction. The cooperation became actively effective on May 13, 1918. From that time until the close of the fiscal year 2,235 applications, calling for 75,000,000 gallons of bituminous material, were received from States, counties, and municipalities, and of this amount approval was given and permits issued for 58,000,000 gallons. A short time before the close of the fiscal year, however, this cooperation was merged into the larger activities of the United States Highways Council.

UNITED STATES HIGHWAYS COUNCIL.

In order to coordinate the activities of various Government agencies so far as they relate to highways; to better conserve materials, transportation, money, and labor; to eliminate delays and uncertainties; and to provide positive assistance in carrying on vitally essential highway work, I requested each of the Government departments and administrations interested to name a representative to serve on a

council to deal with highway projects during the period of the war. As a result, the United States Highways Council, consisting of a representative from the Department of Agriculture, the War Department, the Railroad Administration, the War Industries Board, and the Fuel Administration, was formed in June. During the first four months of its existence, the council passed upon about 5,000 applications, involving nearly 4,000,000 barrels of cement, 3,250,000 tons of stone, 1,140,000 tons of gravel, 1,207,000 tons of sand, over 77,000,000 brick, and nearly 20,000,000 pounds of steel, and 140,000,000 gallons of bituminous materials.

FOREST FIRES.

Protection of the forests against disastrous fires proved an exceptionally difficult task. An unusual strain was imposed on an organization somewhat depleted in numbers and much weakened by the loss of many of its most experienced men. Added to this was the difficulty of securing good men for temporary appointment as guards during the fire season and bodies of men for fighting large fires. An unusually early and severe dry season caused the outbreak of serious fires before the summer protective organization was fully ready for them. Some embarrassment in meeting the situation was caused by the failure of the annual appropriation act to pass Congress until after the fire season was virtually over. Ordinarily, expenditures during the summer months are greater than those for the remainder of the fiscal year. Therefore, the sums available under the continuing appropriation of one-sixth of the annual appropriation for the preceding year to cover the months of July and August were insufficient to meet the situation. Relief was furnished by the President, who placed \$1,000,000 at my disposal as a loan from his emergency fund. It may be necessary to seek from Congress again a deficiency appropriation of \$750,000.

The greater part of the extra outlay for fire fighting was on a relatively small number of forests in the Northwest which present conditions of great difficulty. These forests for the most part are rugged, unbroken wilderness. While the Forest Service for years has been attempting to develop a system of communications in the form of trails, telephone lines, and roads to facilitate the early discovery of fires and quick action to extinguish them, the funds available for construction work have been too limited to permit of rapid progress. There is no resident population at hand to draw upon for fire fighters, so that when large fires develop forces must be organized in towns and cities scores if not hundreds of miles away, transported by railroad to the points nearest the fire, sent long distances into the woods, and there provided with equipment and food by pack trains. The inevitable result of such conditions is that fires which in other regions would be quickly put out, gain headway, burning, perhaps, for several days before the effort to bring them under control can begin. There should be provision for pushing more rapidly the improvement work on these forests, for a greater number of forest guards, and for the earlier organization of the protective system each fire season. For these purposes, the estimates submitted to Congress include increases for specific forests totaling \$230,808.

WATER POWER.

In my report of last year I emphasized the need of water-power legislation and, since three departments would be directly involved, suggested that it contain a provision for an administrative commission composed of the Secretaries of War, the Interior, and Agriculture. After prolonged consideration by a special water-power committee, a measure was drafted and was passed by the House of Representatives. Its early enactment into law would remove many uncertainties in the water-power situation and would directly conduce to the public interest.

RECENT LEGISLATION AND DEVELOPMENT.

The last five years have been especially fruitful of legislation and of its practical application for the betterment of agriculture. Special provision was made for the solution of problems in behalf of agriculture, embracing marketing and rural finance. The Bureau of Markets, unique of its kind and excelling in range of activities and in financial support any other similar existing organization, was created and is rendering effective service in a great number of directions. Standards for staple agricultural products were provided for and have been announced and applied under the terms of the cotton futures and grain standards acts. Authority to license bonded warehouses which handle certain agricultural products was given to the Department, and the indications are that, with the return of normal conditions the operation of the act will result in the better storing of farm products, the stabilization of marketing processes, and the issuance of more easily negotiable warehouse receipts. The agricultural extension machinery, the greatest educational system ever devised for men and women engaged in their daily tasks, had very large and striking development. The Federal aid road act, approved shortly before this country entered the war, resulted in legislation for more satisfactory central highway agencies in many States and the systematic planning of road systems throughout the Union. To-day each State has a highway authority, with the requisite power and with adequate funds to meet the requirements of the Federal measure. The Federal reserve act, which has benefited every citizen through its influence on banking throughout the Union, included provisions especially designed to assist the farming population. It authorized national banks to lend money on farm mortgages and recognized the peculiar needs of the farmer by giving his paper a maturity period of six months. This was followed by the Federal farm loan act, which created a banking system reaching intimately into the rural

districts and operating on terms suited to the farm owners' needs. This system began operations under the troubled conditions of the world war, and its activities were impeded by the vast changes incident to the entry of this country into the conflict. But, in spite of these difficulties, it has made remarkable headway, and there is little doubt that, after the return of peace, its development will be rapid and will more than fill the expectations of the people.

FURTHER STEPS.

PERSONAL CREDITS.

It still seems clear that there should be provided a system of personal-credit unions, especially for the benefit of individuals whose financial circumstances and scale of operations make it difficult for them to secure accommodations through the ordinary channels. Organized commercial banks make short-term loans of a great aggregate volume to the farmers of the Nation possessing the requisite individual credit, but there are many farmers who, because of their circumstances, are prevented from securing the accommodations they need. An investigation by the department to determine the extent to which farmers in the Southern States were dependent upon credit obtained from merchants revealed the fact that 60 per cent of them were operating under the "advancing system." The men I have especially in mind are those whose operations are on a small scale and who are not in most cases intimately in touch with banking machinery, who know too little about financial operations, and whose cases usually do not receive the affirmative attention and sympathy of the banker. Such farmers would be much benefited by membership in cooperative credit associations or unions.

Of course, there are still other farmers whose standards of living and productive ability are low, who usually cultivate the less satisfactory lands, who might not be received for the present into such associations. This class peculiarly

excites interest and sympathy, but it is difficult to see how any concrete financial arrangement will reach it immediately. The great things that can be done for this element of our farming population are the things that agricultural agencies are doing for all classes but must do it with peculiar zeal. The approach to the solution of its difficulty is an educational one, involving better farming, marketing, schools, health arrangements, and more sympathetic aid from the merchant and the banker. If the business men of the towns and cities primarily dependent on the rural districts realize that the salvation of their communities depends on the development of the back country and will give their organizing ability to the solution of the problem in support of the plans of the organized agricultural agencies responsible for leadership, much headway will be made.

The foundation for effective work in this direction is the successful promotion of cooperative associations among farmers, not only for better finance but also for better production, distribution, and higher living conditions. These activities are of primary importance. At the same time, it is recognized that such cooperation can not be forced upon a community, but must be a growth resulting from the volunteer, intelligent effort of the farmers themselves.

The Department has steadily labored especially to promote this movement by conducting educational and demonstrational work. Field agents in marketing have been placed in most of the States to give it special attention, and the county agents and other extension workers have rendered, and will continue to render, valuable assistance. The operations of the Farm Loan Board, especially in promoting the creation of its farm-loan associations, should be influential and highly beneficial.

What further can be done by the Federal Government directly to stimulate personal-credit unions it is difficult to outline. This matter has received consideration at the hands

of many experts and was thoroughly canvassed by a joint committee of Congress. The conclusion, up to the present, seems to be that the field is one primarily for the States to occupy through sound legislation. During the last five years State laws, more or less adapted to the purpose, have been enacted in Massachusetts, New York, Rhode Island, Wisconsin, Texas, North Carolina, South Carolina, Utah, and Oregon. Under these about 125 associations have been organized, but the larger percentage of them have been formed by wage earners in urban centers. The attempt to develop strictly rural credit bodies has met with somewhat more success in North Carolina than elsewhere. In this State the work of promoting and supervising such organizations was placed in charge of an official in the Division of Markets and Rural Organization of the State College of Agriculture. The law of this State was enacted in 1915, and at present 18 credit unions, all of them rural, are in operation. It is noteworthy that the North Carolina law makes special provision for educational and demonstrational activities.

In 1917 the Bureau of Markets prepared a tentative form of a model State personal credits law. This was published in its Service and Regulatory Announcements. In it were embodied the best views on the subject, but it was submitted merely as a tentative plan.

The Department, with its existing forces and available funds, will continue to foster the cooperative movement and to keep in close touch with the Federal Farm Loan Board.

LAND SETTLEMENT.

Interest in land for homes and farms increases in the Nation as the population grows. It has become more marked as the area of public land suitable and available for agriculture has diminished. It is intensified at the present time by reason of the suggestion and desire that returned soldiers and others who may wish to secure farms shall have an op-

portunity to do so under suitable conditions. It finds expression, too, in discussions of the number of tenant farmers and in its meaning and significance.

That there is still room in the Nation for many more people on farms is clear. The United States proper contains about 1,900,000,000 acres of land, of which an area of 1,140,000,000 acres, or 60 per cent, is tillable. Approximately 367,000,000 acres, or 32 per cent, of this was planted in crops in 1918. In other words, for every 100 acres now tilled 300 acres may be utilized when the country is fully settled. Of course, much of the best land, especially that most easily brought under cultivation and in reasonably easy reach of large consuming centers, is in use, though much of it, possibly 85 per cent, is not yielding full returns. Extension of the farmed area will consequently be made with greater expense for clearing, preparation, drainage, and irrigation, and for profitable operation will involve marketing arrangements of a high degree of perfection and the discriminating selection of crops having a relatively high unit value.

Increased production can therefore be secured in two ways, namely, through the use of more land and through the adoption of improved processes of cultivation of all land and of marketing. The latter involves the general application of the best methods used by the most skillful farmers and urged by experienced, practical, and scientific experts. It will necessitate seed selection and improvement, plant and animal breeding, soil development through rotation, the discriminating use of fertilizers, the control and eradication of plant and animal diseases, good business practice and thrift, and many other things. It means that farming must be profitable and that society must be willing to pay the price. Under no other condition can farming expand. It means, too, that only as many will or need stay on farms as may be necessary to supply what the consumers will take at prices which will justify production. Many

people speak as if they thought there should be no limit to the number engaged in agriculture or to production of crops. The farmer must consider his balance just as much as any other business man. The number of individuals remaining in the farming industry will, in the long run, continue to adjust itself roughly to the economic demand and will increase as it expands or as relative economies are effected.

To a certain extent, we are still pioneering the continent, agriculturally and otherwise, and are still exporters of food, feedstuffs, and materials for clothing. With wise foresight and increased employment of scientific practice, under the stimulation of intelligent agencies, we can take care of and provide for a very much larger population under even more favorable circumstances and in greater prosperity. This is the task to which the Nation has set itself and indicates the responsibility resting upon each individual, and especially upon the farming population and State and Federal agencies responsible for leadership. We have, up to the present, succeeded in this enterprise. In the years from 1900 to 1915 the Nation gained a population of approximately 22,000,000, and they have been fed and clothed in large measure from domestic sources. It is estimated that in the years from 1915 to 1918 the population increased by 3,200,000, of which a very small part was from immigration. We shall, perhaps, gain as many more in the next 15 or 20 years, even if the rate of immigration should not be maintained, for the natural growth in recent years, averaging about three-fourths of a million a year, shows an upward tendency.

It would be desirable to facilitate land settlement in more orderly fashion. This can be effected in a measure by systematic effort on the part of the Federal Government, the States, and the several communities through appropriate agencies to furnish more reliable information, intelligent guidance, and well-considered settlement plans. The Nation has suffered not a little from irresponsible and haphazard

private direction of settlement. In many sections, especially in the newer and more rapidly developing ones, the situation has been complicated by the activities of promoters whose main concern was to dispose of their properties. They too frequently succeeded in attracting farmers to localities remote from markets where they either failed to produce crops or met with disaster through lack of market outlets or adequate marketing arrangements.

It is particularly vital that, by every feasible means, the processes of acquiring ownership of farms be encouraged and hastened. This process is real in spite of appearances to the contrary. It has been too generally assumed and represented that tenancy has increased at the expense of ownership and that we are witnessing agricultural deterioration in this direction. Tenancy does present aspects which should cause great concern, but its bright sides have not been sufficiently considered. The situation does not warrant a pessimistic conclusion. In the 30 years from 1880 to 1910 the number of farms in the United States increased from 4,009,000 to 6,362,000, the number of those owned from 2,984,000 to 4,007,000, a gain of 1,023,000, or 34.3 per cent, and the number operated by tenants from 1,025,000 to 2,355,000, a gain of 1,330,000, or 129.9 per cent. But in 1910, five-eighths of the farms and 68 per cent of the acreage of all land in farms were operated by owners and 65 per cent of the improved land. The number of farms increased faster than the agricultural population. The only class not operating farms who could take them up were the younger men, and it is largely from them that the class of tenants has been recruited.

In a recent study of the cases of 9,000 farmers, mainly in the Middle Western States lying in the Mississippi Valley, it was found that more than 90 per cent were brought up on farms; that 31½ per cent remained on their fathers' farms until they became owners and 27 per cent until they became tenants, then owners; that 13½ per cent passed from wage

earners to ownership, skipping the tenant stage; and that 18 per cent were first farm boys, then wage earners, later tenants, and finally owners. It is stated, on the basis of census statistics, that 76 per cent of the farmers under 25 years of age are tenants, while the percentage falls with age, so that among those 55 years old and above only 20 per cent are tenants. In the older sections of the country (except in the South, which has a large negro population), that is, in the New England and Middle Atlantic States, the tenant farmers formed a smaller proportion in 1910 than in 1900. This is also the case with the Rocky Mountain and Pacific Divisions, where there has been a relative abundance of lands. The conditions on the whole, therefore, are not in the direction of deterioration but of improvement. The process has been one of emergence of wage laborers and sons of farmers first to tenancy and then to ownership.

The legislative steps that have been taken to promote better credit terms for farmers will have a tendency to hasten this process. The operation of the farm-loan system, through arrangements by which those who have sold lands take a second mortgage subordinate to the first mortgage of the farm-land banks, carrying a relatively low rate of interest, will have a beneficial influence. If further developments can be made through the application of the principle of cooperation, especially in the formation of personal-credit unions, the conditions will be more favorable. In the meantime special attention and study should be given to the terms of tenancy, including the lease contract, with a view to increase the interest both of the landlord and of the tenant in soil improvement and to make sure that there is an equitable division of the income.

FURTHER HIGHWAY DEVELOPMENT.

Cooperative construction road work under the Federal aid act will be resumed in full measure and be vigorously prosecuted at the earliest possible moment. At the close of the

fiscal year approximately \$14,000,000 covered by project agreements were still available for expenditures from Federal and State funds, and immediately thereafter the Federal appropriation of \$15,000,000 for the fiscal year 1919 also became available. Project statements not yet reaching the stage of agreements, involving \$28,000,000 from all sources, have been approved, making an aggregate, for projects either definitely or tentatively agreed upon, of \$42,000,000. The part of this sum from Federal funds is approximately \$16,000,000, leaving uncovered approximately \$14,000,000. If the State contributions for cooperative work continue in the same proportion, there will become available from them approximately \$20,000,000, or a total uncovered, Federal and State, of \$34,000,000. It seems clear, therefore, that if the work proceeds without any undue restriction, its volume will be represented by the cooperative expenditure of over \$70,000,000 during this fiscal year. For the fiscal year 1920 there will be available \$20,000,000 of Federal funds, which will doubtless be met by a larger contribution from State sources.

The activities should promptly be resumed because good roads are essential not only for the promotion of better marketing, the fuller utilization of farm labor, larger and more economical production and orderly distribution, but also for the development of a richer and more attractive rural life. Their importance to urban communities and to industry and trade in general is obvious, but there is also a consideration of an emergency nature which would prompt vigorous action. In the transition from war to peace there will doubtless be a period in which some laborers engaged in war industries and men released from the Army will be seeking new tasks and, so far as governmental intervention is concerned, the tasks on which they may be employed should be of the highest public utility.

Public works would furnish suitable employment for many unemployed men, and among such enterprises there are few

kinds whose construction is better worth expanding and pressing than public roads. Many of the States will probably engage in road building as in normal times from funds which they may have available in addition to those pledged to meet requirements of the Federal law. Cities also will resume operations in this field, but, in view of the transitional difficulties, we should not depend solely on activity under existing law and financial provisions. An additional appropriation from the Federal Treasury, to be expended through this Department, for highway construction would seem to be desirable and fully warranted, and such action is suggested for urgent and serious consideration. If ample funds are made available to the Department, they should be expended on projects selected after consultation with the Federal Departments interested, especially War, Commerce, and Post Office, as well as with the State central highway authorities.

STOCKYARDS AND PACKING HOUSES.

Under the authority conferred upon the President by the food-control act, substantial progress was made by the Department of Agriculture in the regulation and supervision of stockyards and of commission men, traders, order buyers, packers, and others handling or dealing in live stock in or in connection with stockyards. The important results already accomplished in the improvement of live-stock marketing conditions, and in the elimination of many uneconomic and unfair market practices, demonstrate the effectiveness of the form of control which has been exercised under the war power and the desirability of continuing it or a similar form of supervision. Not only the stockmen who patronize these great centers of live-stock trade, but also some members of the trade themselves, have recognized the possibilities for betterment of marketing conditions through their regulation by the Department, utilizing its corps of supervisors clothed

with the requisite authority. Besides the protection thus extended to consignors of live stock for sale at the markets, the opportunity is afforded for improvement in methods, facilities, and trade practices incident to the handling and sale of live stock involving many millions of dollars daily.

Closely associated with the supervision of live-stock markets is the problem of a similar authority over the slaughtering, meat-packing, and related interests which are centered at the principal live-stock markets. Under the regulations applied to meat-packing establishments by the Food Administration, limitations have been placed on profits on meats and by-products handled by these establishments, the installation of uniform accounting systems has progressed with comparative rapidity, and the centralization of control by a small group of packers has been materially checked. The economic welfare of meat production and distribution would be promoted by the continuation and development in some form of the supervision over the packing industry. Such control should be closely coordinated with that over the live-stock markets. There is need, in connection with this supervisory system, of a central office to which packing concerns should be required to report currently in such form and detail that it would be constantly informed concerning their operations. Such an arrangement would afford protection to producers and consumers.

The restoration and maintenance of conditions which will justify confidence in the live-stock markets and meat-packing industry is the greatest single need in the present meat situation in the United States. It seems desirable, therefore, that the necessary legislation be enacted at the earliest possible moment. The assurance of open competition and the stabilizing of prices in the live-stock markets, the elimination of evil practices, the adjustment of charges for market services, and the restoration of confidence in market conditions generally, apparently require three remedies, namely,

regulation, information, and voluntary cooperation. Federal regulation, organized and administered as indicated above, exercised in close harmony with the regulatory bodies of the various States, is the most essential feature. Constant publicity, under Government direction, of current market prices, supplies, movements, and other conditions pertaining to the marketing of live stock, meats, and animal by-products, would add immeasurably to the effectiveness of any form of regulation. It would also be a means of stabilizing the marketing of live stock and its products and of making available the information required by producers and distributors for the most intelligent and economical marketing of their products. Progress already has been made in the creation of machinery for such service at market centers in all parts of the United States. Legislative authority for its further development in connection with live-stock market supervision should be continued and extended. Finally, better organization of live-stock producers and closer cooperation between their organizations and those representing the different classes of intermediaries, all working in harmony with agencies of the Government directly concerned, will also increase the effectiveness of regulation and publicity, make for the maximum of efficiency, and conduce to the welfare of the packers and distributors as well as of the producers and consumers.

FEDERAL FEED AND FERTILIZER LAW.

At present, in order to secure for the public the benefits of the provisions of the Federal food and drugs act with reference to animal feeds, it is necessary to rely on the appropriate statutes of the different States. These are not uniform, and there are a few States which have no laws that can be invoked. It is believed that it would be wise to have a comprehensive Federal feed law placed upon the statute books, under which the Government could proceed in a uniform manner and secure to consumers adequate protection

against misbranded, adulterated, and worthless feeds entering into interstate commerce. It is probable also that similar legislation would be feasible and valuable with reference to fertilizers passing into interstate commerce. It is obvious, of course, that if such laws could be enacted they should result in the protection not only of the consumer but also of the honest manufacturer and distributor.

I am convinced that there is much indiscriminate use of commercial fertilizers in this country and, therefore, much waste of money. This arises from the lack of available satisfactory data. Soils require careful treatment just as does the human body. A number of States have conducted fertilizer experiments over a long period and have obtained and disseminated valuable information. Because of the importance of this matter for the whole Union, I believe that the Federal Government should participate in this work and that an adequate sum should be made available to the Department for cooperative experiments with State institutions.

EMERGENCY PRODUCTION WORK.

As has been indicated, during the last year and a half, under the food-production measure, the activities of the Department have been greatly expanded in a number of directions. Especially striking has been the development of the extension forces, including the county agents, the control and eradication of animal diseases, and the Market News Services. Many trained men and women have been engaged in these tasks. It is highly desirable that provision should continue for these and other emergency undertakings during the remainder of this fiscal year. Indications from every part of the Union are that the efforts of the agricultural colleges and the Department in emergency directions have been fruitful and are appreciated by the great masses of the farmers.

The question arises also whether it would not be in the national interest to make provision for the continuance of a part of the work, at least, after the end of this fiscal year. The work of the Bureau of Markets, especially through its news services, has been demonstrated to be so useful that, regarding it as of permanent value, I have transferred the emergency estimates for it, in part, to the regular bill. The Nation is now engaged, under the act of May 8, 1914, in developing the agricultural extension service. It would be wise to anticipate the amount that would accrue under this measure by the end of the period 1922 and to make such further provision as may be necessary for the continuance of agents of proved efficiency already on the rolls, as well as to continue the intensive work for the more speedy control and eradication of tuberculosis, hog cholera, and the cattle tick, and other important lines of effort. Expenditures for these activities are investments, and it is simply a question how rapidly the Nation wishes the work to proceed. If the finances of the Nation permit it, I urgently recommend that adequate provision be continued.

RURAL HEALTH AND SANITATION.

Every means should be adopted to see to it that the benefits of modern medicine accrue more largely to the scattered populations of the rural districts. Formerly the urban communities were characteristically the homes of disease. They possessed all the disadvantages of concentration of population without adequate sanitary safeguards. Now no cities and very few of the larger towns are without substantial equipment in the way of drainage, sewage disposal, and hospitals. They have the services of specialists and of trained nurses. Very many of them provide free medical and dental clinics for people of limited means, have their schools inspected, and their water and milk supplies regularly tested and safeguarded. As a consequence, among the inhabitants

of the larger communities the ravages of smallpox, typhoid fever, and malaria have been in large measure controlled. The rural districts still have advantages; but a vast deal remains to be done to control such pests as mosquitoes and the hookworm, to eliminate the sources of typhoid fever, and, even more, to give the country districts the advantages of modern hospitals, nursing, and specialized medical practice.

The economic wastes from insanitary health surroundings and from disease are enormous. It is impossible to estimate their extent. It is even more impossible to assess the amount of existing preventable human misery and unhappiness. The remedy is difficult. Many agencies, some of them private enterprises with large funds, are working for improvement. States and medical societies here and there are contributing, more or less effectively. The extension and improvement of agriculture, including the drainage of lands, the clearing of swamps, and the construction of good roads, make for betterment. The Department of Agriculture, through its home-demonstration service, is giving valuable aid, and the Public Health Service is increasingly extending its functions, especially recently under an appropriation for this purpose of \$150,000. To what extent the further projection of effort is a matter for State or local action remains to be determined, but it seems clear that there should be no cessation of activity until there has been completed in every rural community of the Union an effective sanitary survey and, through the provision of adequate machinery, steps taken to control and eliminate the sources of disease and to provide the necessary modern medical and dental facilities, easily accessible to the mass of the people.

Respectfully,

D. F. HOUSTON,
Secretary of Agriculture.

THE PRESIDENT.



THE BLACK STEM RUST AND THE BARBERRY.

By E. C. STAKMAN,

Pathologist in Charge of the Barberry Eradication Campaign, Office of Cereal Investigations, Bureau of Plant Industry.

THE BLACK STEM RUST of wheat, oats, barley, rye, and about 50 cultivated and wild grasses is one of the most destructive diseases of these plants. There are several distinct kinds of rust, but the black stem rust causes greater total losses than any of the others, although in some sections one or more of the other rusts may be more important. This paper deals only with the black stem rust (*Puccinia graminis*).

DAMAGE DONE BY BLACK STEM RUST.

The black stem rust is found practically wherever grain is grown in the United States. It is also found generally in Canada, South America, Europe, Asia, Africa, and Australia. In many sections of the United States black stem rust is the limiting factor in grain production. While it is especially destructive to wheat, it does a great deal of damage also to oats, barley, and rye. It is most serious on spring wheat, but sometimes it also may cause enormous losses of winter wheat. In the Gulf States it is sometimes so serious as to make it entirely unprofitable to grow wheat and other small grains.

At irregular intervals rust develops ravaging epidemics which sweep across great areas of the grain-growing regions and almost completely destroy immense quantities of grain. Some rust epidemics have been so serious and widespread as to cause a decided shortage of foodstuffs. It is necessary only to recall the terrible epidemics of 1904 and 1916. It was estimated that in 1904 the rust caused a loss of \$20,000,000 in Minnesota and the two Dakotas. In 1916 the production of wheat in Minnesota, North Dakota, South Dakota, and Montana was reduced by over 200,000,000 bushels from that of the previous year. This appalling loss was caused very largely by the black stem rust. After making

due allowance for the reduction in acreage in some of these States and after making allowance for somewhat unfavorable weather, the fact remains that the principal cause of this enormous loss was the black stem rust. Thousands of acres of wheat never were cut. The grain would not have paid for harvesting and thrashing. Hundreds of farmers in the spring-wheat region were practically ruined on account of the almost complete failure of the wheat crop. In addition to the enormous reduction in yield, the quality of the wheat produced was very inferior. Much of it weighed only 40 to 50 pounds to the bushel. (See Pls. I and II.)

In 1916 the average yield of spring wheat in North Dakota was only $5\frac{1}{2}$ bushels per acre, compared with an average yield of more than 18 bushels in 1915 and a 10-year average of more than 11 bushels an acre. In South Dakota the average yield in 1916 was not quite 7 bushels per acre, as compared with 17 bushels in 1915 and a 10-year average of $10\frac{1}{2}$ bushels. The greatest reduction in total production occurred in North Dakota. The production in that State in 1915 was about 150,000,000 bushels, while in the severe rust year of 1916 it was less than 40,000,000 bushels. The production in Minnesota in 1915 was about 70,000,000 bushels, but it dropped to 28,000,000 bushels in 1916. The most conservative estimate places the loss of wheat in the United States due to the black stem rust in 1916 at 180,000,000 bushels, while the loss in Canada was estimated at about 100,000,000 bushels. In Canada and the United States, therefore, the black stem rust destroyed at least 280,000,000 bushels of wheat in a single year. To this must be added the loss of oats, barley, and rye. Reports showed very clearly that the loss of barley and oats in some localities often amounted to as much as 15 to 25 per cent of the crop.

Any plant disease which causes such enormous losses certainly deserves careful study. Whatever measures are known for reducing rust losses should be applied immediately. Not only farmers, grain dealers, and millers are interested in the grain crop, but every one in the country is interested, either directly or indirectly.

In order to apply control measures, it is necessary to know something about the nature of the disease. A brief life story of the parasite causing the black stem rust therefore is given.

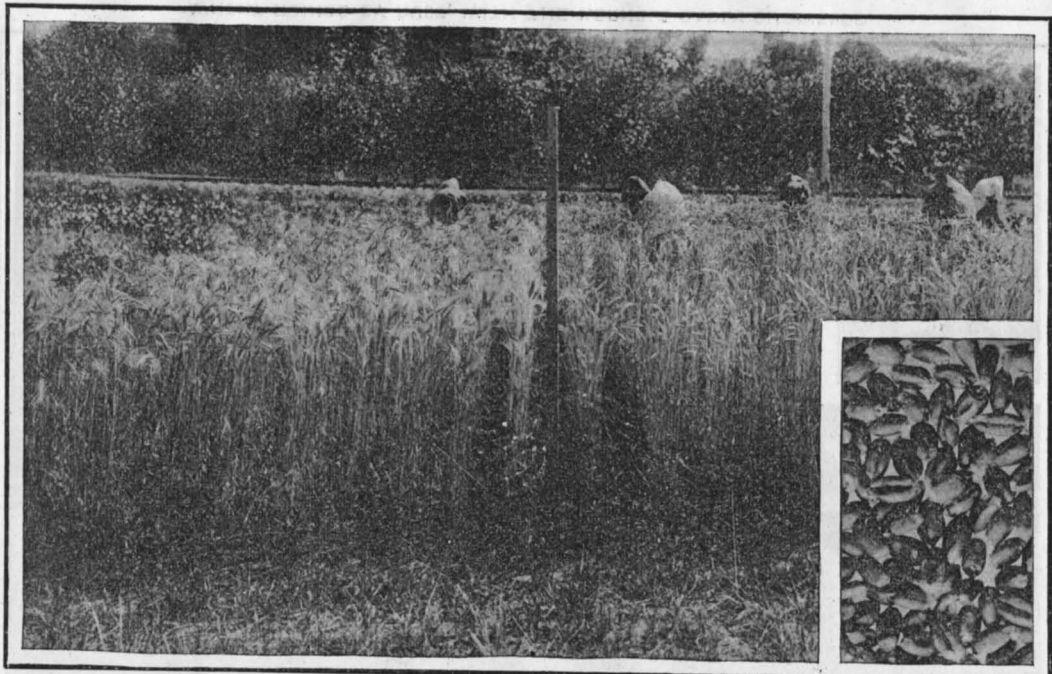

A GOOD STAND OF WHEAT, NOT RUSTED, WHICH PRODUCED THESE SOUND, PLUMP KERNELS.



WHEAT RUINED BY RUST, WITH THE KERNELS BADLY SHRIVELED.

HOW TO TELL BLACK STEM RUST.

Black stem rust is often confused with other rusts of grain which are similar in appearance but act differently. The common rusts are the black stem rust, the yellow stripe rust, the orange leaf rust of wheat, the crown rust of oats, the brown leaf rust of rye, and the dwarf leaf rust of barley. Each of these rusts has a red or summer stage and a black or winter stage. They can be distinguished from each other by the shape and color of the rust spots (pustules) and by their position on the plant. Plate III shows the different kinds of rust.

The black stem rust (*Puccinia graminis*) occurs on wheat, oats, barley, rye, and many grasses throughout the United States. (See Pl. III, fig. 1.) It also develops on the common barberry. It is the only one of the grain rusts which develops on this shrub. The yellow stripe rust (*Puccinia glumarum*) occurs on wheat, barley, rye, and several wild grasses. (See Pl. III, fig. 2.) It seems to be confined to the West and is especially common west of the Rocky Mountains, where it sometimes becomes quite destructive. The orange leaf rust (*Puccinia triticina*) is found on wheat and possibly also on several grasses. (See Pl. III, fig. 3.) It occurs practically wherever wheat is grown in the United States and is capable of doing much damage, especially in the Southern States. Crown rust of oats (*Puccinia coronifera*) attacks oats and several grasses. (See Pl. III, fig. 4.) It is often serious on oats in certain sections of the country. The brown rust of rye (*Puccinia dispersa*) attacks rye and possibly a few grasses (see Pl. III, fig. 5), while the dwarf leaf rust of barley (*Puccinia simplex*) seems to be confined almost entirely to barley and seldom does much damage, except possibly in California. (See Pl. III, fig. 6.)

Each kind of grain may be attacked by several distinct rusts. For instance, wheat may be attacked by the black stem rust, the yellow stripe rust, and the orange leaf rust. These rusts are different and should not be confused with each other. Barley can be attacked by the black stem rust, the yellow stripe rust, and the dwarf leaf rust; rye by the black stem rust, the yellow stripe rust, and the brown leaf rust; and oats by the black stem rust and the crown rust.

These rusts differ from each other so much that what is said about one does not necessarily apply to the others.

GRAINS AND GRASSES ATTACKED BY BLACK STEM RUST.

Wheat, oats, barley, rye, spelt, emmer, einkorn, timothy, redtop (*Agrostis alba*), orchard grass (*Dactylis glomerata*), and various other forage grasses are attacked by the black stem rust. In addition to the cereals and cultivated grasses many wild grasses also are subject to rust. Among the most important of these grasses are wild barley or squirrel-tail grass (*Hordeum jubatum*), quack-grass (*Agropyron repens*), slender wheat-grass (*Agropyron smithii*), awned wheat-grass (*Agropyron caninum*), bottle brush-grass (*Hystrix patula*); practically all of the wild rye-grasses (*Elymus* spp.), fescue grasses (*Festuca* spp.), koeleria (*Koeleria cristata*), sweet vernal grass (*Anthoxanthum puelli*), and several brome-grasses (*Bromus* spp.). (See Pl. IX, fig. 2.)

Although all of these plants can be attacked by the black stem rust, there are forms or races of this rust which act somewhat differently. For instance, there is one race of black stem rust on wheat and barley. This race does not attack oats or rye normally. There is also a race on rye and barley which does not attack wheat and oats. Again, the race on oats attacks only oats and certain grasses. The race on timothy attacks only timothy and several wild grasses. All of the races can attack several of the wild grasses, but not all of them can attack the same grasses. This explains apparently conflicting observations. For instance, it is quite possible that a field of oats might be badly rusted while a near-by wheat field might be almost entirely free. In the same way, a wheat field might be badly rusted and a neighboring field of rye might be practically free from rust, because the forms of rust on these different crops are different.

THE CAUSE OF RUST.

Black stem rust is caused by a parasitic fungous plant. Animal parasites are better known to most people than plant parasites. Everyone knows that tiny animals, such as lice, ticks, fleas, mites, and maggots, live as parasites on horses, cattle, sheep, swine, chickens, and other animals. These mi-

nute animal parasites cause such diseases as itch, scab, mange, staggers, and warbles.

In the same way there are uncounted numbers of tiny plants which live as parasites on or in larger plants. There is scarcely a plant of the garden or field, of the prairie or woodland, which is not subject to attack by one or more of these plant parasites. Plant parasites do not make their own food, as most plants do, but they grow on or in other plants and steal their food. The plant which is being robbed is called the host plant, although its parasitic visitor is destructive to it. Plant parasites are mostly fungi or bacteria and cause such plant diseases as rusts, smuts, mildews, leaf spots, fruit molds, rots, and wilts.

The black stem rust is caused by one of these tiny plant parasites, which is known as *Puccinia graminis*. The fungus which causes black stem rust is a small colorless moldlike plant. The other rusts shown in Plate III are caused by closely related fungous parasites, which differ from each other just as different kinds of roses or apples or wheat differ from each other.

The parasitic plant which causes black stem rust is so small that it can be seen only with a microscope. It differs from the larger plants which we know in not having definite roots, stems, and leaves. The rust parasite consists of numerous minute colorless threads or tubes, which grow, branch, and twist among the tissues of grain and grass plants. The threads send little suckers into the cells of the host plant and thus get their food by absorbing its juices. The growth of the rust parasite continues until a dense network of threads is formed, and then seed is produced in the host plant. The seeds of the parasite are known as spores. Immense numbers of spores are formed. They are extremely small, but they produce rust plants just as the seeds of wheat produce wheat plants.

The rusts get their name because they produce yellowish, reddish, or brownish spores which may be so numerous that they make the plants look as if they were covered with the well-known iron rust. The black stem rust gets its name because the long spots (pustules) of black spores on the stems of grain plants are so conspicuous. (See Pl. III, fig. 1.)

The weather, therefore, does not cause plant rusts, although there is a popular belief that it does. But the rapidity with which the parasitic plant causing rust grows and spreads depends on favorable weather, just as the growth of wheat and corn depends on favorable weather.

LIFE STORY OF THE RUST PARASITE.

There are several stages of black stem rust—the cluster-cup or early-spring stage, the red or summer stage, and the black or winter stage. (See Pl. IV.) The difference in the appearance of the rust at different times is due to the formation of different kinds of spores.

The rust starts on the barberry in the spring. Yellowish or orange-colored rust spots are formed on the leaves (Pl. IV, fig. 1), young twigs, and berries. The spots on the under side of the leaves (Pl. IV, fig. 2) consist of many small cups (cluster cups) which contain thousands of cluster-cup or spring spores (Pl. IV, fig. 3). These spores (Pl. IV, fig. 4) can not infect other barberry plants, but they are blown about by the wind and may fall on grain or grass plants and cause infection (Pl. IV, figs. 5 and 6). The red-spore or summer stage is the result.

The reddish brown rust pustules (Pl. IV, fig. 7) on grain and grasses consist of great numbers of minute, reddish or golden-colored spores (Pl. IV, fig. 8). These spores are so small and light that they are easily blown long distances by the wind. They may fall on grain or grass plants and germinate (Pl. IV, fig. 9) in the moisture formed by rain or dew on the surfaces of the plants. They often germinate within 4 or 5 hours, sending out long, slender, threadlike tubes which grow across the surface of the plant until they reach a breathing pore (Pl. IV, fig. 10). They then grow through this pore and branch in the tissues of the plant until a dense network of threads is formed. They then produce another crop of red spores (Pl. IV, fig. 11) which break through the skin (epidermis) of the plant, are exposed to the air, and are in turn blown about by the wind. They may fall on the grain or grass plants, germinate, and send their tubes into the plants, and these tubes may branch and produce more red rust pustules. Thus, new plants are continually infected and successive crops of red spores are pro-



THE SIX DIFFERENT KINDS OF GRAIN RUST, SHOWING THE DIFFERENCES IN THE SIZE, SHAPE, AND COLOR OF THE RUST SPOTS (PUSTULES) AND THE SPORES. RED OR SUMMER SPORES ABOVE; BLACK OR WINTER SPORES BELOW.

FIG. 1. Black stem rust of wheat, oats, barley, rye, and many wild grasses.

FIG. 2. Orange leaf rust of wheat.

FIG. 3. Yellow stripe rust of wheat, barley, rye, and some wild grasses.

FIG. 4. Crown rust of oats.

FIG. 5. Brown leaf rust of rye.

FIG. 6. Dwarf leaf rust of barley.



THE LIFE STORY OF BLACK STEM RUST.

- FIG. 1. Upper surface of rusted barberry leaf.
- FIG. 2. Lower surface of rusted barberry leaf, showing cluster cups.
- FIG. 3. A section through a barberry leaf, showing a single cluster cup shedding spores.
- FIG. 4. Three cluster-cup spores greatly enlarged.
- FIG. 5. Wheat leaf with several cluster-cup spores on the surface; one in a drop of water.
- FIG. 6. Cluster-cup spores germinating on wheat leaf and sending tubes through breathing pores.
- FIG. 7. One week later. The rust tubes have branched and are producing a crop of red or summer spores (the red or summer stage).
- FIG. 8. Three red spores greatly enlarged.
- FIG. 9. Red spore germinating.
- FIG. 10. Grain leaf with red spore germinating on the surface and sending a tube into the tissues of the leaf.
- FIG. 11. One week later. The tubes have produced a crop of red spores which are blown to other grain plants. This continues all summer.
- FIG. 12. When the grain begins to ripen, black spores are produced with the red spores.
- FIG. 13. Greatly enlarged pustule with red and black spores mixed.
- FIG. 14. Rust pustule enlarged still more, showing both red and black spores.
- FIG. 15. The black stage becomes abundant on grain and grass plants in the late summer.
- FIG. 16. Six black spores greatly enlarged.
- FIG. 17. The black stage on stubble in the fall. Rust overwinters in this stage.
- FIG. 18. A pustule of the black stage enlarged.
- FIG. 19. The black spores germinating in the spring. They can not infect grains or grasses, but do infect the barberry.

duced. The entire time from the germination of a spore to the production of a pustule may require only 5 or 6 days when conditions are favorable. The red stage of the rust may repeat every week or 10 days and therefore can increase and spread very rapidly. New spores may continue to develop and new plants may become rusted as long as the weather is favorable and the plants are still green.

The black-spore stage follows the red-spore stage. It is usually formed when the grain begins to ripen. The same dense network of threads which produced the red spores begins to produce the black spores, which are different from the red spores in size, color, and shape (Pl. IV, figs. 8 and 16). At first the pustules may be partly black and partly red (Pl. IV, fig. 12) because they contain both red and black spores (Pl. IV, figs. 13 and 14), but later they become entirely black. This black stage is so conspicuous that farmers usually speak of the rust as "black rust" (Pl. IV, fig. 15). The black spores (Pl. IV, fig. 16) are not blown by the wind and can not germinate immediately, but remain on the straw and stubble of grains and grasses during the winter (Pl. IV, figs. 17 and 18). The black stage can not start rust on grains or grasses, but only on the barberry.

In the spring the black spores germinate by sending out two threadlike tubes on which very small colorless spores (sporidia) are produced (Pl. IV, fig. 19). These sporidia are blown considerable distances by the wind. Strangely enough, they can not start rust on grain or grass plants, but can and do infect the common barberry. The result is the barberry rust or spring stage of black rust. Within a week or 10 days after a spore falls on a barberry leaf and causes infection, small honey-colored spots are formed on the upper surface of the barberry leaves and a great many cluster cups are formed on the lower surfaces. (See Pl. IV, fig. 2, and Pl. V, fig. 2.) The cluster cups are filled with thousands of spring or cluster-cup spores, which can not attack other barberries, but can attack grain and grasses. These spores are blown by the wind, fall on grains and grasses, germinate in a drop of dew or rain water, and each sends a tube into the tissues of grain or grass plants. These tubes grow and branch and produce a crop of the red spores within a week or 10 days.

The cycle is therefore as follows: The rust starts on the common barberry in the spring, forming the spring or cluster-cup stage. The barberry or cluster-cup stage can not spread from one barberry bush to another, but spreads to grains and grasses. The red-spore or summer stage results. The red stage continues to develop and spread as long as conditions are favorable. Late in the season the red stage is followed by the black stage. The black spores are dormant during the winter, but germinate and produce smaller spores, which in the spring attack the barberry.

It is evident, therefore, that the barberry gives the rust a chance to start in the spring and that the black spores are harmless unless there are barberry bushes near by. The question remains whether there are still other ways in which the rust can live through the winter.

HOW DOES RUST LIVE OVER WINTER?

There has been a popular belief that the rust lives over winter in the seed or in the red stage, as well as in the black stage. Considerable work has been done to determine just how the rust lives through the winter.

DOES THE RUST LIVE IN THE SEED?

There has been a belief among some people that the rust lives over winter inside the seed and then attacks the sprouting plants. If this were true it would be possible to control rust somewhat by selecting seed from unrusted fields. Furthermore, one serious rust year would likely be followed by another bad rust year. But two bad rust years seldom occur in succession, except in some regions where the rust probably develops during the entire year. If the rust lived in the seed during the winter, the sowing of rusted seed ought to result in the development of rusted plants. Carefully made experiments have shown that the rusted seed does not produce rusted plants. Hundreds of examinations of sprouting seeds show that the rust on the seeds does not infect the young sprouts.

DOES THE RED STAGE LIVE OVER WINTER?

For the past two years the Department of Agriculture has been studying the question of the overwintering of the red-spore stage. It is well known that the leaf rusts overwinter

in the red-spore stage. It has been shown clearly that the black stem rust does not overwinter commonly in the red-spore stage except in the extreme South and on the Pacific coast, where the rust can continue to develop on fall-sown grains practically throughout the winter. Thus, in the Gulf States and in California the red stage of rust can continue to develop practically the year round. However, it is perfectly clear that the rust does not overwinter commonly in the red-spore stage except in the extreme South, on the Pacific coast, and in some protected mountain valleys. Experiments in the winter of 1917-18 prove conclusively that the red stage did not live through the winter as far south as Jackson, Tenn. It was shown also that the rust did not overwinter in the red-spore stage in Oklahoma, Kansas, Missouri, Kentucky, Nebraska, or in any of the States farther north. All the evidence available at present shows that if the red stage of rust does live through the winter at all in the Northern States, it does this so rarely as to be of little importance in starting rust epidemics.

The question naturally arises whether the rust spores which overwinter in the South could not be blown northward in the spring and infect the growing grain. In this way the rust might travel from south to north by successive stages as the crop develops. Evidence based on careful observations shows quite clearly that this does not occur. The rust develops on barberry plants in the North and spreads to grains and grasses quite as early in the spring as the rust begins to become general in the South. Then, too, the form or race of wheat rust which is common in the South can not cause rust on hard spring wheats or on most of the hard winter wheats of the North. Even if the rust did blow up from the South, therefore, it could do very little damage in the North.

THE OVERWINTERING OF THE BLACK SPORES.

In the Gulf States the weather is mild enough to enable the red spores to live through the winter, but in the upper Mississippi Valley only the black spores live through the winter to any extent. In the spring they germinate and infect the barberry. The rust spreads from the barberry to grains and grasses and continues to spread as long as

weather conditions are favorable. Field observations show clearly that in the northern half of the Mississippi Valley the barberry gives the rust its start in the spring.

CONDITIONS WHICH FAVOR RUST DEVELOPMENT.

Weather affects the development of rust in several ways. It is plain that if rust is to develop and spread, the red or summer spores must be blown from plant to plant. Strong winds carry the spores long distances and therefore enable the rust to develop over a wide area. But even though the spores have been scattered widely they will not germinate unless the conditions of moisture and temperature are favorable. Heavy dews and fogs or steady, quiet rains furnish the best conditions for spore germination and consequently for rust infection. Heavy driving rains are probably not so favorable for infection, because they wash many of the spores from the plants on which they have fallen.

After the rust parasite has entered a plant it will develop most rapidly when the weather is rather hot and muggy. At low temperatures the rust develops much more slowly, and it may also be checked by hot, dry weather. The weather also may be favorable for infection but not for rust development after infection. Or it may be favorable for the growth of rust at one time during the season and not at another. When the right conditions occur at just the right times epidemics develop.

The variety of grain grown and the condition of the plants affect the rapidity of the growth of the rust parasite. Soil conditions influence rust development in so far as they affect local conditions of moisture and temperature and the growth of the grain plants.

HOW TO REDUCE RUST LOSSES BY CULTURAL METHODS.

Rust can not be prevented entirely, but the losses which it causes can be reduced. Proper soil management, early sowing, the use of early-maturing and resistant varieties, the destruction of weed grasses which can be attacked by rust, and the eradication of the common barberry all will aid in reducing rust losses.

SOIL MANAGEMENT.

Grain grown on high land usually does not rust as severely as that grown in low places. On account of poor air drainage, moisture remains on the plants longer in the low places, and the rust therefore has a better opportunity to develop. Whenever possible, high, well-drained land should be selected for grains in those regions in which rust is destructive.

Every possible means for hastening the ripening and the even development of the grain should be used. Rust develops most rapidly fairly late in the season, and early ripening often enables the grain to escape rust injury. The preparation and fertilization of the land are quite important. The seed bed should be prepared very thoroughly, in order that the plants may get a quick start.

The problem of proper fertilizing differs in different regions. In general, it is safe to say that the use of large quantities of nitrogenous fertilizers, especially on those soils which do not need them badly, will permit greater rust damage. Although the actual amount of rust may not be any greater on the plants fertilized with nitrogen, reduction in yield is almost certain to occur. The straw of plants fertilized heavily with nitrogen is often weak and crinkles badly when rust attacks it. The ripening also often is delayed, and the rust therefore has a longer time in which to spread and cause damage. As far as possible, while giving the plant what it needs, those fertilizers should be used which promote the development of stiff straw and cause early ripening. Plants fertilized with potassium or phosphate fertilizers usually yield better in bad rust years than those which have been fertilized with nitrogen.

EARLY SEEDING OF GRAIN.

The later the grain remains green the more chance the rust has to attack it. Anything therefore which can be done to hasten the ripening of the grain should be done. It is quite clear that early seeding, particularly of spring wheat, on a very well prepared seed bed and in soil which has been properly fertilized will cause the plants to develop rapidly

and reach maturity before the rust becomes widespread. It is a matter of common observation that in severe rust years early-sown grain often develops much better than that sown later in the season. The most serious epidemics often reach their height of destructiveness two weeks before the grain ripens. A difference of a week or 10 days in ripening, therefore, may determine the difference between a good yield and practically no yield at all.

EARLY VARIETIES OF GRAIN.

An early-maturing variety grown on properly prepared land often will yield well when later maturing varieties yield practically nothing. The variety selected should depend on its adaptability to the region in which it is to be grown.

The yield of the grain is, of course, the real test. The Marquis is a spring wheat which is very susceptible to rust, but it matures a week or 10 days earlier than most of the other spring-wheat varieties and for that reason sometimes escapes serious damage. No general recommendation for the use of certain varieties can be made, but it is well to remember that, if two varieties are otherwise about equally valuable, the earlier maturing one should be given preference in a district in which rust is likely to be destructive.

RESISTANT VARIETIES OF GRAIN.

There is some hope of reducing rust losses by the use of rust-resistant varieties. More is known about the resistance of wheat varieties than about that of any other kind of grain. It has been known for many years that some varieties of wheat do not rust as heavily as other varieties under the same conditions. The durum wheats, as a group, have been considered fairly resistant to stem rust. Not all varieties of durum wheat are resistant, but a great many of them are. This makes it possible to grow fairly good crops of some durum wheats when the bread wheats are injured severely by the rust.

Until recently no good bread wheat was known which was resistant to rust. A selection from the Crimean group made at the Kansas Agricultural Experiment Station several years ago, however, was tested for rust resistance and was found to be almost entirely immune under Kansas conditions. It

seemed, therefore, that the rust problem in the winter-wheat regions might be near solution. However, it has since been found that there are many races or forms of wheat rust. They differ from each other chiefly in their ability to attack different varieties of wheat. Some of the varieties of durum wheat which are quite resistant to rust forms in many localities are quite susceptible to the forms of rust occurring in other localities. In the same way, some varieties of hard spring wheat which rust most heavily in the spring-wheat region do not rust severely when grown in the extreme South. The Marquis and Haynes Bluestem were grown in the South and were almost entirely free from rust, while the native soft winter wheats in that region were rusted heavily. In the same way, the resistant Kansas variety, Kanred, was very resistant when grown in Kansas but rusted in some other parts of the United States.

No one variety now known is resistant to all the forms of rust which occur in the United States. No one rust-resistant variety of wheat, therefore, can be recommended for universal use. The problem is a local or regional one, and varieties should be selected with this in mind. As no general recommendations can be made, it would be well to consult your State agricultural college before sowing a supposedly rust-resistant variety.

It is perfectly clear, however, that rust resistance alone should not commend a variety of wheat for general use. It must combine other desirable characters with its rust-resistant quality. For this reason much crossing and selecting have been done to combine the rust-resistant character of some varieties with the high-yielding and good thrashing and milling qualities of other varieties. Some success has been attained, but not enough progress has been made to give any hope that the rust problem may be solved entirely in this way in the near future. Until it is known how many races of the stem rust there are, where they occur, and which varieties they can attack, relief by means of resistant varieties will be local or regional. Investigation of this character is being carried on by the United States Department of Agriculture in cooperation with several State agricultural experiment stations, and it is hoped that within a few years valuable information will be available.

ERADICATION OF WEED GRASSES.

Many wild grasses are dangerous carriers and spreaders of stem rust. Among those which rust most commonly and heavily are quack-grass, wild barley or squirrel-tail grass, slender wheat-grass, western wheat-grass, the wild ryegrasses, and orchard grass. Some of these grasses are bad and widespread weeds. Where they grow near barberries they almost always rust heavily early in the spring and then serve as centers of infection, from which the rust spreads to other grasses and then to grainfields. The rust-carrying grasses are so common that, together with the grains, they constitute what is in fact a continuous grainfield in many sections of the country. From the standpoint of good farming they should be kept down as much as possible by clean cultivation. Grasses growing along roadsides, fences, and in waste lands are a continual menace. They continue to develop rust after grain has been cut and so provide more rust from which to start epidemics the following spring. It is to be hoped that in the near future unused lands will be put under cultivation as much as possible. Every available means should be taken to destroy these weed grasses, because they spread rust in addition to the injury they cause as weeds. It is impossible to control rust by this method alone, but the general eradication of the weed grasses no doubt would reduce the amount of rust considerably.

ERADICATION OF THE COMMON BARBERRY TO REDUCE RUST LOSSES.

No one of the methods just discussed will prevent rust entirely, nor can a combination of all of them be depended on to do more than reduce somewhat its amount and destructiveness. The eradication of the common barberry and other rust-carrying species and varieties of barberry gives more promise of success than any other one control measure. The eradication of the barberry can not be urged too strongly; but the difference between harmful and harmless kinds, the parts of the country in which they are most important, and the results to be expected by removing them should be understood.

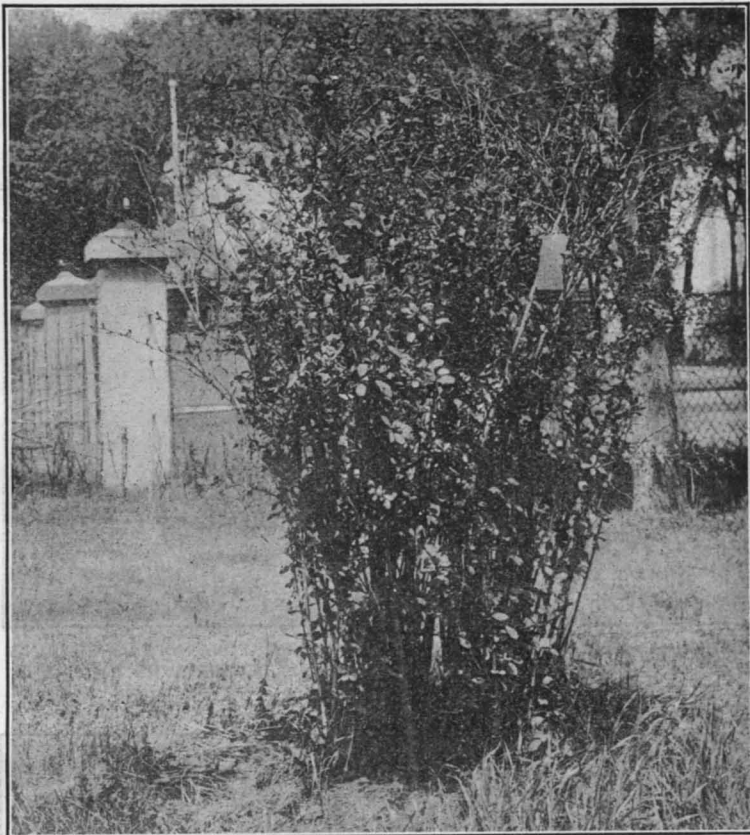

FIG. 1.—A COMMON BARBERRY BUSH, TALL AND ERECT. COMPARE WITH PLATE VI, FIGURE 1.

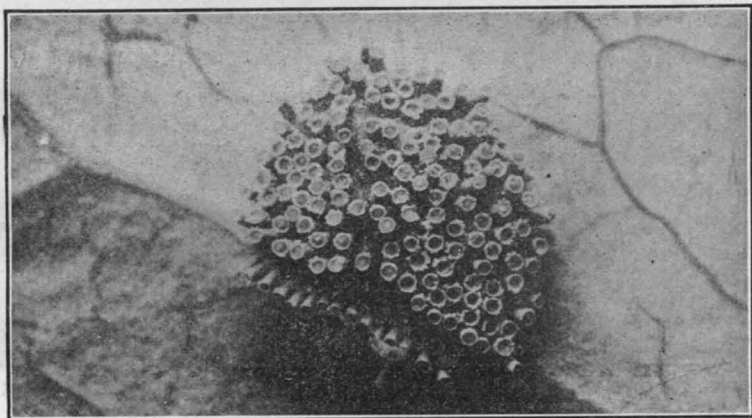

FIG. 2.—A PORTION OF A BARBERRY LEAF, GREATLY ENLARGED, SHOWING CLUSTER CUPS WHICH CONTAIN RUST SPORES.

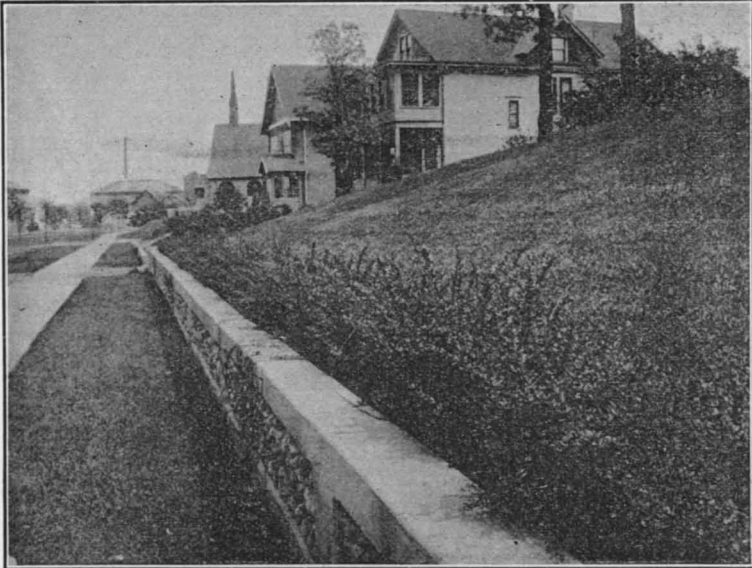

FIG. 1.—A HEDGE OF JAPANESE BARBERRY, LOW AND SPREADING GRACEFULLY. COMPARE WITH PLATE V, FIGURE 1.

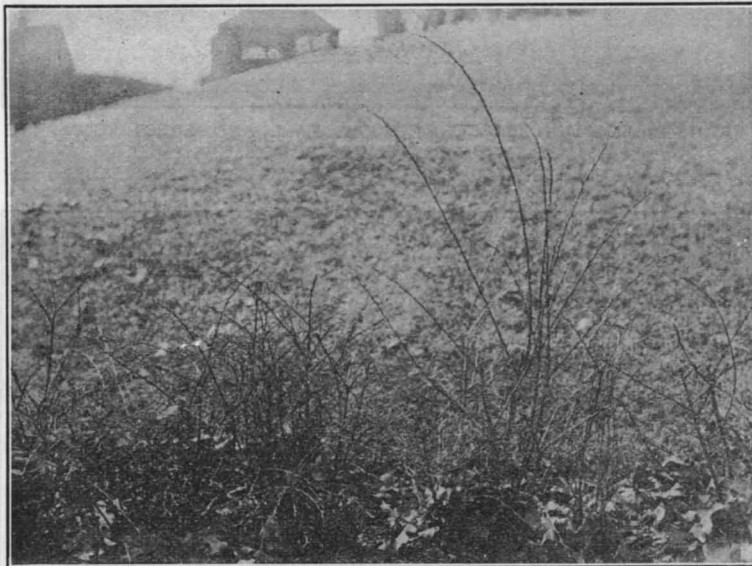

FIG. 2.—ONE COMMON BARBERRY BUSH IN A HEDGE OF JAPANESE BARBERRY. IT IS EASILY RECOGNIZED BY ITS HEIGHT.

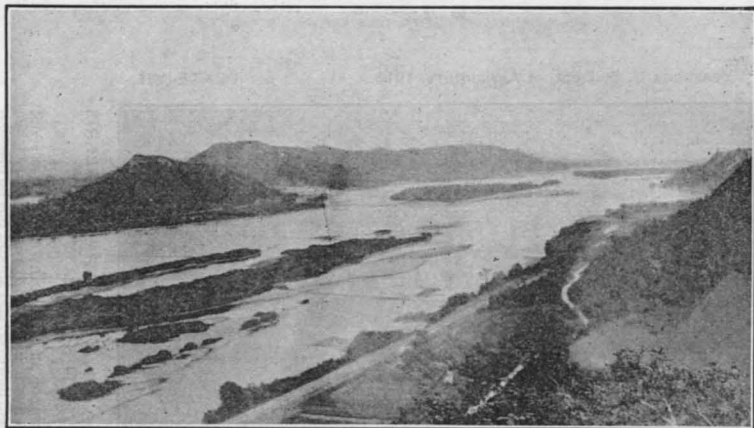

FIG. 1.—BLUFFS NEAR THE MISSISSIPPI RIVER BETWEEN WINONA, MINN., AND TREMPPEALEAU, WIS., ON WHICH ESCAPED BARBERRIES HAVE BEEN RUNNING WILD FOR 30 YEARS.

The bushes are up high where the wind scatters the spores for miles around. They are being located and dug.



FIG. 2.—BLUFFS ALONG THE MISSISSIPPI RIVER WHERE BARBERRIES HAVE BEGUN TO RUN WILD AND THREATEN DANGER TO THE CROPS IN THE VALLEY BELOW.

HARMFUL AND HARMLESS BARBERRIES.

Not all barberry species and varieties are harmful. The common European or high-bush barberry (*Berberis vulgaris*) is the commonest offender (Pl. V, fig. 1). The purple-leaved barberry is only a variety of the common barberry and rusts just as badly as the green-leaved form. The Japanese barberry (Pl. VI), also called the dwarf or low barberry (*Berberis thunbergii*), on the other hand, does not rust and should not be disturbed, because it not only is harmless but is also a very beautiful shrub. Various species of Mahonia (Pl. VII, fig. 1) also rust, but these bushes are not so commonly planted and are not so important in the development of rust as the barberry bushes. (See Pls. V, VI, and VII.)

There are many species of barberry, both harmful and harmless, but it can be stated that, as a general rule, those which resemble the common barberry carry rust and those which resemble the Japanese form do not. The two forms sometimes hybridize and the hybrids may rust even when they look almost exactly like the Japanese variety. A list of rust-susceptible and rust-resistant barberries is given later.

The two types of barberry can be distinguished from each other very easily. While it is easiest to tell them apart when the leaves are on the bushes, the presence of leaves is not at all necessary. They can be distinguished by their different habits of growth, the color of the bark, the number of the spines, and the grouping of the berries.

The common barberry (*Berberis vulgaris*) is a tall, erect shrub, often as much as 12 feet high. The bark is grayish in color, and there are spines along the stem (fig. 1). These spines are usually in groups of three or more, although sometimes only one or two occur. The leaves occur in clusters, are green or purple in color, and have saw-tooth edges (fig. 1). The yellow flowers and red berries are in long, drooping racemes like those of currants (fig. 1). The flowers are small and inconspicuous, but the red berries are numerous and easily seen, usually remaining on the plants throughout the winter. (See Pls. V and VI.)

The Japanese barberry (*Berberis thunbergii*) is a low, gracefully spreading shrub, seldom more than 4 or 5 feet tall.



**COMMON
BARBERRY**
BERBERIS VULGARIS

Leaves: Fairly large, with saw-tooth edges.
Spines: Long, and usually in groups of three.
Berries: In clusters like currants.

This kind spreads rust.

**JAPANESE
BARBERRY**
BERBERIS THUNBERGII

Leaves: Rather small, with smooth edges.
Spines: Fairly short and usually single.
Berries: One or two together.

This kind is harmless.

FIG. 1.—The common barberry and the Japanese barberry, showing the differences.

The bark is reddish in color and the spines (fig. 1) are smaller than those of the common form. They are usually single, but sometimes in twos and threes. The edges of the leaves have no teeth. The flowers are yellow and the berries are red, like those of the common form. But both the flowers and the berries are in very small bunches of two or three, like gooseberries, and not like currants (fig. 1). (See Pl. VI.)

Mahonia (*Mahonia* spp.) is a shrub with leaves somewhat resembling those of the common holly. The leaves are compound (that is, composed of several leaflets, like those of a pea), rather large and stiff, often with spines along the edges. The berries are blue. (See Pl. VII, fig. 1.)

The following list summarizes what is known now about the relation of different kinds of barberry and rust.

LIST OF BARBERRIES AND RELATED PLANTS.

The following species and varieties are known definitely to rust, although they do not all rust equally severely:

Berberis aetnensis, *altaica*, *amurensis*, *aristata*, *asiatica*, *atropurpurea*, *brachybotrys*, *brevipaniculata*, *buxifolia*, *canadensis*, *caroliniana* (*carolina*), *coriaria*, *cretica*, *declinatum*, *fendleri*, *fischeri*, *fremontii*, *heteropoda*, *ilicifolia*, *integerrima*, *laxiflora*, *lycium*, *macrophylla*, *nepalensis*, *neubertii*, *sieboldii*, *siberica*, *sinensis*, *trifoliolata*, *umbellata*, *vulgaris*, *vulgaris atropurpurea*, *vulgaris emarginata*, *vulgaris japonica*, *vulgaris purpurea*, *vulgaris spathulata*.

Mahonia aquifolium, *diversifolia*, *glauca*, *repens*.

The following forms of the common barberry may rust, but this is not certainly known:

Berberis vulgaris alba, *vulgaris asperma*, *vulgaris fructiviolacea*, *vulgaris lutea*, *vulgaris macrocarpa*, *vulgaris mitia*, *vulgaris nigra*, *vulgaris violacea*.

The following barberries are known not to rust:

Berberis thunbergii (Japanese barberry) and its varieties *maximowiczii*, *minor*, *pluriflora*, and *variegata*.

It is not known definitely whether the following rust or not. Some of them very probably do, while it is almost certain that others do not.

Berberis actinacantha, *angulosa*, *brachypoda*, *congestiflora*, *coryi*, *crassifolia*, *darwinii*, *diaphana*, *dictyophylla*, *empetrefolia*, *fortunei*, *francisci-ferdinandi*, *gagnepainii*, *guimpelii*, *heterophylla*, *jamiesonii*, *levis*, *linearifolia*, *lucida*, *macrophylla*, *nana*, *nervosa*, *pearcii*, *pinnata*, *prattii*, *pumila*, *regeliana*, *sargentiana*, *spinolusa*, *stenophylla*, *subcaulolata*, *thibetica*, *trifolia*, *verruculosa*.

DISTRIBUTION OF THE BARBERRY.

The common barberry is a native of Asia and was brought into Europe 400 or 500 years ago. It was cultivated as a fruit bush for hundreds of years until it was found to spread the rust of grains. The berries were used for preserves and jellies, and their juice was used for making wine and vinegar. The early colonists brought the bush to North America, and it has been more widely distributed year by year, although recognized as a menace to our grainfields. The bush was popular and the colonists carried the seeds or the bushes themselves with them when they went into new regions. Barberry bushes were planted around the first cabins which the settlers in the Middle West built. There are thousands of bushes in that section which are 40 or 50 years old. Many bushes as old as 60 or 70 years are still thriving. The settlers unknowingly brought with them the greatest enemy to their grain crops. The barberry was there as early as the grain. Nurserymen have been propagating and distributing barberry bushes for many years, although they have discontinued this practice to a considerable extent since they have learned its relation to the rust of wheat and other grains.

The barberry is especially common in cities, villages, and even in the country districts in the New England States and westward through the upper Mississippi Valley. It is very common in parks, cemeteries, and on public and private grounds, where it has been used in hedges and in clump plantings. Scarcely a village or city of any size in the upper third of the country is without some barberry bushes. The bush is not nearly so popular in the South. Naturally the barberry problem is much more serious in those regions where the bushes are most abundant.

THE COMMON BARBERRY RUNNING WILD.

The seeds of the barberry are carried by birds, and the bush has escaped from cultivation to some extent in this way. In the New England States large numbers of common barberry bushes are found growing wild in pastures and fields. Fortunately those States are not primarily grain-growing States or their problem would be discouraging indeed. But the barberry has escaped also to some extent in the grain-growing

districts of the Middle West. In Michigan, Wisconsin, Iowa, Minnesota, and other grain-growing States some wild bushes occur, although they are not so numerous as to make their eradication impossible. But one trembles to think of the effect on the great grainfields which furnish us our food if the barberry is allowed to go on spreading until it becomes common in the open fields. The wild bushes which do occur now are mostly along the banks of rivers or on rocky hills (Pl. VIII), especially where there is limestone. Of course, the spreading of the bush in these rocky places makes it all the more dangerous, because it is hard to kill when it has established its root system in the crevices of the rocks.

NATIVE BARBERRIES.

There are also several sorts of native barberry. These occur in the southern Appalachian region, in the States of the southern Great Plains area (Pl. VII, fig. 2), and in the Rocky Mountains. Some of them are susceptible to rust, but on account of their location and the fact that some of the commonest kinds do not rust easily, they seem to be of very little or no importance in developing rust. The presence of these sorts, therefore, does not constitute an argument against the eradication of the common barberry, which has been shown time after time to spread rust. All the evidence now indicates that the native barberries do not play an important part in the development of rust epidemics. However, some of the native kinds will rust severely when planted in regions in which grains are grown commonly, and they should not be planted.

HOW SEVERELY DO BARBERRIES RUST?

Barberry bushes rust much more commonly and heavily in the Northern States than in those farther south, although rusted bushes have been found as far south as central Tennessee. They apparently rust quite generally in northern Missouri and northern Kansas, but they are more generally and severely rusted in Nebraska, Iowa, Colorado, and the States farther north. However, it is safe to say that common barberry bushes when near grainfields may be dangerous even in the South.

The amount of rust on the barberry depends largely on weather conditions and the proximity of grains and grasses. When the weather in the spring is moist and warm the bushes may rust heavily. Usually they begin to rust early in May and may continue to become rusted throughout the entire growing season. Rust has been found on them as late as October. They may therefore continue to spread rust during this entire period. Rust develops not only on the bushes near grainfields but also on those in villages and cities. Barberry bushes develop an enormous amount of rust, and this rust spreads destruction to wheat and other grains.

THE SPREAD OF RUST FROM THE BARBERRY.

It is a matter of common observation that the rust spreads quickly from barberry bushes to the grains and grasses in the immediate vicinity (Pl. IX). The spores from the barberry are carried by the wind, and within a week from the time the rust first appears on the bushes the grains and grasses within a few rods of the bushes begin to rust. As far north as Minnesota and Wisconsin susceptible grains and grasses near the rusted barberry bushes are often red with rust by the middle of May. These red spores are carried many miles by the wind, and the rust from the first rusted grasses and grains can infect those at considerable distances. Then infection spreads from these plants to others, and thus the rust travels by successive steps. In this way the effect of a single bush often extends for many miles.

The following typical cases show more clearly the effect of barberry bushes on grains. Hundreds of similar cases could be cited. Practically all of the barberry bushes which caused the damage have been dug. Fourteen farmers in Indiana saw so clearly the effect of the barberry on wheat rust that they made the affidavit which is given here with names omitted:

We, the undersigned farmers of Wabash County, Indiana, at a meeting at the ——— farm, in Noble Township, on July 19, 1918, called for the purpose of observing the ravages of the black stem wheat rust on the 17-acre wheat field, desire to go on record as follows:

1. We are fully convinced after making these observations that there is a connection between the common barberry and the black stem wheat rust. On the south side of this ruined field is a large planting of common barberry bushes which have been badly infected

by the rust. We have observed that the rust started on the side of the field next to these bushes and that now the worst infestation is on the side nearest the barberries.

2. We desire to go on record as favoring any legislation looking toward the complete eradication of the common barberry bush, believing it to be of no value, but, on the other hand, a serious menace to the wheat-growing industry.

In Ohio several striking cases of the spread of rust from barberries were seen in 1918. The quotation given below illustrates one of them. There was scarcely any stem rust in the region except that which clearly came from the barberry.

In southwestern Green County, about 1 mile south of Bell Brook, Mr. ——— had a hedge of severely rusted barberry. He has 20 acres of wheat practically destroyed by stem rust. His neighbor, across the road, secured permission to put hogs on 20 acres of wheat that was so nearly destroyed by rust that it would not be worth cutting.

Near Lake Preston, S. Dak., common barberry bushes were scattered along the roadside for a distance of half a mile in a grain-growing region. Practically all the bushes were heavily infected with rust. The nearest grainfield was a field of barley about 400 feet west of the bushes, but there was a great deal of wild barley or squirrel-tail grass near the bushes. On July 20 the grass and grain were carefully examined. The weather had been hot and dry, and rust had not been spreading rapidly. In spite of the unfavorable weather, however, it was very clear that the rust had started from the bushes and had spread to the grasses, to barley, and to wheat fields within a distance of $2\frac{1}{2}$ miles. Between July 20 and 30 there was a period of rainy weather. On July 30 the fields were again examined and the rust had developed so rapidly that the wheat was severely injured as far as $2\frac{1}{2}$ miles from the bushes. The rust had spread to wheat fields 5 miles from the bushes. The effect of the bushes was so clear that 27 farmers drew up and signed the statement given below:

Since the common barberry harbors the black stem rust of the wheat in the early spring and thereby starts an early and serious infection of rust, particularly because of the barberries on two farms south of town which are known as the ——— farms, where for many years early and serious stem-rust infection has been noted and is due to the presence of the barberries, we, the undersigned, believe that in

order to protect the wheat crop of South Dakota from the rust infection caused by the common barberry, there should be a special barberry law in South Dakota making it a crime to propagate, grow, or have growing on any public premises any of the common rust-susceptible varieties of barberry.

During the summer of 1918 scarcely any stem rust appeared in Montana. The weather had been extremely dry and therefore unfavorable for rust development. However, several reports of severe stem-rust infection, sent to the Montana Agricultural College and the United States Department of Agriculture, showed that every one of the rust outbreaks that occurred in Montana during 1918 was directly traceable to infected barberries.

At Diamond Lake, Minn., a barberry hedge of 15 bushes was found heavily rusted on June 20, 1918. The infection was traced from wild barley growing along the street to a wheat field located one-fourth of a mile northeast from the hedge. At this date the only stem rust in the wheat field was in the southwest corner, the part nearest to the hedge and infected grass. No rust was found in similar grass on the opposite side of the field. Thus, it was very evident that the barberry was responsible for the rust infection in the wheat field. The locality was visited again on July 25, and at that time the rust was common throughout the field.

A farmer at Crystal Bay, Minn., had a barberry hedge of 635 bushes. He had tried to grow oats on his farm for the past 10 years, but each year the black stem rust destroyed almost all of the grain. In May, 1918, the farmer destroyed the barberry hedge before the bushes had become rusted. The field was examined thoroughly 10 days before harvest and no stem rust could be found. The yield was excellent and the quality of the grain good. This was the first time in 10 years that a crop had been grown successfully.

At Woodlawn Cemetery, Sioux Falls, S. Dak., there was a large hedge of the common barberry. These bushes became rusted early in the spring of 1918. A great deal of squirrel-tail grass grew near the barberry bushes, but the nearest wheat fields were three-fourths of a mile away. By July 22, in spite of weather unfavorable for rust, the rust had spread to the grass and from the grass to the nearest field of wheat, three-fourths of a mile away, and to other fields 1 mile away.



FIG. 1.—OLD NEGLECTED HEDGE OF COMMON BARBERRY SURROUNDED BY GRASSES WHICH RUST HEAVILY EVERY YEAR AND SPREAD THE RUST TO NEIGHBORING GRAIN FIELDS. THESE BUSHES HAVE BEEN DUG.

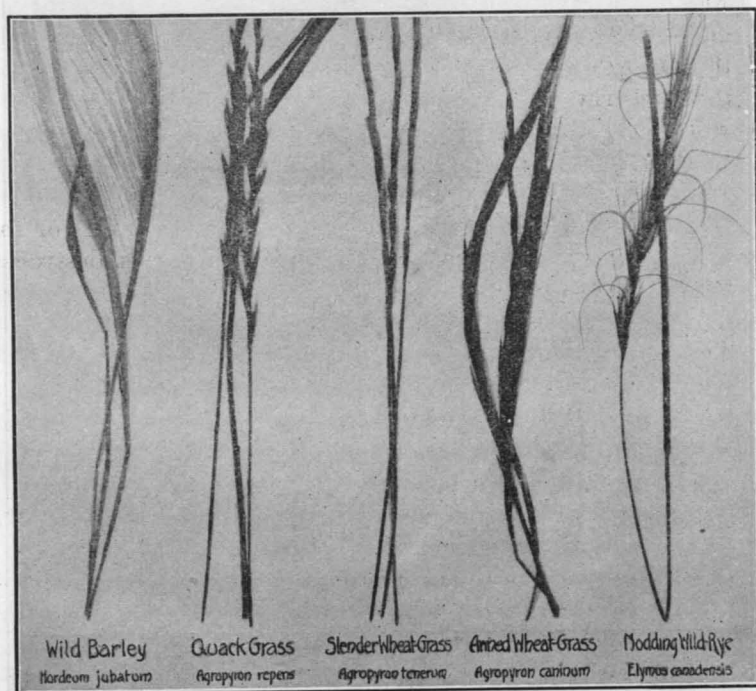

FIG. 2.—SOME COMMON WILD GRASSES WHICH RUST HEAVILY.

The rust can spread from these grasses to grain as well as from grain to other grains.

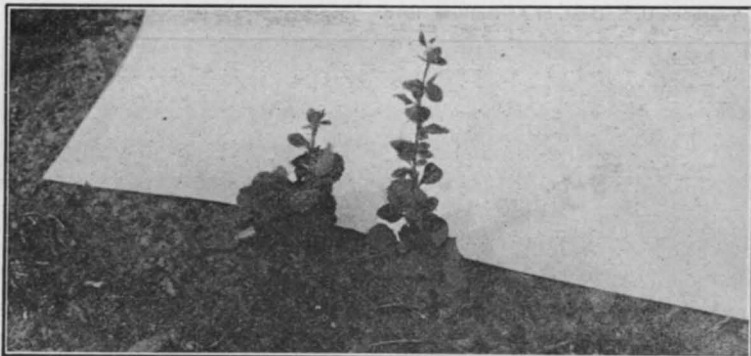

FIG. 1.—THESE SPROUTS OF COMMON BARBERRY GREW FROM PIECES OF ROOTS LEFT IN THE GROUND WHERE A BUSH WAS DUG. DIGGING MUST BE COMPLETE AND THOROUGH.



FIG. 2.—THE PROPER WAY TO REMOVE BARBERRY BUSHES. DIG DEEP ENOUGH TO GET ALL OF THE ROOTS.

The nearest field was very severely rusted, while the rust on those 1 mile distant was not quite so heavy. This shows clearly that barberry bushes in cities may cause rust on grains by going first to grasses and then to grains. The bushes have been destroyed.

IMPORTANCE OF THE BARBERRY IN SPREADING RUST.

There can be no question whatever that the barberry is the most important factor in the spread of rust in the northern half of the Mississippi basin. In the South it is less important.

There are large numbers of barberry bushes. They rust commonly, and the rust spreads from them directly to grains, or to grasses, and then from the grasses to grains. There are few grainfields in the Middle West which are more than 25 miles from a barberry bush. Rusted bushes were found in practically every county in Wisconsin in 1918. Barberry bushes were found in all but three counties in Minnesota, and these three counties were in the extreme north, where farm land is just beginning to be developed. Every county in Iowa contained the common barberry, and the same is probably true of every other Middle-Western State. About 95,000 bushes, exclusive of those in nurseries and those growing wild, were found in Wisconsin in 1918, while patriotic Minnesota nurserymen destroyed about 600,000 bushes, and at least 50,000 were located on private and public grounds. About 85,000 bushes were found during a preliminary survey of northern Illinois, and 25,000 were found east of the Missouri River in South Dakota. The bushes were numerous and commonly rusted also in North Dakota, Montana, Wyoming, Colorado, Nebraska, Michigan, Indiana, and Ohio. No systematic survey was made in other States, but it is known definitely that there are many bushes and that they rust heavily in the States near those just named. While most of the bushes are in cities and villages, they have also been planted fairly extensively in country districts. Long hedges were often growing as fences beside grainfields, and numerous smaller plantings were found. Barberry bushes rust early in the season and the cluster-cup spores may be blown considerable distances by the wind. But even

if they were not blown far, the effect of a single bush could extend to grainfields miles away because the rust can spread from the bushes to near-by grasses or grains and then, in turn, to other grains and grasses. Since the rust may have started from the bushes by the middle of May, the amount of spread by midsummer can be very great.

Studies made up to the present show that the red stage of the rust does not persist commonly north of the Gulf States and that it does not spread from the south to the north. The first black stem rust which can be found in the Northern States in the spring always occurs near the leeward side of barberry bushes. The rust spreads from the bushes in the direction toward which the prevailing wind blows.

The barberry, therefore, enables the rust to start early in the spring, it increases the amount of rust, and in many regions of the country it furnishes the only means by which the rust can persist from one season to another and get an early start in the spring. The value of our grain crops is enormous; the value of the common barberry is as nothing in comparison. The Japanese barberry is harmless and is more beautiful than the common form. The common barberry should be eradicated.

BARBERRY LAWS.

Attempts to eradicate the common barberry have been made for 200 years or more. The movement is therefore not a mushroom growth, but, on the other hand, it is a gradual and healthy development of a sane idea based on years of careful observation and scientific demonstration.

There is some evidence that a barberry eradication law was passed in Rouen, France, as early as 1660. Connecticut, Rhode Island, and Massachusetts all enacted laws against the barberry between 1726 and 1766. The Connecticut and Rhode Island laws were renewed after a period of years, so the results must have been satisfactory.

Several European countries passed laws against the barberry shortly after 1800. Various States in Germany required the eradication of all barberry bushes within a certain distance from grain fields, while still others required all barberry bushes to be removed within a certain specified time. Denmark, in 1869, passed a law which gave any person the

right to demand the destruction of shrubs which were known to spread plant diseases. One of the provinces of France took advantage of a law passed in that country in 1888 and carried on an energetic campaign against common barberry bushes.

It is difficult to determine the effect of these old laws, because apparently many of them were not rigidly enforced. However, in certain localities in England, on the island of Aero, and, in various other places, the eradication of the barberry was followed by the disappearance of stem rust. Most of these laws were passed before the exact relationship between the barberry and the rust was known. The scientific proof of the relationship was not made until 1865. The early laws, therefore, are the best possible evidence that farmers realized clearly that barberry bushes increased rust, because at the time that these laws were passed people were not biased by any scientific statements regarding the matter.

Recently the movement for barberry eradication has gained great headway. The reason for this fact is that there have been several terrible epidemics of stem rust. These epidemics stimulated investigation of the exact methods by which the rust lived over winter and started in the spring. The evidence against the barberry became so clear and convincing that strong sentiment developed for the removal of the bushes.

For several years a law has been on the statute books of Ontario, Canada, requiring the destruction of the barberry. Recently Manitoba and Saskatchewan have also outlawed the common barberry. In the United States several States have enacted barberry-eradication laws. The Legislature of North Dakota passed such a law in 1917, while during 1918 Colorado, Nebraska, South Dakota, Minnesota, Iowa, and Michigan took legal measures to secure the complete eradication of the common barberry. At this time (April, 1919) bills are also pending before the Legislatures of Wisconsin and Illinois. The fight against the barberry, therefore, is on in earnest. These laws have not been in force long enough to determine their effect, but it is safe to say that the bushes will be completely removed from the upper Mississippi Valley within a few years and that rust attacks will become less frequent and less severe.

DENMARK CONTROLS RUST.

Practically all common barberry bushes have been eradicated from Denmark since the eradication law of 1903 was passed. The evidence in that country is conclusive. The eradication of the bushes has been followed by unexpectedly beneficial results. The stem rust has done no serious damage since the bushes were removed, although previously it had caused great losses. According to the Danish authorities, all rust attacks which have occurred during the last few years have been very clearly due to the presence of a few barberry bushes which had escaped notice and had not been removed. The results have been so clear that the owners of bushes have destroyed them rapidly.

It is evident, therefore, that Denmark has solved its rust problem by destroying the barberry. In the United States there have been two severe epidemics, causing enormous losses, and several less destructive ones since 1903.

Danish agriculturists visiting in the United States in the last few years have been entirely unable to understand why barberry bushes were permitted to grow in such large numbers in the grain-producing districts of this country.

DIG UP THE COMMON BARBERRY.

All common barberry bushes should be dug up immediately, especially in the grain-growing States. The plants should not be merely cut off, but should be dug up, root and branch (Pl. X, fig. 2). All the roots should be removed carefully, because new sprouts (Pl. X, fig. 1) are likely to grow from them. The place from which the bushes were removed should be watched for several years and any sprouts which appear should be dug up and burned. The Japanese species is harmless, but every common barberry bush in the United States should be destroyed. Thousands of bushes have already been destroyed, but thousands remain as a standing menace to our grain crops. Every bush destroyed gives additional insurance to wheat, oats, barley, and rye. Destroy the barberry and protect the grain.

CATTLE LOANS AND THEIR VALUE TO INVESTORS.

By CHARLES S. COLE,

Investigator in Rural Organization, Bureau of Markets.

CATTLE LOANS are made on live stock, cattle in particular, to provide funds for developing and finishing the animals for market. From the point of view of the lender, the loan is primarily a banking proposition, having for its object the profits which accrue through interest. The packing interests, however, are interested in many of the largest cattle loan companies, and have as an additional object the sustaining and development of the industry as a whole. They are influenced not only by the profits they can make out of loaning money but in keeping a steady flow of animals into their plants.

CATTLE LOAN COMPANIES.

Large sums in the aggregate are loaned direct to producers by local banks; but, in general, cattle loans are thought of as loans made through cattle loan companies. These companies exist in all large live-stock markets, and some have been organized in producing centers. Many of the largest of them are affiliated with large banks located at the stockyards of the most important central markets. Although the companies are separate from the banks as organizations, yet often the officials of the banks are also the officials of the cattle loan companies. The reason given for the organization of companies affiliated with banks is that banking laws so limit the size of loans that banks can not handle the larger loans, which are the most desirable ones from the standpoint of profit. The funds necessary for the carrying on of the business of these companies are obtained by rediscounting cattle paper.

Among the officers of the company is sometimes found a practical cattleman who not only passes on the loans but also inspects the collateral offered as security. In some companies inspectors are employed whose duties are to travel over the territory where loans are made and make

inspections of the ranches, cattle, and facilities for handling them at least once during the life of a loan. Other companies have inspectors who are located in the various localities where loans are made and who are subject to call for inspection purposes. They are paid when actually employed and keep in touch with conditions in their territory.

MAKING A LOAN.

The making of a loan is well standardized and usually includes the following procedure:

Application.—The applicant for a loan is furnished a blank to be filled out, which requires, after stating the amount he desires to borrow, that he make a sworn statement of his financial condition. This statement includes a description of the stock he has to offer as collateral, and the facilities for taking care of it, the amount of real estate he owns or has leased, and all outstanding mortgages and obligations.

Confidential inquiries.—The company, if it does not already have such information on file, verifies the statement submitted by the applicant by inquiry through banks and other agencies.

Searching the records.—The county records are then searched to ascertain whether the applicant's financial statement is correct as to outstanding obligations.

Inspector's report.—If the company is satisfied as to the security offered, an inspector who is a practical cattleman is sent out to make personal inspection of the facilities for caring for the stock, the amount of feed on hand, and the general reputation of the applicant as a cattleman; to count the cattle; and to determine whether they correspond with the description given in the application. The loan is generally made or rejected on the inspector's report.

Note and mortgage.—If the application is approved, the applicant is required to make out a note for the amount asked and to execute a chattel mortgage on the stock and its increase, together with the feed on hand. Sometimes the mortgage also includes the facilities for handling the stock, such as horses and machinery.

The business reputation of the applicant, his honesty, his reputation as a cattleman, and the collateral offered are the

factors that determine to a large extent whether a loan shall be made. Meeting obligations promptly and without resort to technicalities is of primary importance in obtaining credit. Persons with known ability to care for their stock and with sufficient collateral find it difficult to obtain credit if they have a reputation for taking advantage of technicalities in meeting their obligations.

Ability to handle stock properly and advantageously is essential if the safety of the loan is not to be impaired. The growth and development of stock furnishes a margin of safety, since this is depended upon to care for declines in the market. The collateral taken is supposed to be sufficient to take care of any normal market fluctuations and the growth of the stock is supposed to take care of unusual declines. It is apparent, therefore, that the cattleman's ability properly to take care of his stock is fully as vital as the collateral he offers.

The amount loaned is from half to full value of the stock. It is customary to loan from 75 to 80 per cent of the value of the stock on the ground that 20 to 25 per cent is ample margin for safety. Sometimes, especially in the case of feeders, if the applicant has a reputation for finishing his stock for market and has ample feed, he can obtain a loan equal to the market value of his stock at the time of borrowing. The condition of the market has a bearing upon the making of such loans. Unlike other collateral, live stock becomes more valuable by growth and by increase. Because of these two factors the hazards of loaning are greatly reduced and the margin required for safety need not be as great as that ordinarily required in loans on other chattels. The conservative loaning agency, however, requires a safe margin in addition to the feed on hand, except in cases where the applicant's financial ability justifies the loan on grounds other than the collateral offered.

NATURE OF THE LOAN.

The size of loans ranges from a few hundred to a million dollars. Small loans are more advantageously negotiated through local agencies, since they are familiar with the applicant and his financial standing and do not have the expense of inspection. If the loan is not of such a size as

to justify this expense, cattle loan companies can not afford to make it unless they are familiar with the applicant's financial ability and can make the loan regardless of the collateral offered.

Cattle loans are short-term paper, generally running for a period of six months. This time is adopted because of the rediscount feature of the cattle loaning business and because that length of time will ordinarily be long enough for the "feeding out" of a bunch of cattle. In the case of loans on stockers and breeders, there is an understanding that they will be renewed if desired.

INTEREST RATES.

Interest rates fundamentally rest upon the rediscount rate and upon competition. In other words, they depend upon the ease or difficulty of getting money in financial centers and upon the desirability of the individual loan. Interest rates have a tendency to rise or fall as rates in rediscount centers rise or fall. Slight variations in rediscount rates would have little or no effect on interest rates, but any marked fluctuations would immediately affect the rates charged on loans. Where money is plentiful and easy, competition tends to force interest rates down on all loans, but even when the money market tightens up, competition affects rates on desirable loans.

The size and the cost of making the loan, including inspection, are the factors which affect rates on individual loans. The size of the loan has a direct bearing on the rate, since the expense of making a small loan is much larger relatively than that of making a large loan. In fact, unless the financial standing of the applicant is such as to justify the loan without inspection, a small loan can not be made at a profit. The cost of inspection also has a vital bearing upon the interest rate, since this cost, with the exception of overhead expense, is the largest single factor chargeable against the expense of making a loan. Remote and isolated locations make inspection difficult and expensive, and the cost, therefore, is directly influenced by the accessibility of the collateral. The reputation of the applicant as a cattleman not only affects the question of whether the loan shall

be made, but also has a direct bearing upon the rate. If his reputation as a cattleman is such as to justify a loan, the quality of such reputation will affect the interest rate.

REDISCOUNTING THE LOAN.

Loans are rediscounted locally and in large financial centers. The cattle loan company forwards the note, together with the chattel mortgage, and sometimes copies of the inspector's report and the financial statement of the maker to the bank. It also indorses the note and thus guarantees its payment. The value of the guaranty lies in the character of the company and in its capital stock. Eastern banks, which are large purchasers of cattle paper, pay particular attention to the financial and business reputation of the companies offering paper for sale. They carefully scrutinize both the collateral back of cattle paper and the organization making the loan. Cattle loan companies establish affiliations with strong banks that are in the market for commercial paper, and carefully guard all financial transactions with them. In this way their credit is established, and they usually have a ready sale for their paper. In the cattle loaning business, as in all matters of credit, character is a prime factor. The importance of the rediscount feature is apparent when it is realized that companies with a capital stock of \$100,000 loan many times that amount on cattle in a year.

In most cases the spread between the interest rate and the rediscount rate is from $1\frac{1}{2}$ to 3 per cent, although it is usually from 2 to $2\frac{1}{2}$ per cent. It is generally claimed that the cost of making a loan is from 1 to $1\frac{1}{2}$ per cent, other things being equal, the cost decreasing with the size of the loan. The difference between the cost and the spread represents the profits of the company, and is the share it takes for assuming the risk and making available a constant source of credit to responsible borrowers.

SAFEGUARDING THE LOAN.

It is doubtful whether any other commercial paper is more carefully safeguarded than are cattle loans. Responsible agencies make exhaustive inquiries into every phase of risk connected with the loan. The applicant's business reputa-

tion, his ability as a cattleman, his financial standing, and the collateral offered as security are all subjected to investigation. In addition, practically all loaning agencies are members of the various State cattle raisers' associations. The brands and descriptions of cattle offered as collateral are recorded with these associations by the loaners of money. The associations keep inspectors in all the large central markets, and when cattle appear on the market carrying the brands of those mortgaged for loans, the commission firms handling them are notified and the amount of money for which the animal sells is automatically turned over to the holder of the note and mortgage. In this way lenders of money are protected against losses by theft and by the accidental selling of individual animals.

The chief concern, however, of the buyer of cattle paper should not be whether all the usual requirements of loaning money on cattle have been met, but whether the reputation of the company that made the loan justifies the conclusion that these requirements have been rigidly and thoroughly complied with. The indiscriminate purchase of cattle paper based only upon the apparent sufficiency of the collateral is fraught with hazard. Like other commercial paper, the real basis for confidence rests in the integrity and business sagacity of the agency making and guaranteeing the loan.

LIQUIDITY OF THE LOAN.

A marked feature of cattle loans is their liquidity. Short-term paper is demanded by banks, since it keeps their finances liquid and in a readily available state. The vicissitudes of business, however, as well as the desires of the borrower, make the renewal of ordinary short-term paper, with slight curtailments, a common and necessary practice. While renewals are necessary on stockers and breeders, requests for renewals are unusual in the case of cattle that are being fed for market. They must be marketed when they are finished. Any lengthy delays will result in loss. Loans made on this class of stock automatically liquidate themselves. The cattle virtually walk up to the teller's window and pay the loan. This feature of cattle paper adds to its desirability as an investment.

SERVICE RENDERED BY CATTLE LOAN COMPANIES.

The services which cattle loan companies render may be summed up as follows:

1. They make readily accessible to responsible borrowers financial assistance in large volume. The cattle industry in the range country is conducted on a large scale. Large sums are needed for its maintenance. Local agencies are seldom able to furnish these sums because of lack of capital and of legal limitations. Loan companies furnish capital to responsible persons in the needful amounts.

2. They furnish funds at rates generally not in excess of and sometimes under the prevailing local rate. Desirable loans are sometimes obtained at advantageous rates because of the element of competition.

THE BUYER OF CATTLE PAPER.

The conservative buyer of cattle paper will take into consideration certain fundamental factors.

1. He will carefully scrutinize the collateral back of the note. He should be familiar with market values of animals so as to be able to determine whether the collateral is sufficient. The margin of safety in the loan becomes a fundamental protection.

2. He will obtain full information as to the business ability and integrity of the agency making and guaranteeing the loan. For the average purchaser, this factor is the most essential one to consider. The safety of the loan depends not only on the agency's honesty but on its business ability as well.

3. He will exercise particular caution in purchasing split loans. When a borrower obtains money on his cattle from two or more agencies, his loans are called split loans. Such loans are particularly hazardous, since they afford opportunity for sharp practices by dishonest borrowers. Many agencies refuse to make them. Split loans should be dealt in only by experienced purchasers of cattle paper.

4. Loans bearing unusually high interest rates should be scrutinized. High interest rates are indicative of out-of-the-ordinary conditions, and among these conditions may be an unusual risk.

THE BORROWER ON CATTLE SECURITY.

The borrower of money for the purpose of developing and finishing his cattle for market is interested in certain factors which are vital to him.

1. He is interested in the character of the company from which he borrows. It should do a conservative business, for its ability to care for him in time of financial stress depends upon the safeguards with which it surrounds its loans. He is especially interested in whether it has the reputation of taking care of its borrowers. Should he be compelled to market his cattle at an inopportune time because of the calling of a loan, it might mean serious loss.

2. He is interested in the rate that he has to pay for money. If he is negotiating a loan of moderate size, he can not expect, under ordinary conditions, to obtain it at a preferred rate. He should not be obliged, however, to pay more than the prevailing rate. A high rate would indicate either that there was lack of competition or that his loan was considered more hazardous than the average. Generally the borrower can eliminate the element of unusual hazard; his credit rests primarily on his reputation, and this can be established.

BENEFIT TO THE INDUSTRY.

The importance of cattle loans is evidenced by the fact that several hundred millions of dollars are put out yearly by established loaning agencies in large central markets. The safeguarding of these loans through well-established practices has a direct and important effect upon the cattle industry as a whole, since a steady flow of money into the industry is dependent upon the reputation of cattle paper in financial centers. During the last few years the losses on cattle paper have been few. This has been due to a gradually rising and well-sustained market and to the care that loaning agencies have exercised in making loans and in protecting the reputation of cattle paper. The borrower, as well as the loaning agencies, has been a beneficiary, for money has been made more steadily available in needful amounts. The cattle industry, especially the ranching end of it, like any other large industry, is dependent upon credit, and every legitimate agency which opens up credit sources and establishes them through standardized practices performs a useful service.

BETTER POULTRY THROUGH COMMUNITY BREEDING ASSOCIATIONS.

By J. W. KINGHORNE,

Animal Husbandry Division, Bureau of Animal Industry.

COMMUNITY ASSOCIATIONS FOLLOW EDUCATIONAL WORK.

THE Petaluma district of California, the Little Compton section of Rhode Island, and the Vineland community of New Jersey have received national recognition as important producing centers of poultry and eggs. Yet, probably these districts would be heard of but little had they not centered effort on one breed of poultry. A community interest in any one type, breed, or variety of live stock is one of the greatest steps toward better and more profitable agriculture that a rural section can inaugurate. Community poultry-breeding associations are the natural and logical outgrowth of poultry educational work. In numerous cases, they have followed activities by the United States Department of Agriculture and State agricultural colleges in encouraging boys' and girls' poultry clubs.

CONCENTRATION ON ONE BREED PROFITABLE.

Besides the various general advantages derived through cooperative effort, a community poultry-breeding club creates additional interest by centering all its efforts on one breed or variety of fowl. Under such an arrangement all the members raise the same kind of poultry, and consequently their interests are mutual. The best methods of handling and breeding the accepted breed or variety soon become common knowledge so far as the association is concerned, and each member's experience is of value to the other members. Thus by concentrating all their efforts on one breed of poultry, the members build up a local industry that eventually becomes known as an important source of supply for fowls and eggs for market, eggs for hatching, breeding stock, and day-old chicks.

More than that, cooperative community poultry-breeding associations can be developed further to include cooperative buying. This is a direct means of reducing considerably the cost of feeds, supplies, and other necessary materials. Establishment of community breeding centers does not imply that the members of the association are engaged in the production of poultry to the exclusion of other farm products. On the other hand, most of the poultry-breeding organizations that have been fostered by the Department of Agriculture and State colleges have been in communities where general farming is practiced.

Development of community poultry-breeding associations has been especially noteworthy in Kentucky, North Carolina, Tennessee, and Virginia. In practically every case the interest in poultry keeping, which is now evident on all sides, is in marked contrast to the former careless methods and lack of interest.

EXAMPLES OF COMMUNITY ACCOMPLISHMENT.

A striking example of community breeding accomplishment is furnished by the Barred Plymouth Rock Association, Farmville, Va. Organized for poultry improvement in 1915, this association has made such continuous and rapid growth that it has been incorporated, with a capital stock of \$1,500, and a manager employed to handle its affairs.

Receipts during the first five months of operation amounted to \$7,500, and recent reports show that members of the association have on hand more than 6,000 Barred Plymouth Rock hens and pullets. In the spring of 1916 they sold 1,000 capons on a northern market.

Before the Farmville association was formed, poultry keeping in that locality was merely incidental, an unimportant side line to other farm activities. To-day poultry keeping is one of the important industries of that region, and even the casual traveler is impressed with the large numbers of Barred Plymouth Rocks on farms.

Another excellent example of the change following community breeding is found in Kentucky, where 17 counties have effected organizations. Each has selected a definite breed, and more than 83,000 eggs from standard-bred fowls have been distributed among members of the associations.

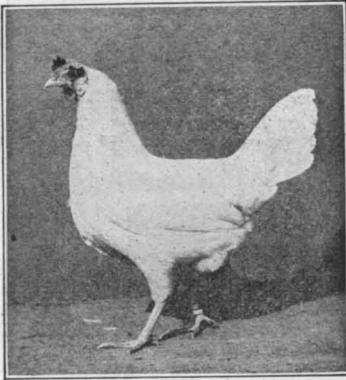

Fig. 1.—Single-comb white Leghorn pullet.

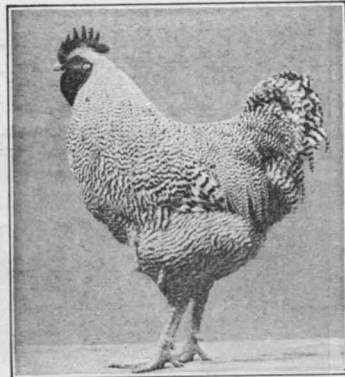

Fig. 2.—Barred Plymouth Rock cock.



Fig. 3.—White Wyandotte cockerel.

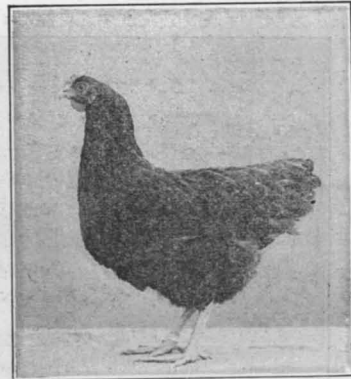

Fig. 4.—Single-comb Rhode Island Red pullet.

REPRESENTATIVES OF SOME OF THE BREEDS MOST COMMONLY SELECTED BY COMMUNITY BREEDING ASSOCIATIONS.

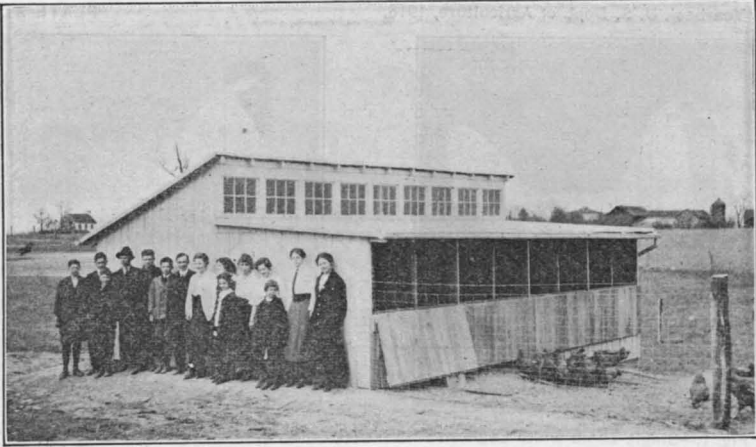

FIG. 1.—COMMUNITY POULTRY-BREEDING HOUSE AND COMMUNITY POULTRY CLUB AT MIDDLETOWN, VA.

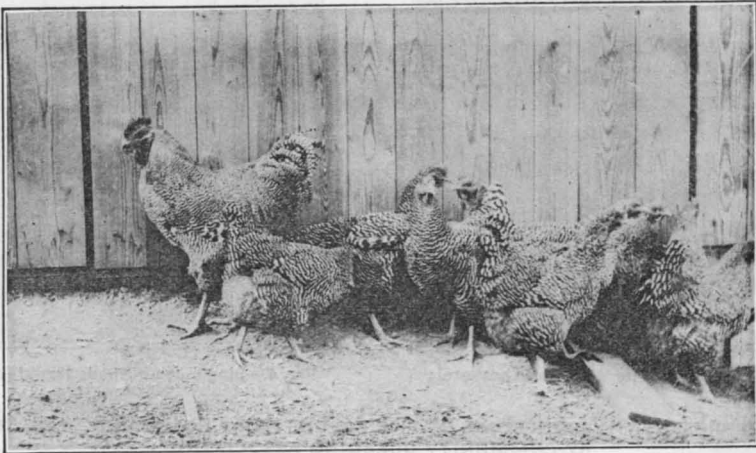

FIG. 2.—PEN OF BARRED PLYMOUTH ROCKS BELONGING TO MIDDLE-TOWN COMMUNITY BREEDING ASSOCIATION.

Christian County, which is probably the outstanding example of community breeding in that State, is now known as a White Wyandotte center. Each year its reputation in that respect is growing and becoming better established.

THE BREEDS COMMONLY SELECTED.

As a rule fowls of the general-purpose type are selected as the community breed. The choice rests with the members, most of whom are farmers who prefer a general-purpose farm fowl. There has been a noticeable preference for the Plymouth Rock, Wyandotte, and Rhode Island Red. On the other hand, some communities have selected one of the well-known egg breeds, and are producing white-shelled eggs to meet a special market demand. Franklin County, Va., for instance, has a White Leghorn association of 75 members, which sells eggs in New York. In 6 counties of Tennessee associations developed in a similar way also raise White Leghorns and ship the eggs to New York.

HOW COMMUNITY POULTRY ASSOCIATIONS ARE STARTED.

Poultry-breeding associations are usually the outgrowth of pioneer work in organizing boys and girls into poultry clubs or of repeated efforts to interest producers in better poultry methods. In some instances, however, leaders in communities have expressed their desire to make an effort to establish for themselves a business or side line that will add to their incomes as individuals and likewise increase the prosperity of the community.

In such promising localities, the first step in organization usually is to get the support of local business men. In small towns many business men own farms and consequently are interested in agriculture, which in turn benefits the various lines of business. At the same time their assistance is helpful in financing the association. In fact this is frequently accomplished by inducing the business men's association to contribute a suitable fund for standard-bred stock which is to be distributed among the farmers who join the association. Cooperation of that kind is usually obtained easily if the business men are shown the advantages of the organization

and how the increased prosperity eventually will benefit them.

Another plan that has proved to be satisfactory in Overton County, Tenn., is direct financial assistance from the banks. In this case the banks advanced \$1,000 to be invested in breeding pens through the cooperation of the poultry-club agent and the county agricultural agent. Each pen consisted of 10 hens or pullets and a male bird which cost on an average \$2.50 a bird. The pens were placed with club members in the various communities. Each person who received a pen guaranteed to return, after the first year, 20 fowls in payment for the original 10 hens or pullets furnished him. Those 20 standard-bred fowls, together with 2 selected male birds, were divided into two pens and the next year were given under the same conditions to two additional club members. One of the requirements of the plan was the continuance of this "endless-chain" system for 5 years, or until every member possessed at least one pen of standard-bred fowls. Thus the original pens have been multiplied by many hundreds, and the entire county has become well stocked with one breed of fowls.

In order that the loan made by the bank might be returned, together with a reasonable rate of interest, the club members agreed to dispose of their mongrel hens when they ceased to become productive, and to apply the money on the loan. They agreed also that additional money in excess of the original allotment of \$1,000 was to be deposited in the bank to further the club activities.

DISPOSAL OF MONGREL STOCK.

Since one of the principal purposes in creating community poultry-breeding centers is to dispose of all mongrel stock and to unify the breed of the standard-bred stock, several plans have been adopted whereby the mongrel stock may be disposed of promptly and without loss to the member. The first plan to be practiced successfully in several communities was to set aside a day advertised as "mongrel day," when all members of the association were requested to bring to a certain point all their mongrel poultry, to be sold at regular market quotations and shipped to the best market.



FIG. 1.—BOYS' AND GIRLS' RHODE ISLAND RED COMMUNITY ASSOCIATION, CHAMP, VA.

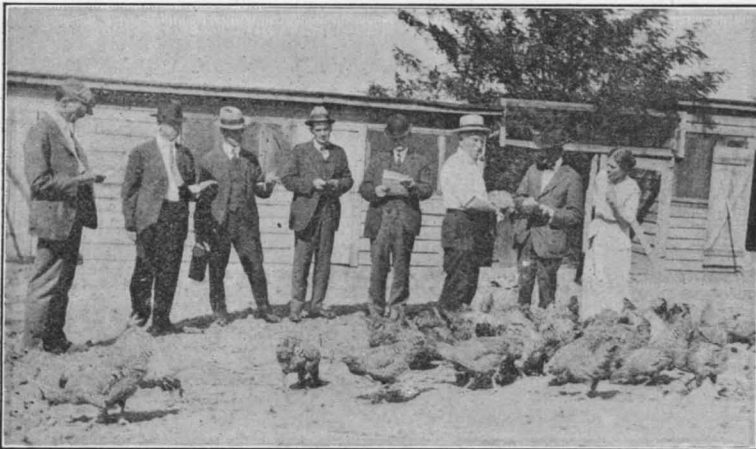

FIG. 2.—GOVERNMENT POULTRY ADVISER INSTRUCTING MEMBERS OF THE FARMVILLE BARRED PLYMOUTH ROCK ASSOCIATION IN THE USE OF MARKET-POULTRY SCORE CARD.

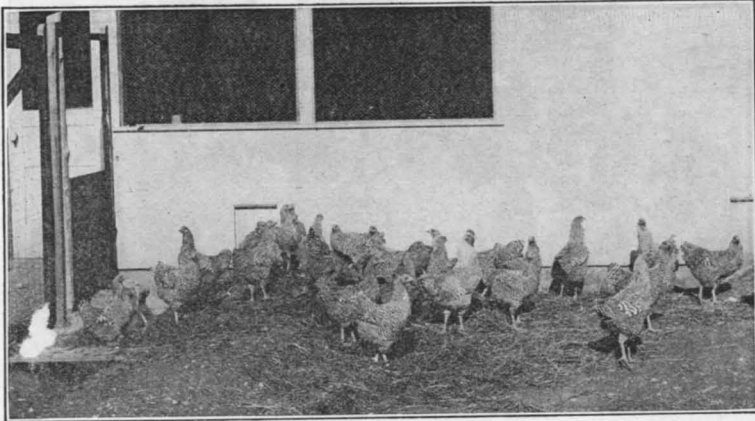

FIG. 1.—FLOCK OF STANDARD-BRED BARRED PLYMOUTH ROCKS.
Note uniformity, size, and color as contrasted with flock of mongrels shown in figure 2.



FIG. 2.—FLOCK OF MONGREL HENS.
Note how unattractive this flock is, compared with the flock of pure-bred Barred Plymouth Rocks shown above.

A plan of that kind makes it possible to eliminate a large number of mongrels in a short time and make room for standard-bred stock.

Sometimes members of the association may object to disposing of all their mongrels, especially their pullets and their hens that have not finished the second laying year. When that is the case, arrangements usually can be made whereby all mongrel cocks and cockerels are marketed, either by selling them at the regular market price or by getting the local poultry buyers to offer the member one standard-bred male bird of the community breed in exchange for two mongrels.

ADVANTAGES OF COMMUNITY MARKETING.

After the work is well under way and the association is in position to market its products, the association secretary or manager should make arrangements to find a good market for eggs, especially in case lots, also broilers, surplus fowls, and possibly capons, as in the case of the Farmville, Va., association. When the marketing is done as an association, little difficulty is experienced in obtaining satisfactory returns.

To take advantage of other sources of revenue, the association should advertise when it has breeding stock for sale. Advertisements should mention specifically that the association is in position to fill orders of considerable size, whether for hatching eggs, day-old chicks, or breeding stock. In time, if conditions warrant, the association members may consider the erection of a community hatchery similar to those in successful operation at Petaluma, Cal. This increases their incubator capacity, enables them to do custom hatching, and also affords the opportunity for selling day-old chicks.

If there is a creamery in the community, the association members have the possibility of fattening surplus fowls on skim milk or buttermilk as a supplement to other feeds. Fattening on such products is done on a large scale in the Middle West. In that way surplus stock can be marketed at an increased profit, together with such stock as may be purchased from neighboring farmers and poultrymen.

COMMUNITY POULTRY EXHIBITS.

A prominent event of the year for community breeding associations is the customary annual poultry show, usually a social as well as a business event. Fowls raised by the members of the association compete for prizes given by public-spirited individuals and local merchants. Such exhibits not only stimulate interest in the work as a whole, but create friendly competition among the members. In addition to various social features, an educational program is planned, in which talks are given by representatives of the State college of agriculture and prominent local people.

In order that a wide distribution of prizes and awards may be made in a large display of one breed or variety of fowls, the plan of classification necessarily should allow for this condition. If the community breed is such that the double-mating system is required to produce exhibition males and females, prizes should be offered for the first, second, third, fourth, and fifth best old and young individuals and pens of both matings, together with the exhibition individuals and pens. The double-mating system is now being used with some of the utility breeds, notably the Barred Plymouth Rock, and farmers interested in exhibition fowls, as at the Farmville, Va., community, soon come to understand its working.

When the community breed comes within the scope of the single-mating system, old and young pens and individuals should compete in separate classes and a wider range of placings be made. The usual number is five.

As a possibility for further development in community poultry exhibitions of that kind, the plan of offering prizes for the best eggs produced and best-dressed fowls shown should receive consideration, since the future success of the organization depends in a large measure upon the quality of both these products.

COMPOSITION AND FOOD VALUE OF BOTTLED SOFT DRINKS.

By J. W. SALE, *Assistant Chemist*, and W. W. SKINNER, *Chemist in Charge, Water Laboratory, Bureau of Chemistry.*

CONSUMPTION OF SOFT DRINKS IN RURAL COMMUNITIES.

NEARLY all general stores at crossroads and in small villages in the United States carry regularly a stock of bottled soft drinks, frequently designated simply as "sodas." The consumption of these products increases each year, and with the growth of prohibition, it seems probable that their manufacture and distribution will assume very large proportions. In fact, it has been estimated that during the few years just prior to the curtailment of the industry due to war conditions, the sale of soft drinks in the United States amounted annually to over three billion bottles. It is interesting to note that along with rural free delivery, the telephone, individual electric-light plants, and electrical appliances, the dweller in a rural community is able to purchase at the nearest general store a product which a few years ago was obtainable only at soda fountains in towns and cities.

Bottled soft drinks are consumed chiefly for the delectation of the palate and for quenching thirst. The fact that they have some food value is usually not given consideration. In the past the average consumer has known little of the composition of these beverages, and since there are all sorts of bottled soft drinks, good, bad, and indifferent, he has not been in a position to demand a high-grade product. That there is a growing discrimination on the part of the public consuming these products is evidenced in the great improvement in the quality and purity of many of them. It is the purpose of this article to describe briefly the ingredients of some of the standard types of bottled soft drinks, in order that the purchaser may be more critical in his selection, thereby raising still further the standards of some of the manufacturers of these food products.

COMPOSITION OF SOFT DRINKS.

All bottled soft drinks contain water, flavor, sweetening, and carbon dioxid gas. Some contain also one or more of the following ingredients: Color, such as caramel or burnt sugar; acid, usually citric found in lemons, or tartaric found in grapes; and a condiment, such as capsicum or red pepper, cinnamon, allspice, cloves, or nutmeg.

FLAVORS.

The flavors for soft drinks include ginger ale, sarsaparilla, root beer, birch beer, chocolate, cream, colas, cherry, wild cherry, lemon, strawberry, raspberry, orange, pineapple, grape, loganberry, apple, pear, peach, and others less widely distributed. These flavors are of two general types, those which are obtained from natural products, such as the root, bark, leaf, and fruit of plants or trees, and those made in the laboratory by synthesizing or combining two or more chemicals. Examples of the first type, which may be called natural flavors, are ginger extract and ginger oleo-resin, which are obtained from ginger root by maceration and extraction with a solvent such as alcohol, ether, or acetone; lemon oil, obtained by expressing the rind of the lemon; and fruit juices. The demand for the true fruit flavors is increasing, and each year larger quantities of grapes, strawberries, raspberries, etc., are used to supply the soft-drink industry.

The department encourages the use of fruits in the manufacture of bottled beverages, for the reason that grapes, strawberries, raspberries, etc., are highly perishable foods and their use in the form of bottled beverages offers an additional means of conservation of these valuable products, especially the surplus. Of course, large quantities of these fruits are preserved for future use by being canned. If, however, it is possible to develop an additional outlet for utilizing them on an extensive scale, as in the manufacture of bottled soft drinks, the fruit-growing industry will be materially benefited. An interesting example of a recent development in the use of fruit for bottled beverages is the loganberry, which is now quite extensively sold. Grape juice

is a well-known article, but it is believed that there is an opportunity for a further development of a grape extract for use in bottled sodas. When fruits like the strawberry, raspberry, and grapefruit are crushed and the juice expressed, the product obtained is cloudy, due to the presence of very finely divided portions of the fruit cells. If the juice so obtained is clarified by filtration or by treatment with a clarifying agent, such as kaolin, followed by filtration, the quality and intensity of the characteristic flavor of the fruit usually will be found to have been greatly diminished. One reason for the great development of artificially flavored beverages is the difficulty of producing satisfactorily from fruits a clear, transparent beverage that will remain clear and free from sediment upon storage. It is unfortunate that the public has been educated to consider clearness and transparency of bottled beverages as measures of quality, since the turbidity is often an evidence of a true fruit product of superior quality. Beverages made with artificial flavors must be labeled to show they are so made when the product is sold in interstate commerce, thus becoming subject to the provisions of the Federal food and drugs act.

The second type, artificial flavors, is represented chiefly by the products which simulate the odor of cherry, grape, raspberry, strawberry, peach, pear, etc. The chemical composition of these flavors differs from that of the natural products, and they are characterized by a decided ethereal odor, but are deficient in taste.

Vanilla differs from both of these types in that vanillin, which is one of the ingredients of the vanilla extract as obtained from the vanilla bean, can be synthesized or manufactured. The artificial vanillin is used very largely in the manufacture of cream sodas. The Federal food and drugs act requires that beverages made with artificial flavors must be so labeled.

Usually two or more flavors are combined to give the desired bouquet. For example, ginger ale frequently contains lime juice or oil of limes, orange, etc., in addition to extract of ginger.

The flavoring ingredients used in soft drinks are but slightly soluble in water, but easily soluble in alcohol.

Moreover, the water solution of most of the extracts readily deteriorates. Consequently, the extracts employed by the bottler are similar to the concentrated extracts used in cooking, and contain a rather high percentage of alcohol. However, but a very small quantity of extract is contained in the finished beverage, the percentage of alcohol present being proportionally small. Usually, it amounts to only a few tenths of 1 per cent by volume.

SWEETENING.

Prior to the war almost all of the sweetening in soft drinks was ordinary white granulated sugar. As increased demands were made on the sugar supply, bottlers turned for relief to so-called sugar substitutes, such as corn sirup or glucose, corn sugar or commercial dextrose, maltose sirup, refiners' sirup, and honey. The department encouraged the use of these substitutes for sugar as a war measure, and it has been estimated that at least 50,000 tons of sugar annually could thus be saved without materially lessening the food value of these beverages. It is probable that some of these sugar substitutes in combination with sugar will be used regularly in certain types of soft drinks, especially root beer, sarsaparilla, and similar heavy-flavored beverages, since an increased "body" with less sweetness is desirable in many of these beverages. The Federal food and drugs act requires that when sweetening ingredients other than ordinary sugar are used in soft drinks, their presence should be plainly stated on the label.

Because of their content of sweetening, high-grade beverages have a greater food value than most people realize. Such products as ginger ale, the phosphate drinks, lemon sours, and grape soda contain from three-fourths to one and one-half ounces of sugar per half-pint bottle, while sarsaparilla, root beer, etc., contain from one-half to three-fourths ounce of sugar per half-pint bottle. Thus, an 8-ounce bottle of a sweet ginger ale contains 1 ounce of sugar, which is approximately twice the sugar ration per meal under war conditions, when the amount was restricted to 3 pounds of sugar for 90 meals. When glucose, honey, etc., replace part of the sugar, relatively larger proportions are

used to obtain the desired degree of sweetness, and the food value of the beverage is increased proportionally.

As a rule, children prefer sweeter soft drinks than the adult consumer of these products. Too much sweetening tends to mask the delicate flavors of ginger ale, lemon sour, etc., and, therefore, is not favored by those with a discriminating taste. Herein lies the advantage of the sugar substitutes. Larger quantities can be used, thus securing the "body," a most desirable quality, without making the product distastefully sweet. At the same time, the food value of the beverage is maintained or increased.

CARBON DIOXID GAS.

Most bottled soft drinks are effervescent—that is, when first uncapped, the liquid bubbles and froths. This property is due to the impregnation under pressure or at reduced temperature of the mixture of water, sirup, flavor, etc., with carbon dioxid gas. Carbon dioxid is obtained in various ways, such as burning coke or limestone, and by the action of an acid on a carbonate such as soda ash. Contrary to a belief more or less prevalent, the raw products used in the manufacture of carbon dioxid—that is, the coke, limestone, acid, or soda ash—are not present in the bottled beverage. Only the gas itself is used, and this gas in bottled soda water is a wholesome product, identical with the carbon dioxid which occurs naturally in large quantities in certain mineral springs in the United States. Springs of this type are highly prized for their effervescent properties, and at some the escaping gas is collected, compressed, and used for carbonating soft drinks and mineral waters. The carbon dioxid, from whatever source obtained, is purified, and usually converted into a liquid by means of increased pressure and decreased temperature. It is then placed in stout steel cylinders and shipped to the bottler. When the stop cock on the steel cylinder is opened, the gas is evolved, being converted from a liquid to a gaseous state by the release of pressure. The gaseous pressure in bottled soft drinks usually varies from 40 to 80 pounds per square inch.

COLOR.

Nearly all bottled soft drinks are colored artificially. Ginger ale, sarsaparilla, root beer, birch beer, chocolate, and

colas ordinarily are colored with caramel, which is made by carefully heating sugar or glucose. As a rule vanilla, or as it is frequently called cream or club soda, is uncolored. The other drinks are generally colored with one of the permitted dyes. Naphthol yellow or tartrazine, which gives a yellow color, is ordinarily used in lemon sour; amaranth, ponceau, or erythrosine, in cherry, strawberry, raspberry, etc. Certain dyes, such as those already mentioned, may be used in food which is shipped in interstate commerce, provided they do not conceal inferiority and their presence is plainly declared on the label of the product.

ACID.

Many soft drinks, like ginger ale, the colas, cherry, lemon, strawberry, raspberry, orange, pineapple, grape, and phosphate, contain the fruit acids, citric or tartaric. The mineral acids are also used, phosphoric frequently, and sulphuric and hydrochloric acids to a smaller extent. Certain beverages, however, such as sarsaparilla, root beer, birch beer, chocolate, and vanilla, contain no acid, and are classified as belonging to the nonacid group of soft drinks. The fruit acids, citric and tartaric, occur naturally in various fruits, imparting to them their tartness. It is considered permissible to add pure fruit acids to beverages, thus simulating the fruit after which the beverage is named. Sulphuric and hydrochloric acids, however, do not occur naturally in fruits or fruit juices, and, in the opinion of the writers, they should not be used to contribute tartness or sourness to soft drinks. The quantity of citric acid added depends upon the flavor, and the quantity of sugar used, but is approximately from one to three grains to the half-pint bottle.

By increasing the amount of acid added, the quantity of sugar can be increased, thus imparting "body" or viscosity to the beverage without increasing the apparent sweetness.

CONDIMENTS.

One of the chief condiments added to soft drinks is capsicum or red pepper, a minute quantity of which is added to ginger ale to increase its pungency. In the process of rendering ginger extract soluble in water or sugar solution,

much of the natural heat of the ginger is lost; consequently, it is customary to reinforce the ginger extract with an extract of capsicum or of some other member of the pepper family. Some ginger ale, however, has no added capsicum, the process of manufacture being such that more of the natural heat is retained, or the natural ginger flavor is reinforced by supplementary flavors. Other condiments sometimes used in ginger ale are nutmeg, cinnamon, cloves, allspice, etc. In like manner, such beverages as sarsaparilla may contain various kinds of spices or condiments designed to render them appetizing.

BOTTLING SOFT DRINKS.

Where soft drinks are bottled on a large scale, the sanitary precautions taken are usually excellent. This is especially the case where beverages are aged—that is, manufactured and stored to develop and improve quality. When this procedure is carried out, it is essential that the product be bottled in a clean manner; otherwise, a loss, due to spoilage, occurs through the development of “flat sours,” “ropiness,” “sediment,” etc.

Where soft drinks are manufactured in a small way for immediate consumption, however, the sanitary conditions are not always the best, and in some cases they are deplorably filthy. The sirup and filling rooms may easily become dirty from the spilling of sirup and extracts, which attract flies and other insects. Proper precautions in washing bottles are not always taken, nor is the water used for preparing the sirups and for filling the bottles always pure. Modern machinery for preparing food products of this sort for the market has been perfected to such an extent that there is little excuse for offering for sale an insanitary article. A belief is more or less current that carbon dioxid gas preserves bottled soft drinks from fermenting and souring. While this is to a certain extent true, carbon dioxid can not be depended upon to overcome or neutralize insanitary conditions in the bottling house. The sanitary quality of bottled soft drinks shipped in interstate commerce is subject to regulation under the Federal food and drugs act.

SUMMARY.

High-grade bottled soft drinks enable the dweller in rural communities to enjoy a food product which a few years ago was obtainable only in towns and cities, directly from soda fountains.

Flavors and condiments, well-known household articles, are used in soft drinks, and are of a varied nature designed to make the product attractive to the taste.

In addition to being delectable, soft drinks have food value, due sometimes to their content of sweetening ingredient, which amounts to from 5 to 12 per cent of the total weight of the beverage, and, in some cases, to the fruit extracts which they contain.

The quality of bottled soft drinks depends largely upon the demand made by discriminating consumers. Some knowledge of the composition and preparation of these products for the market, as set forth in this article, should enable the average consumer to ask for only high-grade beverages.

The annual consumption of bottled soft drinks in the United States prior to war restrictions in production is estimated as about three billion bottles.

It is estimated that over 10,000 establishments, employing about 75,000 people, are engaged in the bottling of soft drinks in the United States.

THE OLD AND THE NEW IN CORN CULTURE.

By H. HOWARD BIGGAR,

Office of Corn Investigations, Bureau of Plant Industry.

CORN THE GREAT AMERICAN CEREAL.

CORN, the greatest of American cereals, is distinctively an American product. All evidence points to the fact that it was unknown in Europe until after the discovery of America. Its culture at an early period in this country is shown by the accounts of early explorers. Columbus, in writing to King Ferdinand and Queen Isabella in 1498, mentions cornfields in America 18 miles in length. Cartier, in the account of his explorations, states that the village of Hochelega, which later (in 1535) became Montreal, was situated in the midst of large cornfields. De Soto found large fields in Florida in 1675, and five years later La Salle noted large supplies in what is now the State of Illinois. That it was grown rather extensively is also indicated by the fact that in 1685 1,200,000 acres of corn belonging to the Seneca Indians were destroyed by the English in New York. In 1696 Frontenac, who invaded the Onondaga country in New York State, spent three days in destroying growing fields.

CORN AND THE EARLY COLONIES.

The value of corn to the early colonists of the United States can hardly be overestimated. The Indians, through many years of experience, had learned the kinds of corn best suited to withstand varying conditions, and also some successful methods of corn culture. These facts were communicated to the colonists, who soon began growing corn. Corn was preferred to other cereal crops because it was easily cultivated, brought large returns in proportion to the amount of seed planted, and was an ideal feed for the production of hogs and cattle. Every man of John Smith's colony was given an acre of land and instructed to plant corn on it. Corn soon became a medium of exchange among the colonists. Taxes, rents, and debts were paid in corn, and

it was even bartered for marriage licenses. It is certain that on many occasions starvation would have overtaken the colonists had it not been for supplies of maize.

CORN AND THE INDIAN.

Upon the Indian, the first grower of corn, the cultivation of maize has exerted a more or less striking influence. Its cultivation in large fields made necessary a banding together of the individuals of the tribes. It was a sort of community or cooperative undertaking. With the cultivation of maize, the Indian brought northward the art of pottery making. Schoolcraft, the historian, states that mound building is associated with the growing of corn, being made necessary as a means of defense and easily accomplished because of the communal method of living.

The development of corn growing among the Indians encouraged the trading spirit. The corn of the Huron Indians in New York was exchanged for furs and other commodities. The agricultural Indian tribes of the Missouri Valley in North Dakota early developed a trade in corn and vegetables with the white traders and explorers, thus enabling the latter better to carry on their operations. They also traded with the hunting tribes of the Plains, securing furs, horses, and weapons, thus enabling them better to withstand invasion from powerful enemies. To the Plains hunters, the securing of corn meant prevention of famine in seasons when the hunting was poor. The trading equivalent of corn in the early days indicates its importance in the opinion of the Indian. Buffalo Bird Woman, a Gros Ventre of the Fort Berthold Reservation, states that a buffalo robe used to be given in exchange for a braid of corn containing about 50 ears. Red Bear, an Arikara of the same reservation, states that the Sioux Indians used to give his people a horse in exchange for 10 braids of corn.

The presentation of corn as a gift to other tribes and to the whites was common. It was the sign of friendship. Verendrye, in 1738, was met near the Mandan village, in what is now North Dakota, by a messenger who presented him with corn. Lewis and Clark, who wintered near this village, Maximillian and Verendrye, as well as other white

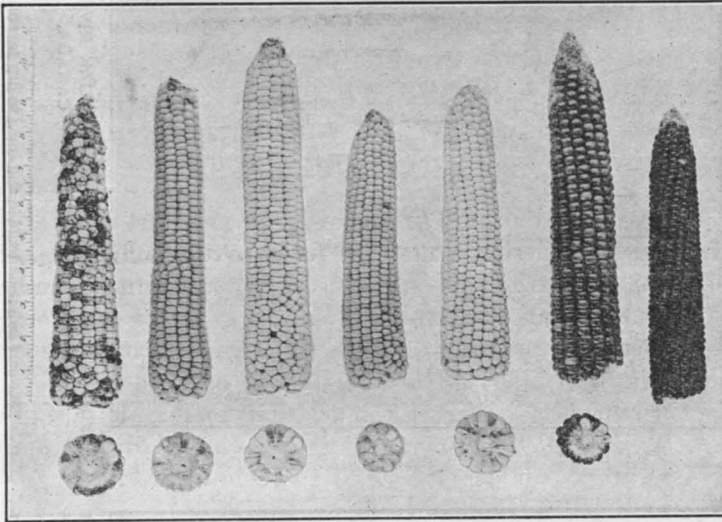

FIG. 1.—TYPES OF CORN RAISED BY THE INDIANS OF THE SOUTHWEST. From left to right: Navajo birdsegg, Navajo yellow, Navajo white, Hopi yellow, Hopi white, Hopi blue, Hopi black.

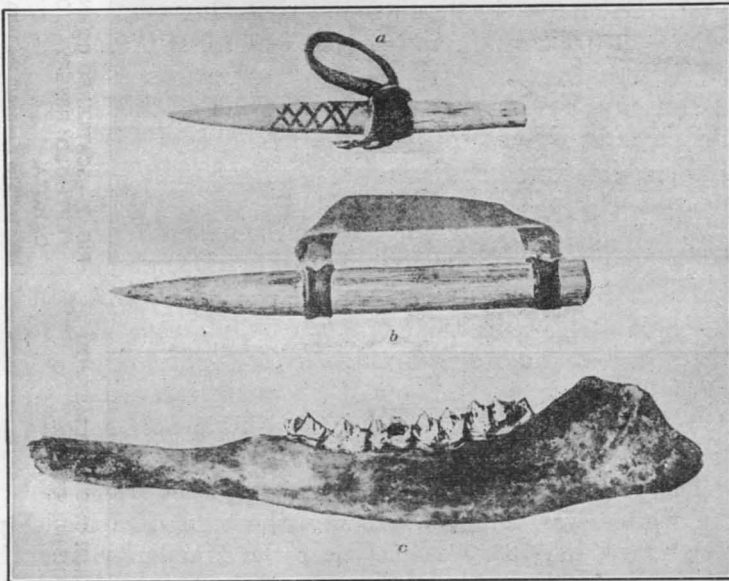

FIG. 2.—CORN HUSKING AND SCRAPING TOOLS.

(a) An Indian's corn-husking pin made of bear bone. (b) A white man's imitation of the above. (c) A scraper made from a deer's jaw and used by the Iroquois Indians for removing green corn from the cob. (Courtesy of the Canada Geological Survey.)



FIG. 1.—HOPI INDIAN SHOWING METHOD OF PLANTING CORN.

Holes 10 inches or more deep are dug to reach moisture, and then 15 or more kernels are planted.



FIG. 2.—SCATTERED CORN OF THE FORT BERTHOLD RESERVATION IN NORTH DAKOTA.

She is "The Keeper of the Corn" for the Mandan Indians and is responsible for keeping a reserve seed supply.



FIG. 3.—SIOUX INDIANS OF THE OAK RIVER RESERVATION, MANITOBA, CANADA.

The ears had been braided and hung to dry several days previous to being photographed on August 30, 1916.

traders and explorers, probably would have found it impossible to carry on their operations without the food (principally corn) obtained from the village Indians of the upper Missouri Valley.

Corn came to us as a gift from the Indians. Doubtless no other word in the Indian vocabulary is so important to the Indian, since for generations corn was the main food plant. The Indian's regard for corn is really a veneration. In the Middle West, the Corn Priest proclaimed the time to plant and to harvest the fields of corn and from time to time prayed that the crop might be a productive one. In the Southwest, corn shrines, corn dances, and numerous corn ceremonies are evidence of the regard of the Navajo, the Hopi, and the Zuni for their favorite cereal.

A study of the methods of corn culture of the various Indian tribes is of interest as showing the beginnings of what are now widely adopted practices. It also affords us an idea of primitive adaptation to conditions.

KINDS OF CORN GROWN BY THE INDIANS.

The Indians grew two main types of corn, *Zea mays indurata*, or the the flint corns, and *Zea mays amylacea*, or the flour corns. Inasmuch as corn was mainly used for human food, each type had its particular use. Flint corn was raised mainly for the making of hominy. Flour corn, because of its soft, starchy composition, was very easily ground in mortars. It was, therefore, especially valuable for parching and making into soups, puddings, and corn bread.

A distinguishing feature of the primitive Indian corns was their various colors. Among the kinds of corn grown were the following: Red-streaked flour, pink flour, white flour, red flour, blue flour, spotted flour, yellow flour, salmon-colored flour, white flour with kernels tipped with black, white flint, yellow flint, and pink flint. It must not be understood that all of these various kinds have passed out of cultivation. On the contrary, practically all of them can still be found, having been planted in small quantities from year to year, even up to the present time. An endeavor was made to keep the various kinds separated by planting in fields apart from each other.

PRIMITIVE SEED-TESTING METHODS.

Various methods of testing the germination of seed corn were practiced by the Indian tribes. On the Red Lake Reservation in northern Minnesota, corn was grown along the borders of Red Lake. The locality is more or less densely wooded; hence, use was made of moss in germinating seed previous to planting. A box was filled with moss, and kernels of corn were placed in the moss. The whole was soaked in water for a time and then set in a warm place until the kernels sprouted. Dead kernels were discarded, and the sprouted kernels were planted. Other tribes made willow baskets, filled them with kernels of corn, poured water through the corn, and placed the baskets in a warm place to start germination. Among the northern and western tribes, it seems to have been a general custom to soak the kernels of corn previous to planting, the object being to hasten the germination of the seed.

In connection with the soaking of the kernels, superstition played a conspicuous part. The older women of the tribes placed various substances in the water in which the corn was soaked. These substances were believed to influence the behavior of the future plant in the field and to insure its being free from plant diseases and other enemies. As an example of this might be cited the use of the ground plum (*Astragalus caryocarpus*). The fruits of this plant were often soaked in water with the corn. The ground plum is prolific, bearing many fruits, and it was the belief that its use in this connection would insure prolific corn crops.

THE NETTLE SEED TESTER.

It may be a surprise to many to know that a method of germination somewhat similar to our modern rag-doll seed germinator was used by middle-western tribes. The material used in this tester was the stem of the slender nettle (*Urtica gracilis*). It was used in the following manner:

When the time for planting corn was at hand, quantities of the nettle were gathered. They were piled in a sort of mat, and on this mat the kernels were placed. The mat of nettles was then rolled up so that it made a cylindrical

bundle, with the corn kernels on the inside. The bundle was tied around with strings cut from buffalo hide and then immersed in water. After soaking for a day or two, the bundle of nettles was wrapped in a buffalo skin or other covering and kept warm. In a few days the kernels sprouted, and when the sprouts were a quarter of an inch or more long they were planted. Kernels not sprouting or showing swollen germs were not planted.

The slender nettle was used for this purpose because it was the first plant to reach any considerable height by corn-planting time. Furthermore, the fact that the plant was protected by stinging hairs, or spines, gave the Indians the idea that corn germinated with it would be protected from plant enemies during the growing season.

PRIMITIVE CORN-PLANTING METHODS.

Location and climatic differences are no doubt responsible for the fact that three distinct planting methods were in vogue among the Indians. These were as follows: (1) The Hopi method; (2) the Omaha, or mound, method; and (3) the usual "hill" method.

The Hopi and other tribes of the Southwest, in order to reach moist soil in the sandy areas which they cultivate, make use of the planting stick in planting. This stick is about 3 feet in length and has a stiltlike projection about 10 or 12 inches from the bottom. The stick is pressed into the soil with the foot, and holes are made from 8 to 12 inches in depth. Into these holes as many as 20 kernels are dropped. The hills are about 10 feet apart. The number of plants in the hill may seem excessive, but none are thinned out, being left as a protection against wind and sun.

The Omaha, or mound, method was used by the Omaha Indians of Nebraska. In this method the earth was pulverized and heaped into mounds about 18 by 24 inches in area. The northern end of the mound was 18 inches in height, sloping to the south, the south end being level with the ground. The mounds were from 2 to 3 feet apart on all sides, and 7 kernels to the mound were planted. Sometimes a ditch was dug around the mound, into which water was poured in dry seasons.

INDIAN CORNFIELDS.

The "hill" method of planting was the one usually followed by most of the tribes. Ground was selected as a rule along the banks of streams, trees were cut down and removed, weeds and rubbish were cleared away. Land where weeds grew was preferred because it was the easiest to prepare and was thought to be the most fertile. The fields were apt to be more or less irregular in shape, owing to the fact that they usually followed the bends of streams.

In preparing land for corn, the entire field was not dug up and pulverized, but only space enough for each hill. Each spring the stalks were removed from the hill, it was pulverized and again used for planting, so that the same hills used over and over became quite large and distinctive, marking in after years the location of former fields. Even the Indian understood the value of spacing hills and they were usually 2 to 5 feet apart.

Since the Indians practiced cooperation in their agricultural work to quite an extent, large fields of corn were really made up of hundreds of individual fields. Families helped each other at planting time and harvest in many instances, and at such times the fields presented a busy appearance. In the upper Missouri River valley in North Dakota as recently as 30 years ago, the Mandan, Arikara, and Gros Ventre tribes cultivated a tract of about 1,200 acres not far from the river banks. During the months of May and June this tract must have been an interesting place to visit. Here swarthy squaws toiled long hours in the hot sun, working with primitive tools, the small fields being separated from each other in much the same way that children's school gardens are to-day. At the outskirts of the fields Indian sentinels might have been seen guarding the workers from the attacks of hostile tribes. Later on, in the fall of the year, a procession of toilers wended their way from the fields with braids of corn, carrying them to the village for storage.

PRIMITIVE TOOLS.

A more or less gradual evolution in the kinds of tools used in corn culture has taken place. The most primitive tool was the sharpened hardwood stick. Later, the shoulder blades of the buffalo and deer, deer antlers, and clam and

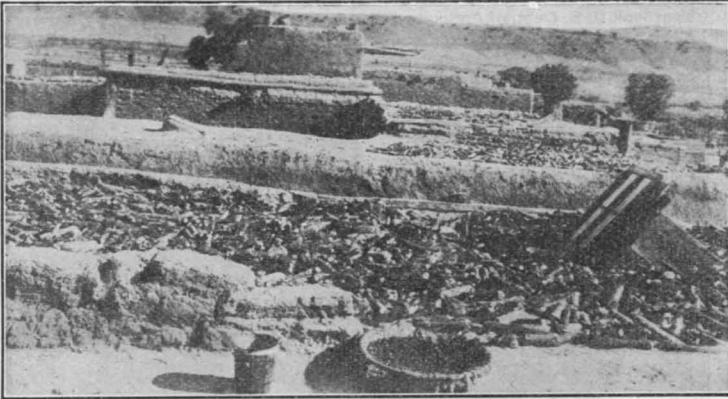

FIG. 1.—PUEBLO METHOD OF DRYING CORN ON THE ROOFS, AT SAN FELIPE, N. MEX.

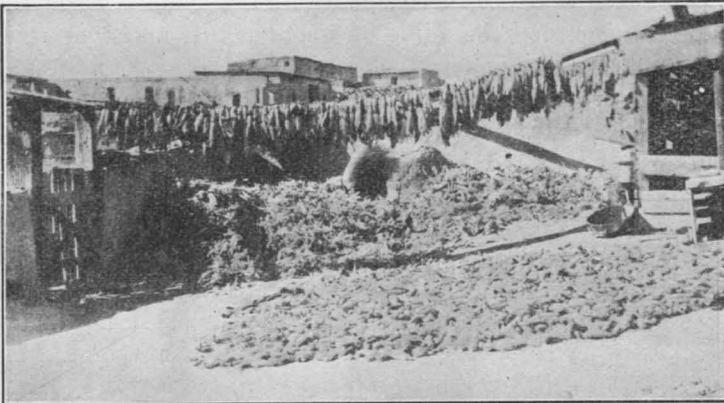

FIG. 2.—CORN DRYING IN A YARD AT LAGUNA, N. MEX.

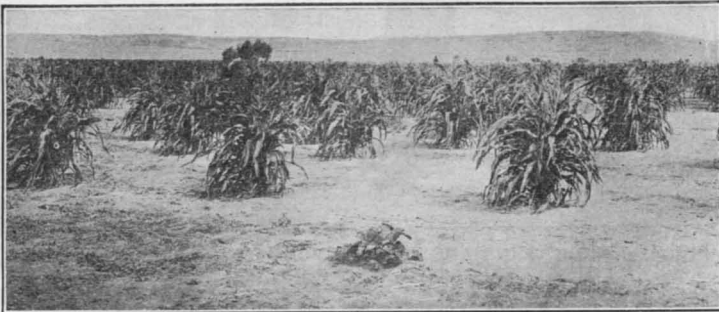

FIG. 3.—AN INDIAN CORNFIELD IN NEW MEXICO.

The hills are far apart, and the large number of plants in a hill afford protection from wind and sun.

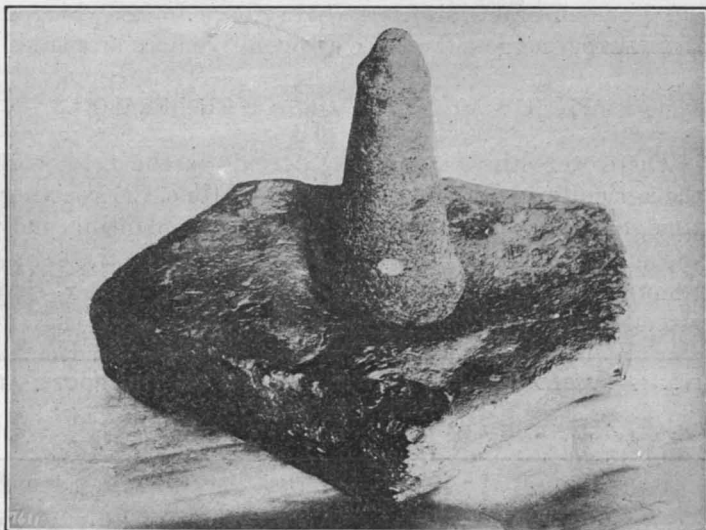

FIG. 1.—STONE MORTAR AND PESTLE USED BY THE INDIANS OF THE MIDDLE WEST FOR GRINDING CORN.

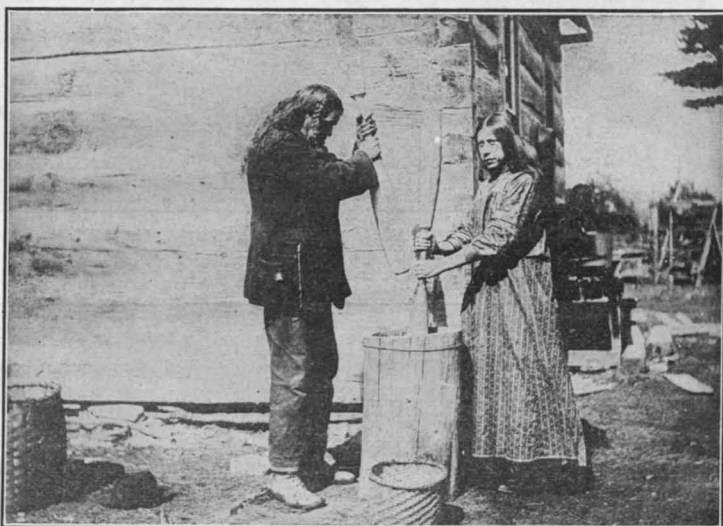

FIG. 2.—IROQUOIS INDIANS USING A WOODEN MORTAR AND PESTLE TO GRIND CORN.

Courtesy of the Canada Geological Survey.

tortoise shells were used. In the Mississippi Valley, numerous stone and flint implements have been found which, from their shape, suggest their use as primitive hoes or spades.

PLANTS AS INDICATORS OF THE SEASON.

There were three important periods in the field work of the agricultural Indians: (1) Planting time, (2) roasting-ear time, and (3) the harvest period. After planting, most of the members of the tribes left for other locations for the summer hunt. Usually, some of the women were left to attend to the weeding out of the patches. At roasting-ear time, many returned from the hunt to gather corn and prepare it for food, much of it being parched and put away for future use. When the ears were ripe, both men and women joined in the harvest.

It is of interest to note that the time to return from the hunt to gather the roasting ears and the ripe ears was indicated to the hunters by the appearance of prairie flowers the Indians having learned the relations between the growth stages of corn and other plants. One of these indicator plants was the blazing star, or buttonweed, whose habitat includes the States of the Middle West. According to an informant of the Omaha tribe in Nebraska, this plant was used as follows: When the Indians on their hunting trips saw the first small flower buds appearing on the blazing star, they knew that the corn in their fields at home was approaching the milk stage. When the buds were entirely open, the corn was ready for parching and it was time to return. Later in the season, when the plant was through blossoming, they knew that the corn was ripe and it was time to harvest. Other plants used as indicator plants on the Plains were the cat-tail and the goldenrod.

SEED SELECTION AND STORING.

The Indians practiced seed selection and had definite standards. Many tribes discarded the butts and tips, planting only the middle portions of the ears. Some tribes discarded ears with moldy cobs or with irregular rows. Well-filled ears were preferred, with straight rows of kernels.

Seed ears were selected each fall and the husks braided together, so that a braid would contain about 50 ears and would be about 5 feet long. Practically all the Indian tribes seem to have practiced braiding. The tribes of the Southwest hung the braids up to dry or else spread unbraided ears on the ground or on the roofs of their flat-topped houses. After the drying was completed, the corn was stored in the lower stories of the dwellings. Some of the southwestern tribes used large storage baskets.

The Indians of the New England and Middle-Western States used the cache for storing corn and other foodstuffs. These caches were holes dug in the ground, usually to a depth of 5 to 7 feet and several feet in diameter. They were either jug-shaped or cylindrical. Although the fields of corn were usually on the lower lands, the caches were dug on the higher ground so as to avoid danger from seepage waters. Caches were dug either inside or outside of the dwellings. Considering the rude tools at the disposal of the Indians, the digging of a cache was no small task.

Shelled corn and braided corn were both put in the caches. Usually the shelled corn was placed in buffalo or deer-skin sacks before caching. Indians in the forest country cached their corn after placing it in bags made of cedar bark. A fire was often started in the cache after completion, in order to dry it out before storing corn. Grass and bark were used in lining the sides and bottoms. The final covering was earth, and when well covered the cache could not be distinguished by strangers, and so was not in much danger of being robbed. Sometimes one family had as many as two or three caches.

INDIAN CORN FOODS.

The colonists obtained their first knowledge of how to use corn as a food from the New England Indian tribes. Capt. John Smith, in his accounts, mentions the preparation of several corn foods. The Iroquois Indians had at least 40 different ways of cooking corn. The "travelling food" of this tribe is an interesting example, as showing Indian food combinations. Soft or flour corn was used. It was shelled and parched slightly in the embers of a wood fire. Then it was thrown into a mortar, maple sugar was added, and it was

pounded and sifted until it was a very fine meal. Sometimes dried fruits, such as cherries, were pulverized with it. The food was carried on hunting expeditions and in time of war. One-fourth of a pound, diluted in a pint of water, was a good dinner.

Succotash was a dish prepared by New England and middle-western tribes. Corn was cut from the cob, placed in a kettle with a quantity of beans, and then boiled. Salt and butter were added as seasoning.

According to Dr. Walter Hough, of the National Museum, the Hopis had 52 kinds of corn foods. One of the main ones was prepared as follows: Large pits were dug in the sand. They were heated with burning brush, filled with roasting ears, and tightly closed for a day. When the pit was opened, corn feasts were held.

Hominy was a food used by most of the northern and middle-western tribes. Wood ashes were used to make lye water for removing the hulls. Flint corn kernels were placed in the water with the wood ashes. The water was boiled until the hulls were removed. The hulled corn was then rinsed off, put into another kettle with clear water, and boiled.

A food of the Gros Ventre Indians, called "husared," was prepared by grinding corn and placing it in corn husks. The husks were folded over with the corn on the inside, tied up, and then dipped into boiling water.

Corn smut (*Ustilago zea*) was often used as a food by some tribes. The Gros Ventre tribe gathered the smut, boiled it, dried it, broke it into bits, and ate it with corn as a relish. It is said to have tasted like corn and was very palatable.

PRIMITIVE AND MODERN METHODS OF CULTURE.

The evolution in methods of corn culture since the primitive days when the Indians cared for their main food plant may seem very striking. In comparing, however, the practices of the red man with our modern methods of corn culture, we must not fail to recognize his ingenuity and foresight. Modern tools were not available. Years of experimental evidence as to the wisdom of this or that step were wholly lacking. In view of these facts, the Indian's utilization of materials at hand and his methods of procedure

are to be commended. The Indian had no means of recording time. He watched the forces of nature in planning his agricultural work. Seed was prepared and corn was planted when the wild turnips began to bloom, when grass became green, when plums, wild grapes, or juneberries began to blossom, or when the leaves of the trees began to uncurl.

In lieu of our modern tillage machines, the squaws of the tribes worked up the ground with tools wrought from wood, bone, or stone. The number of kernels planted per hill has not materially changed even to this day. The principle of spacing hills and the distance apart of hills are about the same to-day as in primitive times. Special attention was given to the type of seed ear, the drying of seed, and the testing of germination in primitive testers; all these indicate an almost uncanny knowledge on the part of the Indian agriculturist, quite in keeping with our emphasis on these points to-day.

It is a far cry from the cache to the modern well-ventilated corn crib, but the utility of the cache as a burglar-proof storage house can not be denied. Domestic-science experts, skilled in methods of utilization of corn as a food, must not fail to recognize primitive housekeeping skill as exemplified in the scores of corn foods prepared and used by the Indians.

CORN AND THE WESTWARD MOVEMENT.

The story of Indian corn is the story of the struggle of the human race for food in the Western Hemisphere. It is the story of definite rotations where corn is the cultivated crop. The dependence of the Indian upon corn, how it called into play his inventive genius, and its adoption as a crop and a food by the early colonists have been mentioned. Its popularity among the colonists resulted at last in a corn surplus, which was sent to the West Indies and South America in exchange for products of those countries.

A steady influx of population along the Atlantic coast made more agricultural land necessary. The westward movement began, and settlements were made beyond the Alleghenies, where much of the soil was found to be especially suitable for corn production. The feeding of live stock began, and the surplus corn crop from west of the Alleghenies

moved to the East in the shape of cattle and hogs. It was a not uncommon sight to see large droves of cattle and hogs being driven across the mountains from the Ohio Valley to Baltimore. Increasing trade with the eastern part of the United States and the beginnings of European trade made systems of transportation necessary. National highways were opened, canals were constructed, and at last railroads linked widely separated territory, so that the products of the West could reach quickly the eastern cities, the Atlantic seaboard, and the Orient.

The progress of invention and commerce was hastened by rapidly increasing supplies of corn and corn-fed animals.

CORN AND THE PACKING INDUSTRY.

The increasing production of corn and the consequent increase in hogs and cattle developed the packing-house industry. About 1832 the city of Cincinnati was nicknamed "Porkopolis" because of its importance as a pork-packing center. The Union Stock Yard and Transit Co. of Chicago began its operations in 1865. For a number of years it remained the only large market. In 1871, 1874, 1877, 1884, and 1898, stockyards were established at Kansas City, St. Louis, Sioux City, South Omaha, and St. Joseph. The growth of the packing industry has been indeed rapid. According to the Interstate Commerce Commission reports, there is a steady growth in the tonnage of packing-house products carried by the railways in the United States. For the years 1914, 1915, and 1916, the report of tonnage is as follows:

	Tons.
1914 -----	5, 739, 000
1915 -----	6, 193, 623
1916 -----	6, 831, 801

The increasing utilization of by-products of the packing houses is more or less familiar to all of us. As for the movement of live stock from the farms to various markets, live stock whose ration to a greater or less extent is corn, figures are so large as to be almost incomprehensible. According to the Bureau of Markets of the Department of Agriculture, the receipts of hogs during the 5 years from 1913 to 1917 at 12 leading markets averaged over 26,000,000 animals annually. The increase in receipts for this period over the

previous 5 years is 14 per cent. In the year 1917 these same 12 markets received more than 14,000,000 cattle.

THE SILO AND THE CORN CROP.

No single agricultural step in marking the advance of methods of utilizing corn has been so important as the preservation of the crop in the green state in the silo. Between 1860 and 1870 the first silos for corn were used in Europe. The first record of silo construction in this country was in 1875, when two were built and used in Michigan. The days of experimentation with silage have now passed. Because it is an economical means of utilizing green feeds, especially corn, silage construction and the use of the silo are increasing rapidly, particularly in the dairy States. The following table shows the States leading in the number of silos:

Number of silos in the United States.

[From the Monthly Crop Report, August, 1917, of the Bureau of Crop Estimates.]

State.	Number of silos.	Capacity (tons).	
		Average.	Total.
New York.....	55,000	75	4,125,000
Pennsylvania.....	24,000	65	1,560,000
Ohio.....	25,000	67	1,675,000
Indiana.....	27,000	70	1,890,000
Illinois.....	30,000	79	2,370,000
Michigan.....	33,000	70	2,310,000
Wisconsin.....	55,000	87	4,785,000
Minnesota.....	15,000	95	1,425,000
Iowa.....	16,000	105	1,680,000
Missouri.....	13,000	90	1,170,000
Kansas.....	11,000	106	1,166,000
Kentucky.....	10,000	80	800,000
New England.....	35,000	67	2,345,000
All other.....	55,000	77	4,235,000
United States.....	404,000	78	31,536,000

The average number of milch cows in the United States in the decade 1908 to 1917 was 20 per cent more than in the previous decade. A large part of this increase is no doubt due to the growing popularity of the silo as a cheap means of preserving green feeds.

VARIATIONS OF THE CORN PLANT.

Whatever may have been the origin of corn, the fact remains that in its distribution over the United States it has undergone many and diverse modifications. Sturtevant reports heights of stalks varying from 18 inches for Golden Thumb pop corn to 22.25 feet for corn in Tennessee, and also reports individual ears with rows of kernels varying from 4 to 48. Variations in color are almost unlimited. Montgomery states that there are now probably 1,000 named varieties of corn in the United States, three-fourths of which have been developed since 1840. In 1898 Sturtevant listed 507 varieties.

Corn has shown especial adaptability to differences in length of seasons, and at the present time we find varieties maturing in 80 days in the North and other varieties requiring 150 days or more in the South. The types, consisting of pop, flint, flour, dent, sweet, and pod corns, indicate great changes in centuries of adaptation. In addition to their natural variations, but few plants in America have received more attention at the hands of the plant breeder than corn.

The plant breeder has found the plant to be very mobile, responding readily to selection. Proof of this is shown by the fact that selection has been found to influence the following characters: Shape of ear, height of ear, percentage of protein, percentage of oil, type of kernel, type of ear, width of leaves, color of kernel, size of cob, and many other characteristics. Through hybridization, valuable characters of different varieties have been brought together.

CORN AND THE STRUGGLE FOR DEMOCRACY.

Corn played a vital part in the European conflict. In response to widespread appeals, the acreage in 1917 was increased more than 10 per cent compared with 1916 and approximated 117,000,000 acres. The crop of 3,065,000,000 bushels was next to the largest ever harvested. If this crop had been loaded on wagons, each containing 50 bushels and allowing 20 feet of space for each wagon, these wagons placed end to end would make a line long enough to encircle the globe $9\frac{1}{2}$ times.

The importance of corn in the agriculture of the United States is well shown by the fact that in the decade 1908 to 1917 the acreage devoted to corn in this country was 4.8 per cent greater than the combined acreage of the crops of wheat, oats, barley, rye, rice, buckwheat, and flax. The value of the corn crop for the same period was 24.3 per cent more than the combined values of these crops. During the same decade, the number of acres in corn was 18.7 per cent in excess of that for the previous decade. A growing increase in the price per bushel for corn is indicated by the fact that the value of the crop was about 100 per cent greater in the past decade than in the previous one.

In many forms, corn is becoming more and more popular as a human food. It is the main cereal food of the cotton belt. Considering the food value of crops grown on an acre of land, corn heads the list, a 35-bushel crop producing nearly 150 pounds of protein and more than 3,000,000 units of energy.

Valuable, even in the remote past, as a sustainer of life among primitive peoples in peace and war, the importance of corn in the world's affairs becomes more and more manifest with each decade of time. Moving westward and northward as its merits became better recognized, its growth in production is closely associated with the building of canals, railroads, our national highways, and our commercial supremacy. Because of the manifold uses of every part of the plant, the production of corn is closely linked with the development and perpetuation of many great industries. Because of its wonderful adaptation to conditions, it is now grown with success in every State of the Nation, from sea level to lofty plateaus. In acreage, in multiplicity of uses, in production, and in value it exceeds any other cultivated crop. A corn-crop failure of any extent affects our supply of meat, lard, butter, and imports and exports. Its use as a substitute for wheat made it possible to release exceptionally large shipments of wheat to Europe, to supply the Allies and our own armies.

Having served a useful purpose in the early days of our country's history, corn is still indispensable in the development and perpetuation of our great Republic.

THE DRAINAGE MOVEMENT IN THE UNITED STATES.

By S. H. McCROBY,
Chief of Drainage Investigations, Bureau of Public Roads.

A GREAT AREA OF UNDRAINED LAND.

AMONG the great undeveloped natural resources of the United States are its one hundred and two million acres or more of swamp and wet lands. If collected in one place, these lands would have an area greater than that of the States of Iowa, Illinois, and Indiana taken together, or more than three-fourths of the area of France. These lands are found in every State, in tracts varying in size from a few acres to several million acres, and their soils vary greatly in character and in agricultural value. Data regarding area, extent, and character of our swamp lands are limited, but the most reliable information obtainable is here briefly set forth.

Area of swamp and wet lands in the United States.

	Acres.
Swamp -----	66, 900, 000
Periodically overflowed -----	31, 500, 000
Tidal marsh -----	4, 400,000
Total -----	<hr/> 102, 800, 000

Approximately three-fourths of these lands are timbered, but many have been cut over. Few data are available as to the area remaining in virgin timber, but it is estimated that at least 75 per cent of the land on which there is merchantable timber has been or is being cut over. In their present condition, the greater part of these lands return but a small income to the owners. On some, timber is growing which will yield some return when cut; the permanent swamp does not afford any other return except possibly a little poor pasture for cattle.

The lands that are periodically swampy, in addition to yielding some timber, afford a fair grade of pasturage for live stock. Such lands in some localities support good

growths of grasses that are valuable for pasture or hay; on other lands not so well located the pasture is thin. Tidal areas yield a little marsh hay or some poor pasture. It is apparent that in their present condition these lands are not returning a large income to their owners. The greater portion possess inherent fertility, and, if drained adequately, would make good agricultural land. In the present condition they are either too wet to cultivate, or the risk of losing a crop from overflow is so great that the farmer can not afford to take it.

MANY TYPES OF SOIL.

Many types of soil are found in the swamps; their agricultural value varies considerably. In those swamps where the ground is covered with water during the greater part of the year, the cumulose soils generally predominate (Pl. XIX, fig. 1). Much of the swamp land is not wet all the time, but only for a time after a heavy rain. Land of this character usually supports a heavy growth of vegetation. A large portion of the lands of this character formerly supported a heavy growth of timber. (Pl. XIX, fig. 2; Pl. XX, fig. 1.)

Lands that are overflowed periodically usually are in the flood plain of streams. The soils generally are of alluvial origin. The largest of these areas that are unreclaimed are heavily timbered. (Pl. XXI, figs. 1 and 2; Pl. XXII, fig. 1.) In addition to these lands, however, considerable areas of cleared lands along many of our streams are now cultivated but are greatly in need of improved drainage and of protection from overflow in order to make them available for cultivation. (Pl. XXII, fig. 2.) Small tracts frequently can be reclaimed by the construction of small ditches or a system of tile drains. (Pl. XXIII, fig. 1.) On the larger tracts, the problems are more complicated. It usually is necessary to construct large ditches that will serve as outlets for the drainage of the entire district, and these must be supplemented by sufficient lateral ditches to afford outlets for the farm drains. Usually, ditches of this kind are constructed by floating dredges or dry-land excavators. (Pl. XIX, fig. 2.) The machines used for constructing the ditches have been



B. P. R.—D 506

FIG. 1.—THE EVERGLADES WEST OF FORT LAUDERDALE, FLA.



B. P. R.—D 903

FIG. 2.—DREDGE DIGGING DRAINAGE DITCH THROUGH A SWAMP.



B. P. R.—D 1057

FIG. 1.—SWAMP IN BEAUFORT COUNTY, N. C., THROUGH WHICH DRAINAGE DITCH HAS JUST BEEN DUG.



B. P. R.—D 907

FIG. 2.—PERMANENT SWAMP LANDS THAT HAVE BEEN DRAINED AND RECLAIMED, BEAUFORT COUNTY, N. C.

Photograph taken four years after drainage was completed and the work of development started.



B.P.R.—D 921

FIG. 1.—PERIODICALLY OVERFLOWED LAND, GUM AND CYPRESS TIMBER, YAZOO DELTA, MISS.



B.P.R.—D 1176

FIG. 2.—PERIODICALLY OVERFLOWED TIMBER LAND, ST. FRANCIS BASIN, ARK.

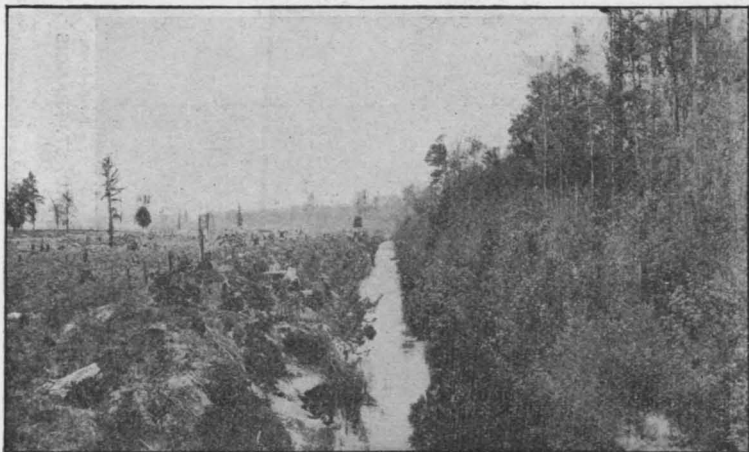

FIG. 1.—STREAM VALLEY, WHICH COULD NOT BE CULTIVATED UNTIL OVERFLOW WAS PREVENTED BY CHANNEL IMPROVEMENT, NORTH CAROLINA.

Partially cleared land on left, dredged ditch in center, timber on right.

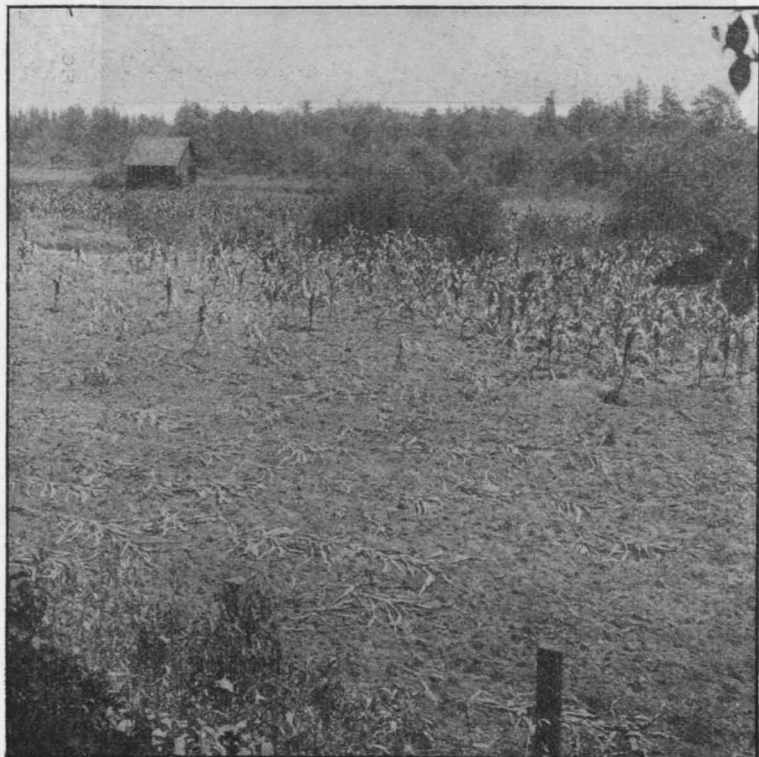

FIG. 2.—CORN ON POORLY DRAINED LAND, KILLED BY OVERFLOW FROM STREAM.

B. P. R.—D 1328



B. P. R.—D 423

FIG. 1.—POTATOES GROWING ON TILE DRAINED LAND.

On adjoining undrained fields the crop was a failure.



B. P. I.—D

FIG. 2.—CORN GROWN ON DRAINED SWAMP LAND IN EASTERN NORTH CAROLINA.

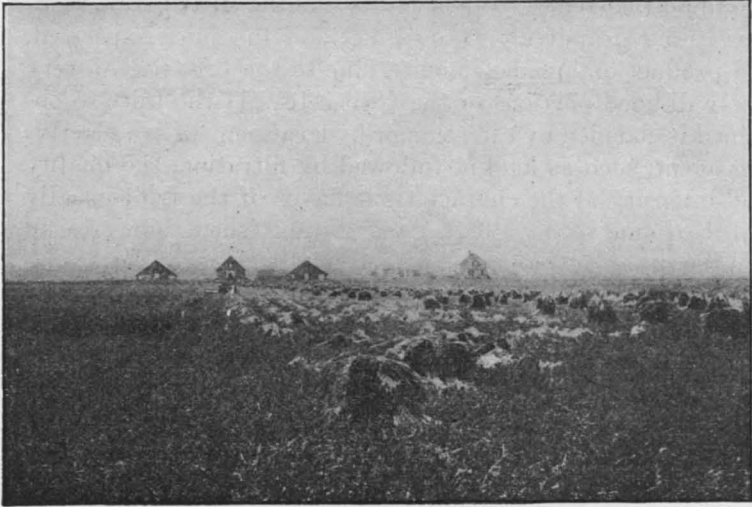

B.P.R.—D 1008

FIG. 1.—WINTER WHEAT GROWING ON DRAINED SWAMP LANDS IN ILLINOIS.

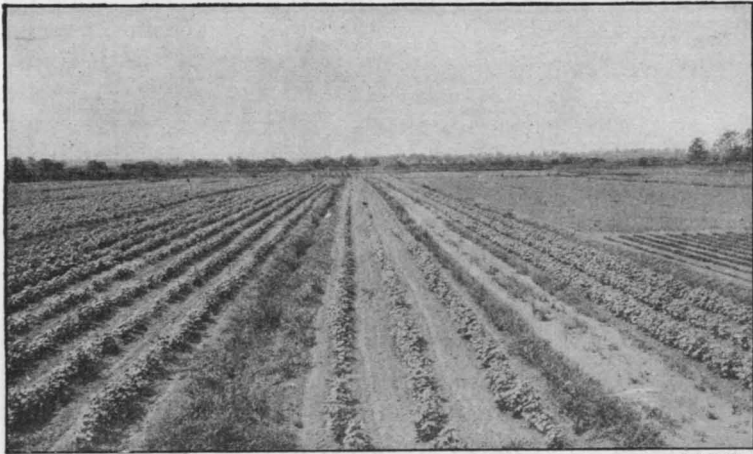

B.P.R.—D

FIG. 2.—COTTON AND TRUCK GROWING ON DRAINED SWAMP LAND IN SOUTH CAROLINA. THIS FIELD HAS BEEN CULTIVATED FOR MORE THAN 100 YEARS.

developed especially for this purpose, and dig ditches very rapidly at a low cost. A small floating dredge such as that shown in Plate XIX will excavate from 30,000 to 50,000 cubic yards or more per month.

The crops grown on the drained lands are the equal of those grown on the higher lands. The quality is of the very best. Some of the soils are especially adapted to special crops, such as celery, onions, and cabbages. Much of the celery in the United States is grown on drained marsh land. Most of the lands, however, are equally well adapted to the production of the staple crops. (Pl. XXIII, figs. 1 and 2.) Some have been in cultivation for more than 100 years and are still producing good crops.

DRAINAGE LAWS.

The drainage laws usually provide that on petition of a certain percentage of the landowners, or owners of a certain percentage of the lands, within the proposed district, an engineer will be appointed to examine the lands and determine whether they can be drained. If his report is favorable, the district is established, surveys made, and the necessary improvement planned and constructed. The district is a quasi-public corporation, which has the right to construct the necessary drains and do any act required for the reclamation or protection of the land. It has the right of eminent domain, can borrow money, and issue bonds. The special benefit that will accrue to each part of the land from the construction of the improvements is determined, and the costs are prorated to the several tracts on the basis of the benefits received, the lands that will receive the greatest benefit paying the highest tax per acre for the construction of the improvements. The district has the power to levy assessments to pay for the construction of the improvements. These are a lien on the land secondary only to the State and county taxes. Usually bonds are sold to provide funds to construct the improvements, and the landowners have the privilege of paying for the improvement in a number of installments. These bonds have a good reputation with investment bankers, and are very popular with conservative investors.

Under the provisions of such laws, much land has been reclaimed. The first projects of any magnitude were under-

taken in the upper Mississippi and Ohio Valleys. Unfortunately, no data are available with regard to the amount of land that has been reclaimed or the cost of the work. Some idea of the magnitude of the work may be gathered from the fact that in several counties in Iowa more than 100 districts have been established. There are more than 300 districts in one county, which is said to have spent more than \$10,000,000 on drainage improvement. Recently, information has been compiled regarding drainage work done in Michigan. During the 20-year period from 1898 to 1917, inclusive, drainage improvements costing \$18,859,576 were constructed in that State.

The work of reclamation has not been confined to the States in which it was first started. In 1909, North Carolina and Arkansas enacted modern drainage laws. Since that time all of the other Southern States have enacted similar statutes. In North Carolina, South Carolina, Georgia, Florida, Mississippi, Tennessee, Louisiana, Arkansas, and Missouri, under the provisions of these statutes, at least 7,000,000 acres have been included in drainage districts, where the improvements planned have either been constructed or now are under construction. The greater part of this land is now drained and most of the remainder will be drained by 1920. The work has not been confined to small projects alone, but many districts of considerable size have been organized. Among these are the Little River drainage district in Missouri, containing 555,000 acres, which is more than 90 per cent completed; the Cypress Creek district in Arkansas, containing 300,000 acres, fully 40 per cent completed; the Bogue Phalia district in Bolivar County, Miss., containing 140,250 acres, which was completed several years ago; and the Bogue Phalia district in Washington County, Miss., containing 150,000 acres, which has been completed recently. Most of the smaller districts have entirely completed construction.

CLEARING LANDS EXPENSIVE.

When drainage was first attempted on a large scale, the projects undertaken were located in a prairie country where the land was available for cultivation as soon as drained. Lands of this character were settled rapidly, frequently even before they were drained. In the eastern United States,

with the exception of the Florida Everglades, the wet prairie lands of southern Louisiana, and the lands along the Gulf coast in Texas, there are no large tracts of unsettled, unreclaimed lands needing drainage that are not timbered. The timbered lands must be cleared before they are available for cultivation.

On those lands where the timber is heavy the clearing is expensive and usually costs much more than the drainage. Clearing timbered lands is at best a slow and laborious process, and where wet lands must be cleared before field drains can be constructed it becomes even more difficult. The time required and the cost of clearing timbered lands have of necessity made the rate of development of these lands slow. On the prairie lands of Iowa and Illinois a man and three horses could break from $2\frac{1}{2}$ to 3 acres per day, and this land could be planted to corn or flax the year it was plowed. On heavily timbered lands, unless conditions are unusual, it will require more than a month's work for one man to clear an acre if all stumps are removed so that modern machinery can be used to cultivate the land.

It has been the general experience that the rate of development of timbered swamp lands has been slow after drainage, where the lands are drained in large tracts. The only notable exceptions to this are the black lands of eastern North Carolina, where, due to peculiar soil conditions, clearing can be done rapidly and at a very low cost per acre (Pl. XX, fig. 1). Where the drainage district is located in well-settled territory, the rate of development is more rapid. This has been particularly true of those districts in the South formed for the purpose of reclaiming the narrow valleys along the streams. Usually, the greater part of the hill lands adjacent to these valleys has been under cultivation for years and is thickly settled. The bottom lands generally are the most fertile in the district, and the demand for their utilization has been strong; as a result, their development has been rapid. On many such projects practically all the land is placed under cultivation within three or four years from the time the district is completed. In the districts draining large blocks of swamp lands, progress has not been so rapid.

Recently, information was collected in regard to 20 districts in eastern North Carolina. The districts have an area of 258,425 acres, of which 48,600 acres were cultivated prior to drainage. Since the lands have been drained, 32,600 acres have been cleared and placed under cultivation, making a total area of 81,200 acres now in cultivation in these districts. Of the area placed under cultivation since the lands were drained, 12,000 acres were located in one district of 16,000 acres, where an active selling and development campaign has been carried on by the persons owning the land. Conditions in the other States where similar timbered lands have been drained are much the same.

ADEQUATE DRAINAGE FUNDAMENTAL.

The settlers on drained swamp lands that have been timbered must clear the land and place it in cultivation before there can be any return from the investment. If the land is to be cleared rapidly, machines will be necessary, and additional labor must be employed. On even a small farm, this calls for considerable capital. If the settler has not the means to purchase necessary machinery and hire labor, he must develop the lands slowly, and it will be some time before he has available for cultivation sufficient land to afford him a living.

It is a fundamental requirement that if settlers on swamp or wet lands are to be successful they must have adequate drainage for their land before they attempt to cultivate it. It would do much for the success of such projects if some plan were worked out whereby a certain portion of each farm either could be cleared in advance of settlement or immediately after the settler goes on the land, so that he will have sufficient arable acreage on which to make a living while he clears the remainder of his farm.

COLLECTIVE ACTION NEEDED IN CLEARING LANDS.

Some attempts have been made to clear lands before they were sold. The price at which they are sold usually is so high that they are not attractive to prospective settlers with small capital. Other companies have agreed to clear the lands for the purchaser for a certain sum per acre or on a percentage basis; in some instances this plan has worked out very satisfactorily. There is, however, need for some plan

by which the work of clearing would be carried on by some public or quasi-public organization. One method by which this could be accomplished would be to broaden the powers of the drainage districts so that they could clear lands for the settlers, or a separate organization somewhat similar to the drainage district organization could be provided for the purpose of clearing the land. The cost of clearing in each instance would be charged to the land cleared. An organization of this character should have the power usually given to a corporation. The great advantage in such an organization would be that it could afford to purchase powerful machinery that the individual farmer could not afford to buy. The salvage from clearing operations on the land in the form of ties, posts, poles, logs, pulp wood, fire wood, etc., would be available in quite large quantities, and suitable machinery for working up this salvage economically could be provided. The output would be large enough to be sold in carload lots or larger.

The organization should be authorized to borrow money and to issue bonds so that the cost of the work could be spread over a period of years. Such an organization could no doubt borrow money on better terms than individuals. On a large project, after the work was well organized and experience gained, the organization should become more efficient and there would be a material reduction in the cost of such operations. Experience with drainage districts indicates that once clearing operations are undertaken on a large scale instead of piecemeal there will be a great reduction in the cost of the work.

COOPERATION AN ADVANTAGE.

Land companies should not be permitted to sell or to settle lands that are being drained until adequate drainage works are practically completed. Many worthy settlers have lost their all by settling on wet or swamp lands before they were drained and because they did not understand the difficulties of making such lands ready for farming. It should be remembered always that proposed or prospective drainage districts do not provide drainage until the works are constructed.

If our swamp and wet lands are to be developed at a fairly rapid rate, it is clearly necessary that some form of organization for the reclamation that carries the work further than the drainage district must be provided. Under existing conditions, reclamation on these lands is a long and laborious process that can be accomplished only very slowly unless the settler has ample funds to finance his improvements. The man with only his hands and a small working capital meets with many difficulties, some of which he frequently finds insurmountable, and the result is that many settlers do not make good. If the plan suggested or something similar could be worked out and put into operation, so that the settler could have the use of the best machinery available for clearing his land and for working up the by-products from the clearing operations, and the privilege of paying the cost of this work in installments which would be spread over a number of years and draw a low rate of interest, his prospects for successfully reclaiming his farm would be greatly improved. The result would be that these lands would become much more attractive to the prospective settlers.

There are large areas of wet and swamp lands available near many of the large industrial centers of our country, which, if properly drained and reclaimed, could be transformed into homes for the returned soldier, sailor, or munition worker who desires to settle on the farm. If, however, the settler on such land must continue to finance the development of these lands from his own capital, as in the past, without the aid of any form of cooperative organization, the projects are not very attractive to anyone except the person with ample capital, who usually does not care to undertake such enterprises. If the majority of the settlers on these lands are to be successful, they must have an opportunity to work collectively in the clearing of their lands, just as they now have the opportunity to do in the drainage of these lands. When such an organization is perfected, large areas of these lands should be transformed rapidly from the swamp into happy homes.

RABBIT GROWING TO SUPPLEMENT THE MEAT SUPPLY.

By NED DEARBORN,
Assistant Biologist, Bureau of Biological Survey.

NECESSITY FOR MORE MEAT IN THE UNITED STATES.

CONSUMING annually more than his own weight of meat, the average American regards it as an essential part of his diet. But with its cost mounting higher and higher, many people can no longer afford to buy the better cuts. Former low prices of meat can not be expected to return, for, in keeping with the principles of diversified farming, much of the vast unfenced range of the West has been divided into farms producing less meat but more cereals and dairy products. Not only is our output of meat proportionally less than formerly, but its cost per pound has increased with increasing land values and expenditures for buildings, fences, labor, and taxes. To meet the requirements of a growing population, more grain has been produced, but meat production has not kept pace with it. High prices attract to our shores meat from foreign countries, and, strange as it may seem, the United States, which ranks first among the meat-producing countries of the world, ranks fourth among those importing meat.

In attempting to solve the meat problem, we may well profit by the experience of thickly populated countries of the Old World, where long ago it became necessary to learn to produce meat by raising animals which would thrive under restricted conditions. The fact that raising what we ordinarily consider meat animals—cattle, sheep, goats, hogs, and poultry—costs more than formerly makes it very evident that the meat supply must be supplemented from other sources.

The course of events during the stress of the world war in congested countries of Europe and also in the United States indicates how waning supplies of meat may be most conveniently and economically supplemented. When beef fails,

horseflesh frequently becomes its substitute. While wholesome enough, horseflesh does not appeal to the American appetite, and its general adoption as food is not anticipated so long as other kinds of meat are available or can be developed. A far more promising meat animal is the rabbit, which, both wild and domesticated, has long been used extensively as food in Europe, and to a comparatively small degree in this country.

There are four animals which may be kept by thrifty people to convert farm and garden refuse into meat—the chicken, the goat, the pig, and the rabbit. Any one of the first three is likely to become a nuisance in a thickly settled community unless great care is taken, but scores of silent, wholesome rabbits may easily be kept on a city lot without giving the slightest offense.

CONSUMPTION OF RABBIT MEAT IN EUROPE.

Before the outbreak of the war in 1914, rabbits were kept on the farms and in the towns of northern France and Belgium for home use and for market as commonly as poultry. In the greater part of Europe, excepting the more northerly portions, rabbit breeding was an important industry. About 100,000,000 rabbits were marketed annually in France. Approximately 2,200,000 rabbits were raised in Belgium in 1898 for home consumption and for export. The value of rabbits annually exported from Ostend to England exceeded \$1,000,000, while, including wild hares raised in her game preserves, England herself was producing from 30,000,000 to 40,000,000 rabbits. In 1911, the consumption of rabbits in London amounted to 500,000 pounds daily, and in Paris to 200,000 pounds. The use of rabbits for food is not a novelty in England, for, as far back as 1874, 350,000 rabbits were sold annually in Birmingham, 300,000 in Manchester, 200,000 in Nottingham, and 150,000 each in Sheffield, Newcastle, and Leeds. The value of rabbit meat imported into Great Britain through London from Australia and New Zealand was \$4,500,000 in 1910. In Germany, rabbits have been raised mainly for consumption in the homes of the breeders. Bavaria produced 415,000 rabbits in 1911. This aid to the solution of the meat problem in Europe is practicable in America.

RABBIT GROWING IN AMERICA.

For many years rabbits have been raised in this country as pets and as fancy stock for competitive exhibitions. Until recently, however, there has been no real incentive to breed them for practical ends, as they were not actually needed for food, and better fur than theirs could be had for little money. So long as they were looked upon merely as pets they were rarely utilized for food.

Wild rabbits are common everywhere. They are hunted and trapped by farmers, sportsmen, and others and are consumed at home or sold as game. Between November and March they are shipped in carload lots from the Great Plains to Boston, New York, and other eastern cities. Virginia and the States in the Mississippi Valley furnish a great many wild rabbits for local markets. At a time when round steak was selling at 12½ cents a pound and cottontail rabbits at 25 cents a pair or even at 25 cents each, no one was interested in raising rabbits for the table.

During the years 1899 and 1900, while the cost of food was still low, there occurred what has been known as the Belgian-hare boom, which, while it lasted, attracted much attention. Importers went to England for pedigreed breeding stock, pedigrees being at that time rather more highly thought of than the rabbits themselves, and shipped back dozens of Belgian hares every week. Wealthy fanciers went to great lengths for prize-winning stock. Fifty dollars was not an unusual price for one of these rabbits at breeding age, and \$265 is said to have been paid for one rabbit imported for exhibition at a show in Chicago in 1899. The boom spread rapidly and continued as long as there was a demand for such breeding stock, but when the demand came down to a meat basis the boom collapsed, as there was then no real need for a new source of meat.

Lately, people here and there have very quietly taken up rabbit raising, first for home use, then for sale. This movement, undertaken to supply an actual need for meat, is fulfilling expectations. City and suburban dwellers are raising rabbits in back yards. Although the total production is yet comparatively small, it is steadily increasing. In certain localities in California, Oregon, Washington, Colorado,

Kansas, Missouri, Michigan, and several other States, the domesticated rabbit is recognized as a regular meat animal. Rabbits are either shipped alive to market in crates or are neatly dressed ready for cooking and packed in a sanitary manner for transportation.

The saving and earning power of rabbits is illustrated by the following concrete examples of what is actually being done with them: One resident of Kansas City, Kans., raises 300 or 400 pounds of rabbit meat a year for his own table at a cost of only 8 or 10 cents a pound. Another resident of the same city, who breeds registered stock on a space measuring 20 by 24 feet in his back yard, has raised and sold enough rabbits in 18 months to clear \$2,400. A large religious institution in Nebraska raises rabbits instead of poultry and reports the meat more satisfactory than chicken, and the experiment profitable. According to a former county commissioner of the State of Washington, rabbits were grown on the county farm to provide for the county hospitals a substitute for chicken; the initial stock numbered 119 rabbits, which increased to 1,200 in 10 months, besides those used in the hospitals. These are not isolated cases, they are simply examples of what is being done in rabbit raising, and are an indication of what this industry is likely to become when its profitableness is more generally recognized.

UTILITY BREEDS OF RABBITS.

Of about 20 varieties of rabbits competing at American shows under established standards of size, form, and color, there are seven which, because of size, are classed as utility rabbits. These seven are comprised in three types, represented by the so-called "Giants," the Belgian hares, and the New Zealand red rabbits.

THE GIANTS.

One group includes the different varieties of giants, which, according to their color, are named gray, steel gray, checkered, and solid colored, as black, white, or blue. All are long-bodied and massive, weighing when adult from 11 to 20 pounds each. Across the throat of the doe is a thick

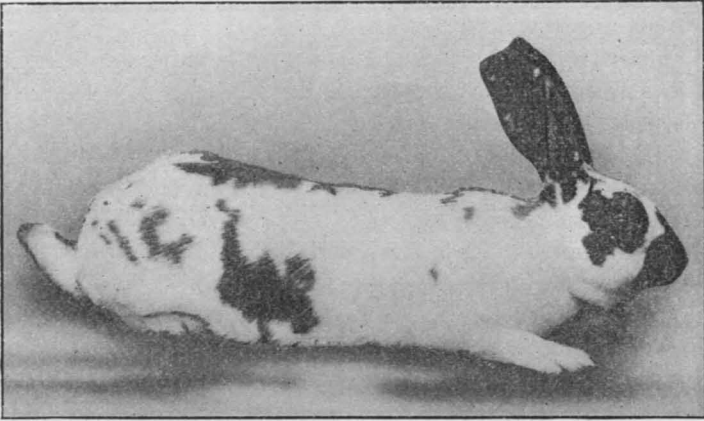

FIG. 1. CHECKERED GIANT.

B1149M

A rabbit valuable for both food and fur; weight from 11 to 13 pounds.

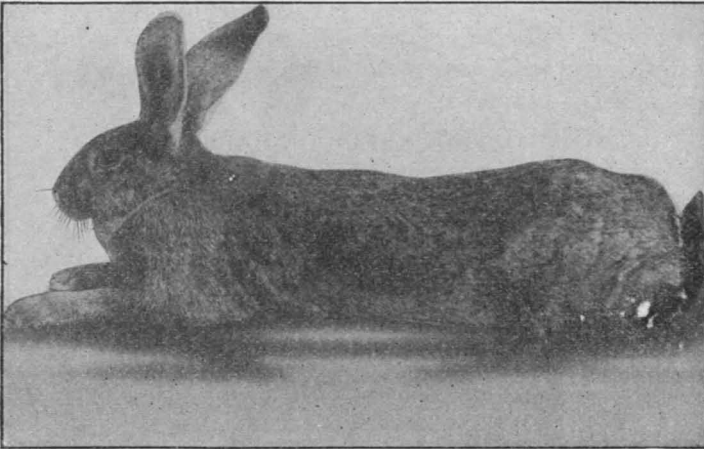

FIG. 2.—GRAY GIANT.

B1190M

A utility rabbit weighing from 11 to 20 pounds.

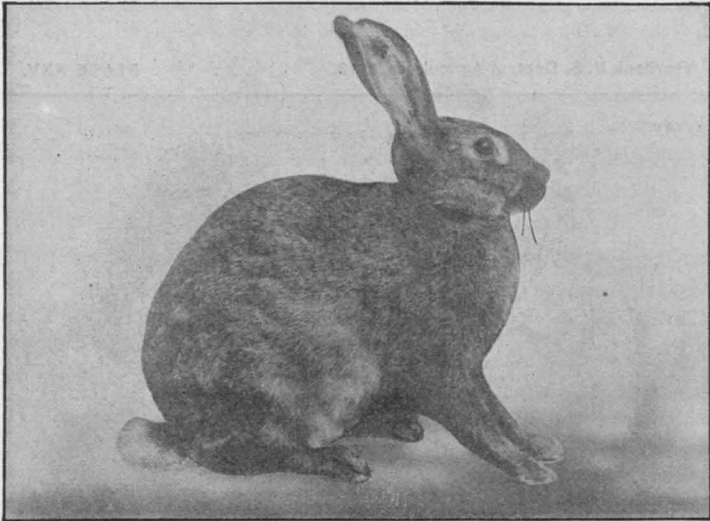

FIG. 1.—BELGIAN HARE.

B1161M

The first utility rabbit introduced into this country; a slender, muscular animal, weighing about 8 pounds.

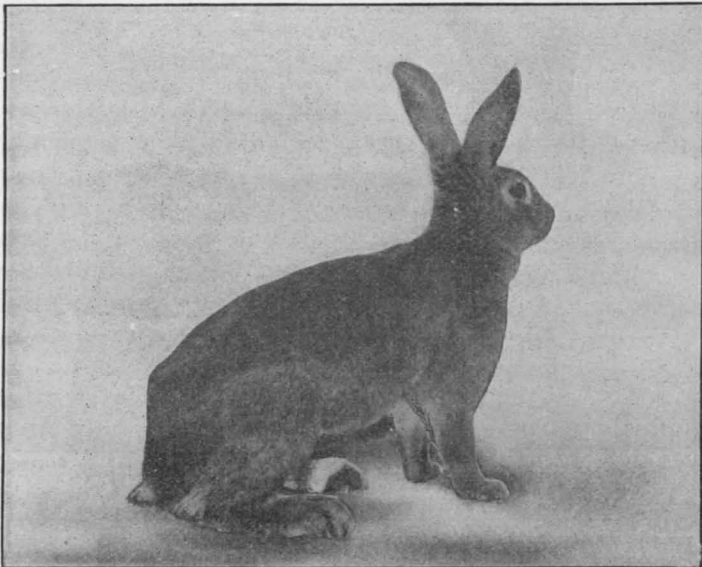

FIG. 2.—NEW ZEALAND RED RABBIT.

B1162M

A rabbit intermediate in size between the Flemish giant and the Belgian hare; weight, from 9 to 10 pounds.

fold of skin called the dewlap, which is conspicuous when the chin is drawn inward. The grays run especially heavy, the standards calling for a weight of at least 13 pounds. The standard for checkered giants requires a weight of 11 to 13 pounds. Giants are mature when about 15 months old. Those raised for meat purposes are usually sold before attaining full size, as the flesh of young rabbits is preferred to that of old ones. Checkered giants were developed in Germany. The other varieties, ordinarily grouped under the name Flemish giant, originated in that part of Belgium and northern France known as Flanders. Flemish giants are now bred in all parts of the country. They grow rapidly, withstand cold well, and where the market demands a heavy type of rabbit, they are highly recommended.

BELGIAN HARES.

The Belgian hare, one of the second group, has descended from giant stock brought to England from Belgium, France, and Germany. In the hands of British fanciers its size has been reduced, its limbs lengthened, and its general appearance changed by selective breeding to such a degree that it now looks and acts like the wild European hare. In recognition of this resemblance it was formerly called the Belgian hare-rabbit, a name since contracted to Belgian hare.¹ It is a slender, muscular, and graceful animal. According to the present standard, its proper weight is about 8 pounds. Typical does do not have the dewlap. The color of Belgian hares ranges in different specimens from a bright orange-brown or tan to mahogany, varied by a mingling of black hairs, which gives the effect known as ticking. The Belgian hare was the first utility rabbit to make its appearance in America, and although it was introduced when conditions were unfavorable for its adoption as a meat animal, it has remained a favorite with fanciers, and at last seems destined to fulfil the purpose for which it was unsuccessfully advocated a score of years ago. The "rufous red" Belgian is one conforming to the American standard as to color,

¹ One difference between rabbits and hares is the condition of the young at birth. Rabbits, including the cottontails of America and the rabbits of the Old World, are born blind and naked. Hares, on the other hand, including the so-called snowshoe rabbits and jack rabbits of this country and the wild hares of Europe, are covered with fur and have eyes open at birth.

which is a dark cherry-red or mahogany, uniform over head, ears, chest, feet, back, and sides, varied by scattered black hairs.

NEW ZEALAND REDS.

A third type of utility rabbit is the New Zealand red, an animal intermediate in size and form between the Flemish giant and the Belgian hare. It may have been produced by crossing the white Flemish giant with the rufous-red Belgian hare. This is suggested by its size and color, and by the fact that the earlier specimens had considerable white on the legs. It may, however, have descended, as has been claimed, from rabbits obtained by sailors in New Zealand and sold to California fanciers. Its origin is of less interest than its development, which has been accomplished in California since 1909, when it first gained recognition. Although the name New Zealand red may have no geographical significance, it fairly describes the standard color of this animal, the back and sides of which are of a clear reddish buff, free from black hairs. At maturity, which is attained at the age of one year, New Zealand bucks should weigh 9 pounds and does 10 pounds. The doe has a dewlap similar to that of the giants. This rabbit is compactly built, with thick hind quarters. It is best known near the Pacific coast, where it first appeared, but it is being bred to some extent in practically all the States.

OUTLOOK FOR RABBIT BREEDING.

Evidently something should be done to lower the high cost of meat. Meat produced at home saves freight and several profits. The example of Europeans and the experience of breeders in America indicate that the utility rabbit will be a large factor in solving the meat problem. The question of food has been brought very close to us. The doctrine of the clean plate has been revived. Many have turned their yards into vegetable gardens and have been delighted with the results. Many have started rabbitries and are enthusiastic about them. In every garden there is feed for rabbits, feed that will be wasted unless there are rabbits to eat it. Dandelions are a pest in lawns, but they are excellent

rabbit feed when used with alfalfa or clover and oats or other grain, as also are leaves of the burdock, yellow dock, and other weeds, and prunings from apple and cherry trees.

The first object in rabbit raising is to supply home needs. The best indorsement an article can have is the fact that it is used freely by its producer. If one is inclined to disdain domesticated rabbits on account of experience with wild rabbits, he should consider that the latter, as sold in butcher shops, are not to be compared as a delicacy with tender young hutch rabbits.

Rabbit skins are being used in increasing quantities for fur, as the supply of wild fur decreases and as improvements

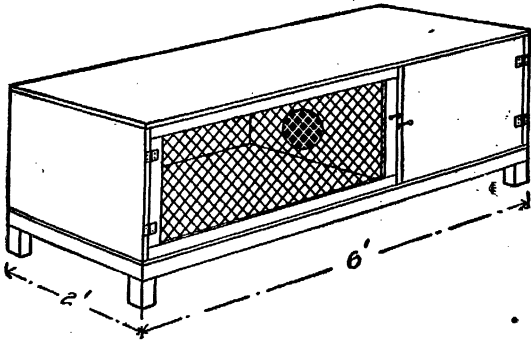

FIG. 2.—A convenient rabbit hutch which may be used on a plot of ground as small as a city back yard, or even on a back porch, without resulting in the noises and odors so common about poultry yards and pig pens.

in tanning and dyeing contribute to make the pelts more attractive. Some of the varieties of utility rabbits have pleasing colors naturally. For example, the checkered giant, which is mainly white, with conspicuous spots or patches of color on head, back, and sides, has been exploited as a fur rabbit on account of its striking color contrasts. Pelts of solid-colored rabbits, however, when prime, sell readily for fur purposes and are used extensively in natural colors and also, after being dyed, in making muffs, capes, stoles, and trimmings for garments. Rabbit fur is used also in making felt hats. Many thousands of pounds of rabbit skins are bought by manufacturers of hatters' fur in this country every year. After the fur is removed the skins are utilized in making glue.

Boys' and girls' clubs, organized by the United States Department of Agriculture and State agricultural colleges, have been a most important factor in demonstrating the good points of rabbits. Boys, girls, and older persons having leisure can do much to increase the production of meat and fur by applying their spare time and energy to raising rabbits. Whenever rabbit raising has been undertaken in a community a demand for breeding stock and meat sufficient to absorb the surplus has quickly arisen.

A survey of existing conditions, including the food situation and the economical tendencies of the times, as well as the development of the rabbit industry at home and abroad, justifies the assertion that the outlook for rabbit breeding in America is good. In recognition of this prospect, the Department of Agriculture is prepared to furnish advice on the breeding and marketing of rabbits, to assist in forming clubs, and to gather and distribute information as to breeding stock, current values of rabbit meat and fur, and other matters affecting the rabbit industry.

HOW DAIRYING BUILT UP A COMMUNITY.

By J. C. McDOWELL,

Agriculturist, Dairy Division, Bureau of Animal Industry.

PAST AND PRESENT CONDITIONS.

BEFORE the creamery was built at Grove City, Pa., there had been little real progress in agriculture in that community, where an unsatisfactory type of general farming had been followed for about 100 years. On many farms cattle and horses were kept in barns and stables that were low, dark, and poorly ventilated. Poorly kept rail fences inclosed the fields and pastures. Butter in small quantity and sometimes of doubtful quality was sold on a sluggish market, and as a consequence the average family income was comparatively small. At that time the farmers received a small cash income twice a year; in the summer from the sale of wool, and again in the fall from the sale of grain and steers. Occasionally they made a little money by selling timber or hauling coal, and their wives traded butter and eggs for groceries.

In those days crops were generally poor, owing to low soil fertility and lack of proper cultivation. The few crops that could be sold were hauled over poor roads to poorer markets. On most farms some dairy cows were kept, but they were of the scrub variety, and few farmers took any interest in the improvement of their herds. Occasionally a spasmodic attempt was made to bring about improvement, but lack of a true spirit of cooperation always prevented successful accomplishment.

About 35 years ago a cheese factory was built at Grove City. The first 6 months it paid promptly for all milk delivered, the next few months the pay was slow, and at the end of a year the factory was forced to close its doors. A few years later a creamery was built, but it proved to be almost as great a failure as the cheese factory and after a more or less precarious existence of 3 or 4 years it was sold out by the sheriff.

These failures caused the farmers to look with suspicion upon any new movement toward cooperation, especially of a dairy nature. Consequently, in 1914, when the Dairy Division of the United States Department of Agriculture was looking for a suitable location for an experimental creamery, the idea did not appeal strongly to the farmers near Grove City, but it did meet with favor among the more progressive business men of the town. At that time no spirit of helpful cooperation existed between the town and the country. Farmers were rather suspicious of the city people and sometimes openly antagonistic, while the people of the city seldom let their interests extend beyond the city limits.

During the last 3 years, or since the creamery and dairy-development work began, a radical change has come about, and to-day the Grove City community comprises both the town and the country for miles around and has become a model for other communities in all parts of the country. At least eight other communities in Pennsylvania and near-by States have undertaken similar dairy-development work, and all are using the Grove City community as their model.

RAPID INCREASE IN PATRONAGE.

Improvement dates from May 3, 1915, the day the Grove City creamery began to operate. The first day 20 patrons brought whole milk or cream which contained a total of 78 pounds of butterfat. By June 30 of the same year, the number of patrons had increased to 106, a year later to 338, the next year to 579, and at the end of the third year, or June 30, 1918, it was 614.

These figures show a rapid and constant increase in the number of patrons, but the increase in the income is even more remarkable. The first fiscal year, or from July 1, 1915, to June 30, 1916, inclusive, the gross income of the creamery was \$82,432; the second year it had increased to \$212,904, and the third year it was \$375,596.

As only a small part of the money was used to pay the cost of operation, nearly all of it was distributed among the farmers around Grove City. Since much of the income was due to increased and improved farm business, a large part of it may fairly be considered as newly created wealth. This is particularly the case in connection with the income from

cottage cheese and buttermilk. The first year the returns from cottage cheese were \$2,040, the second year \$7,571, and the third year \$23,448. The first year the creamery was in operation the income from buttermilk was \$508, the second year \$3,636, and the third year \$5,895.

The creamery management has reduced waste to the minimum. Upon the receipt of either milk or cream in good condition, the butterfat is made into first-class butter which always meets a ready sale at the highest market price. All the by-products, except the whey, are utilized. The skim milk is condensed or made into cottage cheese or casein. The buttermilk is sold direct, made into casein, or, combined with skim milk, it is made into cottage cheese. What use shall be made of any dairy by-product depends upon the demand and the price, but the by-products are never wasted at the Grove City creamery.

The fact that the creamery is managed by the Department of Agriculture probably gives it no appreciable financial advantage, because that relationship is investigational and has not reduced the cost of manufacture below that of many other creameries. The products are always sold on their merits, and the name of the department is not used to advertise them. What the Grove City creamery is doing can be done by any creamery that is situated satisfactorily.

A creamery field man is employed by the Department of Agriculture to assist in bringing about local dairy development. The chief purpose in attempting this work is to determine whether such dairy development will justify the cost, and whether it is advisable for other creameries to employ a field man to look after their work. It is difficult to measure such work in dollars, yet it is largely through the influence of the field man that dairying has been able to build up the Grove City community.

GROVE CITY CREAMERY SATISFIED REQUIREMENTS.

Previous to 1914, the Dairy Division investigated several sections of Pennsylvania, southern New York, and eastern Ohio looking for a suitable location for a creamery for experimental work. It was considered that this creamery should be removed as far as possible from competition with the city milk trade; that it should be free from competition

with any creamery or cheese factory already established; and that it should be in a community willing to construct and equip a suitable building. Because the district around Grove City had all these requirements and because of the general attitude of the business men of the city, as well as the possibilities for dairy development in that section, it was decided to locate the experimental creamery at Grove City.

RESEARCH WORK ON COMMERCIAL SCALE.

The Dairy Division desired to operate a creamery in order to place the results of the research work on a commercial scale. When investigations in the Washington laboratories give results which promise to have practical value, they are tested as thoroughly as possible under miniature factory conditions and finally given a trial under commercial conditions in the Grove City creamery before they are made public. Considerable investigational work is in progress in the creamery, especially in connection with the utilization of by-products, the manufacture of a uniform grade of casein, and the use of buttermilk in making cottage cheese.

In cooperation with the United States Public Health Service, much has been done to solve the problem of creamery sewage disposal. The business operation of the creamery is being carefully studied also in order to determine the best system of cost accounting for creameries of various capacities.

THE AWAKENING OF A COMMUNITY SPIRIT.

The success of the Grove City creamery is due largely to the admirable community spirit that now exists in the district. Formerly there was no spirit of cooperation among the farmers and but little effort toward public improvement. That this spirit exists to-day is owing largely to the efforts put forth by the business men of Grove City, especially the members of the Commercial Club. From the very beginning they took an active interest in the creamery and in the movement toward general agricultural development through dairying; and by their enthusiasm they aroused the interest of the farmers. The business men of Grove City took the first step, the farmers met them halfway, and all are now working for a common cause, which is the building

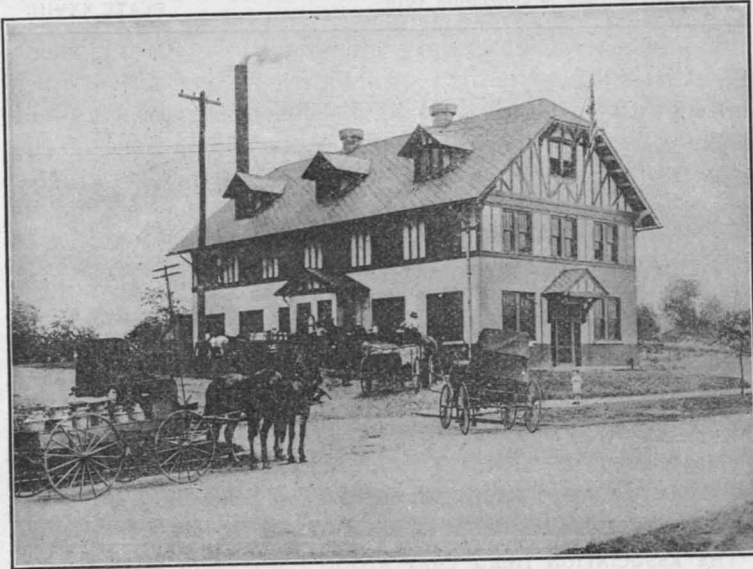

THE CREAMERY AT GROVE CITY, PA.



THE BUTTER MAKERS AT WORK.

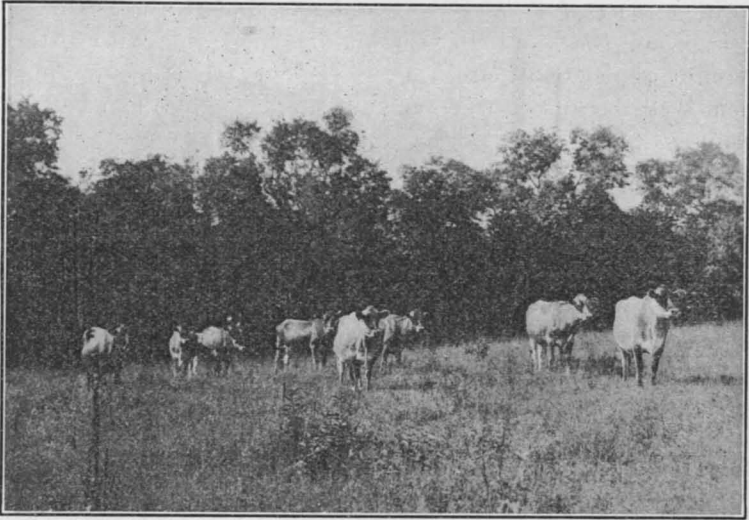

THE ASSOCIATION HERD THAT STOOD HIGHEST IN BUTTER-FAT PRODUCTION IN 1918.

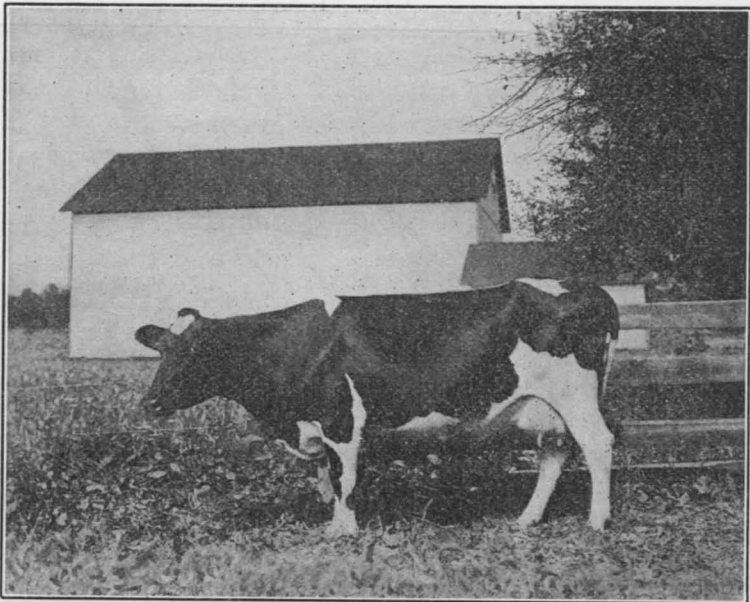

THE HIGHEST MILK PRODUCER IN THE GROVE CITY COW-TESTING ASSOCIATION IN 1918. HER RECORD WAS 11,048 POUNDS OF MILK.

up of a successful dairy community. Though the business men began the work for the public good and with little thought of personal gain, they have found that it is paying them well, because better farming has brought them better business. As the farmers have more money, they buy more; and where they formerly bought on credit they now pay cash.

THE COMMERCIAL CLUB.

To make the Commercial Club a real community organization, farmers were admitted to membership, and at the present time about 20 of the 200 members are farmers. The farmer members are very regular in attendance and, being men of considerable ability, they have much influence in shaping the policies and in carrying on the work of the club. The clubrooms are always open to farmers, and are frequently used as rest rooms for their wives and children. Farmers' meetings are always held in the rooms of the Commercial Club, where farmers from a distance who come to Grove City to buy cattle, to study conditions, or on other business, frequently are entertained. Often the club has been active in obtaining help for the farmers during busy times. Sometimes the members themselves have volunteered to assist the farmers for a few days at a time. Under such circumstances they usually charge regular wages, but during the war they commonly turned their earnings over to the Red Cross.

HELP FROM THE LOCAL BANKS.

From the beginning both national banks have supported the movement, and one of them has given constant financial aid in helping to finance the purchase of pure-bred dairy sires for the bull associations. It has purchased and imported from other States several carloads of pure-bred cows and sold them to the farmers of the community at cost. Whenever carloads of cattle have been brought in, the bank has advanced the money and assumed the risk. The cattle are then turned over to the farmers at cost plus the expense of purchase and transportation.

The first carload was apportioned to the farmers by lot, each one paying the actual cost of the cow whose number he drew. In the case of later purchases, however, before the cattle were

bought the farmers indicated what they wanted, and each farmer took what he had ordered. The bank has also gone to considerable expense in connection with the buying and bringing in of pure-bred calves to be distributed among the members of the Boys' and Girls' Pure-bred Dairy Cattle Club.

Although the bank has financed the purchase of eight carloads of pure-bred cattle, and assumed the responsibility of loss in shipping, it has never lost a dollar in any of the transactions. In every case the demand has been for more cattle than have been brought in. All this has been done in a district where dairying was not a success 5 years ago and among people who at that time would not have raised money to purchase a pure-bred animal of any kind. In fact, before the development work began, the names of the great dairy breeds were almost unknown to many of those farmers who now own pure-bred stock of merit. Few understood the meaning of a pedigree; now many are well acquainted with the records of the leading animals of their chosen breeds.

The bank has also helped the farmers in other ways. It lends money to them for the purchase of better cows and pure-bred sires, and for general farm improvement. Money that formerly was sent away to be lent in the large cities is now kept at home and lent to the farmers at a reasonable rate. Instead of developing industries in the big cities to draw the young people from the country districts, the money is now kept at home to develop and enrich the community. The profits that come to the farmers from such development are often deposited in the local banks and again lent to improve the country and create more wealth.

The bank issues a very interesting monthly publication whose purpose is to bring about community development by making country life more interesting and profitable. In addition to articles of general and local interest the publication creates a friendly rivalry by publishing each month the names of the farmers who receive the largest checks from the creamery and the names of the owners of cows whose average butterfat production during the preceding month was more than 40 pounds. Its pages are full of interesting dairy notes, most of which are local, and occasionally there is a

detailed account of the management of some successful farm in the community. Undoubtedly this publication, which is distributed free to the patrons of the creamery, has been an important factor in developing a community spirit of cooperation.

VALUE OF COW-TESTING ASSOCIATION.

The most direct cause of the greatly increased prosperity of the Grove City community is the profitable dairy cow. Dairying in the Grove City district has been much improved by the pure-bred cattle that have been shipped in, but it has been improved more by the scrub cattle that have been shipped out.

The cow-testing association, which has taken the guess-work out of dairying in that district, is an organization of about 26 dairy farmers who employ a tester to test their cows for production and to keep feed and production records. The following are direct quotations from members of the Grove City Cow-Testing Association: "When I go out of the cow-testing association, I am going out of dairying." "The cow I thought was my best turned out to be the poorest in the herd." "By keeping fewer and better cows I have reduced the expenses and increased the income." "My balanced ration alone is worth enough to pay for all the association has cost me." "The cow-testing association has been worth a thousand dollars to me." "I was over at Henry Smith's farm the other day. Henry is very proud of his small herd of registered Guernseys. He talked pedigrees and blood lines as though he had been in the business 30 years. Why, a year ago Henry didn't know a Guernsey from a Jersey!"

One member of the cow-testing association feeds the young calves whole milk from the lowest-testing cows, and sends all the milk of the high testers to the creamery. He reports that the calves do fully as well on the low-testing milk and that the butterfat saved more than pays all expenses connected with the testing.

As soon as the cow-testing association proves that a cow is unprofitable she is disposed of and a better cow is purchased to take her place. One farmer found that 9 of his 11 cows were unprofitable. He immediately sent all nine to the

block and began buying better ones to take their places. No one considers going out of the business. Everywhere "Improvement" is the watchword.

The Grove City Cow-Testing Association records for 1917 and 1918 show that it cost an average of \$74 per cow to feed the 262 cows that completed a year's test—about \$50 to feed the lowest producers, and \$97 to feed the cows whose average production was 400 pounds or more of butterfat a year. The 11 cows that averaged 400 pounds of butterfat a year had an income of \$128 over cost of feed, while the 15 cows that averaged 100 pounds a year had an income of about \$5 over cost of feed. One cow, therefore, that produced 400 pounds of butterfat a year produced more income over cost of feed than 25 cows of the other class. These results indicate that the owners of well-bred and well-fed cows may derive pleasure as well as much profit from dairying.

The cow that produced 200 pounds of butterfat a year returned \$1.57 for each dollar spent for feed, while the cow that produced 400 pounds of butterfat a year returned \$2.43 for each dollar spent for feed. It cost more to feed the cow that produced 400 pounds of butterfat, but for every dollar spent for feed she returned 86 cents more than the average cow of the other group. She produced a pound of butterfat in return for 23 cents' worth of feed, while the average cow of the other group required 36 cents' worth of feed to produce a pound of butterfat.

Of the cows that were on test 12 months those that freshened in April, May, June, and July had an average income of \$45 over cost of feed, while those that freshened at other times had an average income of \$60 over cost of feed. There were 9 cows whose owners did not know the dates of freshening. These 9 cows had an average income of \$7.82 over cost of feed.

The low income over cost of feed may not have been due to lack of records, but it seems something more than a coincidence that the dairymen who did not keep records were the owners of poor cows.

TWO BULL ASSOCIATIONS ORGANIZED.

Two cooperative bull associations, Jersey and Holstein-Friesian, have been organized since the development work began. These are farmers' organizations whose purpose is

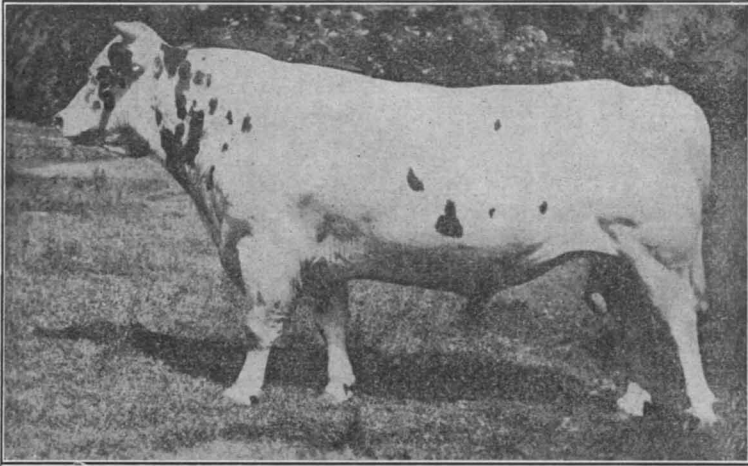

ONE OF THE SIRES THAT HAVE HELPED TO IMPROVE THE DAIRY HERDS.

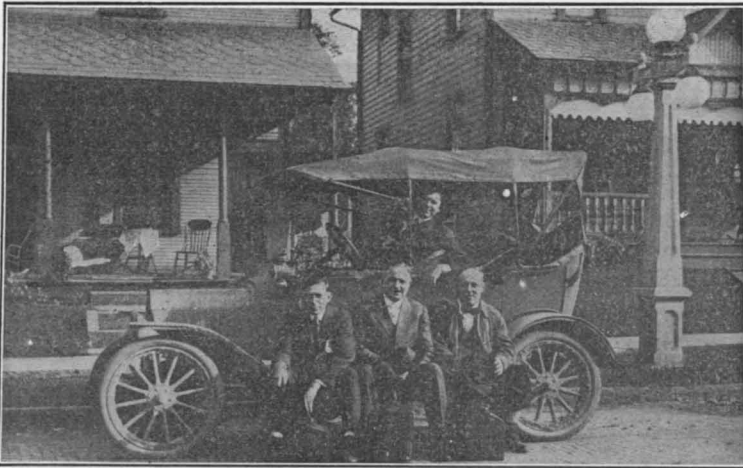

THE FIELD MAN AND THREE VETERINARIANS ABOUT TO GO TO NEAR-BY FARMS*TO TEST CATTLE FOR TUBERCULOSIS.



THE CALF THAT WON FIRST PRIZE AT THE STONEBORO FAIR, AND HER OWNER.



A MODERN FARMHOUSE NEAR GROVE CITY. A RESULT OF THE PROFITS MADE FROM THE DAIRY HERD.

the joint ownership, use, and exchange of three or more high-class registered bulls. They are divided into sections or blocks, with one bull to each block. Each of the Grove City associations consists of 4 blocks, and each requires that all its members shall agree to have their herds tested for tuberculosis under the State and Federal accredited-herd plan.

The Holstein-Friesian Bull Association was organized about 2 years ago by 25 farmers who subscribed \$75 each. With this money they purchased 4 registered Holstein sires of meritorious breeding. They divided their territory into 4 breeding blocks and placed one bull near the center of each block. To avoid inbreeding the sires are to be changed from one block to another every 2 years. In that way the bulls can be used for 8 years. Thus 25 herds are furnished with good sires for 8 years at an initial cost of \$75 to each farmer and at a maintenance cost of about one-sixth of what it would be if each herd were headed by a scrub bull. While no records of the daughters are obtainable, the calves, in their conformation, show evidence of their breeding, and give promise of high production.

The Jersey Bull Association was organized a little less than 2 years ago. Its territory was divided into 4 breeding blocks, and a registered bull of excellent breeding was purchased to head the herds in each block. All the bulls have Register-of-Merit dams. The average production of the 4 dams at the age of 2 years was equivalent to 509 pounds of butter in a year. When the cow-testing association furnishes the figures, as it will in about 2 years, it will be very interesting to compare the records of the daughters with those of their dams.

The members of both bull associations are very enthusiastic over the results so far achieved. The following are some of the remarks made by members: "I thought my bull pretty good until the bull association came." "My cows are not good enough to breed to that bull. I must have better cows." "I lost a year by not having a good bull sooner."

Many of the members of the bull associations have purchased pure-bred cows and the cows and bulls are so selected that constructive breeding is being conducted along definite lines. In the community more than 40 pure-bred herds have been established within the last year.

THE GROVE CITY GUERNSEY BREEDERS' ASSOCIATION.

The Guernsey breeders at Grove City organized in March, 1917. At that time the 18 charter members owned only 10 registered Guernseys, the most of which were bulls used in the improvement of their grade herds. To-day the association consists of 28 members, owning 71 registered Guernseys, and every member owns, either outright or jointly, a carefully selected registered sire.

All members are required to have their herds tested under the accredited-herd plan. On July 15, 1918, they adopted the following resolution: "Any person to be eligible to membership in the Grove City Guernsey Breeders' Association must either already have had his herd tested under the accredited-herd plan or have his herd signed up for the accredited-herd plan."

TUBERCULOSIS-FREE ACCREDITED DAIRY HERDS.

The dairy farmers in the Grove City community are determined that tuberculosis shall not exist among their herds. More than 100 herds in the vicinity have been signed up already under the accredited-herd plan and many of them are now being tested. So far few diseased animals have been found.

Under the accredited-herd plan the State and Government veterinarians test the herds annually free of charge to the owners. After a herd has passed two annual or three semi-annual tuberculin tests, the owner receives a certificate from the State and Government showing that the herd is accredited as free from tuberculosis. This guarantees to the owner and to the public that, so far as science can determine, the herd is free from that disease. At the present time three State and Government veterinarians are engaged in this work in the Grove City district.

For a while at first there was some objection to the test, and in some of the outlying districts there may still be some who object to it. One farmer remarked, "Some of my neighbors were kind of pitying me, that I didn't have any more sense than to have my herd tested." His herd was tested and found free of tuberculosis. The owner considers that every animal in the herd is worth 25 per cent more than it was before the test. This farmer was especially pleased.

that the calf belonging to his 14-year-old boy was free from tuberculosis. The boy is a wide-awake member of the calf club, and in 1917 his calf, in competition with many others, won first prize at the Stoneboro fair.

BOYS' AND GIRLS' CLUB WORK.

The Boys' and Girls' Pure-bred Dairy Cattle Club was organized more than a year ago with 53 members. Every boy and girl has stuck to the work, and of the young people growing up in that community at least this number have an added interest in farming because of the existence of the creamery in Grove City.

The boys and the girls, too, are very proud of their calves. They have learned to feed them balanced rations and to give them sanitary surroundings. It is quite evident that in some cases at least the calves belonging to the club members have been the direct cause that brought about the remodeling of old barns. Parents naturally take pride in the constructive work of their children, and in the Grove City district the children have not lacked home encouragement in their club work. In addition to the dairy-cattle club there are pig clubs, garden clubs, canning clubs, and a club recently organized under the direction of the county agent and known as "The Young Farmer Club," to belong to which one must have won a prize in some "worth-while" contest.

The Boys' and Girls' Pure-bred Dairy Cattle Club was not organized for a single season nor to see how much cash profit could be made from buying calves in the spring and selling them in the fall. It is a long-time proposition, and is educational in its design. The real contest will reach its point of greatest interest when the heifer calves become cows and the members of the club compete in feeding for highest economical production.

DAIRY BUILDINGS IMPROVED.

In spite of the war and the high cost of building materials, the last year has seen the construction of 25 new silos and 57 old barns carefully and thoroughly remodeled. The remodeling of old barns has usually been done at slight expense. Concrete floors were laid in 25 dairy barns, up-to-date stanchions were placed in 19, and more and larger windows

increased the lighting capacity of 50. Dairy development has come so rapidly that many dairymen have had to keep their dairy cattle in barns that never were constructed for that purpose. The wisdom of using these old barns is evident, because it has allowed the dairymen to use more of their capital in the purchase of high-producing dairy cattle.

RIVALRY IN CLEAN MILK PRODUCTION.

With modern sanitary barns and with herds free from disease, the dairymen of Grove City have begun to take pride in furnishing the creamery with milk and cream of low bacterial count. To do this they are beginning to sterilize the milk utensils, use the small-top milk pail, cool the milk promptly, and keep it cool until it is delivered at the creamery.

The creamery is encouraging a spirit of rivalry among the dairymen in connection with the production of clean milk. When one farmer improves the sanitary condition of his barn and milk house, near-by farmers are influenced to do the same. A field man is now employed to instruct and encourage the dairymen in the production of clean milk. By means of demonstrations he teaches them the best methods of sterilizing milk utensils, the kind of small-top pail to use, and the quickest and best way to cool the milk. Most dairymen take pride in their work and they are ashamed to have the milk returned to them from the creamery as unsatisfactory.

For cooling the milk, cold spring water is available on most farms and some of the farmers now put up ice enough to last all summer. That the spring house for cooling the milk may be conveniently situated, the spring water is sometimes piped to a considerable distance from the spring. To economize in the construction of buildings, ice is frequently stored in buildings that were intended for other purposes.

DAIRY-CATTLE SHOW AND SALES ASSOCIATION.

An organization known as the "Grove City Federal and State Accredited Dairy Cattle Show and Sales Association" was effected August 3, 1918. Its stated object is "to encourage the development of healthy herds, and for exhibition, advertisement, and sale of dairy cattle."

The constitution requires that each member "shall have his entire herd of dairy cattle under the supervision of the Pennsylvania State Live Stock Sanitary Board and the United States Bureau of Animal Industry, for the establishment of tuberculosis-free accredited herds." It also requires that each member "shall deal honestly and squarely, and never misrepresent an animal that he offers for sale or exchange." Each member is required to furnish the secretary-treasurer with an extended pedigree of all animals he offers for sale or exchange. He may obtain such pedigrees through the association at 50 cents each.

COMMUNITY HOLDS ANNUAL PICNIC.

Once a year the people of the community hold a picnic and dairy-cattle show. A year ago the attendance was about 800, and this year more than 1,500 were present. The exhibit of Holsteins, Guernseys, and Jerseys was excellent and attracted visitors from all over that part of the State as well as some from other States.

After the picnic lunch the audience listened to a very interesting and instructive program in which the speakers took up many local problems and offered many practical suggestions. The most valuable part of the picnic, however, was that it brought the people together. This getting together once a year, from the whole countryside, has a broadening influence on the development work.

ORGANIZATION AND SYSTEM WELL DEVELOPED.

Although Grove City is a town of only about 4,500 inhabitants, it has large manufacturing interests and a successful college. It is significant that it has never had a saloon. That the community is well organized is shown by the following list of local associations:

- The Commercial Club.
- The Creamery Patrons' Association.
- The Cow-Testing Association.
- The Holstein-Friesian Bull Association.
- The Jersey Bull Association.
- The Guernsey Breeders' Association.
- The Boys' and Girls' Pure-bred Dairy Cattle Club.
- The Young Farmer Club.
- The Federal and State Accredited Dairy Cattle Show and Sales Association.

In addition to the organizations mentioned above, the First National and the Grove City National Bank, the Ladies' Auxiliary of the Commercial Club, the men connected with the creamery, and the farm bureaus of Mercer, Butler, and Lawrence counties are all assisting in every way possible to make the community-development work a success. The people of the community have learned to pull together for a common cause, and it has paid them well. Last year the deposits of one of the banks increased \$435,000, and upon careful analysis it was found that at least \$150,000 of this came from the improved agricultural conditions, most of which were due to dairy-development work. The many business firms of the city have felt the effects of the movement in their greatly increased business.

The creamery has gained a reputation for high quality of products. This has brought a ready market at satisfactory prices. Such prices have encouraged larger production and the combination of increased production and satisfactory prices has made the farmers more prosperous. Successful farming depends as much on markets as on large production, and the creamery has brought the market.

The creamery is quite diversified and turns out many different dairy products and by-products. At a small cost for additional equipment it is now prepared to manufacture what the market demands at any particular time. This helps much in the marketing, especially in the marketing of by-products. The sales of cottage cheese, buttermilk, condensed skim milk, and other by-products of buttermaking have added to the gross income and have helped materially in increasing net profits.

Increased financial prosperity, however, is only a small part of the gain that has come to the community. Better schools, better churches, better homes, and better social conditions are coming as a result of the increased prosperity, because the people have learned to work together without friction.

With so many organizations working together, and with so much work undertaken and rapidly accomplished, it is quite evident that back of it there must be some guiding hand. Back of the community development work in the Grove City

district, watching every move, helping where help is most needed, giving a word of encouragement here and heading off an approaching controversy there—back of all this stands the creamery field man. He is employed by the Dairy Division to look after this work, and any community that is ambitious to do what the Grove City community has done will do well to employ such a man to look after the details of the field work and to encourage a spirit of helpful cooperation. In this work the field man has the cooperation and assistance of the county agent as well as of the men in charge of the creamery.

In the Grove City community the farmers are constantly calling on the field man to help them select their breeding stock, to direct the remodeling of their dairy barns, to arrange for the tuberculin testing of their dairy herds, to find hired help for them in busy times, and to assist in the solving of farm problems of various kinds.

The field man is one of the busiest men in the community, and the only way he can carry on his work at all is by getting everybody to work with him, as all in the Grove City community are glad to do. At present his salary is paid by the United States Department of Agriculture, because the plan is still in the experimental stage; but many of the leading men in the Grove City community are fully convinced that it would be the best kind of investment to pay his salary out of local funds rather than lose his services from the community.

Inquiries received from various parts of the country indicate that many other communities are considering development work similar to that now in progress in the Grove City community. It is not necessary that the development work should be in dairying, as the Grove City plan can be adapted as well to any other type of agriculture.

To make the work a success, however, the community must cast aside all selfishness, pull together, and organize, and should select for its field agent a man of personality, education, ability, and diplomacy. The man who can guide such work must be thoroughly trained in scientific and practical agriculture; he must have had wide experience; and he must be a man of considerable diplomacy. With such a man in

charge there is every reason to believe that any community, with even fair agricultural resources, can do what the Grove City community has done.

FARM HOMES REFLECT PROSPERITY.

Though successful dairying has done much toward the improvement of the Grove City community, the work seems only at its beginning. Three years of progress have brought many improvements. An addition to the creamery is now being constructed that will more than double its capacity. Many barns are being remodeled. Dairy herds are being rapidly improved through selection and constructive breeding. Farms are becoming more productive through soil improvement, due to dairying. Many farm houses are now equipped with electric lights, running water, and other conveniences. A beginning has been made in road improvement. Cooperation is evident everywhere; a spirit of confidence prevails and, doubtless, what has been so well begun will be carried forward to still further success.

THE PLACE OF RYE IN AMERICAN AGRICULTURE.

By CLYDE E. LEIGHTY,

*Agronomist in Charge of Eastern Wheat and Rye Investigations,
Bureau of Plant Industry.*

GREAT INCREASE IN RYE PRODUCTION.

RYE is receiving more attention in the United States now than ever before. More acres and more bushels of rye were harvested in 1918 than in any previous year in the history of the country. Since 1914 there has been a steady annual increase in rye acreage, so marked in extent that in 1918 the acreage harvested was more than double that of 1914. More attention is being given to the rye crop by agricultural colleges and experiment stations. At many of these institutions, investigations of the rye crop are being enlarged or started anew, and rye is being recommended to farmers as a safe and desirable crop more frequently than ever before. More rye flour is being eaten in the homes of America, but no rye at all is being made into alcoholic beverages.

A prediction a decade ago that in 10 years the United States would produce one-tenth as much rye as wheat would have been considered bold indeed, and few would have seen any sound basis for such a forecast, for rye has never had a prominent place among the crops of this country. In a few States, it has been grown rather largely, but never so far as records show has it been the most important crop in any State.

In the last few years large increases in rye sowings have occurred in parts of the country where its desirability, due to special reasons of adaptation, is being recognized. This increase is being favored by higher prices for the grain than formerly. But it is probable that once it becomes a familiar crop and the advantages that it possesses are recognized, it will have a permanently larger place in our agriculture.

The production of rye and wheat in the United States in the census years from 1849 to 1909, given in the accompanying table, shows that only a little more than twice as much rye

was produced in 1909 as in 1849, while for 1889 and 1909 the productions vary by little more than a million bushels, or less than 4 per cent. In the 60 years from 1849 to 1909, the wheat production increased more than sixfold, and in the 20 years, 1889 to 1909, about 45 per cent.

Production of rye and wheat in the United States in census years, 1849 to 1909.

Year.	Rye production.	Wheat production.
	<i>Bushels.</i>	<i>Bushels.</i>
1849.....	14,189,000	100,486,000
1859.....	21,101,000	173,105,000
1869.....	16,919,000	287,746,000
1879.....	19,832,000	459,483,000
1889.....	28,421,000	468,374,000
1899.....	25,569,000	658,534,000
1909.....	29,520,000	683,379,000

The population of the continental United States increased during the period 1849 to 1909 from 23,191,876 to 91,972,266, and from 1889 to 1909 the increase was 46 per cent.

Up to 1909, as indicated in these figures, our rye production was practically stationary, but since that time large increases have taken place. This is shown in the following table, where are given the wheat and rye production, in bushels, for the years 1909 to 1918 and the percentage of the 1909 crop produced in subsequent years.

Annual production of wheat and rye in the United States for the years 1909 to 1918 and percentage of the 1909 crop produced in each subsequent year.

Year.	Wheat.	Percentage of 1909.	Rye.	Percentage of 1909.
	<i>Bushels.</i>		<i>Bushels.</i>	
1909.....	683,379,000	-----	29,520,000	-----
1910.....	635,121,000	92.9	34,897,000	118.2
1911.....	621,338,000	90.9	33,119,000	112.2
1912.....	730,267,000	106.9	35,664,000	120.8
1913.....	763,380,000	111.7	41,381,000	140.2
1914.....	891,017,000	130.4	42,779,000	144.9
1915.....	1,025,801,000	150.1	54,050,000	183.1
1916.....	636,318,000	93.1	48,862,000	165.5
1917.....	650,828,000	95.2	60,145,000	203.7
1918 ¹	918,920,000	134.5	76,687,000	259.8

¹ October estimates.

In 1918 our crop was over 76,000,000 bushels, which is over 16,000,000 more than the previous largest crop, that of 1917. In the fall of 1917 the acreage sown to rye was increased 36.6 per cent over that sown for the crop of 1917. In 1918 we had approximately 1 acre of rye for each 10 acres of wheat. Only five years ago we had approximately 1 acre of rye for each 21 acres of wheat.

WORLD PRODUCTION.

The world production of rye amounts to about one and two-thirds (1.668) billion bushels. This is somewhat less than one-half the annual wheat production (3.61).—The leading countries (prewar boundaries) of the world in rye production are: Russia (European), where about one-half of the world's crop is produced, Germany, and Austria-Hungary. These three countries in 1913 produced 86 per cent of the world's rye crop.

RYE AND WHEAT COMPARED.

Rye and wheat are the only grains from which light bread can be made. Substitutes can be used, up to a certain point, but the basis of such mixtures must always be either wheat or rye flour. These two grains, therefore, are known as the bread grains. As such their place is second to none in importance among the foodstuffs of the world. Because of this interrelation, any consideration of rye must of necessity include comparison with and consideration of wheat.

The people of the world in general prefer wheat as a food and are more accustomed to it, as is indicated by the production of more than twice as much wheat as rye in the world. This preference seems very definite in such countries as the United Kingdom, France, and the United States. Part of the preference is doubtless due to the greater palatability of wheat bread and to the fact that wheat flour works up better and makes a better looking product when made into bread, cake, and pastry. But wheat is in general as well or better adapted than rye to large sections of these countries, or at least rye is not especially superior in large sections of these countries. On the other hand, Germany, Russia, and other northern countries of continental Europe produce and use much more rye than wheat. This, in turn, is due in part at

least to rye being better adapted to the soil and climate and more reliable as a crop in these countries; the people also doubtless like the taste of rye bread and value it as a food.

MORE RYE SHOULD BE GROWN.

From an agricultural point of view there is need for considerable increase in the production of rye in this country, not only from the standpoint of our present unusual food situation, but also from the standpoint of practical farming. In many localities rye should replace wheat, as it will give better yields and more food per acre than wheat. In other localities not now growing any bread grain, rye can be grown to advantage where wheat would not succeed. These facts are being recognized by farmers, who realize that, since the necessity exists for producing large amounts of bread grains, there should be no waste of seed, labor, or land. The speculative risk in growing wheat in certain sections is being recognized as too great, and in some of these it is being recognized that the growing of rye is not attended with such risks.

It is generally recognized, for instance, that rye is hardier than wheat. The large sowings of winter rye and small sowings of winter wheat in North Dakota abundantly testify that this is a fact. In South Dakota, also, the only winter grain hardy enough to withstand without protection the winter conditions throughout the State as a whole is rye. Winter wheat must have winter protection in most of the State.

Of course, spring wheat can be grown in all this part of the country. But there is greater risk with spring wheat than with rye. First, the spring season may be unfavorable and the full acreage can not be put in, or can not be sown until the best time for seeding is past. Then there exists for wheat the annual threat of destruction by rust, hot weather, or a combination of diseases and unfavorable climatic conditions. What these agencies are capable of accomplishing is evident from the experience of the Dakotas and Minnesota in 1916, when the loss in the spring-wheat crop was estimated at over 180,000,000 bushels. In North Dakota that year the wheat yield was estimated as averaging 5.5 bushels, valued at \$8.36 per acre on the 7,150,000 acres

of the State. The rye crop averaged 13.3 bushels, valued at \$16.62 per acre on the 350,000 acres of the State. It is not surprising then to find the rye acreage in North Dakota amounting to more than a million acres sown in the fall of 1916 and amounting to $2\frac{1}{2}$ million acres sown in the fall of 1917.

In five States the estimated 5-year average (1912-1916) acre value for the rye crop is greater than for the wheat crop—these States being Alabama, Minnesota, North Dakota, South Carolina, and South Dakota. Several other States, especially in the East, would be included if the usually greater value of the straw as compared with wheat straw were also taken into account.

RYE BETTER THAN WHEAT FOR POOR SOILS.

The greater hardiness of rye is not the only reason for its being more valuable in certain parts of the country, nor even the principal reason why it should be preferred to wheat in certain localities and on certain parts of very many farms. Rye will produce profitable crops on some lands not adapted to wheat. On poor, sandy land, on land that is acid in reaction owing to lack of lime, and on land poorly prepared for receiving the seed, rye will usually yield better than wheat. Rye, therefore, should be sown more generally on the sandy lands along the lakes in Michigan, Illinois, Indiana, Ohio, and New York, and also in New Jersey, and generally in the coastal-plain regions of the Atlantic and Gulf. Wherever it is desired to grow a grain for breadmaking on such sandy lands, rye usually should have the preference. And on the acid lands, large areas of which are found in the eastern half of the United States, as in southern Illinois, in Missouri, in Pennsylvania, and elsewhere, rye is an excellent crop, able to withstand the acidity to good advantage and not requiring such large amounts of lime as wheat.

Some of the expense for fertilizers can be saved by growing rye instead of wheat. This is of especial importance at this time, when fertilizers are not sufficient in amount or for various reasons can not be secured readily by those who must apply them on other crops. As mentioned above, the expense of liming the land can be largely avoided

in growing the rye crop; and nitrogen also need not generally be applied. In fact, any considerable amount of nitrogen in the soil may cause lodging of the rye crop.

RYE HELPS DISTRIBUTE LABOR.

The growing of rye is an advantage in many parts of the country from the farm-management standpoint. In the spring-wheat regions it is sown in the fall, often on disked wheat stubble, and harvested before wheat is ripe, thus saving and distributing labor. In the winter-wheat areas it may be sown later than wheat, though very late sowing is not advisable. It may thus be sown when it is too late to put in wheat or after wheat sowing is completed, thereby often increasing the acreage that can be used for grain crops. Again, if the land can not be prepared in time for wheat, owing to rush of work, seasonal conditions, or because some late-maturing crop is occupying the land, rye may well be sown. Rye will germinate more quickly than wheat at low temperatures and will make more rapid early growth when the weather is cool. On the other hand, rye may be sown before wheat, as there is little danger of its being injured by the Hessian fly.

RYE IN THE COTTON BELT.

Increase in the production of rye is especially desirable in the Cotton Belt. This part of the country is being urged to produce more of the bread grains, so that the people may eat bread from home-grown grain. This is to insure a plentiful food supply close at hand and independent of railroad transportation. But it means to the farmer a greater profit and a safer, and therefore better, system of agriculture. The mistake must not be made, however, of attempting to grow crops unsuited to conditions.

There is much sandy land in this region. The soils are generally acid in reaction and fertilizers are widely needed. The climate often is unsuited to wheat. Under such conditions, rye may usually be grown successfully and with profit.

In experiments on the Sassafras loam soil near the southern boundary of Georgia, wheat yielded in a 3-year test an

average of 432 pounds per acre, while rye yielded 963 pounds per acre. In experiments some 50 miles farther north in Georgia, wheat returned in the same period 960 pounds per acre, while rye returned 1,310 pounds. These results show that preference should be given to rye rather than wheat in this southern part of the Cotton Belt.

In a large area of the country where the Hessian fly is a destructive pest, losses in certain years could be avoided if a part of the grain crop were rye instead of wheat. The region where the fly is worst also has much acid land on which rye is the better adapted crop.

BETTER GROWING CONDITIONS FOR RYE URGED.

On too many farms of the United States rye has been the "Cinderella" among crops. Often sown late in the fall, on the poorest land, with indifferent seed-bed preparation, it has not infrequently been given a poor chance to compete with other better-favored crops. It will respond to better treatment with increased yields and more profit. It should generally be sown earlier in the fall, and better seed-bed preparation and fertilization should be provided for it than is now the case.

RYE VARIETIES.

Rye is still known to many seedsmen and farmers only as "winter" rye, or occasionally as "spring" rye. Very little spring rye is grown in this country, as the winter form is adapted almost entirely and is more productive. Of winter rye there are, however, several varieties, most of which have within the recent past been imported from foreign countries or have been developed in this country from imported seed.

For a great part of the Cotton Belt, the Abruzzes (also spelled Abruzzi) variety, introduced from Italy by the United States Department of Agriculture in 1900 and 1904, has given remarkably good results on account of its rapid and vigorous growth, even in cold weather. It is very valuable for grazing and cover-crop purposes. It also produces good yields of grain. Yields of 30 bushels per acre under ordinary farming conditions are not unusual in the Cotton Belt. It is equally successful as far north as Washington, D. C., where, in comparative experiments, it has not been

exceeded in yield by any other variety tested. In the extreme southern portion of the Cotton Belt there is an excellent variety or varieties known locally as South Georgia, Beech Island, and Florida Black Seeded. When sown in this region, this native sort is several days earlier and somewhat taller than the Abruzzes variety, but has not yielded quite as much grain as the Abruzzes in comparative tests.

In the northern half of the Cotton Belt, the North Georgia and Virginia ryes give good yields of grain, but they are not as good as the Abruzzes variety for a pasture and cover crop, as the manner of winter and early spring growth is low and spreading.

Minnesota No. 2 rye was developed at the Minnesota Agricultural Experiment Station from several good plants selected from the Swedish rye. It was distributed in 1908. Other good varieties in Minnesota are Dean, Petkus, Schlanstedt, and St. John. The Dean and Swedish have given good results in South Dakota. In Wisconsin the Petkus (Wisconsin No. 1), Schlanstedt (Wisconsin No. 2), Ivanof (Wisconsin No. 3), and Dean (Wisconsin No. 4) have all given good results. All these varieties are undoubtedly well adapted for fall sowing in the spring-wheat region.

The Michigan Agricultural Experiment Station has recently introduced a variety known as Rosen, originated at the station by selection from an imported Russian variety. It is reported to give very good yields of grain in that State when grown on the lighter soils.

Other varieties of rye grown in the United States are Mammoth White, Giant Winter, Mexican, Rimpau, and Henry.

There are few marks by which rye varieties can be distinguished, and the varieties as they exist are generally not pure in respect to any of the characters by which possibly they could be distinguished. Rye is cross-fertilized, like corn, and therefore any variety is soon mixed with other varieties unless great care is exercised. All varieties of rye are awned. In some varieties more than others, the awns are more or less deciduous, falling off wholly or in part from many of the heads about the time of ripening.

UTILIZATION OF THE RYE CROP.

RYE AS A COVER CROP AND GREEN MANURE.

Rye is excellent for use as a cover crop and for green manure, to prevent washing of the soil and leaching out of the soluble plant foods. To be valuable for this purpose, a crop must make a large fall and winter growth when no crop otherwise occupies the land. Abruzzes rye in the South is excellent for this purpose, as it makes a very large and early growth which can be turned under early in February.

While rye does not have the ability to utilize the nitrogen of the air as do the legumes, it does have the ability to take up and store in its tissues a great deal of nitrogen from the soil. The amount taken up per acre by rye is sometimes larger than the combined amount taken up from the soil and from the air by some of the legumes. Nitrates that might be lost from the soil in winter are thus largely preserved by growing a cover crop of rye. Rye and vetch together make an excellent combination, vetch being a legume and rye producing a large amount of green material for plowing under. Hairy vetch is well adapted for this purpose, as it is winter hardy when sown with rye in all of the Northern States. A satisfactory combination is 20 to 30 pounds of vetch and 2 or 3 pecks of rye per acre. (For further information regarding vetch see United States Department of Agriculture Farmers' Bulletins 515 and 529.)

Other legumes, such as crimson or alsike clover, also can be grown with rye. Rye and barley or rye and buckwheat, each half and half, can be used for cover. Buckwheat and rye are sown early in July, the buckwheat being harvested for grain and the rye furnishing a cover over winter. When barley is used with the rye, the combination makes a heavy fall growth, excellent for pasture. In the Northern States, the barley is usually killed by cold weather, the rye alone remaining over winter.

When used as a cover or green-manure crop, rye should be turned under before it is fully mature. From the time it is knee-high until it begins to head is a favorable time. If allowed to grow too long it may reduce to practical exhaus-

tion the moisture and available plant foods in the soil. It also decays slowly in the ground when nearly mature, and therefore may injure the following crop. If the soil is too dry for plowing at the proper time, the crop may be double-disked twice, which will stop growth and prevent further drying out of the soil and may cause it to become mellow enough to plow in a few days, even without rain. Thorough disking and packing of the soil should always follow after plowing under a growth of rye, as this will hasten decay. An application of half a ton to a ton of lime or of 1 to 2 tons of fully crushed limestone will correct the acidity caused by the decay of the green material. Lime should generally not be applied if potatoes are to be planted.

RYE AS A NURSE CROP.

In many sections, rye is very good for use in seeding down land to grass and clover. On sandy land and along the northern limits of the region where wheat can be produced successfully, rye is especially desirable, as it does better than wheat in those locations. It is extensively used on the sandy soils of Michigan for this purpose. Rye also shades the ground less and for a shorter time than some of the other small grains used as nurse crops.

RYE AS A SOILING AND SILAGE CROP.

Rye is a valuable soiling crop in many States. It yields well and is ready for use early in the spring when pastures are too young and other feeds are generally scarce. In all except the most northern regions, it is ready for use on or before May 1, which is earlier than any other crop that is suitable for soiling purposes. A large leaf growth is desirable when the crop is to be so used. This can be secured by the use of the proper variety, by manuring and fertilizing heavily, by the use of proper cultural methods, and by early fall seeding. A variety that has been grown for several years in a locality and that produces good yields of grain and straw should be suitable for soiling purposes.

Cutting and feeding the crop should begin when the plants show the first heads, as the feed is then available over a period of 10 to 20 days, while if cutting is delayed the feed-

ing period is less. The available time for feeding may be lengthened by making several seedings in the fall at intervals of two or three weeks. An acre of rye should yield from 4 to 12 tons of green material, averaging about 7 tons.

Dairy cattle relish green rye, and its use generally results in an increased flow of milk. If feeding begins when the first heads appear, only about 30 pounds should be fed daily to a 1,000-pound cow. This amount may then be increased gradually to 50 or 60 pounds on the third day. If the flavor of the milk is injured, the length of time between feeding and milking should be increased. A ton of green rye contains about 43 pounds of protein, 192 pounds of carbohydrates other than crude fiber, and about 86 pounds of crude fiber. A ton of wheat bran contains about 300 pounds of protein, 1,080 pounds of carbohydrates other than crude fiber, and 180 pounds of crude fiber. The carbohydrates and also the crude fiber are more digestible in the rye than in the bran. An average acre of green rye, therefore, will furnish somewhat more food material than a ton of bran.

Rye makes silage of fair quality if cut when the grain is in the late milk stage. It should be cut rather fine and well tramped in the silo, to force as much air as possible out of the hollow stems. It is not as good for milch cows as corn silage.

RYE AS A PASTURE CROP.

Rye is the most suitable of the cereals for general use as a pasture crop. Winter rye should be used generally for this purpose, either alone or in combination with some other crop, such as vetch or crimson clover. It makes considerable fall growth and can be used for late fall pasture. Where the winters are not too cold and the proper variety is used, the plants will grow upright and therefore can be grazed easily by stock. It is more cold resistant than any of the other cereals that have upright growth, and will therefore remain green where others would be partially or wholly killed.

Calves, sheep, and hogs can be pastured on winter rye more advantageously than large animals, as they do not tramp the ground so much. By sowing about 2 bushels of seed per acre early in the fall on well-fertilized land and then pasturing until time to plow for corn, much vegetable matter

is added to the soil, and so many weeds are killed by the pasturing and plowing that the corn can be kept clean with less work.

The same methods should be employed in growing rye for pasture alone as are employed when growing it for a soiling crop. A heavy application of manure and fertilizer will result in more pasturage being produced, and the extra seed sown will result in a good stand.

Rye grown as a cover or green-manure crop may be pastured if desired. Rye intended for grain may be pastured judiciously until it begins to head out in the spring. It should not be pastured when the land is wet, as the tramping of the stock is injurious, and it should not be pastured too closely at any time. If sown too early in the fall, rye, like other cereals, may joint before cold weather begins, in which case it will be killed. Pasturing in such a case will prove beneficial in preventing too forward a growth.

Rye used as pasture for milch cows generally results in an increased flow of milk. Any injurious flavor resulting in the milk may be avoided largely or wholly by allowing the cows to graze on it for only two or three hours just after milking.

RYE GRAIN AS FEED.

Rye grain is not popular as a feed for animals and never will replace oats, barley, and corn for this purpose. The average total digestible nutrients in rye grain are: Protein, 13.91 per cent; fat, 1.85 per cent; carbohydrates, 79.85 per cent; and crude fiber, 2.34 per cent. If rye can be produced more economically than any of the other grains, and it is necessary to feed the grain, it should be fed with such feeds as bran and oats in order to lighten the sticky mass formed during mastication. Rye should not form more than one-third of the ration, and should never be fed in large quantity nor alone. As a feed for hogs, rye grain fed as a thin slop in combination with skimmed milk has about the same value as barley grain so fed. Neither barley nor rye is as good for fattening as corn, but the quality of pork produced is better. Rye shorts is not a satisfactory hog feed. Rye may be fed to work horses, using from 2 to 4 pounds daily in addition to other grain. Some who have fed rye grain

to horses advise that it be rolled or bruised and well mixed with cut straw and that it be added to the ration gradually at first, or colic will result. Ground rye or rye bran may be fed to milch cows, from 2.2 to 3.3 pounds being used daily in connection with other feed. Rye grain is a poor feed for poultry.

Varying amounts of rye and rye flour are exported, the percentage of the crop so disposed of ranging from less than 1 per cent in some years to more than 50 per cent in others.

USE OF RYE IN DISTILLING.

Prior to the outbreak of the European war an average of about 5½ million bushels of rye was used annually in distilling, while practically none was used in brewing. This was 15.6 per cent of the crop and represented the produce of about 320,000 acres. For the three years subsequent to the outbreak of the war and before restrictions were placed on the use of rye, the average quantity used annually in distilling was 2,644,203 bushels, or 5.4 per cent of the crop. In the year ended June 30, 1918, only 248,864 bushels of rye were so used, owing to food-conservation regulations. The production of rye in 1918 was nearly 34,000,000 bushels larger than that of 1914. Rye flour has been eaten more than ever before in the American home, for our exports in the last five years have been about 12 to 15 million bushels annually, or much less than the increase in production.

STORING AND MARKETING THE GRAIN.

It is rather difficult to keep rye in good condition unless it is thoroughly dry before storing. If damp when stored, it becomes hot and musty. With the possible exception of barley and the grain sorghums, no grain acquires a musty odor quicker than rye, and no amount of shoveling or handling will completely remove the odor when it is once present. If rye grain is thoroughly dry before storing, or, better still, before thrashing, and is stored in cool, well-ventilated bins, it can be kept without difficulty.

In marketing rye, care should be taken to have it sweet and clean, of good color, and as free as possible from dirt, chaff,

weed seeds, and other grains. It is especially important that rye be free from wild onion or garlic, as otherwise it will be discounted heavily in price. The legal weight of rye is 56 pounds per bushel.

USES OF RYE STRAW.

Rye straw is valued highly for bedding horses, for packing furniture, crockery, and nursery stock, and for manufacturing purposes, especially for stuffing horse collars. It is also used in a limited way for drinking straws. Special means are often employed in thrashing to preserve the straw straight and unbroken. To obtain the best prices, the straw must be long, bright, and clean.

A brighter straw usually is obtained when it is grown on uplands rather than in valleys or on low-lying black soil. On the lowlands and black soils it is more likely to be damaged by wet weather. Brighter and heavier straw is obtained by cutting a few days before it is fully ripe.

Mature rye straw is not so suitable for feeding purposes as straw from other cereals, especially that from oats and barley. It is tougher and less digestible and contains a smaller amount of nutritive matter. It is nevertheless frequently used for feeding in places where it is grown.

MARKETING RYE STRAW.

Rye straw in neat square-ended bales loads into cars better and, other things being equal, commands higher prices than when the bales are shaggy and rough in appearance. Bales are made in different sizes, but one of the best is 4 feet in length, tied usually with five wires 7.5 feet long, and weighing about 200 pounds. Such a bale is made by using the old-style open-topped box press rather than the end-pack press commonly used for hay and straw. The bundles of straw as they come from the thrasher are packed in the box by stepping on each one as it is placed, and folding over the head end. When the box is full the top is clamped on and the pressure applied from below. For best results the bundles should be rather small. Only well-cured bright straw is worth baling. About 10 tons of baled straw make a carload.

CAN THE INCREASED RYE PRODUCTION BE MADE PERMANENT?

The principal barrier to the increase of rye growing in the United States has been the preference of the people for wheat products, coupled with the always sufficient or even abundant supplies of wheat. There has been also a lack of acquaintance with the rye crop on the part of both producer and consumer. Farmers have continued to grow wheat, even where rye would have been more profitable, because they did not know its adaptation or value and because seed was not readily available and the market for the crop was not sufficient.

Many people of this country in recent months have been getting acquainted with rye. For a long time we, as a people, have been accustomed to a "ryeless" diet. But with "wheatless" meals and "wheatless" days as national necessities, we have been glad to find in rye an acceptable substitute. The wheat consumption of the country in the past has been each year about 380 pounds for each person, while for rye it has been only about 20 pounds. In the past year more rye and less wheat than formerly were eaten.

Rye flour makes a wholesome nutritious bread, somewhat heavier and darker than that from wheat flour, the color probably being due to the darker gluten it contains. The dough from rye flour often becomes too soft and falls or becomes soggy. To correct this, wheat flour equal to one-fourth to one-half the quantity of rye flour is often added. The addition of the wheat flour improves the qualities of the dough, that from rye flour alone being very sticky and difficult to handle. Wheat and rye flour can be and are, of course, mixed in any proportion for baking.

How far the preference for wheat may be permanently overcome by the conditions incident to the war it is impossible to say. Many of the theories and practices regarding food have been upset, and it may be that a permanent change will take place in relation to rye as a food. Definite steps in this direction have already been taken by large numbers of people, and behind the change are some sound economic, as well as agronomic, factors.

Desirable varieties of rye have been developed and are being distributed widely. Knowledge of the crop is being gained by farmers who did not know it a few years ago. People are learning to use rye as an article of diet. If they will only continue and increase their use of it, the greatest and most potent obstacle to the increase of rye production in the United States will have been removed, and the consumers will be assisting in establishing a system of agriculture better suited to the country and productive of a greater quantity of foodstuffs on the present cultivated acreage.

HOME MIXING OF FERTILIZERS.

By C. C. FLETCHER,

Scientist, Investigation of Fertilizer Resources, Bureau of Soils.

WHAT ARE COMMERCIAL FERTILIZERS?

COMMERCIAL FERTILIZERS are usually mixtures of materials containing nitrogen, phosphoric acid, and potash. These so-called complete fertilizers may be bought ready-mixed, or the ingredients may be bought and mixed at home. Very much greater quantities of the factory-mixed goods are sold in this country, but the practice of home mixing is growing, especially among large users and farmers' organizations.

The reasons are easily found. Home-mixing is usually very much cheaper, and many times it is better. The farmer not only learns more about fertilizers, but he is certain of what he is using. Especially, in many cases, it is important to know what form of nitrogen is used. For example, for some crops a quick-acting nitrogen carrier is essential; for others a slow-acting one, becoming available gradually throughout the season, is better. The home mixer can purchase nitrate of soda or ammonium sulphate and be certain that he is using high-grade materials, but in factory goods the nitrogen is not always in the form wanted.

It has been urged that factory goods are better mixed, easier to obtain, and represent higher skill in compounding, but all these objections to home mixing are readily overcome.

Undoubtedly home mixing is a good thing for the farmer, both financially and educationally, and should be encouraged. Where only a small amount is to be bought, it is more convenient to buy complete mixtures, and this course may also be best for the man who is not in position to study the subject. Home mixing, however, has proved successful in all parts of the country.

The materials commonly used are given in the following table:

Composition of the principal commercial fertilizing materials.

Fertilizing material.	Nitrogen.	Phosphoric acid.	Potash.
	<i>Per cent.</i>	<i>Per cent.</i>	<i>Per cent.</i>
Supplying nitrogen:			
Nitrate of soda.....	15.5 to 16.0		
Sulphate of ammonia.....	19.0 to 20.5		
Dried blood (high grade).....	12.0 to 14.0		
Dried blood (low grade).....	10.0 to 11.0	3.0 to 5.0	
Concentrated tankage.....	11.0 to 12.5	1.0 to 2.0	
Tankage (bone).....	5.0 to 6.0	11.0 to 14.0	
Dried fish scrap.....	7.0 to 9.0	6.0 to 8.0	
Cottonseed meal.....	6.5 to 7.5	1.5 to 2.0	2.0 to 3.0
Castor pomace.....	5.0 to 6.0	1.0 to 1.5	1.0 to 3.0
Calcium cyanamid.....	19.0 to 22.0		
Supplying phosphoric acid:			
Ground bone (raw).....	2.5 to 4.5	20.0 to 25.0	
Acid phosphate.....		12.0 to 16.0	
Basic slag.....		17.0 to 18.0	
Raw ground phosphate rock.....		26.0 to 35.0	
Supplying potash:			
Potassium sulphate.....			48.0 to 52.0
Potassium muriate.....			48.0 to 52.0
Kainit.....			12.0 to 12.5
Kelp ash.....			30.0
Nebraska potash salts.....			22.0
Wood ashes.....		1.0 to 2.0	2.0 to 8.0
Dried sheep manure.....	1.51 to 3.09	0.95 to 2.50	0.33 to 2.24

PURCHASING FERTILIZER MATERIALS.

In the purchase of materials good business judgment should be used. Wide competition should be sought and prices procured not only from local merchants but from large fertilizer firms in the home State and adjoining States. Lists of firms may be obtained from the State experiment station director and the Federal Department of Agriculture. Buy for cash to get best prices. Buy well in advance. This not only insures a better price but permits the use of farm labor in the winter when it is often not occupied profitably. Home mixing may be done in the barn when the weather is too inclement for outside work.

MIXING COMMERCIAL FERTILIZERS.

The mixing of the materials is comparatively simple. Any tight floor or a wagon box may be used and tools at hand may be employed. The materials are spread in layers, usually the most bulky first, and thoroughly shoveled together. The mixture is passed through a screen, and any lumps broken up with a tamper or the back of a shovel. The author uses a very large long-handled mortar hoe for mixing, and some will find this a convenient tool, but its purchase especially for this purpose is not necessary. Where large amounts are to be mixed it would probably pay to buy a small rotary mixer such as is sold for concrete mixing on the farm. The mixing should be continued until the material is fine and uniform, and then it may be bagged and stored in a dry place until used.

To avoid caking and losses, certain ingredients should not be used together in the same mixture, and the following diagram will give this information:

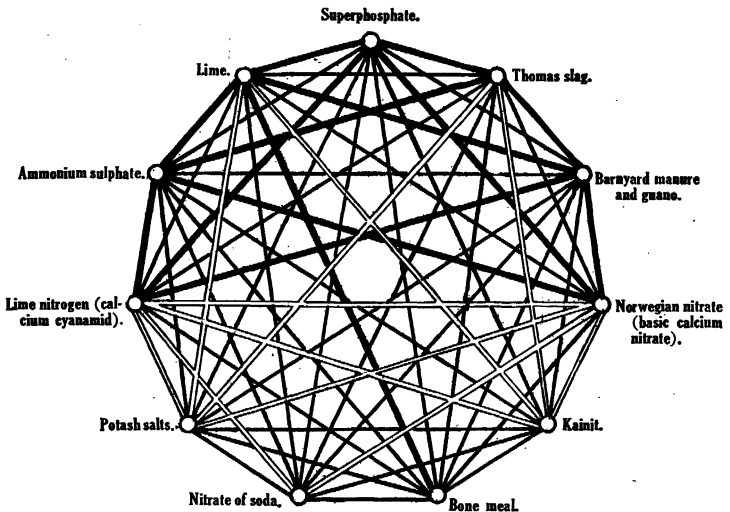

FIG. 3.—Diagram indicating what fertilizer materials may and may not be safely mixed. The dark lines unite materials which should never be mixed, the double lines those which should be applied immediately after mixing, and the single lines those which may be mixed at any time.

One of the easiest ways to start home mixing is to duplicate a formula already in use. A beginner should take a mixture which has been successfully used on the crop he is

raising on similar soil, get a price on the mixed goods, and then see what a home mixture of similar composition will cost.

The following table will help in calculating home mixtures. In making ton lots, to get 1 per cent, use amounts shown in first column; for 2 per cent, used the second column, and so on.

Quantities of fertilizer ingredients to be used to give definite percentages in a ton of mixture.¹

Ingredient.	1 per cent.	2 per cent.	3 per cent.	4 per cent.	5 per cent.	6 per cent.	7 per cent.	8 per cent.	9 per cent.	10 per cent.
Carriers of nitrogen (N):										
Nitrate of soda (15 per cent N).....	Lbs. 133	Lbs. 266	Lbs. 400	Lbs. 532	Lbs. 666	Lbs. 800	Lbs. 933	Lbs. 1,066	Lbs. 1,200	Lbs. 1,333
Sulphate of ammonia (20 per cent N)....	100	200	300	400	500	600	700	800	900	1,000
Cottonseed meal (7 per cent N).....	285	571	856	1,142	1,428	1,714	2,000
Dried blood (10 per cent N).....	200	400	600	800	1,000	1,200	1,400	1,600	1,800	2,000
Phosphoric acid carriers (P ₂ O ₅):										
Acid phosphate (12 per cent P ₂ O ₅).....	166	333	500	666	833	1,000	1,166	1,333	1,500	1,666
Acid phosphate (14 per cent P ₂ O ₅).....	142	285	428	571	714	856	1,000	1,142	1,285	1,428
Ground bone ² (23 per cent P ₂ O ₅).....	87	174	261	348	435	522	609	696	783	869
Potash carriers (K ₂ O):										
Potassium sulphate (50 per cent).....	40	80	120	160	200	240	280	320	360	400
Potassium chloride (50 per cent).....	40	80	120	160	200	240	280	320	360	400
Kelp ash (30 per cent K ₂ O).....	66	133	200	266	333	400	466	533	600	666
Nebraska lakes potash (22 per cent)...	90	180	270	360	450	540	630	720	810	900

¹ Where the combined materials do not total 2,000 pounds a filler may be used to bring up the mixture to that weight.

² Ground bone also carries nitrogen.

Example: To make up a 2-8-2 mixture using acid phosphate, nitrate of soda, and potassium sulphate, use 266 pounds of nitrate of soda, 1,142 pounds of 14 per cent acid phosphate, 80 pounds of sulphate of potash; total 1,488 pounds; make up total of 2,000 pounds with 512 pounds of ground limestone, dried peat, or muck or sand. Like the

fertilizer ingredients themselves, any filler used should be fine and dry.

A 4-7-10 mixture of the same materials would call for 532 pounds of nitrate of soda, 1,000 pounds of acid phosphate, and 400 pounds of potassium sulphate; total 1,932 pounds; add 68 pounds of filler to make up to 2,000 pounds.

The simple formulas following have been recommended:

	Pounds.
Cottonseed meal	1, 000
Acid phosphate (14 per cent)	1, 000
Total	2, 000
Approximate analysis, 3 per cent nitrogen (N), 7 per cent phosphoric acid (P_2O_5), and 1 per cent potash (K_2O).	

The foregoing sometimes is recommended as a general fertilizer where quick action is not essential.

	Pounds.
Acid phosphate (14 per cent)	1, 000
Ground bone	1, 000
Total	2, 000
Approximate analysis, 18 per cent P_2O_5 and 1 to 2 per cent N.	

This, as is seen, contains no potash and only a small amount of nitrogen. For clay soils rich in potash where plenty of manure has been used, the foregoing mixture will be found good.

	Pounds.
Nitrate of soda	200
Sulphate of ammonia	200
Fish scrap	400
Acid phosphate	1, 000
Sulphate of potash	200

The approximate analysis of above material is 5 per cent nitrogen (N), 8 per cent phosphoric acid (P_2O_5), and 5 per cent potash (K_2O).

This is a good garden fertilizer having nitrogen in differing degrees of availability.

MAKING A FERTILIZER FORMULA.

A general rule to use in making up formulas is first to decide what percentages are required, and then what materials shall be used. Start with the phosphoric acid (P_2O_5). Acid phosphate is almost universally used for this. With 12-per cent goods and 8 per cent of phosphoric acid desired in the mixture, the reasoning would be as follows: If the whole

mixture were acid phosphate, it would contain 12 per cent; as 8 per cent is desired, we take eight-twelfths or two-thirds of the mixture of acid phosphate or 1,222 pounds; if 6 per cent were wanted we would take six-twelfths or one-half or 1,000 pounds in a ton. Similarly with nitrogen. If nitrate of soda contains 15.65 per cent of nitrogen, and we want 2 per cent of nitrogen, $2/15.65$ or approximately one-eighth of the mixture or 250 pounds in a ton will be the amount.

Similarly with potash. If we have Nebraska potash salts carrying 22 per cent of potash, and desire 2 per cent in the mixture, we put in two twenty-seconds or one-eleventh of this material, giving approximately 182 pounds, in 1 ton.

Any other material may be used in a similar manner. It is not necessary to be exact down to the fraction of a per cent, as fertilizer application is not an exact science, and a slight variation in the calculation will not cause any loss, usually, in the agricultural value of the mixture.

PROFITS FROM HOME MIXING FERTILIZERS.

It is difficult to give an exact estimate as to the profits to be expected from home mixing. In normal times these have been usually from \$5 to \$15 per ton less in high-grade formulas than in the lower grades. It is always profitable, however, the saving usually being substantial. A retail price, for example of a 2-8-2 mixture quoted farmers in January, 1919, at Washington, D. C., is \$52 per ton. Acid phosphate can be purchased in the same locality for \$22 per ton, Government nitrate of soda for \$81 per ton, plus freight, and potash for \$4.25 per unit in large lots.¹ At these figures, the phosphoric acid in a ton of home-mixed fertilizer would cost less than \$15, the nitrogen \$10.25, and the potash \$8.50, a total of \$33.75, a difference in favor of home mixing. If we allow \$3.25 a ton for mixing and other charges, the saving is \$15 a ton. Each extra unit of potash will cost only \$4.25 as against \$6 charged the farmer by the dealer, the nitrogen also being obtained for less per unit than the dealer charges. An extra 3 per cent of potash, bringing the formula up to 5 per cent, will increase the profit per ton for home mixing \$5.25.

¹ A unit is 1 per cent in 1 ton, or 20 pounds. For example, potassium sulphate has 50 units of potash and sodium nitrate approximately 15 units of nitrogen.

LESS CHOLERA—MORE HOGS.

By O. B. HESS,

Office of Hog-Cholera Control, Bureau of Animal Industry.

HOG-CHOLERA CONTROL WORK.

WITHOUT yielding to undue optimism, it is pleasing to note that losses from hog cholera in the United States are on the decline. They have become less year by year since 1913, when Federal control work was begun, and the disease now rarely causes losses in herds which have received the preventive-serum treatment properly administered.

During the fiscal year which ended June 30, 1918, hog-cholera work was extended to 34 States, principally those in which swine raising is a well-developed branch of the livestock industry. A force averaging 165 veterinarians has been maintained, working in cooperation with State authorities in charge of quarantine and other regulatory measures necessary for the success of control work. The activities of the Federal veterinarians have been of widely varied character, but the main goal toward which the work converges is the suppression of hog cholera and the improvement of hog health.

FIELD WIDE IN SCOPE.

To this end the Bureau of Animal Industry veterinarians make investigations of reported outbreaks of hog cholera, hold autopsies, diagnose animal diseases, and give instruction in the treatment and handling of outbreaks, including the proper disposal of dead animals. They supervise treatment of hogs and the disinfection of premises when necessary. In addition to this main phase of the work, they advise with practicing veterinarians concerning the importance of proper diagnosis and the use of the preventive-serum treatment for hog cholera. Special stress is placed on right methods of disinfection and the manner of dealing with infectious and contagious diseases. They also disseminate knowledge in the proper use of modern biological products.

During the war emergency, the efforts of department veterinarians were helpful in conserving and increasing production of pork products and fats. The extent to which hog raisers are now protecting their swine against cholera is shown by the increasing practice of vaccination and the adoption of sanitary measures. During the fiscal year 1918 more than five and one-half million hogs were inoculated with antihog-cholera serum, and somewhat more than 2,200 farms, found to be infected with cholera, were cleaned and disinfected under supervision of the department veterinarians. Altogether, representatives of the department visited more than 15,000 farms to investigate reported outbreaks, to apply preventive measures, and to clean and disinfect premises.

In addition to the control work, educational activities, such as meetings at which demonstrations and lectures dealing with recognized methods of preventing the disease were given, have been attended by more than 100,000 farmers. This class of work is commonly conducted in cooperation with extension branches of the agricultural colleges, with the object of creating interest in control measures.

SAFETY FROM CHOLERA ENCOURAGES PRODUCTION.

An important result of hog-cholera control work has been the stimulus given the development of swine raising in the South. In connection with other activities of the department in this line, the assurance given to southern farmers that hogs can be produced without fear of losses from cholera has encouraged growing not only larger numbers of animals but also better types. This feature has been noticeable particularly in Georgia. A few years ago that State purchased about 40,000,000 pounds of pork more than it produced annually, but efforts for the control of hog cholera have gradually extended over the entire State, with resulting confidence in hog raising. By 1918 Georgia was producing pork enough to make shipments to outside points, besides supplying a large number of hogs to its local slaughtering establishments. Similar progress has been made in Mississippi, Alabama, and Florida.

Now that definite proof has been furnished that hog cholera is preventable, the Southern States, aided by many



FIG. 1.—AN IMPORTANT PRECAUTION IN HOG-CHOLERA CONTROL.
To prevent the spread of hog cholera in a locality every person who leaves an infected farm should thoroughly disinfect his shoes.

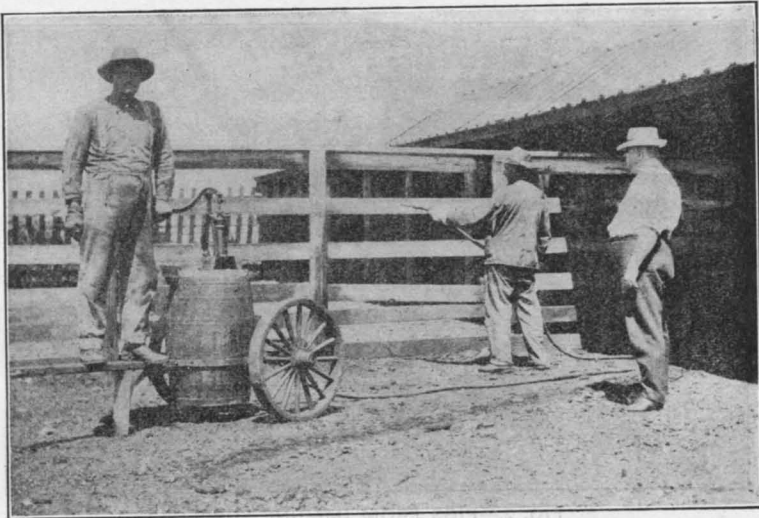

FIG. 2.—A PRACTICAL AND INEXPENSIVE DISINFECTING OUTFIT.
After an outbreak of hog cholera has been suppressed, disinfection of the premises is necessary. The work here is being supervised by a Government inspector.



FIG. 1.—A HERD OF IMMUNE BROOD SOWS.

Every sow in this picture received the preventive-serum treatment, which makes her immune from hog cholera and protects the owner against loss.



FIG. 2.—PIGS FROM IMMUNE SOWS.

Inoculation of breeding stock to protect them from hog cholera is absolutely harmless. These 63 pigs are from 7 immune sows.

favorable factors, such as reasonably low land values, cheap feed, and mild climate, no doubt will excel in swine production.

The application of sanitary measures and the proper use of the preventive-serum treatment have accomplished results gratifying in individual cases but most striking when considered collectively. How great a menace hog cholera has been to the Nation's swine industry may be judged from the accepted estimate that 90 per cent of hogs lost through all ailments die from cholera. In 1918, however, the death rate of swine from disease was placed at 42.1 per 1,000 head, making the mortality rate from cholera practically 38 per thousand. Thus the loss was somewhat less than 4 per cent for the United States, the lowest on record, according to the department's figures.

HOPE REPLACES DISCOURAGEMENT.

Results so encouraging may be credited principally to a more general application of sanitary measures and the proper use of the preventive-serum treatment. In some sections the reported ravages of cholera had discouraged hog raisers because losses from the disease were more than the profits from the surviving animals.

Immunizing swine against the disease, however, combined with proper handling—both of which are included in the department's field activities—has convinced farmers that the industry is a profitable investment and can be engaged in with entire safety. According to best estimates the number of swine produced last year exceeded any previous record in the history of the industry. The increase, though largely a patriotic undertaking, was also accelerated by confidence among producers in the effectiveness of cholera-control methods.

The continued world need for pork and its products calls for renewed efforts in cholera control with the view ultimately of eradicating the disease from this country's herds. To that end the department asks for a full measure of continued cooperation from every one interested in the increased production and improvement of swine.

Though a disease for which there is still no reliable cure, hog cholera can be prevented, safely and with certainty, by

immunizing the animals according to the methods developed and now in general use. To be sure, much progress has been made, but in the aggregate the losses are still enormous and the risk in unvaccinated herds is greater than ever, owing to the high plane of prices for both breeding animals and those raised for meat. On every farm where hogs are raised the opportunity now exists to take advantage of the means available—vaccination and better sanitation—further to decrease swine losses. Those caused by cholera are now less than 4 per cent, but we must not stop until the disease becomes extinct in the United States.

SOME EFFECTS OF THE WAR UPON THE SEED INDUSTRY OF THE UNITED STATES.

By W. A. WHEELER, *Specialist in Seed Marketing*, and G. C. EDLER, *Investigator in Seed Marketing, Bureau of Markets*.

MORE SEEDS WILL BE HOME GROWN.

ONE of the basic agricultural industries that have undergone many changes, influenced by the war, is the seed industry in the United States. Doubtless some of these changed conditions will become permanent features of the industry, with the result that this country will tend to become more independent of the world's supply of seeds. It is perhaps true that in the production of certain kinds of vegetable seeds the United States has not reached the same degree of perfection that some other countries have reached after many years and generations of specialized effort; yet, at the same time, few, if any, countries have ever made the rapid strides in vegetable-seed production that this country did during the war.

Many of the effects that have been noted may or may not be permanent. It is too soon after the close of the war to prognosticate their permanency, but their future is worthy of careful study at this time. Often it is difficult to differentiate between those effects that are traceable directly to the war and those that are an indirect result of the war, but some of those that have been noted are discussed rather briefly in this article.

EFFECT OF THE WAR UPON IMPORTS AND EXPORTS.

In Table 1 are given figures compiled from data obtained from the Bureau of Foreign and Domestic Commerce, of the Department of Commerce, showing the imports of the United States during the first year after our entry into the war, and our average annual imports during the three-year war period ending June 30, 1917, as compared with the average annual imports before the war for a five-year period ending June 30, 1914. A study of these figures will reveal the fact that of practically all field and vegetable seeds used

exclusively for planting purposes the imports before the war exceeded those during the war, and in most cases the difference is considerable. The table was published in the issue of the Seed Reporter for October 5, 1918.

TABLE 1.—*Imports of field, vegetable, and flower seeds into the United States.*

Kind of seed.	Imports, first year of United States war, year ending, June 30, 1918.	Average annual im- ports, 3-year war period ending June 30, 1917.	Average annual im- ports, pre- war period ending June 30, 1914. ²
	<i>Pounds.</i>	<i>Pounds.</i>	<i>Pounds.</i>
Beet, sugar.....	15,636,541	13,135,456	11,616,300
Beet, "all other".....	447,878	753,376	819,715
Cabbage.....	83,210	270,470	252,528
Carrot.....	32,500	46,651	149,724
Castor bean ¹	58,048,090	46,060,550	43,818,060
Cauliflower.....	7,969	9,963	8,711
Celery ¹	167,684	667,695	199,358
Collard.....	17	3,073	667
Corn salad.....	1,945	4,843	7,068
Eggplant.....	2,069	1,057	1,795
Kale.....	8,016	34,965	30,326
Kohl-rabi.....	16,770	12,025	21,409
Mushroom spawn.....	16,923	79,234	279,064
Mustard ¹	13,035,837	12,174,056	10,819,715
Parsley ¹	66,494	82,283	118,112
Parsnip.....	7,065	88,477	89,702
Pepper.....	21,884	11,729	14,515
Radish.....	102,735	326,344	491,097
Spinach.....	804,789	869,321	1,241,758
Turnip and rutabaga.....	2,150,965	1,664,728	1,735,033
Flower seeds ³	\$126,422	\$198,512	\$239,371
Alfalfa.....	87,244	3,996,613	7,301,712
Alsike clover.....	3,665,037	2,042,314	6,057,196
Crimson clover.....	1,601,503*	6,765,753	8,537,597
Red clover.....	861,709	15,968,322	12,328,449
White clover.....		230,073	1,263,881
Clovers, "all other".....	2,062,429	2,654,762	4,801,686
Grasses, "all other".....	5,618,204	11,888,185	16,644,424
Hairy (winter) vetch.....	178,766	265,001	2,948,075
Common (spring) vetch.....		65,179	753,705
Rape ¹	12,673,276	6,663,615	5,668,952
Soy beans ¹	31,812,997	4,061,755	1,929,435

¹ Imported both for planting and other purposes.

² The prewar period from which this average has been computed includes 5 years from June 30, 1909, to June 30, 1914, for the first 21 items covering vegetable and flower seeds, and 3 years from June 30, 1911, to June 30, 1914, for the remaining items covering field seeds, except soy beans, for which the imports only for the year ending June 30, 1914, of that period are available.

³ Figures given indicate value in dollars instead of quantity in pounds.

During the war the exports of vegetable seeds and of some field seeds, which in the past have been imported in larger quantities than they have been exported, in the main greatly exceeded the exports before the war, despite the fact that many restrictions had to be placed on seed exports to conserve ocean tonnage, to insure a sufficient supply of seed at home, and to guard against shipments billed to neutral countries but ultimately meant for enemy countries. Unfortunately, export figures for field and vegetable seeds are not available except somewhat incomplete figures for the fiscal years ending July 1, 1917 and 1918. The exports of vegetable seeds for these two fiscal years compared with the anticipated exports for the fiscal year ending July 1, 1919, as reported to the United States Bureau of Markets, by the largest seed dealers indicate that a marked increase in the exports of vegetable seeds has taken place during the war, even at a time when our own domestic demand was greater than ever before. Table 2 shows where the greatest gains in vegetable seed exports were made.

DOMESTIC DEMANDS FOR SEED.

The war has had a far-reaching effect upon the domestic demand for vegetable seed and certain kinds of field seed. By means of the publicity given by the various agencies of the Government and by seedsmen and periodicals to war gardens, a greater demand for vegetable seed arose than was ever before experienced. People in cities who had never planted gardens were influenced to "do their bit" toward solving the food problem by making gardens. While it is true that in some localities the sales of seed to market gardeners decreased, this was more than offset by the small sales to the vastly increased number of amateur gardeners.

In order to help feed the allies, the farmers of this country, spurred on by record prices, patriotically responded to the appeal for more food crops by planting greater acreages of wheat, corn, oats, rye, barley, etc., and, while conditions were not always favorable, they succeeded in surpassing the record production of many of these crops. Increased acreage, of course, meant an increased demand for seeds with which to plant these crops, and a higher percentage of the

quantity of seed planted of wheat, corn, oats, and barley was sold commercially in 1918 than in 1917, and probably than in most of the years prior to the war. While it is true that a comparatively small percentage of the seed of grain crops is sold for planting purposes by commercial agencies, nevertheless this small percentage often is of the greatest importance, and the seed dealers were quick to sense the increased demand for seed grains.

TABLE 2.—*Vegetable seed exports for the United States.*

Item.	Estimated quantity reserved for export during year ending July 1, 1919. ¹	Exports for year ending July 1, 1918. ²	Exports for year ending July 1, 1917. ²
	<i>Pounds.</i>	<i>Pounds.</i>	<i>Pounds.</i>
Beans, dwarf snap.....	337,049	199,002	194,959
Beans, garden pole (not including lima).....	58,459	26,552	17,234
Beet, garden.....	160,404	42,293	44,283
Beet, mangel.....	31,696	7,355	16,619
Beet, sugar.....	60,260	30,346	300
Cabbage.....	2,468	15,468	17,237
Carrot.....	959,314	400,009	159,270
Cauliflower.....		516	355
Celery.....	11,728	3,997	1,927
Cucumber.....	30,943	38,653	44,921
Kale.....		214	277
Lettuce.....	306,353	270,426	313,678
Muskmelon.....		2,600	3,023
Watermelon.....		6,205	7,499
Onion seed.....	408,410	242,232	291,783
Onion sets.....		233,400	358,424
Parsley.....		9,406	5,258
Parsnip.....	54,393	16,733	10,422
Peas, garden.....	4,384,177	2,713,101	7,289,225
Pepper.....	516	931	851
Pumpkin.....		2,894	2,487
Radish.....	346,527	104,048	59,065
Salsify.....		18,124	2,805
Spinach.....	46,990	9,216	1,992
Squash, summer.....		2,789	2,872
Squash, winter.....		2,950	2,545
Sweet corn.....	380,816	409,225	215,187
Tomato.....	10,443	10,913	5,387
Turnip, English.....	9,397	92,304	6,841
Turnip, Swede.....	28,938	25,990	10,514

¹ Seed Export Survey of Sept. 11, 1918.² Seed Survey of July 1, 1918.

The increased acreage of food crops was generally at the expense of grass or forage crops, a condition similar to that which existed in European countries. The demand for these seeds, therefore, appears with certain exceptions to have been less than usual. The demand for clover seed, sown in many localities more for improving the soil than for the revenue it brings as a hay or seed crop, has been exceedingly good during the war.

INFLUENCE OF WAR ON SEED PRODUCTION.

The production of vegetable seed in the United States has been revolutionized by the war. Previously, most of the beet, carrot, radish, and spinach seed planted in this country was imported from Great Britain and France, and to a less extent from other countries. Instead of an importer of these and other seeds, the United States became an exporter, and the gains made in exports have already been shown in Table 2. In 1916, European countries began placing large contracts with commercial seed growers in the United States for the production of many crops which in the past had not been grown here on a commercial scale.

In order to take care of the increasing domestic and foreign demand and the falling off of imports, the acreage planted in old, proved localities was increased and new areas of production were sought, particularly with reference to vegetable seeds, but to a much less degree with reference to field seeds. While some new areas were found to give better yields or seeds of better quality than did old areas, the expense of pioneering was often such a drawback as to discourage further increased production in many of the new areas. However, it is apparent to many growers that certain kinds of seed may be produced in a number of places in this country, and that one of the best assurances against total failure of seed crops is the diversification of acreages as much as possible. At the same time it is realized that certain localities are better adapted for the production of a few kinds of seed than are other localities.

Figures 4 to 9 show the location of the counties in the United States in which many of the most important vegetable seeds are grown. Table 3 shows the commercial

**TOMATO, PEPPER, CARROT, CELERY, AND SALSIFY
COUNTIES IN WHICH GROWN COMMERCIALY FOR SEED IN 1918**

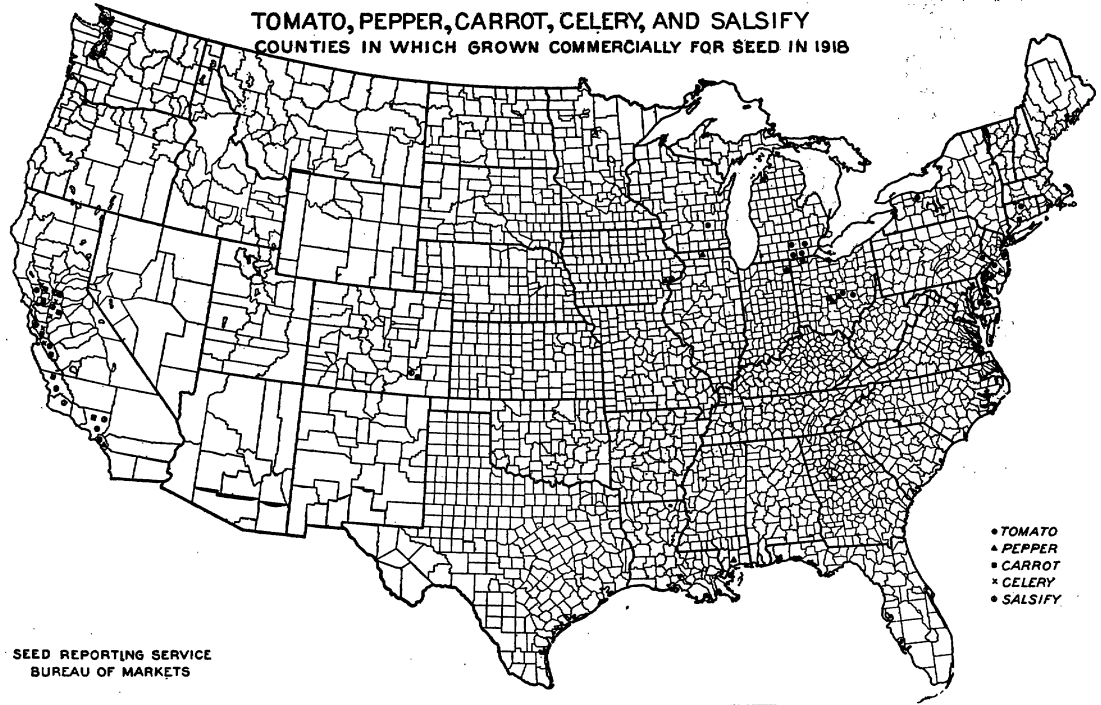

SEED REPORTING SERVICE
BUREAU OF MARKETS

CUCUMBER, MELONS, SQUASH, AND PUMPKIN
COUNTIES IN WHICH GROWN COMMERCIALY FOR SEED IN 1918

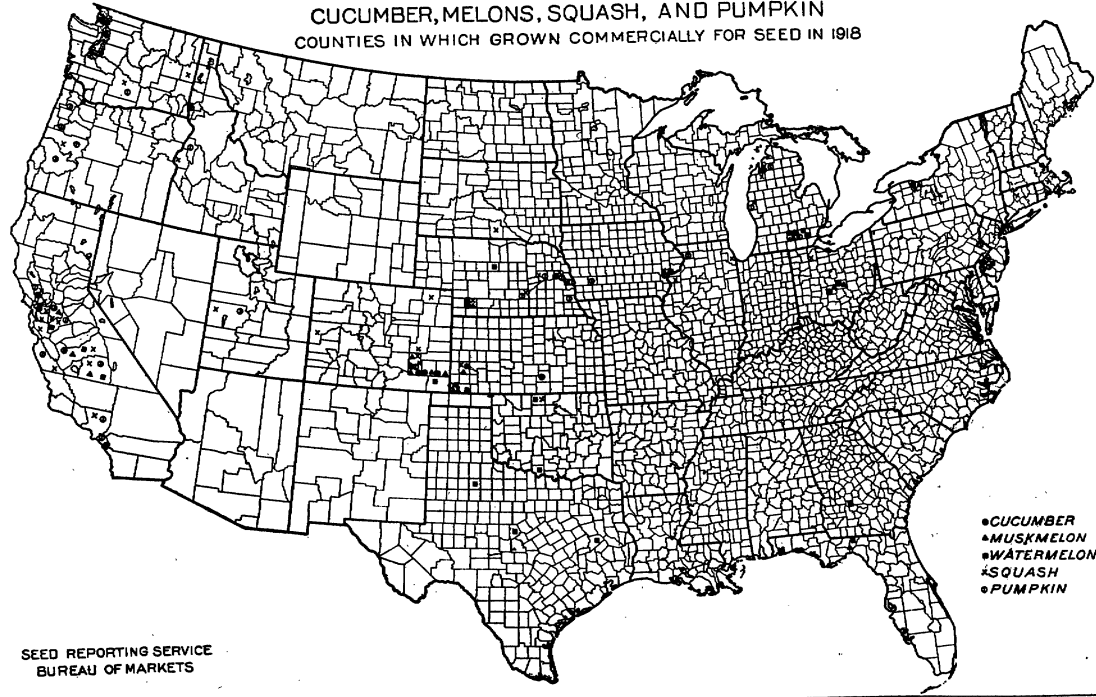

- CUCUMBER
- ▲ MUSKMELON
- WATERMELON
- ✕ SQUASH
- ◉ PUMPKIN

SEED REPORTING SERVICE
BUREAU OF MARKETS

FIG. 5.

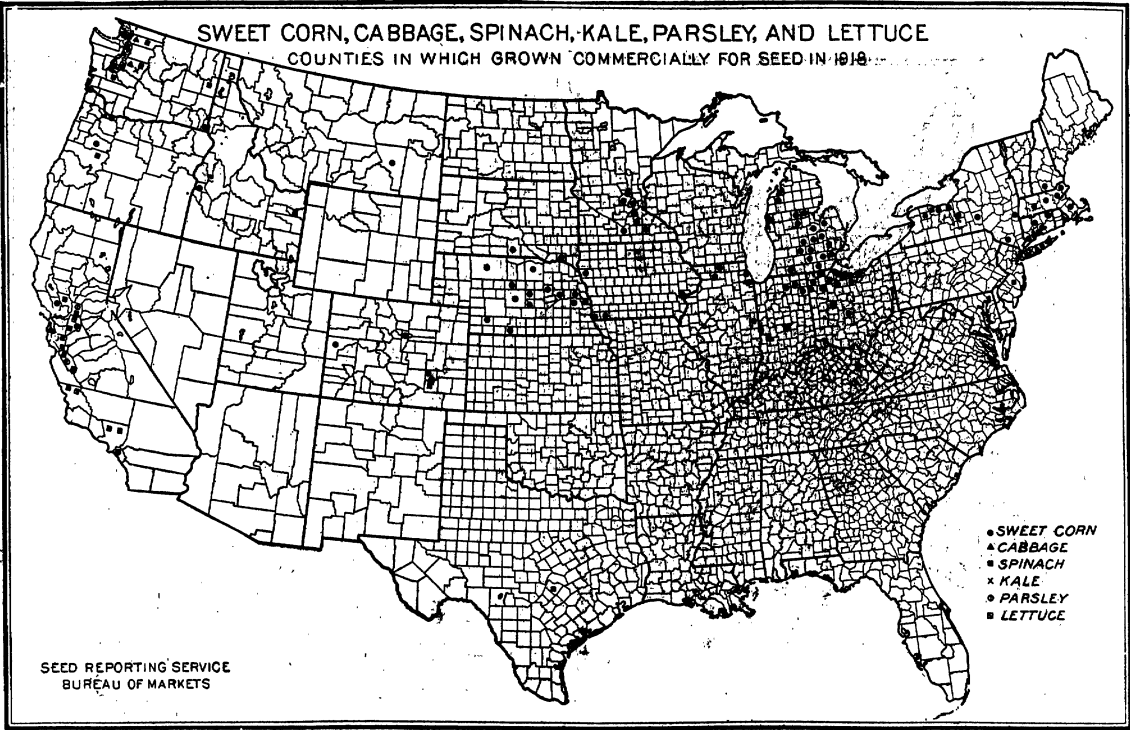

FIG. 6.

ONION SEED AND SETS, RADISH, TURNIP, AND PARSNIP
COUNTIES IN WHICH GROWN COMMERCIALY FOR SEED IN 1918

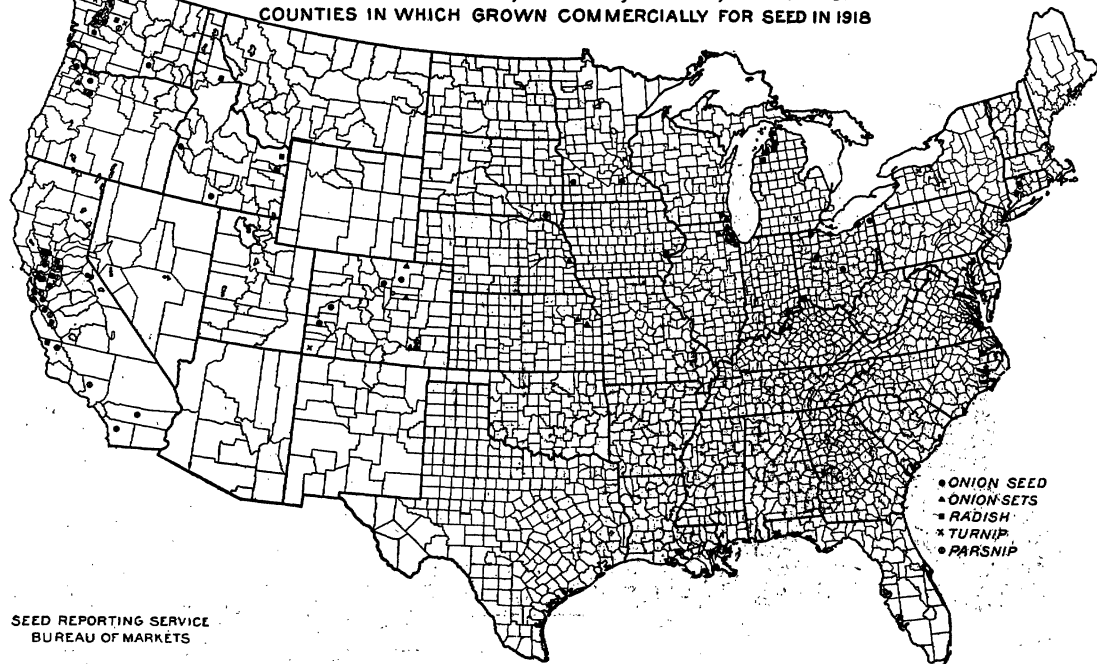

FIG. 7.

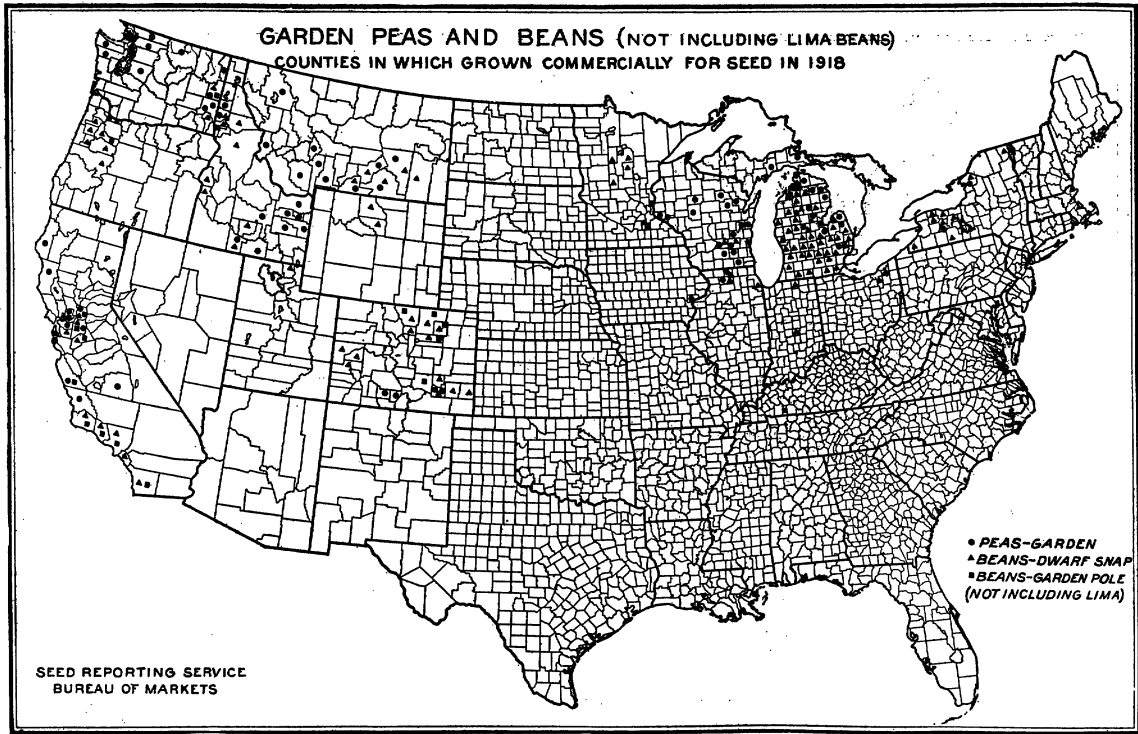

FIG. 8.

SUGAR BEET, GARDEN BEET, AND MANGEL
COUNTIES IN WHICH GROWN COMMERCIALY FOR SEED IN 1918

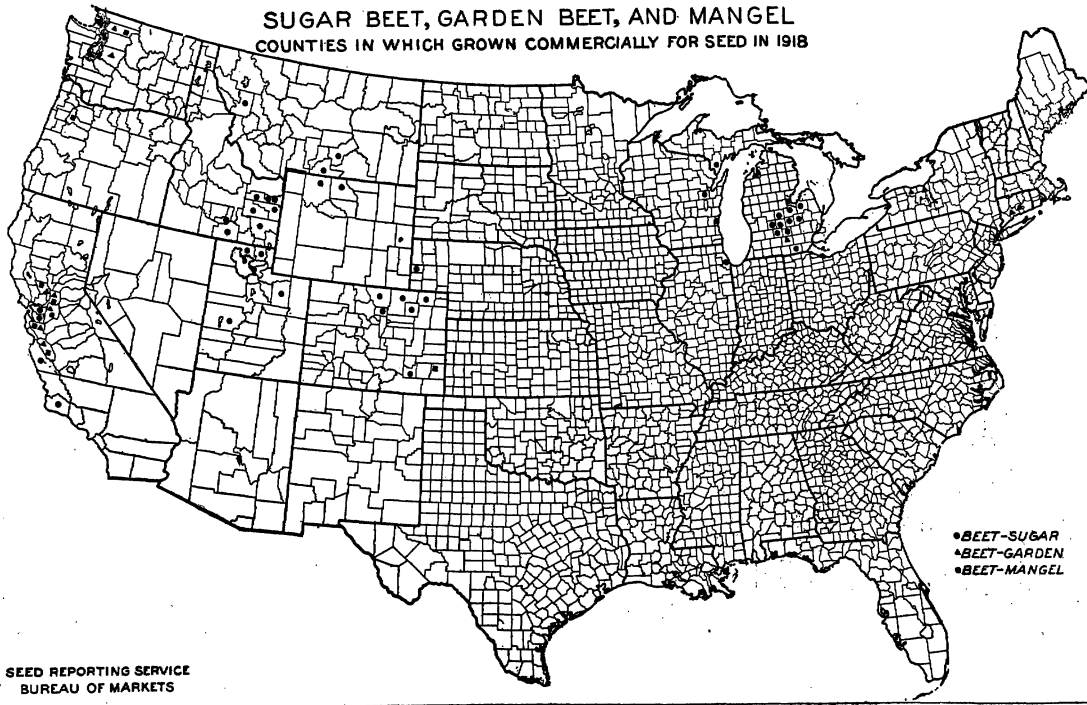

FIG. 9.

acreage, average yield per acre, commercial production, and consumption of vegetable seed crops in 1918, 1917, and 1916, as reported to the Bureau of Markets in a survey made July 1, 1918.

TABLE 3.—*Commercial acreage, average yield per acre, commercial production, and estimated commercial consumption of vegetable seed for the United States.*

[A revised tabulation of reports from 185 commercial vegetable-seed growers reporting in the vegetable-seed production survey of July 1, 1918, including information and estimates from other sources.]

Kind of seed.	Commercial acreage.			Average yield per acre.		
	1918	1917	1916	1918 estimated.	1917	1916
	<i>Acres.</i>	<i>Acres.</i>	<i>Acres.</i>	<i>Pounds.</i>	<i>Pounds.</i>	<i>Pounds.</i>
Beans, dwarf snap.....	70,868	63,524	63,581	514	234	237
Beans, garden pole (not including lima).....	6,297	4,029	4,971	627	315	243
Beet, garden.....	2,748	826	342	889	562	587
Beet, mangel.....	418	20	5	873	1,504	720
Beet, sugar.....	6,014	4,638	5,655	980	1,094	980
Cabbage.....	974	737	765	161	393	284
Carrot.....	4,622	1,965	1,039	508	574	574
Celery.....	175	84	85	370	335	611
Cucumber.....	3,053	4,694	4,397	210	218	209
Kale.....	71	18	55	153	250	540
Lettuce.....	2,276	1,979	1,723	320	457	626
Muskmelon.....	1,558	1,827	1,791	148	161	155
Watermelon.....	10,522	8,929	6,249	105	71	75
Onion seed.....	7,233	3,782	3,181	205	259	418
Onion sets.....	3,470	2,637	2,478	11,380	11,851	9,184
Parsley.....	155	109	78	360	772	1,583
Parsnip.....	269	137	90	743	499	748
Peas, garden.....	110,194	110,129	72,130	598	444	721
Pepper.....	715	686	432	100	31	39
Pumpkin.....	1,490	1,512	1,201	151	72	94
Radish.....	8,646	3,521	2,631	225	176	274
Salsify.....	123	131	52	228	431	624
Spinach.....	3,942	1,415	123	395	220	364
Squash, summer.....	916	836	1,068	158	145	154
Squash, winter.....	2,539	1,328	1,131	102	70	78
Sweet corn.....	13,934	12,975	14,420	1,180	640	588
Tomato.....	4,024	3,204	2,460	71	92	76
Turnip, English.....	766	24	54	290	127	375
Turnip, Swede.....	271	21	10	80	418	384

TABLE 3.—Commercial acreage, average yield per acre, commercial production, and estimated commercial consumption of vegetable seed for the United States—Continued.

Kind of seed.	Commercial production.			Estimated commercial consumption, year ending July 1.	
	1918 estimate.	1917	1916	1918	1917
	Pounds.	Pounds.	Pounds.	Pounds.	Pounds.
Beans, dwarf snap.....	36,425,000	14,809,000	15,074,000	13,700,000	15,550,000
Beans, garden pole (not including lima).....	3,950,000	1,288,000	1,208,000	1,790,000	1,630,000
Beet, garden.....	2,440,000	464,000	200,000	480,000	480,000
Beet, mangel.....	365,000	30,000	3,600	320,000	320,000
Beet, sugar.....	5,900,000	5,076,000	5,539,000	13,800,000	11,200,000
Cabbage.....	157,000	292,000	217,000	485,000	500,000
Carrot.....	2,350,000	1,129,000	534,000	455,000	405,000
Celery.....	65,000	28,100	5,200
Cucumber.....	640,000	1,026,000	920,000	830,000	525,000
Kale.....	10,900	4,500	29,000	48,000	64,000
Lettuce.....	730,000	903,000	1,078,000	470,000	585,000
Muskmelon.....	230,000	293,000	277,000	300,000	220,000
Watermelon.....	1,100,000	633,000	470,000	505,000	485,000
Onion seed.....	1,480,000	980,000	1,329,000	1,030,000	1,165,000
Onion sets.....	39,500,000	31,249,000	22,756,000	30,950,000	22,300,000
Parsley.....	56,000	84,000	123,000	144,000	125,000
Parsnip.....	200,000	68,000	67,000	120,000	155,000
Peas, garden.....	65,912,000	48,868,000	52,014,000	50,300,000	53,400,000
Pepper.....	71,500	21,000	47,000	33,000	31,000
Pumpkin.....	225,000	108,000	111,000	87,000
Radish.....	1,940,000	621,000	720,000	855,000	935,000
Salsify.....	28,000	56,000	32,000	25,000	21,000
Spinach.....	1,560,000	300,000	45,000	785,000	930,000
Squash, summer.....	145,000	121,000	164,000	101,000	105,000
Squash, winter.....	260,000	93,000	87,000	102,000	114,000
Sweet corn.....	16,500,000	8,303,000	8,468,000	8,900,000	7,460,000
Tomato.....	287,000	227,000	187,000	206,000	234,000
Turnip, English.....	222,700	3,000	20,000	1,550,000
Turnip, Swede.....	22,000	8,700	3,800	400,000

It will be noted that a marked increase in acreage is reported for 1918 for garden beet, mangel beet, carrot, onion, radish, spinach, winter squash, English turnip, and Swede turnip seed. Unfortunately, no figures approaching in completeness those given in Table 3 are available for the prewar period, but there is no question that the acreage of the above-mentioned crops, as well as many others, in any one year of the prewar period, was in almost every case

considerably less than even the 1916 acreage of each of these seed crops.

While the war stimulated the production of most kinds of vegetable and field seed, it had a deterrent effect upon the production of other kinds commonly exported from this country, such as timothy, reedtop, meadow fescue, and Kentucky bluegrass. High hay prices, increased acreages of food crops, and limited demand for seeds of grass crops from European countries, among other factors, resulted in the cutting of a smaller acreage of the grasses for seed purposes during the war. Since the close of the war, however, an increasing demand for grass seeds is apparent because of the approach of more normal conditions in European countries which permit of more diversified farming.

SEED STOCKS.

Larger stocks of most of the field and vegetable seeds were held by seedsmen during the war than were held before the war. There were many reasons for this. The demand for them was greater and on account of the uncertainties attendant upon domestic production of kinds that formerly were imported, larger growing contracts were placed with the commercial seed growers, with the result that when larger deliveries were made than were anticipated larger stocks had to be carried. Furthermore, the ever-increasing high prices for seed, which will be discussed later, also had a tendency to cause the larger seedsmen to buy more than they had been accustomed to do in the past. A larger percentage of the stocks of vegetable seed was grown in the United States during the war than before the war, which meant inferior quality with some kinds and possibly superior quality with other kinds. In the opinion of some seedsmen, quantity rather than quality seed production was so uppermost in the minds of growers that quality was thereby sacrificed. On the other hand, the small country merchant handling field or vegetable seeds in bulk often was loath to buy heavily much in advance of the planting season because of the high prices prevailing on most kinds; hence increased stocks had to be carried by the larger seedsmen during the war.

There was a pronounced tendency on the part of many seedsmen to reduce the number of varieties of vegetable

seeds handled by them, to minimize the number of so-called novelties, and to emphasize the standard varieties. This was in keeping with the spirit of conservation that was so much in evidence during the war.

EFFECT OF THE WAR ON PRICES.

Prices on practically all field and vegetable seed advanced with the increased cost of production and marketing and in sympathy with other agricultural and manufactured commodities. Commercial vegetable-seed growers had to pay the small growers with whom they contracted considerably higher prices, and additional help at roguing and harvest time commanded much higher wages than have ruled in the past. Because food crops were commanding such high prices, small vegetable seed growers preferred to grow them rather than vegetable seeds, and many growers were induced to continue producing vegetable seed only after much higher prices were offered them for doing it.

Thus it was necessary for the commercial growers to ask higher prices on their growing contracts with seedsmen. In turn, seedsmen found that the cost of doing business was greater and the risks assumed more hazardous. All these factors were reflected in the higher prices at which seedsmen catalogued their vegetable seeds for 1918. In Table 4, compiled from a large number of retail mail-order catalogues of representative seedsmen, the prices given represent retail prices of standard varieties of seed for 1918, and for the same varieties in 1917. The increase in prices of 1918 over those of 1917 range from about 5 per cent on celery up to 260 per cent on Swede turnip seed, and average for the items listed about 60 per cent.

Prices on most of the field seeds were considerably higher during the war than prior to it, but it is very difficult to determine how much of the increase was due to the war and how much to unfavorable climatic conditions. High prices for food and hay crops were largely responsible for the reduction in the acreage of grasses and clovers cut for seed purposes, and, with yields per acre equal to or less than the average, the production of these seeds was decreased, a factor which affected prices.

TABLE 4.—*Retail prices of standard varieties of seed, 1917 and 1918.*

Crop.	1918		1917	
	Per ounce.	Per pound.	Per ounce.	Per pound.
	<i>Cents.</i>	<i>Cents.</i>	<i>Cents.</i>	<i>Cents.</i>
Beet, garden.....	20	234	13	132
Beet, mangel.....	13	132	8	57
Cabbage.....	45	505	25	298
Carrot.....	22	223	14	142
Celery.....	54	635	52	597
Cucumber.....	14	177	11	93
Lettuce.....	15	141	14	134
Muskmelon.....	17	152	16	117
Watermelon.....	12	97	11	79
Onion seed.....	55	516	23	250
Parsley.....	13	107	11	88
Parsnips.....	18	176	10	68
Radish.....	21	167	10	67
Spinach.....	19	212	11	89
Squash, summer.....	14	138	10	94
Squash, winter.....	15	148	12	96
Tomato.....	38	411	29	297
Turnip, English.....	18	196	10	69
Turnip, Swede.....	22	235	9	65
	Per quart.		Per quart.	
	<i>Cents.</i>		<i>Cents.</i>	
Beans, dwarf snap.....	79	43	62	32
Beans, garden pole.....	76	41	45	26
Peas, garden.....	61	37	43	23
Sweet corn.....	61	38	47	26

In the case of seed corn in the spring of 1918, most of the price increase should be charged up to a backward growing season in 1917 and early, heavy frost that year. Climatic conditions in 1917 and 1918 also were responsible in considerable measure, together with the small carry-over on July 1, 1917, and still smaller carry-over on July 1, 1918, for the high prices for red-clover seed. The prices of such seeds as timothy, redbtop, meadow fescue, and Kentucky bluegrass, a large percentage of the crop of which is normally exported each year, remained nearer prewar levels than did the clovers, seed grains, etc., largely because there appeared to be very little demand in European countries for seeds of the

grasses. In the winter of 1917-18, red-clover seed reached the highest prices on record, but these prices have been exceeded by those prevailing during the fall of 1918 and winter of 1918-19. A comparison of red-clover seed prices on December 1 for "contract, prime grade" on the Toledo market extending over a period of 12 years may be made from the figures given below :

	Price per bu.		Price per bu.
1918.....	\$25. 30	1912.....	\$11. 15
1917.....	15. 90	1911.....	12. 62
1916.....	10. 70	1910.....	9. 00
1915.....	12. 05	1909.....	8. 77
1914.....	9. 22	1908.....	5. 57
1913.....	8. 75	1907.....	9. 95

MOVEMENT OF SEEDS.

The transportation situation became so bad during 1917 and 1918 that its effect was very apparent to those wishing to ship seed either by carload or less than carload lots. In some cities, seedsmen pooled with one another their shipments destined for points in the same direction, and closer cooperation in this respect, as well as in others, was more evident than ever before. Embargoes on freight shipments became the rule rather than the exception. The fact that seeds were placed on the preference list did not alleviate conditions much for the seedsmen. Express shipments were made when freight shipments were impossible, but it was not long before express shipments became demoralized. Many seedsmen reported the arrival of seeds from the West too late for planting that season, which was partly responsible for a larger carry-over of some kinds of vegetable seed than usual on the part of many dealers.

LOCAL PROBLEMS OF WHOLESALE AND RETAIL SEEDSMEN.

In the foregoing, some of the effects upon the seed industry have been pointed out without any specific reference to the changes with which many seedsmen themselves found it necessary to cope. Seedsmen who in the past had relied on the profits derived from exporting or importing seed for the maintenance of their business, soon found that they

could import little or no seed of the kinds handled by them, and were restricted so much in the matter of exports that they had to look for an outlet for their seed in the United States. New areas in this country in which to purchase and also to sell seeds had to be found by many of the seedsmen in order that they might continue in business. Thus they competed with other seedsmen who had been accustomed to buy or sell in these areas.

On account of the uncertainties of distant freight shipments, country merchants were more inclined than usual to place their late spring orders with local or near-by seedsmen. This, of course, affected the business of some of the larger and more distant seedsmen, who formerly sold to these same country merchants.

In order to get business, a few large seed concerns, which formerly were in the habit of attaching sight draft to bill of lading, sold seed on "trade acceptance" terms. Seed shipped by them was paid for by the purchaser with some bankable paper payable in four months or less with interest at about 6 per cent. Though similar arrangements have been made in the past by a few seedsmen, they were little known in the seed trade before the war.

Many dealers reported that it was more difficult to negotiate large loans with the banks because of frequent, temporary depressions. With seed generally higher and money scarcer, field seedsmen often were reluctant to carry as large stocks as customarily. The chances of big profits or losses in the field seed business were greater than in peace times because of the larger and more frequent fluctuations in the prices of seeds.

THE SEED REPORTING SERVICE OF THE BUREAU OF MARKETS.

In order to act somewhat as a balance wheel to the seed trade and as a guide to the various agencies of the Government in handling the seed end of the food-production problem, the Bureau of Markets shortly after war was declared established a Seed Reporting Service. In the matter of seeds, the first great concern of the Nation was to insure, so far as possible, an ample supply of seed of crops that would help feed this country as well as the allies, and to see

that this supply was made available and distributed as economically and efficiently as possible. It is an economic waste of time and resources to produce seed of a kind that is not needed or wanted much in excess of the demand for it.

By means of the figures published in the Seed Reporter, the official organ of the Seed Reporting Service, showing carry-over and current stocks on hand, exports and imports, as well as other information, growers and dealers could determine to some extent whether or not the growing or handling of various kinds of seeds would result in profit to them.

In the case of vegetable seed, the data given served well as an indicator of which kinds would probably be short for the next planting season unless the acreage devoted to their production was increased considerably or the yield per acre proved to be much above the average. While it is true that some of the larger growers would have gone ahead increasing their own acreage of certain crops two or more fold, many of the growers would have hesitated to place contracts with growers at greatly increased prices, knowing as they did that the labor shortage during the growing season and at harvest time might be even more acute than at planting time, if they had not had access to information which indicated clearly that there would be a good demand for practically all of the seed they could produce of most kinds of vegetable crops.

Published contract prices paid to small growers, and wholesale and retail prices of seedsmen enabled commercial growers to determine whether or not they were paying their growers too much or too little as compared with other commercial growers, whether or not seedsmen were purchasing or selling at prices out of line with analogous prices of other seedsmen, and whether or not the consumers had a right to object to prices paid by them.

Preliminary estimates of the production of field or vegetable seed, either actual or as compared with normal or with the preceding year, together with figures showing the carry-over and other information, helped to establish more quickly prices of various field seeds; to place buyer and seller on more equal terms so far as knowledge of the supply and demand for particular seeds was concerned; and to assist governmental agencies in formulating a policy with reference

to the advisability of allowing the exportation of certain kinds of vegetable or field seeds with or without restriction. The Seed Reporting Service of the Bureau of Markets has been able to supply the information needed to pass upon the necessity of importing certain kinds of seed or of exporting others, or upon the importance of the conservation of certain kinds of seeds and of the urgency for the stimulation of their production. Without such a well-organized agency, the Government would not have been able to pass intelligent judgment upon or to make proper recommendations concerning these questions.

THE ACCREDITED-HERD PLAN IN TUBERCULOSIS ERADICATION.

By J. A. KIERNAN,

Chief, Tuberculosis Eradication Division, Bureau of Animal Industry.

PART OF A GENERAL PLAN FOR ERADICATING TUBERCULOSIS.

THE TUBERCULOSIS-FREE accredited-herd plan is one project of the general plan of a campaign which has been inaugurated for the eradication of tuberculosis from live stock in the United States. This plan was adopted jointly in December, 1917, by the live-stock sanitary officials of all the States in the Union and the Bureau of Animal Industry, United States Department of Agriculture.

Progress in eradicating any widespread animal disease depends not only on suitable methods of control, but also in large measure on the desire of live-stock owners to cooperate. It is important that they understand clearly why the work is done, the methods of conducting it, and the benefits which the completed work will bring:

Eradication of tuberculosis from live stock means primarily the removal of a constant source of danger to the health of mankind as well as of animals; also it will reduce sharply the economic losses from animal disease.

To accredit a herd as free from tuberculosis means briefly to certify officially that the owner has complied with specified requirements. Best results may be expected only when every live-stock owner becomes familiar with the provisions of the accredited-herd plan, which are as follows:

METHODS AND RULES FOR ACCREDITING HERDS OF CATTLE.

The rules below were unanimously adopted by the United States Live Stock Sanitary Association and by representatives of pure-bred cattle-breeders' associations, and approved December 23, 1917, by the Bureau of Animal Industry, United States Department of Agriculture.

1. A tuberculosis-free accredited herd is one which has been tuberculin-tested by the subcutaneous method, or any other test approved by the Bureau of Animal Industry, under the supervision of the Bureau of Animal Industry or a regularly employed veterinary inspector of the State in which cooperative tuberculosis-eradication work is conducted jointly by the United States Department of Agriculture and the State. Further, it shall be a herd in which no animal affected with tuberculosis has been found upon two annual or three semi-annual tuberculin tests, as above described, and by physical examination.

2. The entire herd, or any cattle in the herd, shall be tuberculin-tested or retested at such time as is considered necessary by the Federal and State authorities.

3. No cattle shall be presented for the tuberculin test which have been injected with tuberculin within 60 days immediately preceding or which have at any time reacted to a tuberculin test.

4. No herd shall be classed as an accredited herd in which tuberculosis has been found by the application of the test, as referred to in paragraph 1, until such herd has been successfully subjected to two consecutive tests with tuberculin, applied at intervals of not less than six months, the first interval dating from the time of removal of the tuberculous animals from the herd.

5. Prior to each tuberculin test satisfactory evidence of the identity of the registered animals shall be presented to the inspector. Any grade cattle maintained in the herd, or associated with animals of the herd, shall be identified by a tag or other marking satisfactory to the State and Federal officials.

6. All removals of registered cattle from the herd, either by sale, death, or slaughter, shall be reported promptly to the said State or Federal officials, giving the identification of the animal and, if sold, the name and address of the person to whom transferred. If the transfer is made from the accredited herd to another accredited herd, the shipment shall be made only in properly cleaned and disinfected cars. No cattle which have not passed a tuberculin test approved by the State and Federal officials shall be allowed to associate with the herd.

7. All milk and other dairy products fed to calves shall be those produced by an accredited herd, or, if from outside or unknown sources, they shall be pasteurized by heating to not less than 150° F. for not less than 20 minutes.

8. All reasonable sanitary measures and other recommendations by the State and Federal authorities for the control of tuberculosis shall be complied with.

9. Cattle from an accredited herd may be shipped interstate, by certificates obtained from the office of the State live-stock sanitary officials of the State in which the herd is located or from the office of the Bureau of Animal Industry, without further tuberculin test for a period of one year, subject to the rules and regulations of the State of destination.

10. Strict compliance with these methods and rules shall entitle the owners of tuberculosis-free herds to a certificate—"Tuberculosis-Free Accredited Herd"—to be issued by the Bureau of Animal Industry and the State live-stock sanitary authority. Said certificate shall be good for one year from date of test unless revoked at an earlier date.

11. Failure on the part of owners to comply with the letter or spirit of these methods and rules shall be considered sufficient cause for immediate cancellation of cooperation with them by the State and Federal officials.

BREEDERS FAVOR THE PLAN.

The idea and advantages of accrediting herds of cattle found to be free from tuberculosis has gained wide publicity and popularity among cattle breeders during the first year's work. They appreciate the fact that a certificate of approval indorsed by the State in which the herd belongs, and the further indorsement by the United States Department of Agriculture, give prospective purchasers confidence that the animals are free from the disease, and they are in consequence willing to pay a considerable advance in price for such animals.

During the first year's operations, 296 herds, comprising 9,284 cattle, have been fully accredited as free from tuberculosis, and 1,462 herds having 35,052 cattle passed one successful test in preparation for certification. In addition, 4,622 herds, both pure-bred and grade, totaling 98,002 animals, have been under supervision for the eradication of tuberculosis. Each month a large number of additional herds are taken under supervision.

List No. 1 of herds officially accredited as free from tuberculosis, and of herds that have passed one successful test with a view to certification, was issued in pamphlet form, and 50,000 copies have been distributed to cattle owners throughout the country. It is proposed soon to revise the list and publish list No. 2, which will contain the names of the owners of the additional herds that have been fully accredited, as well as those that have passed one successful test.

Tuberculosis-eradication work is being carried on in more than 40 States in cooperation with the State live-stock sanitary officials and the stock owners. Joint agreements between the States and the Bureau of Animal Industry, governing the

application of the tuberculin test and the handling of the herd of cattle, are forwarded to each owner interested in having his herd freed of tuberculosis or in having it accepted as officially accredited. Applications for the joint agreement may be made to the proper State sanitary official or to the Bureau of Animal Industry, Washington, D. C.

INSPECTORS IN CHARGE, TUBERCULOSIS ERADICATION DIVISION.

The following are the names of officials whom live-stock men may consult regarding tuberculosis problems:

Station.	Inspector.	Address.	States under supervision.
Albany, N. Y.	Dr. H. B. Leonard	Care Dr. J. G. Wills, chief veterinarian.	New York.
Albuquerque, N. Mex.	Dr. F. L. Schneider	P. O. box 464.	New Mexico.
Atlanta, Ga.	Dr. Wm. M. MacKellar.	526-29 Federal Building.	Georgia.
Birmingham, Ala.	Dr. R. E. Jackson .	1108 Jefferson County Savings Bank.	Alabama.
Bismarck, N. Dak.	Dr. H. H. Cohenour.	349 Federal Building. . . .	North Dakota.
Boston, Mass.	Dr. E. A. Crossman.	2001-2 Customhouse Building.	Maine, New Hampshire, Massachusetts, Rhode Island, and Connecticut.
Chicago, Ill.	Dr. J. J. Lintner . . .	316 Exchange Building, Union Stock Yards.	Illinois.
Clarksburg, W. Va.	Dr. W. R. Van Ness.	400 Buckhanon Avenue.	West Virginia.
Columbia, S. C.	Dr. W. K. Lewis. . .	901-2 Union National Bank Building.	South Carolina.
Denver, Colo.	Dr. W. E. Howe. . . .	444 Post Office Building.	Colorado and Wyoming.
Des Moines, Iowa.	Dr. F. H. Thompson.	Room 18, Federal Building.	Iowa.
Fort Worth, Tex.	Dr. H. Grafke.	606 Flatiron Building . . .	Texas.
Harrisburg, Pa.	Dr. P. E. Quinn	State Live Stock Sanitary Board.	Pennsylvania.
Helena, Mont.	Dr. Rudolph Snyder.	P. O. box 844.	Montana.
Indianapolis, Ind.	Dr. J. E. Gibson	308 Hume - Mansur Building.	Indiana, Ohio, and Kentucky.
Jackson, Miss.	Dr. J. A. Barger	605 Millsaps Building, Capital and Roach Streets.	Mississippi.
Jefferson City, Mo.	Dr. Ralph Graham	P. O. box 59.	Missouri.
Lansing, Mich.	Dr. T. S. Rich.	Old State Block.	Michigan.
Lincoln, Nebr.	Dr. S. E. Cosford. . . .	414 Federal Building. . . .	Nebraska.
Little Rock, Ark.	Dr. M. Gregory	312 Gazette Building. . . .	Arkansas.
Madison, Wis.	Dr. J. S. Healy.	Care Commissioner of Agriculture, State-house.	Wisconsin.
Montpelier, Vt.	Dr. A. J. De Fosset	do.	Vermont.
Nashville, Tenn.	Dr. W. B. Lincoln.	Care Neuhoﬀ Abattoir & Packing Co.	Tennessee.
New Orleans, La.	Dr. R. W. Tuck	323-4 Post Office Building.	Louisiana.
Oklahoma, Okla.	Dr. W. C. Drake, jr.	Department of Agriculture, Capital Building.	Oklahoma.
Pierre, S. Dak.	Dr. J. O. Wilson.	309 Federal Building. . . .	South Dakota.
Portland, Oreg.	Dr. S. B. Foster.	402 Customhouse Building.	Oregon and Washington.

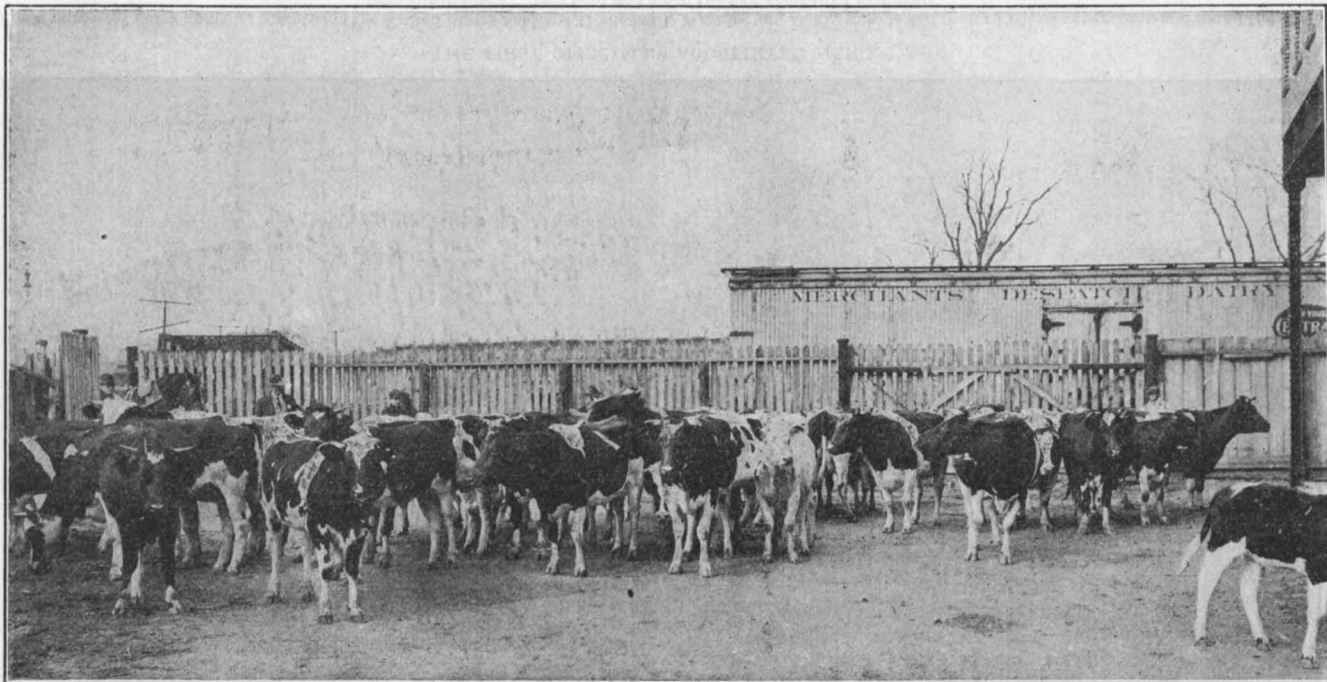

WHERE APPEARANCES ARE UNRELIABLE.

Every animal in this picture had tuberculosis, as indicated by the test and confirmed by post-mortem examination. The original herd of 66 head was found to contain 57 reactors, of which 40 are shown. The appearance of cattle is an unreliable indication of their freedom from tuberculosis.

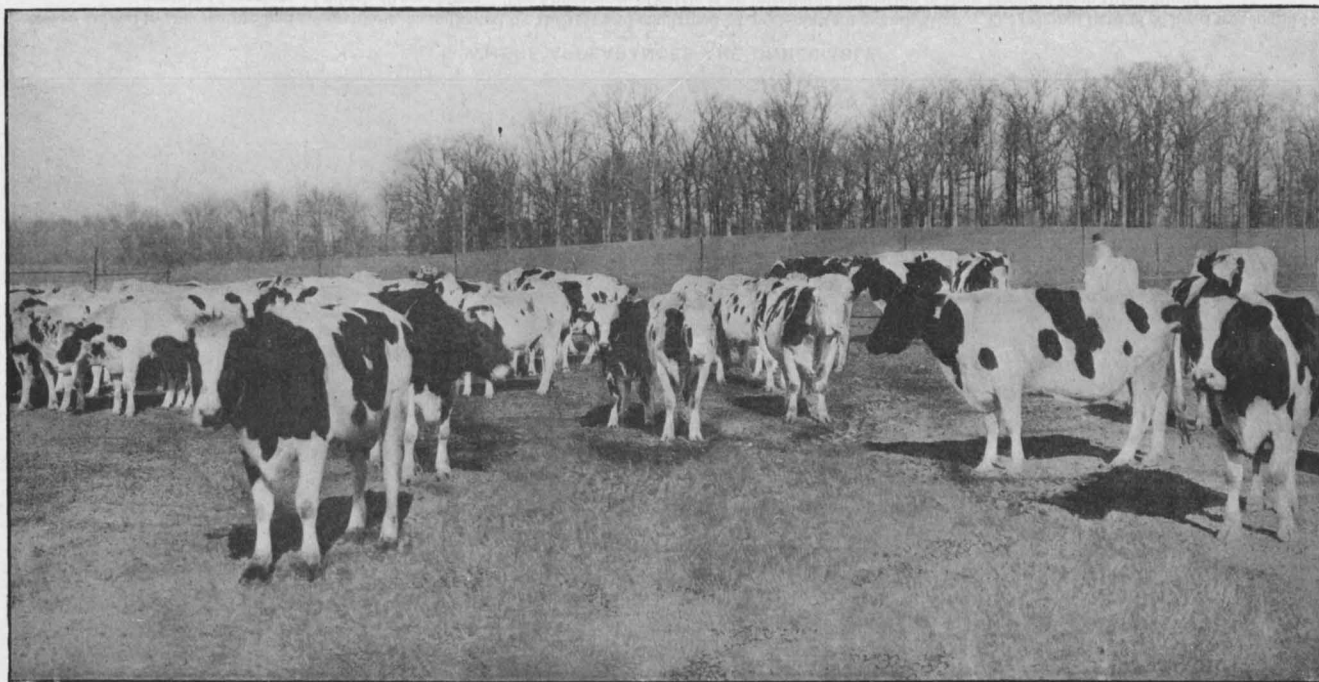

THE FIRST OFFICIALLY ACCREDITED HERD.

These pure-bred dairy animals, comprising the United States Soldiers' Home herd, Washington, D. C., were tested under Federal supervision and found to be free from tuberculosis. This herd was given the first accredited certificate.

Station.	Inspector.	Address.	States under supervision.
Richmond, Va.....	Dr. R. E. Brookbank.	418 Lyric Building.....	Virginia and North Carolina.
Sacramento, Calif.....	Dr. A. J. Payne...	310 Federal Building.....	California.
St. Paul, Minn.....	Dr. W. J. Fretz...	4, 5, 6 Army Building.....	Minnesota.
Salt Lake City, Utah.....	Dr. F. E. Murray..	326 Federal Building.....	Utah, Nevada, and Idaho.
Tallahassee, Fla.....	Dr. J. G. Fish.....	P. O. box 467.....	Florida.
Topeka, Kans.....	Dr. B. W. Murphy...	22 Federal Building.....	Kansas.
Trenton, N. J.....	Dr. W. G. Middleton.	Statehouse.....	New Jersey and Delaware.
Washington, D. C.....	Chief, Bureau of Animal Industry.	Washington, D. C.....	Maryland and District of Columbia.

DETECTION OF TUBERCULOSIS DIFFICULT.

It has been found by very careful experiments and practical work that tuberculosis can not be detected to any great extent among animals by a physical examination. Herds which seem apparently healthy may be extensively affected with tuberculosis. The most reliable method for definitely determining whether tuberculosis exists is the tuberculin test applied by a trained operator. Tuberculin, while it is the most accurate diagnostic agency known to science, is safe only in the hands of a trained and skillful operator who is acquainted with its limitations and with the symptoms it produces in the animals to which it is applied.

Plates XXXIII and XXXIV offer a convincing demonstration of the fact that tuberculosis can not be diagnosed by the unaided eye. Plate XXXIII shows a pure-bred Holstein-Friesian herd apparently in good health, but upon the application of the tuberculin test 57 animals out of a total of 66 were found to be diseased. When the animals were slaughtered, the diagnosis of tuberculosis was confirmed in all cases by post-mortem evidence of the disease. Plate XXXIV shows a herd of pure-bred Holstein-Friesian cattle in which no case of tuberculosis has been found for a number of years. All animals which die in the herd from other causes are carefully examined after death, and all that are killed for one reason or another are subjected to post-mortem examination.

FUTURE EXTENSION OF THE WORK.

It is proposed to carry on the accredited-herd plan until practically all pure-bred herds of cattle in the United States are under State and Federal supervision for the eradication

of tuberculosis. Thus it will be possible for an owner in one State to purchase cattle in another State with the assurance that he will receive animals that may be introduced into his herd with perfect safety so far as tuberculosis is concerned. Under former conditions, many such animals proved to be a menace in place of an asset.

In addition to the accredited-herd plan, the eradication of tuberculosis from live stock will be carried on in circumscribed areas comprising one or more counties. The disease will be eliminated from cattle and swine in such areas, and the campaign extended until it takes in entire States.

In order that the work may progress satisfactorily, it is necessary that live-stock owners cooperate to the fullest extent. The success of the movement for eradicating tuberculosis rests upon the live-stock owners of the country to a greater degree than on any other force; whenever they are ready and willing to "get behind" the work success is bound to follow.

ELECTRIC LIGHT AND POWER FROM SMALL STREAMS.

By A. M. DANIELS,

*Assistant Mechanical Engineer, Division of Rural Engineering,
Bureau of Public Roads.*

LATENT SOURCES OF WATER POWER.

SCATTERED throughout the country are innumerable brooks and small streams, some not wider than a few feet, which at first sight may appear totally insufficient to produce power for practical purposes, but which, upon examination and development, may be made to supply enough power for all farm and domestic needs.

A stream 10 feet wide with an average depth of 2 feet and flowing at the rate of 2 feet per second under a head of 5 feet is capable of supplying over 10 horsepower. This is sufficient to light the average farmstead and have enough current left over to operate motors for many of the regular needs for power on the farm. If the head could be made 10 feet instead of 5, the horsepower could be doubled. Or, if the stream were twice as wide or twice as deep with but a 5-foot head the result would be the same.

The desirability of a dependable, convenient, and cheap supply of electric current for use for light and power purposes on country places is so manifest that one usually is justified in going to some length to secure it. But as the development of a stream for power necessarily must be attended with expense, it is important that consideration be given to the various phases of the problem before any actual work is done.

Electricity available for farm and domestic uses benefits the farmer no more than the wife, who is relieved of much of the drudgery of housework. His needs and her needs go hand in hand, so together they must decide upon the size of plant.

Too much emphasis can not be laid upon the advisability of putting in a plant larger than the needs of the moment seem to require. An additional horsepower or two will not

greatly change the first cost, while use will always be found for any original excess.

A plant capable of furnishing as many as 50 to 100 lights for the house, barn, outbuildings, yard, and drives; providing ample current for washing, ironing, vacuum cleaning, electric fans, toaster, percolators, hot plates, sewing machine, etc.; for all cooking, heating of water and the house in the coldest weather, as well as for operating motors for all the various farming operations even during thrashing time, necessarily must be considered the exception. Such a plant would be in the reach of only a few. On the other hand, the exceptional plant also may be considered to be one the limit of whose capacity will be but 8 or 10 lights.

PLANTS WITHIN REACH OF THOUSANDS.

Between these two extremes, there exist to-day on our farms the means of developing thousands of plants large enough to supply between 5 and 10 horsepower during all seasons of the year. It is to this happy medium that we must direct our attention, for by disregarding the possibility of heating the house and supplying current for large power requirements, it will be found that such a plant will fill the needs of the average farm even with an excess for emergencies. Its cost may be considered well within the reach of thousands of owners to-day.

ESTIMATING THE AMOUNT OF POWER REQUIRED.

There is misconception, however, in the minds of many as to the power that may be obtained from a flowing stream, nor does the average person have any idea what amount of power may be needed. Consequently, the initial step in the problem is first to estimate as correctly as possible the amount of power required for all purposes, and, second, to make a preliminary survey to determine just how much power reasonably may be expected from the stream.

LIGHTING REQUIREMENTS.

The unit of electrical power is known as the "watt," consequently, the estimate of requirements should be made in terms of "watts." Lighting may be taken up first. A list should be prepared showing the location, number, and size

of all desired lights in the house, outbuildings, barns, and driveways. The sizes of lamps usually installed are 25 to 40-watt and for the ordinary room it is customary to figure 2 to 4 of the 40-watt size. Lamps are obtainable in larger sizes, for instance, 60, 80, and 100-watt and upward, but with the possible exception of the 60-watt, they are seldom, if ever, used in private dwellings. The following estimate for lighting, which, of course, must be varied for each individual case, is offered merely as a guide.

Guide for making lighting requirement estimate.

HOUSE.

Place of use.	Number and size of lamps.	Total watts.
Living room:		
Reading lamp.....	3 40-watt.....	120
Ceiling or wall fixtures.....	5 40-watt.....	200
Dining room, ceiling fixtures.....	3 40-watt.....	120
Kitchen.....	2 40-watt.....	80
Pantry.....	1 40-watt.....	40
Bedroom.....	2 40-watt.....	80
Bedroom.....	2 40-watt.....	80
Bedroom.....	2 25-watt.....	50
Bedroom.....	2 25-watt.....	50
Bathroom.....	1 40-watt.....	40
Hall, downstairs.....	2 40-watt.....	80
Hall, upstairs.....	2 40-watt.....	80
Cellar.....	2 40-watt.....	80
Porch.....	1 40-watt.....	40
Attic.....	1 40-watt.....	40
Woodshed.....	1 40-watt.....	40
Miscellaneous.....		200
Total for house.....		1,420

OUTBUILDINGS.

Barn, horse.....	4 40-watt.....	160
Barn, cow.....	4 40-watt.....	160
Barn, hay.....	2 40-watt.....	80
Pig house.....	1 40-watt.....	40
Chicken house.....	4 40-watt.....	160
Watering trough.....	1 60-watt.....	60
Barn-yard entrance.....	1 100-watt.....	100
Front gate.....	1 100-watt.....	100
Miscellaneous.....		200
Total for outbuildings.....		1,060
Total for farmstead.....		2,480

It should be remembered that probably not more than one-half (which is quite liberal) of the lights will be in use at the same time, yet as rare occasions do occur, it is well to figure the plant as capable of permitting the maximum demand.

REQUIREMENTS FOR HOUSEHOLD APPLIANCES.

The estimate of consumption for motors such as are used for washing machines, cream separators, and for other small power purposes, as well as those of larger sizes, may be approximated on the following basis:

Approximate consumption of electricity for small motors.

Horsepower.	Watts.	Horsepower.	Watts.
$\frac{1}{2}$	100	$\frac{3}{4}$	348
$\frac{3}{4}$	202	1	515
1	288		932

Approximate consumption of electricity for household appliances.

Device.	Watts.	Device.	Watts.
8-inch electric fan.....	20	4-pound polishing iron.....	250
12-inch electric fan.....	40	Toaster.....	400
16-inch electric fan.....	70	4-inch disk heater.....	450
3-pound flatiron.....	250	6-inch disk heater.....	600
6½-pound flatiron.....	525	Coffee percolator.....	500
9-pound flatiron.....	650	Small hot-water boiler heater.....	1,500

In preparing an estimate of this nature, it is well to be liberal, for, as the advantages and conveniences of electric current are realized, more is almost sure to be desired than at first thought. After all lights and other uses have been enumerated with their corresponding "watts" consumption, the sum total of power units may be obtained. This figure, if divided by 746, which is the number of watts equivalent to one horsepower, will give the horsepower required for the enumerated uses.

ALLOWANCE FOR FARM MACHINES.

To uses already listed should then be added the horsepower requirements for all other machines used about the farm.

Of course, not all of these machines will be in use at one time, and many of them infrequently, but the capacity of the plant should exceed the requirement of the machine having the highest horsepower rating. As a help in this connection, the following figures are offered:

Power required to operate different farm machines.

Device.	Horse-power.	Device.	Horse-power.
Cream separator.....	$\frac{1}{2}$	Corn sheller.....	$\frac{1}{2}$
Milking machine.....	$\frac{1}{2}$	Hay press.....	3
Wood saw.....	3	Thrashing machine.....	30
Washing machine.....	$\frac{1}{2}$	Churn.....	$\frac{1}{2}$
Grindstone.....	$\frac{1}{2}$	Ice cream freezer.....	$\frac{1}{2}$
Ensilage cutter.....	10	Water pump ¹	1 $\frac{1}{2}$ to 3 $\frac{1}{2}$
Feed grinder.....	5		

¹ This is really dependent upon the lift, but generally may be estimated safely within the above limits.

TOTAL REQUIREMENT.

By adding the total horsepower obtained above to that required for such other farm needs, the grand total or horsepower required is obtained. Thus having answered the question, "How much power shall I require?" we must seek to find out "How much may be reasonably sure of being obtained from the stream?"

WATER-POWER PRINCIPLES.

Two main factors determine the amount of power which may be obtained from a stream: First, the volume of water available, and, second, the "head" or "fall" which this water may have or be made to have. It is desirable that the amount of water flowing in the stream be obtained as accurately as possible. A mere superficial examination should never be considered sufficient, for by so doing disappointment may result. It is not a difficult matter to "measure a stream," but before taking up a description of the two common methods employed, it is desirable to understand in a general way the principles underlying usage of water for power purposes.

If a substance having weight passes from one level to a lower one, energy is released. This energy, under favorable conditions, may be converted into mechanical power to serve a useful purpose. The amount of energy which may be obtained may readily be understood to depend upon or be proportional to two things, first, the weight of the body or substance, and, second, the vertical distance through which it travels from the higher to the lower elevation. Therefore we may say that energy is equal to the weight of the substance multiplied by the vertical height traversed. It is customary to express the weight in pounds and the height in feet; consequently, the product of these two quantities will give the energy in units of foot-pounds.

For a continuous delivery of energy there must be a continuous passage from the higher to the lower level of bodies or substances, each having an appreciable weight. This condition is fulfilled admirably in the case of a stream of flowing water. A spot on the stream may be located and called *supply* and another spot a few feet downhill in the same stream called *power*. Then, every pound of water that falls between these two points and is made to escape through the revolving blades of some type of water wheel, is capable of doing work in terms of foot-pounds. The power (and it should be understood that power is the rate of doing work and not the amount of work that may be done) which this stream may be capable of developing is the rate at which the energy is delivered. It, therefore, depends upon the quantity of water flowing continuously and the height through which it falls. This height is the difference in elevation between the upper surface and the lower position, *measured vertically*. Theoretically, it makes no difference in what path the water flows in passing from the higher to the lower level nor how long the path may be, the vertical height of the upper surface above the lower level is the useful "fall." This height is called the "head."

We can, therefore, understand that our first considerations in the development of a stream as a source of energy for the production of electricity will be to determine the weight of falling water by measuring the quantity flowing and the available head through which this weight may be made to act.

MEASURING THE STREAM FLOW.

While the measurement of a stream should be accurate, yet attempts at extreme accuracy in flow measurements for water-power development should not be attempted, as it would be a waste of time and energy, since the flow of streams varies from day to day, season to season, and year to year.

Measurement of a stream discharge for one day, without data as to the flow on other days and seasons, may be worth very little. The most important records are those taken at low-water stages. For important installations gauge readings are taken daily or oftener for a long period of time and discharge measurements covering various, high, low, and intermediate stages of the stream are made, to the end that the flow throughout the year may be determined. Such records, taken in connection with the rainfall statistics of the catchment area, afford reasonable assurance of what yields or discharge may be expected for water power purposes.

If, however, it is possible to make only a few measurements, the relative flow to be expected at other times of the year should be learned as fully as possible from people who have lived in the neighborhood of the stream and therefore have a rather clear idea as to low and high water in it. When one is positive that a stream is lower than it has been for many years, it is the best time to obtain an idea of its possibilities under the least favorable conditions.

There are two methods by which almost anyone can make a "stream measurement"—the cross-section and velocity method and the weir method. The latter method involves greater cost at the outset than the former, but is more accurate and more convenient in operation.

CROSS-SECTION AND VELOCITY METHOD.

To employ the cross-section and velocity method, select two points along the stream. These may be 50 feet apart in slow streams and from 100 to 200 feet in swift ones. They should be located somewhere along the stream where it is straight, of uniform cross-section, and without cross-currents, back water, or broils.

Plant two range poles, one on each side of the stream, at the upper end of the stretch, and two poles at the lower end, so that an imaginary line joining the poles on opposite banks will cut the stream at right angles to its direction of flow. Measure accurately with a tape the distance between these stations on both sides of the stream and average the two measurements better to approximate the water distance. To obtain the velocity of the stream use a float, such as a round billet of wood about 4 inches to 6 inches in diameter and 3 to 8 inches long. If the depth of water justifies it or if available, use a spherical float, as it is less affected by the wind. An orange serves the purpose very well, as it is easily distinguished in the stream by its color. Weights should be fastened to one end of the piece so that it will float vertically, with one end submerged and the other projecting an inch or two above the surface of the water. If a wooden block is used, the position of the float may be observed more readily from the bank if a small piece of red cloth be fastened to it. The float is put into the water a sufficient distance above the upper line of range poles so that by the time it has reached the upper line it will have attained the velocity of the stream.

An observer at the upper poles sighting from one range pole to the other on the opposite bank should note the time that the float passes his station line, while the lower observer sighting across the lower range poles should catch the time that the float passes his station line. Often one person can make both observations. The difference in seconds between these "times" will give the time required for the float to traverse the measured distance between the upper and lower range poles. If the distance, expressed in feet, be divided by the time, expressed in seconds, the surface velocity in the path of the float in feet per second will be obtained.

Several trials should be made, and at various distances from midstream to each shore. The "times" should be added and divided by the number of trials to obtain the average time required for the float to pass between the two stations. Since the velocity varies at different depths and

at different distances from the thread of the stream, the mean velocity may be considered eight-tenths of the surface velocity.

After having obtained a value for the mean velocity of the stream, the next step is to estimate the stream cross-section at the range-pole lines. If the channel is not fairly uniform in cross-section, the determination of the sectional area at several intermediate points should be made.

Stretch across the stream a measuring tape or cord with tags tied at measured intervals, say 2 feet apart, the first tag on each side being 1 foot from the edge of the water, so that the sum of these two will equal the distance between any two of the other tags. Next measure the depth of water

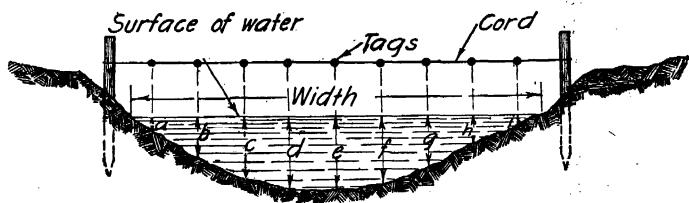

FIG. 10.—Cross-section method of measuring a stream flow. A cord with tags fastened at measured and equal intervals is tied to stakes on each side of the stream. The depth of water at each tag is measured and from these measurements the cross-sectional area of the stream is determined.

in feet or parts of a foot at each of the tags as at *a*, *b*, *c*, etc., figure 10. Add $1\frac{1}{2}$ times the depth taken nearest each bank, as at *a* and *i* in figure 10, and 2 times the depth at all intermediate points, as, for instance, *b*, *c*, *d*, *e*, *f*, *g*, and *h*. The sum will be the cross-sectional area of the stream within the limits of the number and the accuracy of the measurements.

This should be done for the section at both the upper and lower range-pole lines. The values for each, added and divided by 2, will give an average working value for the area. Having now obtained the cross-section of the stream in square feet, and also the average or mean velocity of the stream in feet per second, the product of these two multiplied by 60 will give the quantity of water in *cubic feet per minute* that the stream furnishes.

WEIR METHOD.

In figure 11 is shown a weir which consists of a board long enough to reach across the stream with each end set in the bank. A notch is cut in the board deep enough to pass all the water and long enough to reach about two-thirds across the stream. When installing a weir the following points should be observed, for each has a direct bearing upon the efficiency of the weir:

1. On the upstream side the water must approach the weir with exceeding slowness. This usually makes it necessary to widen and



FIG. 11.—The weir method of stream measurement. A board is set across the stream, with a notch cut deep enough to pass all the water. Measurements are taken at a stake, E, and from these the quantity of water can be determined by means of a table given in the text.

deepen and frequently to lengthen the channel of approach so that practically a still-water condition exists adjacent to the weir.

2. The notch B in the board should be beveled about 45 degrees on the downstream side; the ends of the notch should also be beveled on the same side and within one-eighth of an inch on the upper side, leaving the whole upper edge of the notch almost sharp.

3. The distance from the bottom of the stream to the bottom of the weir should be at least three times the depth of water on the weir, also the distance of the ends of the bottom of the notch from the banks should be at least twice the depth on the weir.

4. The length of opening across the stream perpendicular to the current should be three or four times the depth of the water on the weir.

5. The water as it flows over the weir should be free to fall without touching the walls below the weir or any obstruction which would not permit free circulation of air underneath the falling waters.

6. The depth of the water should be measured with accuracy from a stake, E, figure 11, located several feet back from the weir. This stake should be driven until the top of it is exactly level with the bottom of the weir notch.

7. The bottom of the notch should be exactly horizontal and the sides should be vertical.

Having observed the above points and being sure that everything is in proper order, a reading may be taken by placing a rod with inches and fractions of an inch marked on it, on the top of stake E, and noting at what height on the rod the water stands. Then, by means of the accompanying weir discharge table, the quantity of water flowing over the weir for any given period of time may be obtained.

The figures 1, 2, 3, etc., in the first vertical column of this table indicate the inches depth of water running over the weir-board notches. Frequently the depths measured represent also fractional parts of an inch between 1 and 2, 2 and 3, and so on. The horizontal line at the top represents these fractional parts and can be applied between any of the numbers. The body of the table shows the cubic feet and the fractional parts of the cubic foot which will pass each minute for the depth read. Each of these results is for only 1 inch length of weir. To estimate, therefore, for any length of weir, the result obtained for 1 inch width must be multiplied by the number of inches constituting the whole horizontal length of weir.

For example, suppose the notch in the weir shown in figure 11 is 20 inches long and the water over the stake E measures $5\frac{1}{2}$ inches depth to the surface. Take the figure 5 in the first vertical column and follow the horizontal line of figures until the vertical column, containing $\frac{1}{2}$ at the top, is reached. The figure given in the column is 5.18 cubic feet. This is the quantity of water passing per minute for each inch in length and $5\frac{1}{2}$ inches deep. The weir, though, is 20 inches long; therefore, this result must be multiplied by 20, which gives 103.6 cubic feet per minute.

Weir discharge table.

[Flow in cubic feet of water per minute for each inch in length of weir and for depths from $\frac{1}{8}$ inch to $24\frac{7}{8}$ inches.]

Inch.	0	$\frac{1}{8}$	$\frac{1}{4}$	$\frac{3}{8}$	$\frac{1}{2}$	$\frac{5}{8}$	$\frac{3}{4}$	$\frac{7}{8}$
0	0.01	0.05	0.09	0.14	0.20	0.26	0.33
1	0.40	.47	.55	.65	.74	.83	.93	1.03
2	1.14	1.24	1.36	1.47	1.59	1.71	1.83	1.96
3	2.09	2.23	2.36	2.50	2.63	2.78	2.92	3.07
4	3.22	3.37	3.52	3.68	3.83	3.99	4.16	4.32
5	4.50	4.67	4.84	5.01	5.18	5.36	5.54	5.72
6	5.60	6.09	6.28	6.47	6.65	6.85	7.05	7.25
7	7.44	7.64	7.84	8.05	8.25	8.45	8.66	8.86
8	9.10	9.31	9.52	9.74	9.96	10.18	10.40	10.62
9	10.86	11.08	11.31	11.54	11.77	12.00	12.23	12.47
10	12.71	12.95	13.19	13.43	13.67	13.93	14.16	14.42
11	14.67	14.92	15.18	15.43	15.67	15.96	16.20	16.46
12	16.73	16.99	17.26	17.52	17.78	18.05	18.32	18.58
13	18.87	19.14	19.42	19.69	19.97	20.24	20.52	20.80
14	21.09	21.37	21.65	21.94	22.22	22.51	22.79	23.08
15	23.38	23.67	23.97	24.26	24.56	24.86	25.16	25.46
16	25.76	26.06	26.36	26.66	26.97	27.27	27.58	27.89
17	28.20	28.51	28.32	29.14	29.45	29.76	30.08	30.39
18	30.70	31.02	31.34	31.66	31.98	32.31	32.63	32.96
19	33.29	33.61	33.94	34.27	34.60	34.94	35.27	35.60
20	35.94	36.27	36.60	36.94	37.28	37.62	37.96	38.31
21	38.65	39.00	39.34	39.69	40.04	40.39	40.73	41.09
22	41.43	41.78	42.13	42.49	42.84	43.20	43.56	43.92
23	44.28	44.64	45.00	45.38	45.71	46.08	46.43	46.81
24	47.18	47.55	47.91	48.28	48.65	49.02	49.39	49.76

FINDING THE HORSEPOWER AVAILABLE.

Having now means for obtaining the quantity of water flowing, the next step is to find, by determining the head, the horsepower available, or perhaps a better way is to calculate the head necessary with the volume of water available to give the horsepower that was estimated as needed, and then see if it can be obtained.

As stated, the power of falling water is directly proportional to the head and quantity. Thus, if the measurement of a stream, by either of the methods described, showed 189 cubic feet of water flowing per minute, and as water weighs approximately $62\frac{1}{2}$ pounds per cubic foot, the total weight of water flowing per minute is equal to 189 cubic feet multiplied by 62.5 pounds or 11,812.5. If this weight were dropped 1 foot, $11,812.5 \text{ pounds} \times 1 \text{ foot} = 11,812.5 \text{ foot}$

pounds of energy would be liberated. If it were dropped 3 feet we would have $11,812.5 \times 3 = 35,437.5$ foot pounds. As 1 horsepower is equivalent to 33,000 foot-pounds exerted for 1 minute, if we divide the 35,437.5 foot-pounds by 33,000 we get 1.07 horsepower.

As the work to be obtained from this water varies directly as the head and as the quantity, it is evident that a stream one-half as big that is supplying only 95 cubic feet per minute but falling twice as far, or 6 feet, will also give 1 horsepower at the wheel; or a stream of 189 cubic feet per minute falling ten times as far, 30 feet, would give ten times the power, or 10 horsepower; or for 100 feet fall, 100 horsepower would be available at the wheel. Consequently, small quantities of water falling great distances, or large quantities falling small distances, may accomplish like results. Therefore we may say that the theoretical horsepower from a flowing stream is equal to the product of the cubic feet per minute multiplied by head in feet multiplied by 62.5 (weight of 1 cubic foot of water), and divided by 33,000.

As an example, suppose a weir 36 inches long had a depth of water on it of $8\frac{1}{2}$ inches and we wish to know what horsepower may be delivered at the wheel if the maximum head that can be obtained is 12 feet. Referring to the weir-discharge table, we read, for a depth of $8\frac{1}{2}$ inches of water on the weir, a quantity of 9.96 cubic feet per minute. Multiplying this by 36, the length of the weir expressed in inches, we find a total of 358.56 cubic feet of water per minute available. This multiplied by 12 (the head) and 62.5 (the weight) and the result divided by 33,000, gives 8.15, the theoretical horsepower. To determine the actual horsepower, the efficiency of the water wheel must be taken into consideration. This will vary with the type of wheel, but a 50 per cent loss may be assumed in making rough estimates. Under this assumption, the actual horsepower available is one-half of 8.15, or approximately 4 horsepower.

Attacking the problem from another angle—that is, assuming that 5 actual horsepower is required in this case and that the available stream delivers 500 cubic feet of water per minute, what head is required to give this horsepower? As our efficiency is to be considered only 50 per cent, then

the theoretical horsepower that must be available is 5×2 , or 10, in this case. To determine this head, multiply 33,000 by 10 (the desired horsepower) and divide the result by 500 (cubic feet) multiplied by 62.5 (the weight). The result will be 10.6 feet, the necessary head.

The next thing is to find out if conditions are such as to give this head without danger of the water backing up to such an extent that damage may be done to the land above the dam. For this purpose levels should be taken. A "Y" level or an engineer's transit with level attachment and a leveling rod should be used, but, if not available, a carpenter's level may be utilized. Take two poles several feet long and

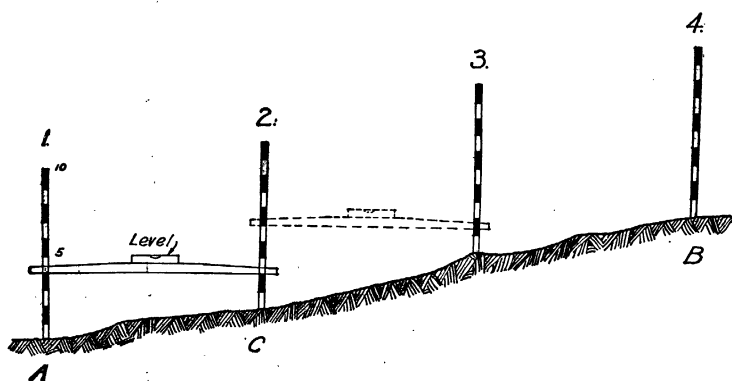

FIG. 12.—A method for finding the distance water will back up from a dam. Two poles marked with feet and tenths of a foot, and a carpenter's level, are used as described in the text.

mark on them feet and tenths of a foot. Suppose the difference in elevation between points A and B, figure 12, on the irregular line which may represent the bed of the stream, is desired. Fasten a carpenter's level to a straight edge and place it against the poles set in position 1 and position 2. Suppose the leveling piece is at the 4-foot mark on the lower and the 2-foot mark on the upper, then the difference in elevation between points A and C will be 2 feet. Now take the first pole and move it upstream to position 3 and repeat the leveling. The straight edge may be placed at any height on the two poles and the difference in reading between the poles will give the rise in the ground between them. When completed, add all the differences and the sum will give the total difference, or the head between A and B, provided the land continually rises between these points.

If this difference was, for instance, found to be 12 feet, then if a dam of this height were to be built at the point A, the water would back up to the point upstream corresponding to a point where B was located. It is this backing up which must be looked into carefully, so that all trouble from damaging property may be avoided.

The bed of every stream not navigable which lies within the boundary lines of the farm is the property of the owner of the farm, and he has certain inherent rights in the use of the water therein. If the stream is navigable or "floatable" (for floating logs) it is considered public property; if not, private. "Riparian" rights refer to rights of the landowner who is the proprietor of land over which water flows or along whose borders it flows. The following quotation is from "Law for the American Farmer," by John B. Green, on "riparian rights":

Water is the common and equal property of every one through whose land it flows, and the right of each landowner to use and consume it without destroying or unreasonably impairing the rights of others is the same. An owner of land bordering on a running stream has a right to have its waters flow naturally, and none can lawfully divert them without his consent. Each riparian proprietor has an equal right with all the others to have the stream flow in its natural way without substantial reduction in volume or deterioration in quality subject to a proper and reasonable use of its waters for domestic, agricultural, and manufacturing purposes, and he is entitled to use it himself for such purposes, but in doing so must not substantially injure others. In addition to the right of drawing water for the purposes just mentioned, a riparian proprietor, if he duly regards the rights of others, and does not unreasonably deplete the supply, has also a right to take the water for some other proper uses.

POWER FROM SMALL STREAMS.

Sometimes the measurement of a stream may show such a small amount of water flowing that it would not be sufficient if the generator were running continuously, but were the water to be impounded for, say, 18 hours, and then this stored water used with the normal flow for the other 6 hours of the day sufficient horsepower could be generated to supply current for evening lighting, and possibly some small power needs. While such a plant may not afford all necessary electric-current supply, in many instances it would appeal as an improvement well worth considering.

Then, again, under some conditions, water may be so scarce that it will have to be stored for 3 or 4 days to get enough power to charge a storage battery to supply current for a few lights for the farmstead to carry over until sufficient water has again been collected to recharge the battery. Even such an arrangement offers decided advantages over kerosene lamps.

It has been the purpose of this short article merely to touch upon the dormant possibilities for electric-power generation on many of our farms and thus create interest in the matter. For those who may wish to do a little prospecting the following method of procedure should help.

Let the farmer and his wife assume that their lighting requirements are the same as enumerated in the guide for a lighting estimate given on page 223, which gives a total of 2,480 watts. For motors and other uses for electric current probably most needed in the house, the following list will serve as a sample:

	Watts.
Electric range oven.....	2, 500
Range hot plates, 4 at 1,000.....	4, 000
Small hot-water boiler heater.....	1, 500
One 3-pound flatiron.....	250
One 6½-pound flatiron.....	525
One toaster.....	400
One hot plate or disk heater.....	600
Coffee percolator.....	500
Two electric fans at 70 watts each.....	140
Sewing machine.....	200
Total	10, 615

Assuming a maximum of 75 per cent in use at any one time, this gives a wattage of 7,962 watts, or, say, 8,000 watts. Adding the 2,480 watts for lighting, they have a total of 10,480 watts for use in the house and for lighting the farmstead. As 746 watts is equivalent to 1 horsepower, they obtain the equivalent horsepower by dividing 10,480 by 746, which gives them 14.18 horsepower. They next enumerate the horsepower required by the farmer as follows:

	Horsepower.
Cream separator.....	0. 50
Churn 50
Milking machine, 2 at 0.5.....	1. 00
Wood saw.....	3. 00

	Horsepower.
Washing machine-----	.25
Grindstone-----	.25
Feed grinder-----	5.00
Corn sheller-----	.50
Hay press-----	3.00
Pump-----	3.5
	<hr/>
Total-----	17.50

From this estimate it will be safe for them to assume that not more than 10 horsepower will be in use at any one time, so that adding this to the above estimate they determine that their generator must be capable of supplying 20 to 25 horsepower, and that, assuming a 50 per cent water wheel efficiency, their stream must show conditions equivalent to developing about 50 horsepower.

With this figure in mind, the farmer must start to "measure" his stream.

No two small hydro-electric possibilities present the same conditions for development. Each must have its own solution in order properly to take advantage, at the least expense, of the opportunity which may be present in a flowing stream of water. A stream on any farm may represent energy running to waste. If properly harnessed, although flowing an apparently insignificant volume, it may, by the use of storage batteries, be capable of supplying all current needed for lighting. It can drive the dynamo and thus generate and store electricity in storage batteries at a low rate for 24 hours a day, while the lighting load, which will draw the current from the storage batteries at a higher rate, seldom extends over a larger period than 5 of the 24 hours. A small waterfall or an old mill site oftentimes offers excellent opportunities for the development of sufficient power to operate even heavy farm machinery.

The power site need not be adjacent to any of the farm buildings; in fact, most frequently it is some distance away, and may even be as far as a mile. The control, however, should be at a convenient point, which is by no means a difficult matter to arrange.

One plant recently inspected by the writer is capable of developing from 4 to 10 horsepower, depending upon the flow of the stream. The switchboard and control are located

in one corner of a frame garage about 50 yards from the residence; the power house is over a quarter of a mile from the residence and on the opposite side from the garage. The dam is about 150 yards upstream from the power house.

This particular plant can very properly be called a home-made one. It was built about 8 years ago and has been out of service only for a short time during a freshet, when the stream rose more than 8 feet. Practically all of the installation work and dam construction was done by the owner of the farm with such help as was available there. The power house frequently is not visited for a week at a time, all regulation, starting up, and closing down being done at the switchboard. It supplies light for the owner's residence, for four tenant houses, distributed over the 140-acre farm, for barn, for garage, and other outbuildings, and current for any one or two of some nine motors located on the place. This service has been secured at practically no cost for upkeep or operation. A low upkeep cost is one of the advantages of a small hydro-electric plant.

The first cost of such plants depends on several factors. Very frequently second-hand equipment may be purchased, which will tend to keep the cost down. The work may be laid out so as to extend the total outlay over a period of time. The plant may be designed and the dam constructed to develop the maximum power available under normal conditions, but the installation and distribution system carried through by degrees, the original work being merely sufficient to take care of the urgent lighting requirements. But, no matter whether an elaborate plant and distribution system, surveyed, designed, and installed by professional hydro-electric engineers, is intended, or whether a rather crude one of but one or slightly more horsepower is all that is feasible, the prime consideration is to utilize energy that may now be going to waste, and thus bring to the farm many of the conveniences that electricity provides.

SOME RESULTS OF FEDERAL QUARANTINE AGAINST FOREIGN LIVE-STOCK DISEASES.

By G. W. POPE,
Quarantine Division, Bureau of Animal Industry.

THE business of animal production in practically all countries is attended with losses from disease sometimes of a most disheartening character. Consequently it is useful to learn how control of these scourges has progressed and to judge how individual effort can supplement and best support official activities.

In view of the serious animal diseases still prevalent in the United States, optimism over present progress of control may seem unwarranted, but considering the foreign animal plagues kept at bay by Federal quarantine, live-stock raisers of the United States enjoy relative security. This safety also may be strengthened by close cooperation with Federal and State officials in reporting and eradicating local outbreaks of all contagion that threatens live stock.

The appearance of tuberculosis in well-established herds of cattle has upset the plans of numerous breeders. Contagious abortion, with its attendant calf pneumonia, and the acute infectious diarrhea of new-born calves have been discouraging to many. Hog cholera has its annual toll and at intervals anthrax appears in certain well-defined areas. Horses have been lost from shipping fever; at times large numbers have died mysteriously from what has been termed "forage poisoning," and we are just beginning to realize that hemorrhagic septicemia, manifested as "stockyards fever" in cattle, "swine plague" in hogs, "fowl cholera" in poultry, and sheep pneumonia with complications, is causing considerable loss.

Such occurrences of disease for the most part, however, have been localized. Many are preventable, and, as in black-leg and hog cholera, losses chargeable to their account are rendered practically negligible through proper vaccination. In fact, the situation in the United States is decidedly encouraging compared with the experience of certain other

countries where destructive animal plagues, that do not exist in this country, have become firmly established, and which, with two exceptions, have never appeared here. The two exceptions are contagious pleuropneumonia of cattle and foot-and-mouth disease. The latter affects principally cattle, sheep, and swine.

NO CASES OF PLEUROPNEUMONIA FOR A QUARTER CENTURY.

It may be safely asserted that not one of the younger generation of live-stock producers in the United States has ever seen a case of contagious pleuropneumonia of cattle. Our veterinarians who have had experience with the disease are limited to the few of the old school who took part in its eradication about 30 years ago. Consequently, there would very naturally be no general appreciation of the great advantage resulting from freedom of this country from the disease.

Those were unfortunate days during the decade beginning about 1840, when, as a result of unrestricted importations of cattle, contagious pleuropneumonia was introduced into New York, Massachusetts, and New Jersey. Not only did it require large expenditure of money and the sacrifice of valuable animals to eradicate the disease, but it was not accomplished completely until 1892, and in the meantime the markets of certain foreign countries had been closed to our cattle.

The only apparent recompense for this unfortunate experience was the organization of a cattle commission of the Treasury Department, the function of which was to stamp out contagious pleuropneumonia and take measures to prevent its further introduction. Later, in 1884, the Bureau of Animal Industry was established under the Commissioner of Agriculture, who took over the work of the Treasury Cattle Commission. Since that time our country has been safeguarded through an established system for the quarantine of ruminants and swine at ports of entry and by restrictions upon importations of live stock in accordance with regulations based upon various acts of Congress. Among them was the act of 1890 prohibiting the importation of neat cattle, sheep, and other ruminants and swine which are dis-

eased or infected with any disease or which have been exposed to any infection within 60 days.

Thus cattle are not permitted importation from any country in which contagious pleuropneumonia exists, and as the quarantine period for import cattle is intended to cover any possible incubative period for such disease, it is not probable that this "lung plague" of the Old World will ever be seen in this country again.

FOOT-AND-MOUTH DISEASE A CONSTANT MENACE.

The other great animal plague of the world which though nonexistent in the United States has made its appearance on several occasions on our shores, is foot-and-mouth disease. Had it not been for the outbreaks of 1902, 1908, and 1914, few indeed of this generation in our country would possess a more than passing knowledge of the disease. However, the outbreak of 1914-1916, which was the most extensive, has given our live-stock growers an opportunity to learn at first-hand something concerning its serious character. It extended into 22 States and the District of Columbia and only through adoption of the most vigorous measures and by the closest cooperation of Federal and State officials was the disease eradicated.

POLICY OF COMPLETE ERADICATION.

During this outbreak many suggestions were made urging less stringent methods than the slaughter of infected animals. Many advocates of these less drastic measures evidently were natives of countries in which foot-and-mouth disease for years had been thoroughly established and its eradication consequently practically impossible. Their early education was in countries where continued existence of the disease was considered a necessary evil, and consequently it was natural for them to reason along this line of least resistance. In some instances those contending for conservation of the life, meat, or hides of affected animals were not aware of the true nature of the disease or were actuated by purely selfish motives.

Failure to eradicate foot-and-mouth disease completely and the continued existence of centers of infection in this

country would have been most unfortunate. Under such circumstances prospects for a growing market in foreign countries for pure-bred animals would have been destroyed. Foreign countries maintaining a competent live-stock sanitary service would have continued in effect their restrictions against importations of our live stock.

A greater and more far-reaching effect, however, would have been felt in connection with our market trade and interstate traffic in live stock. Under such conditions, no breeder wherever located could feel any degree of security; our great stockyards would become possible clearing houses for the infection and our domestic commerce with all concerned therein would be burdened with restrictions made necessary for control of the disease.

Happily, our country is now free from foot-and-mouth disease, but we can claim neither complete security nor immunity. The disease is widespread, prevailing in various parts of Europe, Asia, and South America. It is true the department does not permit the importation of ruminants and swine from any country in which foot-and-mouth disease exists; also in a war measure of August 10, 1918, while providing for admission of tick-infested cattle for immediate slaughter from Central and South America, islands of the Gulf of Mexico, and the Caribbean Sea, Congress very wisely placed a specific prohibition upon any cattle from a country in which foot-and-mouth disease is present.

STRINGENCY OF QUARANTINE RESTRICTIONS.

Nevertheless, our commerce is world-wide, and as indirect transmission plays an important part in the dissemination of that disease, there is greater need than ever for close cooperation between the Federal authorities and importers of hides, wool, and other animal by-products in a strict enforcement of the regulations designed to prevent the importation of any contaminated materials of this kind. These regulations are issued jointly by the United States Departments of Agriculture and the Treasury, and in their enforcement American consuls, stationed at foreign ports under direction of the Department of State, lend cooperation. Restrictions now in effect can not well be more strin-

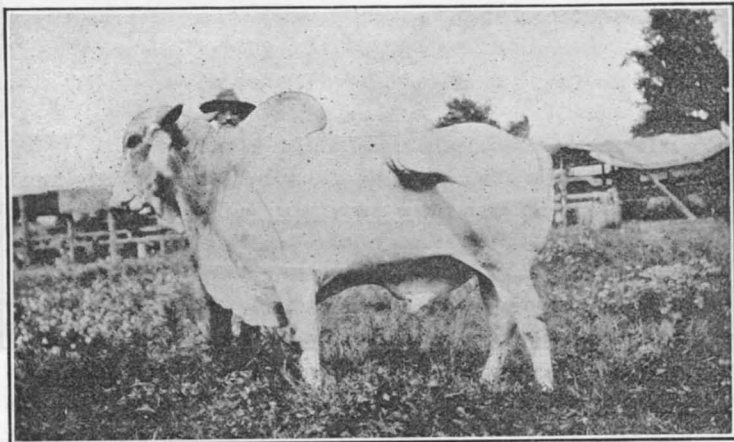

FIG. 1.—ZEBU BULL IN QUARANTINE.

This magnificent animal was a member of an imported herd in which surra was found.

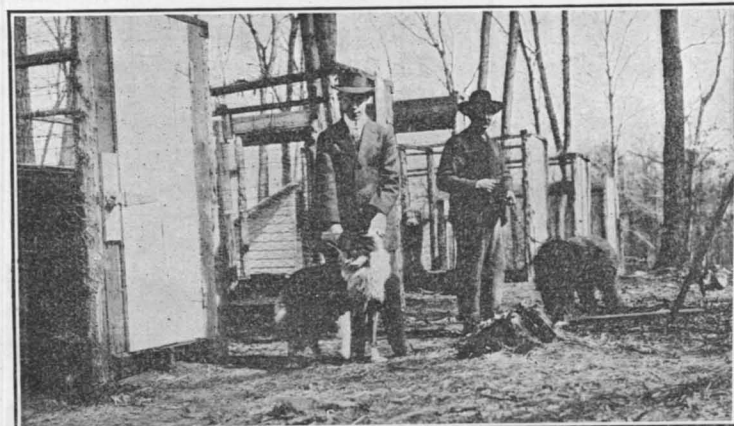

FIG. 2.—QUARANTINE PENS FOR DOGS.

Imported collie, shepherd, and sheep dogs are subject to quarantine to determine their freedom from a tapeworm causing the gid disease in sheep.

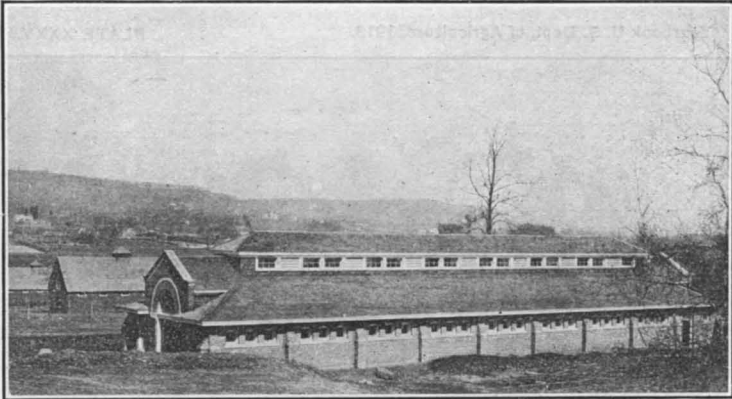

FIG. 1.—FEDERAL QUARANTINE STATION.

The building in the foreground is the type used for quarantining cattle. Pens and buildings are arranged so that outgoing stock do not pass over the same ground as the incoming animals.

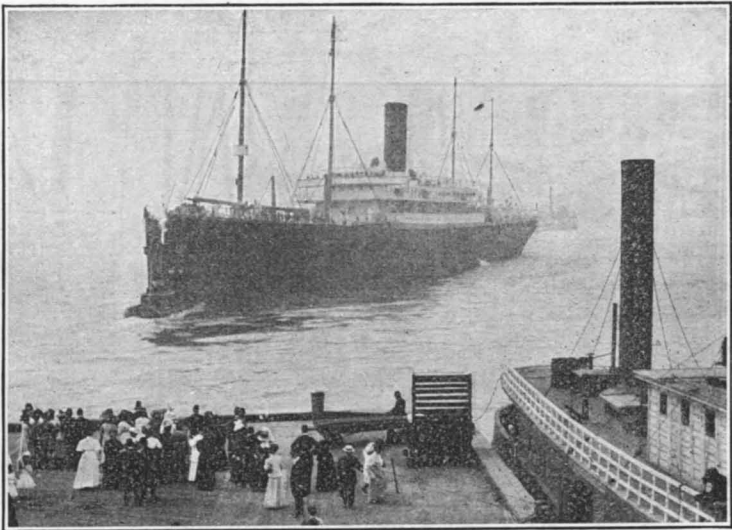

FIG. 2.—A CATTLE-CARRYING OCEAN LINER.

Some passenger vessels have the lower decks especially equipped for carrying live stock. The animals are transferred from the vessel to a barge which takes them to the quarantine station.

gent without operating prohibitively. That in the past they have proved effective is demonstrated by the fact that while on three occasions in the last 17 years foot-and-mouth disease has been introduced into this country, the infection was in no case traceable to animal by-products included under provisions of these regulations.

With a world trade in diversified materials which might possibly be carriers of infection, we may be disappointed but not surprised to find at any time that the disease has reappeared in our country. Its appearance, however, must be the signal for prompt and effective methods—not for control alone, but for eradication. Foot-and-mouth disease should be classed as an undesirable alien enemy.

DISEASED ANIMALS DESTROYED AT QUARANTINE STATION.

Another animal scourge at one time reached the confines of one of the Atlantic coast quarantine stations, where it was promptly detected and the infected animals destroyed without an opportunity to contaminate American live stock. This disease, one of the great plagues of the Orient, is termed surra and is well named; the word signifies "spoiled." The introduction of surra into this country would despoil many a live-stock farm, and once established surra would menace our entire live-stock industry.

As it is caused by a blood parasite transmitted by biting flies, the disease would be difficult to eradicate, especially as cattle frequently may become affected but mildly and still be virus carriers, veritable reservoirs of the infection, and thus be a menace to horses, which are especially susceptible. It is in a large measure owing to the presence of surra in the Philippines and in Asia and Africa that animals from such countries for several years past have been prohibited from importation into the United States by special orders of the Secretary of Agriculture issued under authority of certain specific acts of Congress.

THE TOLL OF RINDERPEST.

Another serious disease of the Eastern Hemisphere is rinderpest. This is one of the words which will drive all but the special student of animal diseases to the dictionary,

for it is seldom spoken or seen in print in our country. As the name signifies, it is a cattle plague.

Recognized in Asia in the early ages, rinderpest extended over the entire Eastern Continent. Its extension into Europe appears to have been associated with the great wars; cattle accompanying troops acted as disseminators of the infection. A study of the history of rinderpest throughout the world indicates that losses resulting from the disease have been enormous. In some countries outbreaks claimed more than a million cattle, or from 3 to 5 per cent of the total stock of the country. Applying such experiences to our own country, with cattle estimated at 68 million head, it will be seen that rinderpest if introduced might cost the United States a loss of more than 3 million valuable animals.

Rinderpest has been driven back from Europe into the Far East. While the virus is conveyed chiefly by means of infected cattle, infected hides, wool, and other materials may have a part in its dissemination. Thus it is necessary that exclusion of animals from countries in which rinderpest exists should be continued and there should be strict adherence to the regulations issued jointly by the Department of Agriculture and the Treasury designed to prevent entrance into the United States of any animal by-products possibly carrying the infection of this disease.

PROTECTION FOR OUR HORSES.

At the present time there exist in Europe two diseases of the lymphatic system of the horse which are not present in the United States. These are the ulcerative and epizootic forms of lymphangitis. Both are chronic contagious diseases caused in the one case by a bacillus and in the other by a fungus organism. In ulcerative lymphangitis, which resembles cutaneous glanders, an animal may continue to be a carrier of the infection for years, infecting the premises and soil and thus acting as a spreader and a menace to other stock. The other form of lymphangitis is attended with a probable mortality of from 7 to 10 per cent and is very protracted in its course. It persists for a period of six months in some cases and after apparent recovery it appears again.

It is doubtful whether the United States has any disease of horses comparable in objectionable features with either form

of lymphangitis described. Probably the war-trodden soil of Europe, upon which thousands of horses from various countries have been in Army operations, may be extensively infected with the causative agents of these diseases; hence the need for special precautions.

Another element of danger is the possible introduction into the United States, with horses or other animals, of certain parasitic carriers of diseases nonexistent in this country. Especially does this hold true of species of ticks carrying such diseases as biliary or so-called malarial fever of the horse and malarial catarrhal fever of sheep. Both of these diseases are caused by blood parasites conveyed through the bite of certain species of ticks. It was this disease of horses in South Africa which, during the Boer War, caused a heavy loss of horse stock shipped to that country from Europe. It has been reported as existing in certain countries of Europe and Asia and is known to be widely spread in Africa. Experience with the cattle tick that carries Texas, tick, or splenetic fever of cattle in our Southern States has taught the great cost of such a pest and emphasizes the necessity of guarding against the introduction into the United States of any similar disease affecting horses or other classes of farm animals.

It is likewise essential that no possible risk be taken of bringing into this country the destructive African horse sickness, known in South Africa for more than a century, causing in some cases a loss of from 66 per cent to 90 per cent of the entire number of horses and mules in the affected locality. Caused, apparently, by some organism which owing to minuteness or for other reasons has never been identified by the highest power of the microscope and transmitted by means as yet not well understood, science is at a disadvantage in dealing with this disease. The introduction of African horse sickness might result in an incalculable loss to the horse industry of our country.

PREVENTION BETTER THAN CURE.

There are other serious foreign diseases of domestic animals, but enough have been mentioned to demonstrate the desirability of placing every possible safeguard about our live stock. Have all the troublesome diseases which afflict

live stock in the United States been imported? This may be as difficult to answer as the query concerning priority in existence of the hen and the egg. That some of these afflictions have been introduced upon this Western Continent with importations of animals made prior to the days of an organized quarantine service is reasonably certain. Some of the diseases are being eradicated systematically, and the cost and effort of eradication certainly lead to the conclusion that the old time-worn adage, "Prevention is better than cure," is exceedingly pertinent and has unusual force in its application to measures taken in connection with the control of animal importations into the United States.

THE THRASHING RING IN THE CORN BELT.¹

By J. C. RUNDLES,

Scientific Assistant, Office of Farm Management.

FARMERS have long recognized the advantage of exchanging help as a means of securing larger crews than the farm affords. The plan of organizing definite thrashing rings or circles, which guarantee those inside the club the amount of help they need, has been tried in different sections of the Corn Belt during the last decade or more. At the same time, cooperative ownership and management of thrashing machinery has been tried with more or less success in many communities.

To learn the facts concerning ring ownership and management of thrashing machines as a scheme for saving labor and money, and to determine the present status of the movement, the writer visited several ring officers in the Middle West to secure first-hand information. Then letters were sent to manufacturers of thrashing machinery, requesting the addresses of ring secretaries who had bought outfits. In this way, over 700 names of ring members were secured, representing all the States of the Middle West. Some of the rings dated back 14 years, but most of them were organized within the last few years. A questionnaire was sent to 300 of these men, calling for information concerning their experience. Most of the 80 replies received came from Ohio, Indiana, Michigan, Illinois, and Iowa, where the results of this investigation are applicable.

OLD METHOD FAULTY.

The old practice of custom thrashing, as commonly followed in the eastern part of the grain belt, is often very unsatisfactory. The outfits competing for the thrashing work of a neighborhood may be inadequate, and some of them may be operated after they are practically worn out. As a re-

¹ Thanks are extended to H. R. Tolley, Office of Farm Management, for criticism and suggestions followed in the preparation of this article.

sult jobs are contracted a long time in advance, irregular runs are necessary, the manner of handling the work is often unsystematic, breakdowns due to poor equipment are frequent, and more or less dissatisfaction is general.

In reply to the question, "Why did you find it advisable to buy an outfit?" the following replies were most frequently given by ring members:

"Hard to get a good rig, and had to wait till it came."

"So we could thrash before our grain spoiled."

"To get our thrashing out of the way of other work."

"To save labor and shorten the thrashing season."

"Few good outfits in our neighborhood."

The first and second replies are the ones usually given, but all of them indicate that the conditions were unsatisfactory before rings were organized, and that the farmers were compelled to act. Cooperation in contracting the jobs of a given neighborhood is essential, otherwise the farmers do not know the plans of the neighbors with whom they exchange labor, and the thrashing rig may come and go several times during the season. This may make it necessary to shift a wagon box and a hay ladder, leave a home job incomplete, or otherwise change from one job to another several times, entailing a waste of labor and upsetting the farm schedule. The real difficulty comes, however, when two or more rigs are ready to thrash on adjoining farms and it is necessary to secure the thrashing crews with exchanged help.

Without cooperation, farmers are not in position to demand the services of a good custom rig at a definite time, and as a result much valuable time is lost through delay, and the grain must either be put in the barn or exposed to the weather for an undue length of time.

COOPERATIVE METHODS.

Most of the difficulties which usually cause communities to buy thrashing outfits can be eliminated when a man is selected to act as an agent for all the farmers of a given neighborhood. Such an agent can usually hire the services of a good thrashing rig and be in a better position than the individual farmer in demanding the best of service. In some instances that were reported, this was done, in others it was found to be impracticable, while in other cases the

farmers decided, without trying the collective hiring plan, that the purchase of an outfit was the only solution of their problems.

Thus there are two general methods of ring¹ cooperation. The more common method involves the hiring of the outfit, and the other its purchase. In either case a well-organized ring is essential, composed of a number of farmers working as a unit for the purpose of systematic cooperation in the busiest season of the year, when time is precious.

The possible advantages of ring cooperation are partially shown from some of the many replies from men with considerable experience. The following are typical:

“You can thrash when ready and get done earlier for fall work.”

“You know you will have your grain thrashed in good time. It draws neighbors closer together” (7 years' experience).

“Can thrash when ready” (6 years' experience).

“Can thrash sooner and always know whose turn comes next” (10 years' experience).

“We can thrash when we are ready and it does away with lots of help.”

SYSTEMATIC COOPERATION SAVES LABOR.

The advantages of systematic cooperation, as usually cited, whether the thrashing rig is owned or hired by the circle, may be summarized briefly as follows: (1) The thrashing order is so arranged that the least possible time is lost in moving from farm to farm. (2) As a job nears completion, the first men through, knowing their assignments and the next place, may go immediately and have the grain ready to thrash by the time the outfit arrives and is set. (3) No time is lost either in contracting an outfit or in securing a thrashing crew, for that is arranged for in advance. (4) Certain men may be utilized most efficiently by assigning them to one kind of work for the season. (5) Unless the weather prevents, the thrashing continues until all the jobs are completed in the circle; thus little extra work is required in

¹ In this article the word “ring” is used to designate the number of men or the farms required to supply the labor needed in running a thrashing outfit, regardless of its size.

shifting wagon boxes or hay loaders. (6) The labor of putting the crop in the barn can be dispensed with. (7) The thrashing season is greatly shortened. (8) The ordinary farm work is usually postponed until the thrashing is all done, and thus the farm labor schedule is not seriously interfered with. As a result, the oats stubble can be plowed considerably sooner, the seed bed for wheat can be more thoroughly prepared, there is more time to haul and scatter manure and to attend to early fall work, and thus the farmer has a better chance to keep ahead of his work.

SUCCESSFUL COOPERATION RELIEVES ANXIETY AND WORRY.

Membership in a thrashing ring serves to relieve the farmer of much anxiety and worry: (1) Each member is assured that a machine for doing his work has been arranged for. (2) The chances of losing his grain are reduced to a minimum and a smaller percentage is lost or damaged. (3) A member can calculate approximately his time to thrash, for he knows the order of thrashing and the acreage ahead of his, and the women can plan accordingly. (4) The plan usually guarantees him most of his necessary help. (5) The credit for labor differences may be properly adjusted. (6) The cooperative spirit may extend to other lines of work and its influence may be felt in a social way, as, for instance, the thrashing season in a number of rings ends with an annual picnic.

PROBLEMS INVOLVED IN RING OWNERSHIP AND MANAGEMENT.

The success of any cooperative movement depends largely upon the care with which plans for the organization are laid. The members must meet and discuss the business involved, and mutually agree upon the principal issues. Minor details can be decided easily from time to time. The ring as a whole acts just as a single individual. To be successful, each member must be willing to submit to the rule of the majority, and should know exactly what the plans are and what he is expected to do.

SIZE OF THE RING.

A circle should include at least as many farms as would be necessary to supply the hands needed to do a job of thrash-

ing most efficiently. That number will depend largely upon the capacity of the outfit. When the thrashing ring is one of the largest, and the farms have a very large grain acreage to thrash, the purpose of cooperation may be defeated, for the help can not be handled to the best advantage, the last jobs are too long postponed, and too much time is lost in exchanging help at a distance. In case the machine is idle, because of a breakdown or bad weather, too much time is lost with a large thrashing ring. Only a few of the very large rings have proved successful. In most cases circles with a combined acreage of 1,000 acres or more to thrash have found it advisable to reorganize in smaller units.

The variation in the size of the different thrashing rings can be best illustrated by the following classification, for which data are at hand from 70 rings:

Table showing relation of size of ring to acres of grain and size of separator and crew.

Size of ring.	Number of ring members.	Number of rings.	Total grain acres in ring.	Length of separator cylinder in inches.	Total number of hands.
Very large.....	15 to 20....	7	1,000 to 1,600..	36 or over....	30 to 40.
Large.....	12 to 15....	9	700 to 1,000....	32 to 35.....	25 to 30.
Medium.....	8 to 12....	28	400 to 700.....	28 to 31.....	12 to 20.
Small.....	3 to 6.....	26	160 to 300.....	Under 28....	6 to 9.

The above classification is only an arbitrary one, but it will illustrate the fact that thrashing rings do vary considerably in size, and that there are a number of important factors to consider when deciding the size of a thrashing unit.

Possibly the first step in ring organization is to decide which farms can best unite for thrashing work. The column headed "Number of ring members" shows the usual number of members or the cooperating farms belonging to the different-sized rings. The column headed "Total grain acres in ring" includes all the small grains to thrash. In some localities oats may make up the greater part of this area. The column headed "Length of separator cylinder in inches" shows the different-sized machines corresponding to the various amounts of grain to thrash, and the last column gives the total thrashing help generally used.

With the data given in this table, one should be in a better position to decide how to start a thrashing ring. For example, 7 neighbors are considering the purchase of a thrasher. Together, they have as a usual thing about 280 acres of small grains to thrash, and can furnish at least 10 men with their regular help. If one of them has a good farm tractor, then a small separator with a cylinder under 28 inches in length will handle their grain very satisfactorily. The number of farms and the total grain acreage is not sufficient to justify the purchase of a very large separator.

Another glance at the classification of thrashing rings shows that as a general thing a very large circle with 15 to 20 members, or that number of farms, has 1,000 or more acres of grain to thrash within the membership, which requires a large separator with a cylinder 36 inches or more in length, and needs 30 to 40 men to help to do a thrashing job.

Thus it will be seen that the size of a ring may be shown by the number of members, the amount of grain to thrash in the unit, the daily capacity or size of the separator, or the amount of help necessary to operate the rig. The size of a ring can be best governed by limiting the number of cooperating farms and by the selection of a separator to correspond.

Under the column headed "Number of rings" in the above classification of rings, it will be seen that out of the 70 rings, most of which bought outfits the last 3 years, only 7 belong to the very large, 9 to the large, 28 to the medium, and 26 to the small-sized rings. This shows that the present tendency is toward the smaller thrashing units.

Advantages of the smaller rings.—Many advantages are claimed for the medium and small rings. They may be summarized briefly as follows:

A small group of men can be managed more efficiently than a larger one, and the venture is less hazardous and more harmonious.

It is easier to find a capable manager. The ordinary farm business does not train farmers, as a rule, in the management of large numbers of men. Several rings which owned outfits run with 30 or more helpers failed for want of a manager capable of handling successfully so large a group of men.

With the small ring there is less loss of time when the rig is idle owing to a breakdown or to bad weather; the distance to go to return help is not so great; and the difficulties, in general, are considerably less.

The season's work is greatly shortened; the grain is not so liable to loss; the labor of putting the crops in the barn is saved; and the straw can be sheltered in better shape.

The investment in a large shed may be considerably reduced or dispensed with entirely.

The number of men to board is considerably less. All the men can sit at one table and the women's work is not so burdensome.

A small group of men can assemble more readily than a larger one, and fewer rules for governing the organization are necessary. In many of the small rings the members meet and mutually agree without any formal organization. This arrangement is possible when a small rig is owned by 4 or 5 farmers.¹

¹ As a further guide in the proper selection of the power to run a thrashing rig, the following information is inserted:

"On the basis of wheat yielding at the rate of 20 bushels per acre, and medium heavy straw, the maximum capacity of the different machines would be about as follows, and approximate power necessary to operate also as follows:

Approximate maximum capacity and power necessary to operate different sizes of separators.

Size of thrasher.	Bushels per hour.	Horsepower required.	Size of thrasher.	Bushels per hour.	Horsepower required.
18 by 36	60	6	32 by 54	150	16 to 18
22 by 40	75	8 to 10	36 by 60	175	18 to 20
24 by 42	100	10 to 12	40 by 66	200	20 to 25
28 by 48	125	10 to 16			

"There are records where much more has been thrashed in the time given, but for steady run, the above is a good average and aimed to be conservative." (National Gas Engine Association, Standards and General Engineering Data, Vol. I, page 5A.)

PROPERTY OWNED IN PARTNERSHIP.

The property owned in partnership varies for the different rings. The following list includes most of the machinery items that are ever owned in partnership, but usually not all of these are owned by any one ring: Engine (with water tank when steam is used); a separator and clover huller; corn sheller and ensilage cutter; hay baler; shed for housing the property.

The members must decide for themselves what property it is advisable to own in common. In several instances, the ring found it best to hire the services of an experienced man who furnished either the power or the thrashing machine, assumed the responsibility for the outfit, and paid half of the expenses for half of the receipts. All members paid the customary rates for thrashing.

Many of the Illinois rings did not buy clover hullers, as clover is not a very profitable seed crop there. In other cases, either a clover attachment for the separator or a clover huller was included in the outfit. Likewise, the practice of shelling corn is quite common in Illinois and Iowa, but uncommon in other States. The advisability of purchasing a corn sheller, a hay baler, or an ensilage cutter must be determined by the local conditions.

Several rings found it advisable to use large wagon covers made of heavy duck treated with a waterproofing solution. In some cases, these were bought in common, in others each member was required to furnish one. The tarpaulins are kept in boxes under the wagon rack. This makes it possible for the loading to continue as long in the evening as the thrashing, and the covered grain insures an early start the next morning. The coverings are helpful also in case of a shower.

Frequently each member is required to furnish 10 sacks in good repair for ring use; sometimes sacks are owned in common. As a usual thing it is more satisfactory for property of this kind to be owned and cared for by the different members, as the equipment required by the individual varies with the amount of grain he has to thrash.

THRASHING FOR NON-MEMBERS.

In response to the question, "Do you thrash for outsiders?" practically all rings answered, "Yes," but the acre-

age thus thrashed is rather limited. In most cases, outside work is done for accommodation or to enlarge the ring in order to secure all the necessary help. Rather than let a neighbor's crop spoil, the ring outfit may thrash for a few farms. Outside work is done at the customary rates.

USING THE RING PROPERTY FOR PRIVATE PURPOSES.

It sometimes happens that a member may desire to use some of the partnership property for personal use, for example, pulling hedge with the engine, or using the engine to bale hay or saw wood, when the baler and saw are private property. Questions of this kind arise occasionally, and the members usually agree on a fair price to charge for the use of the property in question. One ring charged \$5 a day for the use of the engine, with no oil or fuel furnished.

CAPITAL INVOLVED AND PLAN OF PURCHASE.

The amount of capital necessary to finance a ring depends upon the amount of equipment included in the outfit and the kind of machinery bought. When a ring buys all the machinery new—separator, power, huller, and possibly a corn sheller or a silage cutter—and builds a shed to house the same, the total capital required usually amounts to \$3,000 or \$4,000 under usual conditions. More capital is required at present, since the war prices of machinery are about 60 per cent higher than normal. In some cases reported the amount was less, as second-hand outfits were obtained at a very reasonable price.

When it is possible for the company to hire a good engine or some other part of the equipment it may not be advisable to buy. In some cases, the engine or separator is hired from an outsider, and the common investment is thereby lessened. Where a tractor is a part of the farm equipment, it is often used to supply the power. Then the purchase of a small thrasher, especially made for the purpose, requires but a comparatively small outlay and the total investment is not excessive.

In reply to the question, "What was your plan of purchase?" most of the rings reported that each member assumed an equal share and the note given in payment for the

outfit is signed by each. Sometimes the tenant and the landlord jointly purchase a share. In this way, there is no difficulty in financing the enterprise. In a very few cases reported, shares of different sizes were issued and the members bought them in unequal amounts.

Each member is usually charged the customary rates for thrashing, and the gross receipts represent all the money collected for the services of the outfit. After the ordinary expenses are paid, labor hire, repairs, fuel, and oil, the net proceeds are applied as payments on the note or given as a dividend after the note is paid.

PLANNING THE WORK IN ADVANCE.

It is customary in some rings to discuss the work of the season at the regular meeting before the thrashing begins, and definitely plan for it. The aim is to learn how each member can best help. Some are assigned to work in the field or on the wagons, others to handle the thrashed grain. Each man remains at his job throughout the season or is responsible for it. If he desires a change, he must find someone to take his place. Thus each one knows where he is to work and no time is required in making assignments at the different jobs. The same wagon beds or racks remain in use all season, and need not be transferred for each move. Usually each member agrees to furnish a water boy at his own place.

In some cases the members agree to begin work at 7 a. m. when the weather permits, have dinner at 12, and quit at 6 p. m., unless the job can be completed within half an hour.

The general practice is to charge the customary rates for thrashing, regardless of ownership. Those inside have the advantage of getting their work done first and of sharing in the dividends earned.

COOKING FOR THE HELP.

The old custom of boarding the help at the place where the machine happens to be at meal time is not satisfactory, especially when the whole crew can not sit at one table. The problem of cooking is not only a serious matter for the women, but the cost is no small item of expense. As a re-

sult of a breakdown or a change in the weather, the thrashing plans may be changed and the expense and work of preparing meals greatly increased. Several rings have discussed the meal question, and some have adopted the plan of carrying their dinner pails and horse feed. In this case meals are served to the machine crew only, though hot coffee is served to all hands. A number of others follow the plan of serving only the noon meal, all going home for supper. Any plan which will reduce to a minimum the expense, labor, and worry of thrashing should be worthy of consideration.

ARRANGING FOR THE THRASHING HELP AND SETTLING THE
DIFFERENCE IN THE LABOR FURNISHED.

The amount of help to be supplied by the different members is determined in various ways. Each one is usually expected to furnish help in proportion to the amount of thrashing he has to do. The number of men is sometimes based on a given grain acreage, for example, a man to 20, 30, or 40 acres. It is rather difficult to form a good working ring and have each member furnish precisely his proportionate share of help. It is more satisfactory to require each man to furnish a definite amount of help at each job, and then adapt some plan of settling the difference in the amount of labor furnished. In some rings the members are left to adjust that between themselves, each member endeavoring to furnish as much help as he receives, but this method is seldom entirely satisfactory.

The plan followed in a number of other cases calls for a timekeeper to keep a record and make a settlement for the members. Of several methods of doing this perhaps the easiest and most practical is as follows:

Each member is expected to furnish a given number of men and teams for each job in the ring, which may be based on his acreage to thrash. A day's work for a man shall be regarded as 2,000 bushels of oats and its equivalent in wheat or rye. (For practical purposes, to determine this equivalent, divide the oats yields by 2, for most outfits thrash oats about twice as rapidly as wheat or rye.) This plan of determining a day's work does not compel the timekeeper to keep tab of the hours of labor actually worked by the dif-

ferent members. He must keep or secure a record of the total grain thrashed for the different members, and record the number of helpers furnished on each job. In case of a breakdown, the loss of time is equally distributed, for the labor credit is based on the actual grain thrashed. The following model form shows the summary of a complete settlement of a season's work in one ring:

Summary of complete settlement of a season's work in one ring.

	Ring members.								Totals.
	King.	Ott.	Gray.	Kell.	Rowe.	Todd.	Eby.	Hill.	
Bushels of oats.....	1,800	750	1,150	620	1,360	1,800	1,200	1,000	9,680
Rye or wheat.....	600	420	560	460	510	640	700	600	4,490
Regular men furnished..	2	1	2	1	2	2	1	1	12
Total credit (days).....	18.6	9.3	18.6	9.3	18.6	18.6	9.3	9.3	111.6
Credit ^a	\$55.80	\$27.90	\$55.80	\$27.90	\$55.80	\$55.80	\$27.90	\$27.90	\$334.80
Debit ^b	54.00	28.62	40.86	27.72	42.84	55.44	46.80	39.60	335.80
Balance.....	+1.80	-.72	+14.94	+.18	+12.96	+36.00	-18.90	-11.70

^a For labor at \$3 per day.

^b For grain thrashed at 1.8 cents per bushel (for labor only).

It will be seen that the amount of grain thrashed for each member is placed directly under his name. For example, Mr. King had 1,800 bushels of oats and 600 bushels of wheat. The third line shows the regular men furnished at each job. Mr. King and three others who had large acreages of grain each furnished two men and the others one each. In the column headed "totals," the total amount of oats thrashed for all the members is 9,680 bushels and of wheat or rye 4,490 bushels, equivalent to 8,980 bushels of oats, or a grand total equal to 18,660 bushels of oats. Dividing this total by 2,000, the number of bushels considered as a day's work for a man, we have 9.3 days, which represents the time to do all the thrashing in the circle. Now since Mr. King and three other men furnished two men at each job, each should get a labor credit of 2 times 9.3 days, or 18.6 days, and the other members should get 1 time 9.3 days, or 9.3 days' credit each. This total credit in days is given in the fourth line.

The next line gives the credit in money for the time each one spent. While \$3 per day was the value of the harvest help last year, in normal times it is considerably less. Its value must be governed by the current wages, so that each member will be willing to supply his share of helpers. Thus, Mr. King got credit for \$55.80 ($\3×18.6), and the others accordingly. The total credit for all the labor is \$334.80. The timekeeper then charges each member according to the grain he has had thrashed. This is determined by dividing the labor credit (\$334.80) by the grand total of bushels of oats thrashed and its equivalent in wheat or rye. Thus each member is charged 1.8 cents per bushel ($\$334.80 \div 18,660$). From this is figured each member's debit for labor on grain thrashed. Thus Mr. King, having 1,800 bushels of oats, plus the equivalent of 1,200 bushels more in wheat (600 bushels wheat $\times 2$), would owe the ring \$54 for labor. But his credit for labor as given directly above in the same column is \$55.80. Thus he has no actual outlay in money; on the contrary there is due him \$1.80 for surplus labor. A glance at the various amounts in the same line will show how nearly each one supplied his share of work. Messrs. Ott, Eby, and Hill are in debt to the ring as shown by the minus signs, and after the timekeeper collects from them he can pay Messrs. King, Gray, Kell, Rowe, and Todd, who furnished more than their share of labor. The credit will equal the debit if the per-bushel charge is the result of an exact division. In this example the settlement shows a final balance of 98 cents ($\$31.22 - \30.24).

This plan necessitates the handling of a very small amount of money, in fact, only the amount which represents the balance of the labor furnished. The money handled in this way by the timekeeper must not be considered in connection with that handled by the treasurer.

Each ring must determine for itself the amount of grain to consider as a day's work and a fair value for the labor. To settle differences in the amount of horse labor furnished, a team may be given the same or half the credit as that of a man and be included in the record in the fifth line of the above model form.

MANAGEMENT OF THE MACHINERY.

In response to the question, "Do you hire an outsider to take charge of the outfit?" the replies show that the general practice is for the manager or captain to hire all the necessary help to operate the thrashing rig, to keep their time, and issue an order for their pay. When this is done, if the services of the men are not satisfactory, they can be dismissed without trouble in the circle. In several instances, however, the engine and separator are operated by members of the ring at a given wage, and each assumes the responsibility of his machinery. In other instances the manager operates the engine and hires outsiders for the other regular work. Whenever members are detailed with the outfits they are paid fixed wages and are expected to take better care of the property than would someone with no financial interest in it.

ARRANGING THE ORDER OF THRASHING.

The replies to the question as to how the thrashing order and route is determined may be summarized as follows:

"Alternate ends of run yearly."

"Quitting place, beginning place next year."

"Last in wheat run, first in oats."

"Skip four jobs each year."

"From 1 to 10—10 to 1 in the circle."

"Whoever is ready first."

The local conditions must be studied before the thrashing order and route can be best arranged. The first three methods above cited are the most common. It is not a difficult matter to make a good route when the farms are located on a road which incloses a section of land. Unless there is a considerable variation in the time when a certain grain crop can be thrashed, due to variety differences or soil conditions, the order should be definitely arranged beforehand so as to avoid trouble and enable the members to plan accordingly.

RING REGULATIONS.

Whether a ring owns its outfit or not, there is need of a written agreement among its members. For practical purposes, it should be brief. The main features in the agreements of cooperation are usually something as follows:

SECTION 1. That the name of this ring shall be _____.

SEC. 2. That the officers shall be president, secretary-treasurer, manager, and timekeeper, elected for one year.

SEC. 3. Duties of officers:

a. It shall be the duty of the president to call meetings and to preside at the same; to act as chairman of a committee to settle disputes which may arise between members, the other two committee members to be selected by the disputing parties.

b. It shall be the duty of the secretary-treasurer to keep a record of the business transacted at the regularly-called meetings in a book provided for the purpose; to keep an account of the number of bushels of grain thrashed on each job and to submit a statement of the thrashing bills at the second regular business meeting; to keep account of all money received and paid out and to keep receipts or bills for the same.

c. It shall be the duty of the timekeeper to keep a record on each job of the men and teams furnished by each member; to get from the secretary-treasurer at the end of the season figures on the total number of bushels of grain thrashed and to submit at the second regular meeting a statement showing the amount of credit each member may have for extra work or the amount he may owe when he has not supplied his share of help. [This is based on the prices given in section 6 and may be calculated according to the method described on pages 257 to 259.]

d. It shall be the duty of the manager or captain, when the rental plan is followed, to secure the services of the thrashing rig designated by the ring and to arrange definitely the time when it must begin work, or, if the outfit is owned by the ring, to be responsible for its management; to hire the men to operate the machinery in case they are secured outside the circle, to direct the work in all details—looking after the necessary supplies of fuel, oil, and repairs—to change men to different jobs if found necessary; to keep an account of the sacks, the canvas, or any property of this kind and to return the same to owners for repairs. He shall treat all members in a courteous manner and endeavor to avoid quarrels and disputes by just decisions and fair treatment.

SEC. 4. The owner of the grain shall be the sole judge as to the condition of his grain for thrashing.

SEC. 5. The per-bushel charge for thrashing grains shall be as follows, regardless of membership, unless otherwise changed: Oats, _____; barley, _____; wheat, _____; rye, _____, and clover, _____.

SEC. 6. That each member shall be given credit for man or team labor furnished at the rate of \$_____ per day each. That a day's work shall be based upon 2,000 bushels of oats or its equivalent in wheat or rye. Settlement for labor differences shall be made on this basis unless otherwise changed by the members.

SEC. 7. Wheat and rye shall be thrashed on the first round of the machine and oats on the second. Any member, if he prefers, may

wait and thrash all of his grain at the same time. The second round shall follow the first in reverse order unless otherwise changed. If a member for any reason loses his turn in either round, his turn shall come last, unless the members otherwise arrange.

SEC. 8. The thrashing order for wheat shall be as follows: -----
-----, and the reverse for oats.

SEC. 9. Three-fourths of the members shall constitute a quorum to do business, New members shall be elected by a majority vote of the total membership.

SEC. 10. Each member by signing the cooperative agreement of the ring thereby agrees to abide by the rules and regulations and will endeavor to work for the best interests of the club, and respond to a call for help from members in preference to outsiders. The penalty for violation of regulations may be the refusal of the other members to furnish help to the one in question. This action must be based upon the majority decision of the committee.

SEC. 11. Two regular meetings shall be held yearly, at -----, one the first Tuesday night in July and the other the third Tuesday night in September. The business of the first meeting shall be mainly that of formulating plans for the season's work. At this meeting the ring should (1) vote on the admission of new members, (2) arrange for the transfer of shares in case a member moves away, (3) make the necessary change in the thrashing order, and (4) make any desired change in the thrashing rates or the prices which govern the value of labor differences. The business of the second regular meeting shall be mainly the settlement of accounts and the election of officers for another year. The order of business should include: (1) The report of the secretary-treasurer, which may give a summary of all the grain thrashed and the total expenses and submit the accounts of the different members who are expected to pay cash or give a note for the same; (2) the submission of unpaid bills for payment; (3) the timekeeper's report on the total amount of labor furnished by each member and the account of each [a settlement for the labor difference is expected at this time or as soon as the work is all completed]; (4) miscellaneous business; (5) election of officers for the following year; (6) amendment of the regulations.

The above regulations embody most of the essential points covered in the different sets of agreements studied, and they are submitted mainly as a guide in getting a ring started. The duties of the various officers may be assigned as the members see fit. Likewise any of the provisions not applicable to a given organization may be modified or eliminated as the conditions may warrant.

RING OWNERSHIP AND MANAGEMENT OF THE THRASHING OUTFIT VS. RING HIRING.

Ring ownership necessitates more or less partnership capital with a financial risk, while the hiring plan requires no

investment whatever. Either form of organization demands a spirit of cooperation—the united action of several men engaged in the same business—which is the keynote of success in modern business. Any movement which encourages this tendency of cooperation among farmers is well worth while.

The ring-hiring plan of solving the thrashing difficulties is a very satisfactory method, providing a good outfit can be hired at the proper time, and providing it does not require the cooperation of too large a group of men. With the proper conditions, the ring can then secure most of the benefits of cooperation without any investment whatever, and the dissatisfaction which may arise from a common investment in property is eliminated.

RING OWNERSHIP OFTEN A NECESSARY MOVE.

The fact that ring ownership does involve difficulties which have caused several failures does not seem to hinder the spread of the movement at present. In many instances there seemed to be no other alternative, and during several years of experience many of the old difficulties of ownership have been overcome. The necessity for ring ownership in certain cases is evident from the following replies submitted in answer to the question, "Why did your members find it advisable to buy an outfit?"

"Unable to get an outside machine that was satisfactory."

"Hard to get a good rig and had to wait."

"Had to wait two or three weeks and then get a worn-out rig."

"Labor shortage to run a large outfit."

"To save the grain and thrash when it is fit."

In a number of instances, the farmers experienced the partial loss of a crop or had been seriously delayed in getting the thrashing done. Usually, it is not the high price of thrashing nor the desire to make it a money-making scheme that prompts the farmers to buy outfits, but a desire to own their rigs so they can thrash the grain when it is ready, save the larger percentage of it, put the straw under shelter in much better condition, and get the season's work finished sooner. This leaves more time for the regular farm work. If the thrashing can not be done cheaper, the difference is more than offset by the many advantages, and for this reason the farmers readily decide to make the venture.

USUAL OBJECTIONS TO RING OWNERSHIP.

No move which involves cooperation, even though no capital is involved, can be uniformly successful, for groups of men vary in their ability to hang together. The following replies received in answer to the question, "What is the worst objection to ring ownership?" show lack of complete harmony:

"Discord among members."

"Every member wants to thrash first."

"Letting the other fellow shoulder the responsibility and then finding fault with him."

"Too many members who are either kickers or slackers."

The 53 answers may be summarized as follows:

Lack of competent help, too large a ring.....	4
Dissatisfaction due to various causes.....	9
No objection with good management.....	2
No objection.....	38

The fact that 38 out of 53, or 75 per cent of the replies, indicated no objection to the ownership of rigs, is largely due to the more recent tendency to organize in smaller groups and thus avoid the main objections to the movement.

The one main cause of dissatisfaction has been too large a membership. This is shown in the following statement by the vice president of a large concern that manufactures thrashing machines:

"Where there is a large association of members, dissatisfaction of one nature or another usually arises, resulting in the splitting up of the association and the placing of the rig in the possession of good operators that are capable of doing custom work."

SUCCESS OF RING OWNERSHIP OF THRASHING RIGS.

It is impossible to determine what percentage of the ring purchases of thrashing rigs prove to be successful. The opinions of men vary. This is a recent statement of an official of another large thrashing machine concern:

"There are a good number of farm thrashing companies throughout the State of Indiana, and it is our opinion that 90 per cent of these companies operate successfully and satisfactorily. Occasionally you will find them where there is disagreement and the organization breaks up, the ring dis-

bands, and the thrashing is done by some custom operator. However, on the whole, we believe that it is a successful proposition."

The economical and financial possibilities of ring ownership are indicated by the experience of the following rings, which also represent three of the smaller-sized thrashing units.

1. *Example of a large ring.*—Up-to-Date Thrashing Co., Livingston County, Ill.; organized in 1914; 10 members, shares owned in unequal amounts; 15 farms in ring; partnership capital, \$3,275; equipment includes a 20-horsepower steam engine, a water tank, a separator with 34-inch cylinder, a corn sheller, and a second-hand silage cutter.

The practice thus far has been for the manager to hire outside help to run the engine and separator. The summary of the work during the first four years is as follows:

Summary of 4 years' work of a large ring.

Year.	Thrashing oats.	Shelling corn.	Cutting silage.	Gross receipts.
	<i>Bushels.</i>	<i>Bushels.</i>	<i>Tons.</i>	<i>Dollars.</i>
1914.....	46,339	10,128	515	1,207
1915.....	73,699	14,217	502	1,767
1916.....	43,301	26,643	496	1,245
1917.....	73,234	None.	940	1,756

The customary prices are charged for all the thrashing done. At the end of the fourth year the treasurer reported \$282 on hand. Out of the money ordinarily paid for custom work the outfit had met all expenses and paid for itself, and it was considered good for at least 6 or 7 years more service.

The total thrashing force usually employed in this ring for field work is as follows:

Ten men with teams to haul bundles; 5 pitchers in the field; 3 men with teams to haul the thrashed grain; 2 men to help unload grain at the barn; 1 man on the stack; 1 man to operate the stacker; 1 man to clean up about the machine; 1 water boy; 3 men with the outfit.

This represents a force of 27 men. A ring of this size demands good, capable management to insure success, and this company has been very successful and the members are well pleased with the results.

2. *Example of a medium-sized ring.*—Brush Ridge Thrasher Co., Marion County, Ohio; organized in 1905, 5 tenants, 8 landowners; original partnership capital, \$2,700; members signed notes in payment and let outfit pay for itself; equipment included a 32-inch separator, a clover huller, a 20-horsepower engine and a shed to house the outfit.

The work done the past two seasons is as follows:

Summary of 2 years' work of a medium-sized ring.

Year.	Oats.	Wheat.	Barley.	Clover.
	<i>Bushels.</i>	<i>Bushels.</i>	<i>Bushels.</i>	<i>Bushels.</i>
1917.....	26,200	4,030	400	61
1918.....	27,163	5,224	568	40

A limited acreage of grain is thrashed for outsiders. The total acreage of grain thrashed averages about 650 acres.

The success of the outfit is indicated in the following statement by S. R. Reber, one of the officers of the ring:

“We bought our first outfit in 1905 and paid for that and bought another in 1913. We paid up the last note this last November, 1918, with a balance of \$13.67 in the treasury.”

This is a good example of the medium-sized rings. The help needed to run the outfit is not so large but that it can be managed successfully without great difficulty, and the acreage is large enough to make it a financial success.

3. *Examples of the small ring.*—Organized in 1918, Fayette County, Ohio; members, 3 landowners; partnership capital, \$1,000; this represents only the cost of a small 22-inch separator which has a clover-seed attachment; the power furnished is the 12-24 farm tractor used on the farms; grain acreage in the circle, about 400 acres; thrash for a few outsiders only.

The work done during the season of 1918 is as follows: 2,800 bushels of oats, 9,000 bushels of wheat, 100 bushels of clover seed.

The thrashing crew was as follows:

Five men with teams and wagons to haul bundles; no field pitchers, used bundle wagons; 2 men with 125-bushel wagon beds to haul grain 3 miles away; 1 man and a boy to manage outfit and to help some with grain.

Thus a total crew of eight men and a boy, with seven teams, successfully thrashed with this small outfit and de-

livered each day about 750 bushels of wheat to the elevator, 3 miles away. The use of a bundle wagon is not a very common practice in the Corn Belt, but this ring and several others in which it has been tried find it saves two or three helpers. The use of a gas engine also dispenses with the water boy, and the engineer has time to help considerably about the separator.

Mr. Edwin E. Sedwick, Alexis, Ill., and two others, with a total grain acreage of 180 acres to thrash, each have a 10-20 farm tractor, and last year they secured a 20-inch cylinder separator. Mr. Sedwick writes as follows concerning its success:

“Five of us, with my 14-year-old daughter to scoop back the grain, did all of our thrashing from the field in good shape in 11 days’ time. Each man pitched his own load. We think this plan far ahead of the old idea of exchanging help. We get our straw in the barn in good shape, which is a great saving. As we had a big job, we paid for one-fourth of our separator this year with the money ordinarily paid out for custom thrashing; I think there will be more outfits of this kind sold next year.”

Pasko, Armstrong, Sahr Co., Huntington County, Ind.; organized September, 1917; partnership capital includes a 20-inch cylinder separator, which cost \$900, a clover huller, corn husker, a hay baler, and a machine shed 27 by 34 feet; acreage of grain to thrash, 400 acres; thrash for no outsiders; the custom thrashing prices are charged.

The thrashing work done during the 1918 season was as follows: 14,000 bushels of oats, 1,400 bushels of wheat, and the net receipts were \$180.

The president of this company, Mr. Armstrong, also sent this statement concerning the success of the company:

“Using the farm tractor for thrashing helps to pay for it, and we can thrash when the grain is ready. There should be no more than 6 members in a ring, for 6 men can operate a small machine and more are apt to cause trouble.”

The officers in this company consist of a president, secretary, treasurer, and machinist, who also acts as timekeeper.

FINANCIAL RETURNS.

Out of the 70 replies from rings to the question, “Will the outfit pay for itself?” 52 said, “yes,” 16 said it would in 3

to 5 years, and the rest said "if not in cash, it will in saving the crop."

It is evident from these reports that a rig, when well managed, under favorable conditions, can pay for itself within 5 years, after which the cost of thrashing is very trivial. The life of an outfit depends upon its care and the extent of its use, but judging from the experience of several, it will give good service for from 10 to 15 years.

In several cases, 20 per cent to 25 per cent dividends were declared. When it is possible to find a manager who can handle a large outfit successfully, and thrash at least 800 acres of grain in the circle, the financial return can be much greater than that for a smaller outfit, no matter how successfully run. The difficulty lies in the trouble to find competent managers who will work for the best interests of a large group of men.

PRESENT TENDENCY OF THE MOVEMENT TOWARD RING OWNERSHIP.

During the past two or three years, the number of outfits sold to farm organizations has greatly increased, and the tendency at present is toward the formation of smaller co-operating units and the purchase of smaller outfits. This is largely due to two reasons, (1) the necessity for the more economical use of labor, and (2) advent of the farm tractor. This power can be well utilized to run a small thrasher, which, complete with a wind stacker, a self-feeder, and a weigher, costs about \$1,200. The present tendency of the movement is indicated by the following statement of a representative connected with one of the leading thrashing machine companies:

"Most of the farmer clubs consist of only just enough farmers to make one good ring, so that they can get all their thrashing done in about 15 days. All the thrashing is completed in seasonable time, so that all the grain may be saved to the best advantage. We believe that for 1919 the farmer club business will be increased considerably, especially a lot of the smaller-sized separators will be sold to 2, 3, or 4 farmers, or just enough so that they can be ready to operate and not have more than is necessary to make the full outfit so that they can do their thrashing in a short time, then immediately get busy with the rest of their farm work."

THE REDISCOVERY OF AN OLD DISH.

By HERBERT P. DAVIS,

Dairy Division, Bureau of Animal Industry.

A VALUABLE FOOD WHICH LACKED RECOGNITION.

MANY an old-time cherished dish has gradually disappeared from its accustomed place on the American table. Sometimes its very existence has been almost forgotten. Such was the case with that stand-by of our grandmothers, "Dutch" or cottage cheese. Nearly all those of the older generation will remember having seen their mothers make this delicious cheese. It was good and they liked it, but for some reason it has largely disappeared. Cottage cheese has been made in a small way, it is true, but its appearance in the meal of the average family has been all too rare. One might have thought this cheese had been guilty of a crime, since it had apparently been dropped by polite society. There was more or less reason for the city family's not making cottage cheese. Seldom was there milk to spare, and when there was the small quantity was used in cooking. Cities with a large foreign population, however, did consume a considerable quantity of cottage cheese. Much of it was of inferior quality, but as it was almost always used for cooking, that fact did not hinder its sale.

The situation in the country districts was somewhat different. Nearly always there was plenty of skim milk for making cottage cheese, but for some reason it was believed that skim milk or "blue milk" was really of little value for human food. Every one knew that it was good for calves, pigs, and chickens, and that they made their best growth when it was abundant in the ration. The fact that skim milk can supply a rich and nourishing food for the family table was not recognized.

EXTENT OF SKIM-MILK WASTE.

It took a jolt to jar us from our lethargy. It required a great world war to make us realize the necessity of using

food wisely. During the war every effort was made to hunt out and eliminate waste and to make the best utilization of the food at hand. It was this search that revealed the immense food possibilities of that common dairy by-product, skim milk.

Of the 84 billion pounds of milk produced annually in the United States, 41 per cent is used for buttermaking. In securing cream to make butter, approximately five-sixths of the original milk remains as skim milk. In other words, about 29 billion pounds of skim milk is produced as a by-product. What has this skim milk been used for? Some of it has been condensed, much of it has been fed to live stock, some of it has been used in cooking, but a considerable portion has actually been wasted. "Blue milk," or skim milk, has all too frequently run down the sewers of creameries and milk plants, especially during the spring and summer. In one factory, only a year ago, 25,000 pounds of skim milk is said to have been wasted daily, and in another factory 10,000 pounds ran down the sewer every day.

To obtain the better utilization of skim milk for human food, the Department of Agriculture inaugurated a nationwide campaign. It was easy to see that much skim milk was available, but it was difficult to know how to get people to use it. There was a decided prejudice against milk from which the cream had been removed. How to convince people and make plain the great value of this product was a problem. Being a fluid, skim milk was thought to contain little or no nourishment. It therefore seemed desirable to devise ways of using skim milk in a more solid or concentrated form. Cottage cheese offered the opportunity. Easy to make, palatable, digestible, it could be eaten alone or in a great number of dishes. In fact, few people realized the diversity of its uses.

· CONSERVING FOOD BY MAKING COTTAGE CHEESE.

The food situation during the war demanded the sparing and careful use of meat; therefore, the food value of cottage cheese compared with meat was properly displayed. Calculations indicated wonderful possibilities. It was figured that if all the 29 billion pounds of skim milk were converted into cottage cheese, its food value would be practically

equivalent to our annual consumption of beef. So from an idea it grew to be a plan. People must be told that skim milk is valuable, that it can easily be made into cottage cheese of delicious flavor and high food value. But how to get the information to the city housewife and to the farmer's wife was the question.

A call was sent to the various State colleges: "Women trained in home economics are needed to demonstrate the making and use of cottage cheese in town and country." Forty women reported at Washington within a fortnight. A week or more was devoted to intensive drilling on improved ways of making cottage cheese and using it in various dishes. Then the force went into the field and intensive campaigns of a week or more were conducted in the large cities from coast to coast.

MANUFACTURE SHOWN BY MOTION PICTURES.

Demonstrations were given many times a day to all classes of people, in home-demonstration club rooms, in community kitchens, in stores, in settlement houses, schoolhouses, cafeterias, in fact any place that offered an opportunity for introducing the cottage-cheese propaganda to the people. In the demonstrations, cottage cheese was used alone, as a relish, in soups, in salads, in making meatlike dishes, and even in pie and custard. Meanwhile marketing specialists from the department cooperated with grocers, milk dealers, and others in order that cottage cheese of high quality might be available at reasonable prices. Dairy-manufacturing specialists visited creameries and milk plants where cottage cheese was being made or where there were possibilities for its manufacture. They advised, assisted, and instructed in the making of a first-class product. Moving-picture theaters showed notices of the meetings and pictures of the various ways of serving cottage cheese, and in many instances exhibited the department's two-reel feature film, "Why Eat Cottage Cheese?" In this film, the various steps in the manufacture, handling, and use of cottage cheese were graphically portrayed, and in that way instructed thousands of people who were not able to attend the demonstrations.

The demonstrators often were received with skepticism by the city housewife. She doubted whether cottage cheese

could be used in the variety of ways suggested, but if she attended the demonstrations and saw prepared and actually tasted the delicious dishes displayed, all doubt was quickly dispelled. "I never dreamed that cottage cheese could be used in so many ways," was a remark frequently overheard. Many a husband has been served with cottage-cheese soup, sausage, or salad. Like Cæsar, the women demonstrator came, saw, and conquered. The success of such an effort is hard to gauge. Exact figures are usually difficult to obtain. In one city, the quantity of cottage cheese sold daily jumped from 10 pounds to nearly 3,000, and in another from 350 pounds to more than a ton. The creamery which formerly poured 10,000 pounds of skim milk down the sewer every day later turned it into 700 pounds of cottage cheese. Restaurants, cafés, hotels, clubs, and dining cars added cottage cheese to their menus, and, what was more important than all, it was served in many homes. Cottage-cheese banquets and lunches, at which cottage cheese was used in practically every dish, came into vogue.

A COTTAGE-CHEESE MENU.

The following menu was served at the banquet of a prominent club of an eastern city:

First Course: ASTONISHMENT.

Cream of Cottage-Cheese Soup.
Croutons.

Second Course: INTEREST.

Cottage-Cheese Cutlet (No meat):
Creamed Potatoes. Mustard Pickles.
Graham Muffins. Whey Sirup.

Third Course: ADMIRATION.

Cottage-Cheese Salad.
Wafers.

Fourth Course: DEVOTION.

Cottage-Cheese Tart.
Mints.

The occasion was a great success. The food was good, in fact delicious, and even the critical went away thoroughly delighted. In some places, the enthusiasm reached such a

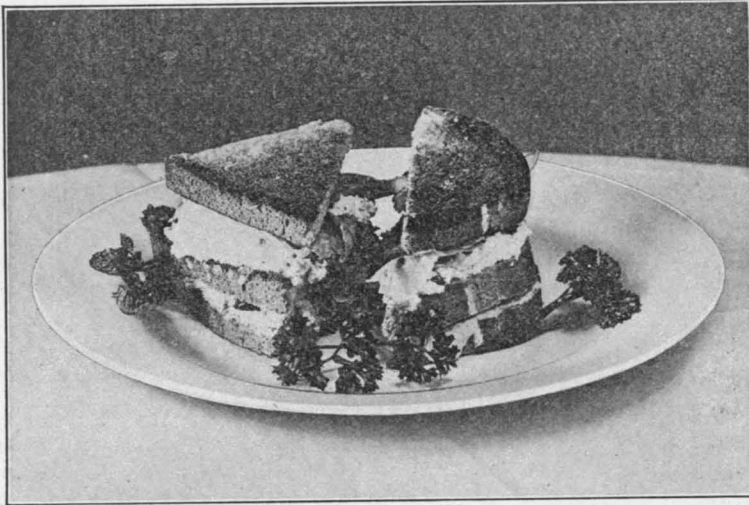

FIG. 1.—COTTAGE-CHEESE CLUB SANDWICH, PALATABLE AND NUTRITIOUS.

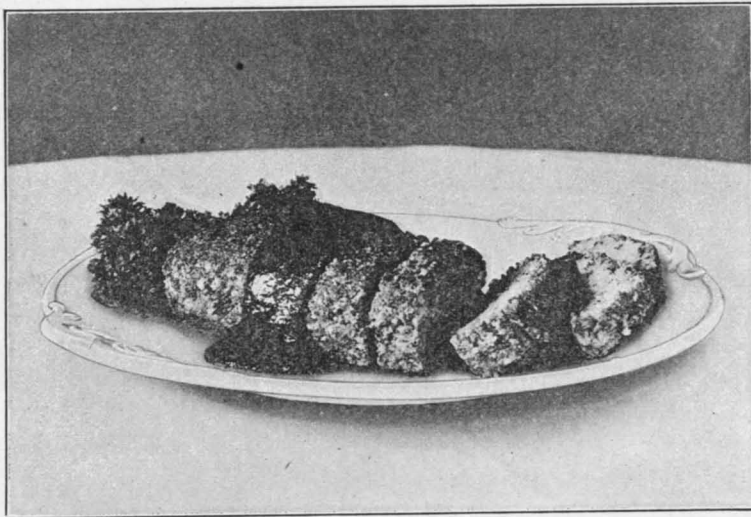

FIG. 2.—COTTAGE-CHEESE LOAF, A SUBSTANTIAL MEATLIKE DISH.

pitch that the common greeting was: "Good morning; have you eaten cottage cheese?" If we are to believe the indications, the success was very real.

THE FARM CAMPAIGN FOR COTTAGE CHEESE.

While not so spectacular, the farm campaign was no less successful. It was not carried on with the wave of enthusiasm that attended the city effort, but was a steady, constant, and, it is believed, effective effort to reach the people in the rural districts. A cottage-cheese worker was sent into nearly every State to train the State and county home demonstration workers, that they as well as she might be prepared to teach farm women the making and using of cottage cheese. The work was well organized. Whenever possible it was carried on through the farm bureaus with men and women county agents as leaders, but all agencies working for the betterment of country life were enlisted. There was no lack of skim milk. On most farms, indeed, in the North, there was an abundance which was being used for feeding live stock. To be sure, some was used for human food, but the quantity so utilized was pitifully small. In the South less was available, but as the people realized the human-food value of skim milk, the demand for cows increased.

So far as time and funds would permit, the States were covered systematically, county by county. Meetings were held at convenient times and places, in school-houses, Grange halls, churches, and in private homes. The women came doubting but were willing to be convinced. Too often the farm diet was without variety, meat and potatoes being the great stand-bys. In some localities, for months at a time, only salt meat was served. Seemingly the economy of using dairy products was not appreciated. That they were sold so completely that the farm family did not use them was indeed surprising, yet it was true. Gradually cream had disappeared from the farm table, followed in many instances by whole milk. Frequently skim milk was served, but who can like oatmeal with only a little skim milk? The result was that its use gradually declined. In other words, the people who were producing such a vital food did not use it. This was the situation that the demonstrators had to

face when talking cottage cheese. "Why, skim milk isn't worth anything," was a common remark. To produce delicious food from this little-valued product seemed amazing.

Remarks like "I never realized that you could make good things to eat from skim milk" were often heard.

ADDED FOOD VARIETY FOR FARM TABLE.

While skeptical at first, farm women were eager to learn. In a short time, from the farthest southeastern part of the country to the Northwest and from New England to the western coast, farm women were making cottage cheese and giving it to the family, not only alone, but in many attractive and tasty dishes. It furnished a much-needed variety for the farm table. Many took up the making of cottage cheese on a larger scale to sell to neighbors or to take to town. Selling cottage cheese was found to be profitable. One young girl, by making cottage cheese on Saturdays and selling it in town, was able to pay her way through a term at college. Girls' and boys' clubs in several States took up the work and found it one of their most interesting and profitable lines.

In at least one instance, cottage cheese saved a dairy herd from slaughter. A little 9-year-old girl, who attended a demonstration, learned to make cottage cheese, thus utilizing the skim milk from her father's herd. It turned the tables. An unprofitable herd became a profitable one, and dairy cows were saved at a time when none could be spared.

The ingenious ways of preparing cottage cheese often led to interesting incidents. At one place where supposed sausage was served, a prominent chemist refused to believe that it contained no meat. Only a practical demonstration of the preparation and cooking of the dish convinced him. A fireman who attended a cottage-cheese exhibit remarked: "These things are fine: Why did we have to wait till war time to have good things to eat?"

When properly and carefully made, cottage cheese rivals its more aristocratic sisters, Neufchâtel and cream cheese. Made by the process introduced by the women demonstrators, it became a new product, not the common dry, tough, grainy, sour-tasting cheese that tended to repel both

eye and taste, but a smooth, fine, rich, creamy product that appealed to all. Put up in a neat, attractive package it was readily sold.

SKIM MILK FOR HUMANS OR HOGS ?

Sometimes the question arose, "Is it better to turn skim milk into cottage cheese or feed it to the hogs?" for meat was vitally needed. This seemed a fair question, and the correct answer was sought. Investigation showed that when fed with corn or other grains, as is necessary, 100 pounds of skim milk would produce about 5 pounds of dressed pork. Compared with that, the same quantity made 15 pounds of cottage cheese. Now every one knows that cottage cheese is practically equal to most meats for furnishing that blood-and-muscle-building element, protein. With about three times this element of human food produced when made into cottage cheese, there seemed to be no argument left.

TO MAKE THE BENEFITS PERMANENT.

The main effort is over, and looking back, we try to find the real accomplishments. Certainly it is not too much to say that the American people, both in town and in country, have rediscovered an old dish. A food much used by former generations has been reestablished in society, but, more important than all, millions of pounds of skim milk have been converted into a palatable, digestible food.

It is too much to expect that cottage cheese will be used continuously in as large quantities as it was during the campaign. It is not too much, however, to look forward to a constant use of so valuable a food in thousands of homes where formerly it was not known. By no means the least accomplishment was incidental. The American housewife has been made to appreciate more fully the true value of dairy products. A food shortage developed the use of a valuable by-product the continued use of which will be a permanent benefit to the health and welfare of the American family.

The extent to which cottage cheese will be used in the future depends largely, of course, on its quality. Like many other dairy products, it is highly perishable, and should

have the same consideration as other foods requiring proper handling and, in warm weather, refrigeration. Even a knowledge of its high food value will not induce the public to use cottage cheese which is unpalatable. This fact suggests the advantage of marking the package with the name and address of the maker, in order that consumers may be able to make later purchases of cheese which has proved satisfactory.

PUBLICATIONS ON COTTAGE CHEESE.

The following publications of the Department of Agriculture on the manufacture and use of cottage cheese may be obtained on application to the Secretary of Agriculture:

Cottage-Cheese Dishes. Office of the Secretary, Circular 109.

How to Make Cottage Cheese on the Farm. Farmers' Bulletin 850.

Manufacture of Cottage Cheese in Creameries and Milk Plants. Department Bulletin 576.

Ways to Use Cottage Cheese. Bureau of Animal Industry Leaflet 18.

Cottage Cheese—An Inexpensive Meat Substitute. Bureau of Animal Industry Leaflet 24.

FOLLOWING THE PRODUCE MARKETS.

By G. B. FISKE,

Investigator in Marketing Fruits and Vegetables, Bureau of Markets.

TRAVELING by faith rather than by sight has sometimes been recommended as wise policy, but produce growers used to find it frequently and mightily disastrous when they followed it perforce, before the establishment of the Crop and Market Reporting Service of the United States Department of Agriculture. Of course, some of them are still following the faith system of growing and marketing because they have not seen fit to use the eyes furnished them by the Government reporting service, and these are still planting, gathering, and marketing at random. A constantly increasing number, however, are looking around and ahead, seeing what other sections are doing, finding where any shortage or surplus is likely to be produced, ascertaining special advantages or disadvantages in consuming centers, and generally getting a forecast of the market from crop and other conditions, the country over. Thus the more farsighted southern potato growers take into account the volume and probable movement of the northern crop and the amount of the old crop likely to be left over until spring. Even the northern growers may put in a late acreage and top-dress the crop if the general situation suggests a shortage caused by a reduced acreage or by a hard spring frost in parts of the northern territory.

IMPORTANCE OF CROP FORECASTS.

Texas onion growers use every means to ascertain the amount of old northern stock in storage and the rate at which it is going to market. The southern growers of cabbage, celery, and other special crops make similar calculations. Orange growers in Florida and California judge the outlook as affected by the probable supply of northern apples during the winter and spring seasons, and the northern

orchardists are interested in the citrus-crop prospects as affecting the demand for northern fruit.

Producers of hothouse crops also have a similar general problem. Said a well-known eastern lettuce grower some years ago before the Government crop and market reporting services had been developed: "I would give \$500 a year for quick news of the acreage and condition of southern lettuce." He could hold back his crop or advance its maturity considerably by a variation in greenhouse management. When news of a destructive freeze in the South reaches northern growers of hothouse products, if they are on the alert, seed beds and moisture are promptly regulated to take advantage of the shortage soon to occur, while near-by box dealers at once look up available supplies to meet the coming emergency. Unexpected weather conditions may enable a damaged crop to recover quickly or may destroy a promising outlook, but in the long run the comparatively few growers who study country-wide conditions are likely to come to good markets with large crops more often than the average growers.

EFFECT OF GROWERS' VIEWPOINT.

The majority of growers are likely to plant more or less unconsciously by the past rather than by probabilities. For this reason, a crop that paid well one season is likely to be overplanted the following year. Thus the short and high-priced potato and onion crops of 1916 were followed by very heavy planting in 1917 and also by liberal planting in 1918. The short bean crop of 1916 has been followed by a great increase of acreage in each of the two following years. The rule to plant lightly after a bad crop and heavily after a large one is not always safe, but it has proved safe oftener than the opposite course. Since official price statistics are now available for several years, the wise grower can plan his planting for the market in the light of a definite knowledge of the probabilities.

STEADYING INFLUENCES ON THE MARKET.

In marketing, this general principle of one extreme following another is frequently in evidence. Markets that are scantily supplied to-day may soon be glutted, but the ship-

per who acts promptly according to market reports of scarcity can often reach such markets early and receive the advantage of high prices. Handling shipments correctly in this respect requires all the judgment the shipper may possess even with the most prompt and reliable market news that he can secure. The recent development of a class of large distributors able to direct shipments successfully is doing much to equalize prices in the various markets of the country. The figures supplied by the railroads to the United States Department of Agriculture show that the greater part of some crops shipped long distances is shipped not direct to markets but to "gateways" and sent to final destination by diversions at these points, the diversions being made by order of the shipper in accordance with the condition of the various markets or with sales made while cars are rolling. By this system many markets are kept fully supplied by purchases of car lots soon to arrive, or within one or two days' run of those markets. This has a steadying effect on prices and usually tends to discourage consignment shipments to such points.

COMPETITION AND COOPERATION.

All shippers now have access to official market information which enables them to judge for themselves regarding the probable market conditions at the time when their shipments should arrive, and to act accordingly. With the less perishable crops like northern potatoes and apples, they may ship almost anywhere at any time, and may hasten or delay the movement if market conditions warrant such action. Thus during the past season, some of the southern potato growers, knowing the short crop forecast for Virginia and Maryland, and suspecting the beginning of a better market, held their potatoes a few weeks and were rewarded by advancing prices. For the same reason, some northern growers dug and marketed their potato crop a little earlier than usual. A short crop of anything in any leading producing section creates an opportunity for producers in a competing section.

On the other hand, greatly increased acreage and a favorable crop outlook in a prominent producing section may suggest the need either of haste or of delay in marketing

the product from some other sections the output of which normally comes to market at about the same time. In some seasons the supply is too great to be marketed satisfactorily, even without special competition from other sections, and it is such conditions that often force growers to unite for self-preservation. At these times they are in a frame of mind to cooperate in grading, packing, shipping, and advertising the product and to seek and develop new markets. Such efforts, begun as a last resort, have often vastly improved the position of growers, securing increased returns not only in the season of emergency, but also in the normal years that may follow.

OFFICIAL MARKET NEWS.

Growers often fail to obtain the full benefit of the official market information supplied by the United States Department of Agriculture in the form of daily market news bulletins, weekly market reviews, and monthly news articles. There are 32 permanent branch offices of the Bureau of Markets and numerous temporary stations in shipping areas which bring this news within reach of practically all shippers. (See figs. 13 and 14.) This market news is of two general classes: First, price information, and, second, conditions affecting prices, such as car-lot movements, diversions at specific points, supply both present and in sight, the demand, and the weather.

In studying market reports, it is soon noticed that the price itself is a "short range" indicator of conditions. Some markets may be relatively high and others lower than the rest. The following week the relative price situation may be reversed, owing to the arrival of new supplies in one set of markets and the clearance of stock held in the other markets. Sometimes such conditions may be forecasted by noting the reports from shipping sections naturally supplying these markets with certain products, and observing the dates of beginning shipments, in connection with prevailing conditions of rainfall and temperature.

MARKET DIFFERENCES AND PREFERENCES.

Some markets have a more or less permanent reputation for certain price features. A great market like New York may show extremes lower than other markets at times be-

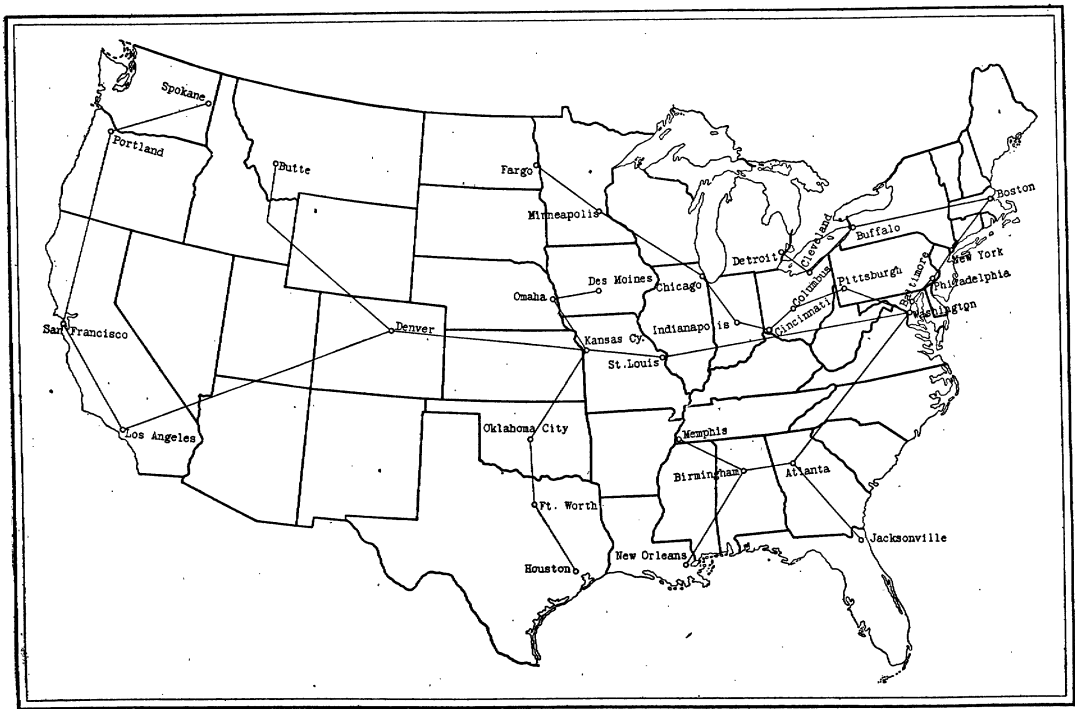

Fig. 13.—Extent of leased wire system and location of the 32 branch offices at market centers maintained by the market news service on fruits and vegetables during the 1918-19 shipping season.

cause it receives too much stock in poor condition, but often such a market may top other markets in prices paid for extra-fancy produce. Hence a large proportion of the earliest and choicest portion of a crop is likely to be shipped to such markets.

Well-known preferences exist in various markets, like that of the northeastern cities for red apples, or of certain southwestern cities for red onions. The price reports will suggest these preferences, which are more prominent in times of general oversupply. Small cities at times offer the best markets because they have been more or less overlooked in direct shipments of produce, but they are naturally subject to quick oversupply and then become the most unsatisfactory consignment points. Generally speaking, the smaller car-load markets are supplied by dealers who buy outright and do not solicit consignments.

INFLUENCE OF THE WEATHER.

Weather conditions affect the consuming markets in the large cities somewhat differently from the markets in producing sections, and the two sets of markets do not always move in agreement.

The consuming markets are affected considerably by weather, which sometimes stimulates the demand for certain products and sometimes demoralizes conditions by interfering with delivery or by injuring the quality of much of the stock.

In the producing sections, rainy or cold weather or extreme heat may interfere with gathering the crop, or may threaten its destruction, thus causing a temporary advance in price; or it may hasten the maturity unexpectedly and thus cause a sudden increase in supplies at the shipping stations. Under such conditions, prices may vary at shipping points independently of the consuming markets, that is, an advance or decline in price may be carried further in a shipping section than in the consuming market.

Although occasionally prices are relatively higher in the shipping section than in the distributing market, usually they are relatively lower, for the reason that the buyer at the shipping point takes considerable risk in purchasing for cash, and accordingly demands a considerable margin of

profit to cover his possible losses in shipping to a market which may decline while the shipment is on the way and where his sales may be adversely affected by the weather.

On the other hand, buyers at shipping points may be overconfident of an advancing market and pay higher prices than are subsequently realized in the distributing markets. Thus, last summer, prices f. o. b. Virginia shipping stations were at one time higher for potatoes than were quoted at any time in most large northern markets. Very hot or very cold weather may interfere with gathering and packing, may cause damage during storage and shipment, and during marketing and delivery upon arrival.

A NATIONAL VIEWPOINT NOW POSSIBLE.

A general study of the car-lot movement as reported in official market news bulletins and reviews, when considered in connection with crop estimates and weather reports issued by the United States Department of Agriculture, should enable the shipper to judge of the progress and length of the shipping seasons in the different sections. He soon learns to decide when a section probably has passed the peak of its shipping movement, and to note the rate at which a later section is coming forward. Often there is an intervening short time when certain markets will be scantily supplied and his own shipment will find a ready market. The time required for shipments to reach the distant wholesale market should be taken into account. Often the heavy or light car-lot movement of one week is reflected in the prices of the following week when the supply is being distributed at the distant market. A steady and rapid falling off in shipments from a certain section will suggest that by the time the shipper's stock can reach the market the movement in the competing section will be reduced still further.

The shipper should keep clearly in mind the main facts concerning his own and competing sections, the acreage, probable amount of shipments, and the time of beginning and end of the season. For some perishable lines, like strawberries, peaches, and melons, the shipping season for any one section may be very short, and a quick change in weather conditions may so affect the time and rate of shipments as

to cause violent fluctuations in the distributing markets. Shippers must be alert to take prompt advantage of such conditions.

SALES AT SHIPPING POINTS.

Besides considering all such points as those which have been suggested, the shipper has to plan how to handle his crop under his local conditions. In seasons of shortage and high price, his course may be comparatively plain. If he is in a large producing section, buyers usually will be on the spot offering cash on delivery at the station or warehouse. If in a smaller crop section, local buyers may be scarce and commission dealers will urge shipment or perhaps offer to buy the products f. o. b.—that is, paying the price agreed upon when a shipment is loaded on the cars or when it is delivered in the city to which it is consigned.

In times when the large markets are oversupplied, the local buyers, even in leading shipping sections, may be reluctant to take risks and the grower himself is obliged to assume the hazards of delay, damage, and unfavorable markets at the time of delivery, and perhaps also the risk of shipment to unknown dealers hundreds of miles away. These risks are reduced when shippers cooperate to the extent of making large and regular shipments of uniformly graded stock. They will then be likely to investigate their markets and dealers with due care, communicating with the consignee by wire when necessary, and perhaps they will have a broker or expert salesman to represent them in the distributing markets.

The distant small shipper, not located in a large shipping section, is at especial disadvantage in a time of heavy production. He can not profitably ship bulky products in less than car lots, on account of the cost of transportation. If his crop is not too bulky in proportion to its value, or if the price rules high, he may ship small lots by express. He may even to a limited extent find a market by parcel post, or he may sell by motor-truck service in neglected near-by markets.

CONSIGNMENTS AND OFFICIAL INSPECTION.

Growers who live near large markets or have a good local demand have comparatively few difficulties, but a vast num-

ber of producers throughout the country find it advisable to consign to commission dealers occasionally or all of the time. This plan has often provided a cash outlet for products that otherwise would have been lost. The old evils of unfair rejection of shipments, false grading, unjust claims of damage by reason of weather or otherwise—all such abuses may be reduced by the present system of official inspection. Services of Government inspectors of the Bureau of Markets in leading market centers are available to shippers at a charge of \$2.50 per car. The official inspection certificates are legal evidence with regard to quality and condition on arrival and are used as a basis for the settlement of disputes between the shipper and the receiver and in reference to loss and damage claims against the railroads.

MEANING OF THE MARKET TERMS.

In day-to-day quotations the actual changes may be slight, but the careful observer soon learns to form an opinion of the probable trend, especially for the less perishable products not subject to sharp, sudden changes because of the necessity of marketing the supply quickly regardless of demand.

The reader of the reports may notice, for instance, that potatoes generally are holding prices fairly from day to day and from week to week, with the advances more prompt than the declines and values gaining only a few cents when compared with the week or fortnight before. Under such conditions he considers the market "firm" and promising if there are only moderate car-lot supplies in sight. If the advances are fairly sharp and the declines slight and quickly overcome, he considers the market "strong" and notes the reports of the condition of the crop, the shipments, and the weather, to form a judgment of the length and extent of the anticipated market improvement.

On the other hand, the declines may be sharp and persistent, continually reaching low points and making slight and short recoveries, a condition which characterizes markets more or less "weak," according to the frequency and extent of such movements.

Occasionally prices may sag almost imperceptibly, simply falling a little short of the previous top quotations from time

to time, so that the decline is scarcely noticeable except by comparison with the level of the previous week or month. This is a "dragging" market, and may precede either a fur-

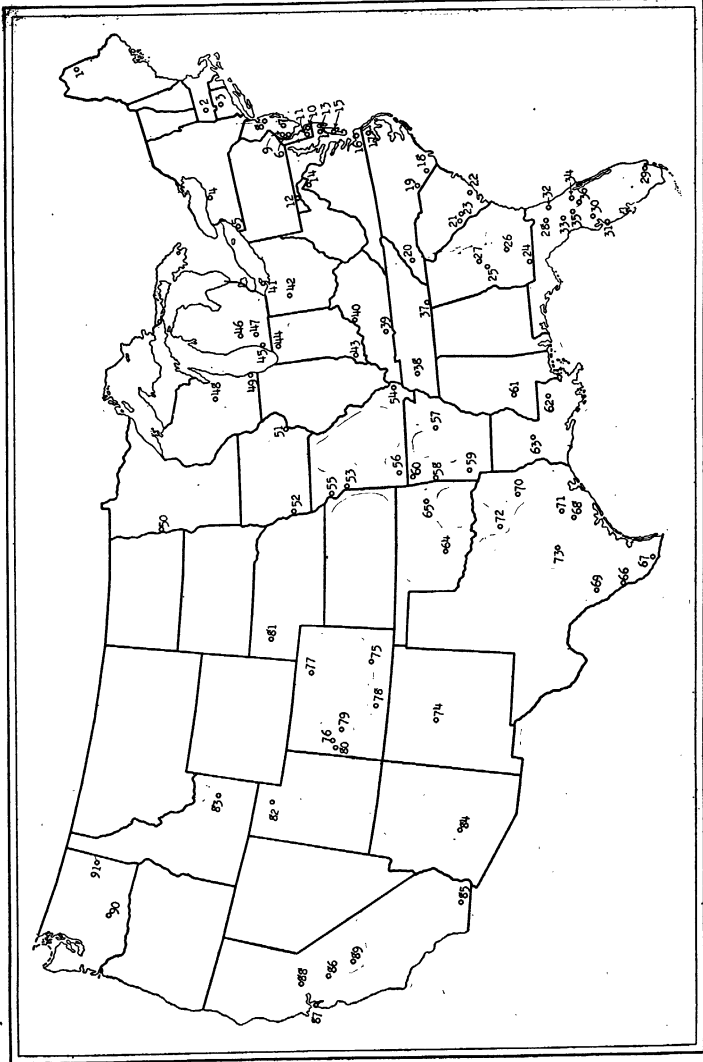

FIG. 14.—Location of the 91 temporary farmers' service offices at shipping points maintained by the market news service on fruits and vegetables during the 1918-19 shipping season. (See page 287 for names of offices and crops reported.)

ther decline or a change in the upward direction. Each man must form his own conclusions in the light of all the conditions affecting supply and demand.

Location of the 91 temporary farmers' service offices in producing sections shown in figure 14.

State.	Station.	Crops reported.
1. Maine.....	Presque Isle.....	Potatoes.
2. Massachusetts.....	Northampton.....	Onions.
3. Connecticut.....	Hartford.....	Peaches.
4. New York.....	Rochester.....	Apples, pears, onions, peaches, cabbage, celery, potatoes, dry beans.
5. New York.....	Westfield.....	Grapes.
6. New Jersey.....	Woodstown.....	Potatoes.
7. New Jersey.....	Hammonton.....	Peaches.
8. New Jersey.....	Freehold.....	Potatoes.
9. New Jersey.....	Swedesboro.....	Sweet potatoes.
10. Delaware.....	Selbyville.....	Strawberries.
11. Delaware.....	Seaford.....	Cantaloupes, watermelons.
12. Maryland.....	Cumberland.....	Peaches.
13. Maryland.....	Pocomoke City.....	Potatoes.
14. Virginia.....	Winchester.....	Apples.
15. Virginia.....	Onley.....	Potatoes and sweet potatoes.
16. Virginia.....	Norfolk.....	Strawberries, potatoes.
17. North Carolina.....	Elizabeth City.....	Potatoes and sweet potatoes.
18. North Carolina.....	Chadbourn.....	Strawberries.
19. North Carolina.....	Laurinburg.....	Cantaloupes, watermelons.
20. North Carolina.....	Waynesville.....	Apples, potatoes.
21. South Carolina.....	Williston.....	Asparagus.
22. South Carolina.....	Meggett.....	Potatoes, cabbage.
23. South Carolina.....	Blackville.....	Cantaloupes, watermelons.
24. Georgia.....	Thomasville.....	Watermelons.
25. Georgia.....	Fort Valley.....	Peaches, watermelons.
26. Georgia.....	Fitzgerald.....	Cantaloupes.
27. Georgia.....	Macon.....	Watermelons.
28. Florida.....	Starke.....	Strawberries.
29. Florida.....	Miami.....	Tomatoes, cabbage.
30. Florida.....	Plant City.....	Strawberries.
31. Florida.....	Palmetto.....	Tomatoes, strawberries, lettuce, celery, cabbage, mixed vegetables.
32. Florida.....	Hastings.....	Potatoes.
33. Florida.....	Ocala.....	Watermelons.
34. Florida.....	Sanford.....	Lettuce, celery.
35. Florida.....	Leesburg.....	Cabbage.
36. Florida.....	Orlando.....	Oranges, grapefruit, lettuce, mixed vege- tables.
37. Tennessee.....	Chattanooga.....	Strawberries.
38. Tennessee.....	Humboldt.....	Strawberries, tomatoes.
39. Kentucky.....	Bowling Green.....	Strawberries.
40. Kentucky.....	Louisville.....	Onions, potatoes.
41. Ohio.....	Port Clinton.....	Peaches.
42. Ohio.....	McGuffey.....	Onions.
43. Indiana.....	Princeton.....	Cantaloupes.
44. Indiana.....	Walkerton.....	Onions.
45. Michigan.....	Benton Harbor.....	Apples, pears, cantaloupes, grapes, peaches, potatoes.

Location of the 91 temporary farmers' service offices in producing sections shown in figure 14—Continued.

State.	Station.	Crops reported.
46. Michigan.....	Grand Rapids.....	Potatoes, dry beans.
47. Michigan.....	Kalamazoo.....	Celery.
48. Wisconsin.....	Waupaca.....	Potatoes.
49. Wisconsin.....	Racine.....	Cabbage.
50. Minnesota.....	Moorhead.....	Potatoes.
51. Iowa.....	Muscatine.....	Cabbage.
52. Iowa.....	Council Bluffs.....	Grapes.
53. Missouri.....	Kansas City.....	Potatoes.
54. Missouri.....	Charleston.....	Watermelons.
55. Missouri.....	St. Joseph.....	Apples.
56. Missouri.....	Monett.....	Strawberries.
57. Arkansas.....	Judsonia.....	Strawberries.
58. Arkansas.....	Fort Smith.....	Potatoes.
59. Arkansas.....	Nashville.....	Peaches, cantaloupes, watermelons.
60. Arkansas.....	Rogers.....	Apples.
61. Mississippi.....	Crystal Springs.....	Tomatoes, cabbage.
62. Louisiana.....	Hammond.....	Strawberries.
63. Louisiana.....	Alexandria.....	Potatoes.
64. Oklahoma.....	Chickasha.....	Watermelons.
65. Oklahoma.....	Muskogee.....	Potatoes.
66. Texas.....	Laredo.....	Onions, cabbage, lettuce, spinach.
67. Texas.....	Mission.....	Onions, cabbage.
68. Texas.....	Eagle Lake.....	Potatoes.
69. Texas.....	Crystal City.....	Onions.
70. Texas.....	Jacksonville.....	Tomatoes.
71. Texas.....	Hempstead.....	Watermelons.
72. Texas.....	Dallas.....	Peaches, onions.
73. Texas.....	Austin.....	Spinach.
74. New Mexico.....	Albuquerque.....	Potatoes, dry beans.
75. Colorado.....	Rocky Ford.....	Cantaloupes.
76. Colorado.....	Palisade.....	Peaches.
77. Colorado.....	Greeley.....	Potatoes, cabbage, dry beans.
78. Colorado.....	Monte Vista.....	Potatoes.
79. Colorado.....	Paonia.....	Peaches.
80. Colorado.....	Grand Junction.....	Apples, peaches.
81. Nebraska.....	Alliance.....	Potatoes.
82. Utah.....	Ogden.....	Peaches.
83. Idaho.....	Idaho Falls.....	Potatoes.
84. Arizona.....	Phoenix.....	Cantaloupes.
85. California.....	Brawley.....	Cantaloupes.
86. California.....	Turlock.....	Cantaloupes.
87. California.....	San Francisco.....	Dry beans.
88. California.....	Sacramento.....	Peaches, pears, plums, grapes.
89. California.....	Fresno.....	Grapes.
90. Washington.....	Yakima.....	Peaches, pears, prunes, potatoes.
91. Washington.....	Spokane.....	Apples.

LIVE STOCK AND RECONSTRUCTION.

By GEORGE M. ROMMEL,

Chief, Animal Husbandry Division, Bureau of Animal Industry.

SITUATION CREATED BY THE WAR.

THE Great War's effect on live-stock production has been profound the world over. Excepting only wool in Australia and horses in America, all kinds of animal products and all kinds of domestic animals have shared in the advance in prices. The price advance which began almost immediately with the Kaiser's defiance of civilization in 1914 culminated in 1918. Record prices, both for market stock and for pure-bred animals, were broken right and left. For example, on the Chicago market, native beef steers reached a price of \$20.50 per 100 pounds live weight on December 11, 1918, with an average price for the year of \$14.65. A car-load of hogs sold at \$20.95 per 100 pounds in September, 1918, and the average for the year on the Chicago market was \$17.45, excluding pigs. Lambs had an up-and-down time of it, but broke records also, Colorado lambs bringing \$22.10 in April, and outselling spring lambs for the first time.

Prices for pure-bred animals have been the highest known, all breeding nations sharing in the general prosperity. A Shorthorn bull in Argentina at \$39,600, a Hereford in the United States at \$31,000, an American Berkshire boar at \$10,000, and a Holstein bull calf in the United States at \$100,000 are reported sales indicative of the confidence breeders have in the future of the breeding business. A sale average of \$1,865 from one of our leading Shorthorn herds marks a record for this breed second only to the New York Mills sale.

One of the most remarkable developments of the year was the Hereford "boom" in England. The dispersal of the well-known Hayter herd brought an average of \$2,556.12, the top being the bull Ringer at \$43,200. About the same time, a former owner of Ringer sold one of that bull's sons for \$35,400. No better indication of confidence in the future

outlook of live-stock breeding can be found than in Great Britain, the home of most of our improved breeds of live stock, and it is a significant fact that nearly all the animals sold during the year at the 1918 British sales were bought by British breeders for British herds and flocks. The export trade has had little to do with these prices. British breeders are laying the foundation for the work of the reconstruction period.

The insatiable demands for meat directly or indirectly due to the war have been wonderfully well met by American live-stock farmers. Europe's home supply of meat and milk has declined sharply, owing in part to the actual loss of animals but more to the shortage of the concentrates needed for meat and milk production. During the last year of the war shipping space was at a high premium. Every ship the Allies could spare was thrown into the trans-Atlantic service in order to rush American soldiers to the battle front. Bulky freight could not be shipped unless it was of a military character. Food for human beings therefore had precedence over feed for animals. It takes less shipping space to send to Europe a ton of bacon, beef, or condensed milk than it does the feed required to produce this amount of food. Europe in consequence had to get along as well as she might without feedstuffs from America. America, therefore, sent meats and other animal products in enormous quantities.

It was a feat of which the American farmer has every reason to be proud. For more than 10 years every agency in the United States which is in touch with agricultural progress has urged an increase in beef production. The peak in cattle production in the United States in proportion to population was reached in the census year 1900. In that year there were 89 head of cattle of all kinds per 100 of the human population, in 1910 there were 67, and the number was 64 on January 1, 1919. The number of cattle other than dairy cows was 67 per 100 people in 1900, as many as the number of all cattle 10 years later. Other cattle decreased to 45 per 100 people in 1910 and stood at 42 on January 1, 1919. There has, therefore, been a marked disparity between our increasing population and our beef supply since the year 1900. In fact, at the opening of the war we had actually

ceased to play an important part in the export fresh-beef trade. For the fiscal year which ended June 30, 1914, we exported less than 7,000,000 pounds of fresh beef. However, our beef-cattle stocks were slowly increasing and we were therefore in a better position to furnish a considerable quota of beef for European needs than if the decline of 1890 to 1910 had not been checked. Dairy cows have held quite steady during the last 30 years; we had 26 for each 100 of the population in 1890, 23 in 1900, 22 in 1910, and 22 on January 1, 1919. The pork supplies sent abroad in such staggering volumes have been partly made up by the usual surplus, which, however, had been declining before the war, and also by an increase in production, especially in 1918. Lamb, mutton, and poultry products have not been exported in any important quantity, but these products played a vital rôle in releasing for export other foods, such as beef and pork products.

An important source of meat and dairy products for Europe was obtained by actual sacrifices on the part of the American people. The moral effect of these sacrifices on the people of England and France was of the utmost importance. Next to the military service, nothing America has done is so much appreciated among the allied nations as the Nation-wide movement in the United States to reduce meat and wheat consumption by voluntary effort. In the United States the sentiment against any one who refused to live up to the rules of the Food Administration was such that people were branded as "slackers" if they did not observe the published rules. England used meat and sugar cards and France bread and sugar cards. Each person's allowance was definitely fixed and beyond his allotment he could not go. If he wanted to eat a week's allowance in a single day he could do so, but he could get no more until the next week.¹

WHAT HAS EUROPE DONE?

As a member of the American Agricultural Commission to Europe, the writer was charged specifically with the study of live-stock conditions. He was instructed to ascertain

¹The writer was in England on the first gasoline-saving Sunday in the United States. The success of that effort made a great impression on the minds of British people.

(1) how well farmers and breeders in the allied countries were meeting the war's demands and keeping up their herds, (2) what more American live-stock producers could do than they were already doing in order to hasten the successful termination of the war, and (3) what assistance, if any, America could render in the work of live-stock reconstruction.

THE MAINTENANCE OF HERDS.

The fear has been freely expressed that the war has caused a slaughter of live stock which is almost irreparable. It is true that in some regions the damage done both directly by invasion and indirectly by shortened feed supplies, especially high-protein cakes, has been considerable. The invader wielded a two-edged sword, and he wielded it with one eye cast on the greatest possible damage to the enemy and the other on the greatest possible amount of benefit to Germany in the economic reconstruction after the war. The iron and coal fields of Belgium meant raw material to German factories; the Germans seized them. The French sugar-beet industry meant competition in the world's markets with German sugar; the German armies destroyed three-fourths of the beet-sugar factories in France. The German farmers of the Rhine provinces had envied for years the fine draft horses of Belgium; the Germans compelled the sale at public auction of all but a few which were quickly rushed across the Dutch border, and to-day there is scarcely a horse left in Belgium except those used for military purposes. The invaded territory of France is regarded by the French as swept clean of domestic animals, and probably rightly so. Serbia and other invaded countries doubtless suffered in a similar manner. What has occurred in the great unknown—Russia—and what will happen there before conditions become settled can only be conjectured. If people starve to death in Russia, which travelers just out of Russia say will happen, many animals will starve also, but the starvation of human beings will be most acute in the cities and there may be rough forage enough in the country districts to pull the animals through. However, the almost complete demoralization of Russia has extended to the farms, and production of farm products fell off pitifully in 1918.

How many animals have been lost in Europe as a whole is therefore largely guesswork. An estimate of 100 million head has been made in the United States, and a Canadian authority has been recently quoted with a larger estimate. I venture the opinion that the total figure does not exceed 75 million and probably is nearer 50 million. By far the largest part of this total is sheep and hogs, both of which come back quickly.

LOSSES IN THE UNITED KINGDOM.

The commission was somewhat prepared to learn that the decline of animals in the United Kingdom and France had been less than at first reported. The official figures available before we left Washington indicated as much. On our arrival in England the 1918 agricultural statistics had just been published, and from official British sources the following figures are compiled showing live stock in the United Kingdom and its component parts for 1909, 1914, 1917, and 1918.¹ The figures are for June 4 of each year.

Live stock in the United Kingdom.

MEAT ANIMALS.

Division and class.	1909	1914	1917	1918 ²
United Kingdom:				
Cows and heifers.....	4,360,982	4,595,128	4,514,803
All cattle.....	11,761,830	12,184,505	12,382,236
Sheep.....	31,839,799	27,963,977	27,867,244
Pigs.....	3,543,331	3,952,615	3,007,916
England and Wales:				
Cows and heifers.....	2,359,066	2,484,220	2,464,794	2,577,970
All cattle.....	5,844,817	5,877,944	6,227,148	6,200,490
Sheep.....	20,290,154	17,259,694	17,169,857	16,475,180
Pigs.....	2,251,068	2,481,481	1,918,541	1,697,070
Scotland:				
Cows and heifers.....	435,110	453,703	441,802	451,949
All cattle.....	1,176,165	1,214,974	1,209,859	1,208,696
Sheep.....	7,328,265	7,025,820	6,873,234	6,863,168
Pigs.....	129,819	152,768	132,945	127,615
Ireland:				
Cows and heifers.....	1,566,806	1,657,205	1,608,207
All cattle.....	4,740,848	5,091,587	4,945,229
Sheep.....	4,221,380	3,678,463	3,824,153
Pigs.....	1,162,444	1,318,366	956,430

¹ The writer is indebted to Mr. E. B. Shine, head of the live-stock branch of the English Board of Agriculture, for their figures.

² Figures for Ireland not available.

Live stock in the United Kingdom—Continued.

HORSES ON FARMS.

Division and class.	1909	1914	1917	1918
United Kingdom.....	2,091,743	2,237,783	2,190,318
England and Wales.....	1,348,503	1,399,547	1,372,822	1,375,830
Scotland.....	204,490	209,360	210,048	209,883
Ireland.....	528,806	619,028	597,692

Without going into extensive detail, the reader's attention is called to the following facts: There are practically the same number of cows and heifers and more cattle of all kinds in the United Kingdom than at the outbreak of the war and considerably more than in 1909. In England and Wales this is especially marked. Sheep have declined considerably, especially in England and Wales, but are apparently more numerous in Ireland than at the outbreak of the war, although fewer than in 1909. Pigs have fallen off sharply. Horses have held their own very well during the war and are more numerous than in 1909.

The most serious problem the live-stock farmers confront in Britain at present is the supply of concentrates. The country went into the winter with a fraction of the amount of cake usually on hand and very little in sight. When we left for home, the war was still in progress and the ministry of food had announced that no concentrates would be available for fattening pigs. Preference was given to dairy cows, work horses next, and then breeding animals and young stock (dairy heifers, etc.). There was very little prospect for cattle fattening during the winter, both because of the cake shortage and because of a short and poor root crop. Word coming from England during Christmas week indicates that the situation has improved somewhat, as concentrates are being allowed to pigs.

BRITISH BREEDERS CONFIDENT.

A visitor to Great Britain is impressed with two outstanding facts in her live-stock industry: (1) The breeders have managed to get along very well in the face of a prolonged

war and have maintained the number of their herds remarkably well, and (2) they have the utmost confidence in the future.

Only pigs and sheep have declined in numbers in the United Kingdom. The reason for the decline in pigs is easy to determine. British farmers do not raise pigs on grass. They use kitchen waste and dairy by-products, but, above all, grain offals and other concentrates. Of course, the pinch in the supply of grain caught the pig raisers. The total number raised is small, however, and the industry is of less importance to British farming than the sheep industry. So England depended on American pork products and let her own production lag for the period of the war. There is no indication, however, that the supply of choice breeding pigs was not kept going. Many herds did not have feed enough and the sows were in pretty thin condition. A college herd which the writer saw did not have feed enough to grow out the pigs.

The sheep industry is in a more serious situation all over Europe than any other animal industry. England has been rather hard hit and her flocks have shown quite a decline, especially where they were run on a succession of forage crops, "pastured," as the English say. These sheep require a considerable amount of skilled labor, and the difficulty of getting it caused the sale of some flocks. High prices in 1917 tempted many farmers to sell, as fat ewes brought as much as live wethers of equal weight. In Scotland and northern England a severe storm in April, 1917, in the midst of the lambing season, caused heavy losses. So far as the writer could ascertain the flocks which have been sold in Britain are those producing market stock. Pure-bred flocks are too valuable to sacrifice, and though there were many threats of sales for various reasons there are few if any actually recorded cases of pure-bred flocks being sold to the butcher.

British breeders universally have confidence in the future outlook for the live-stock business. This is the reason why one does not see any evidence of slaughter of breeding stock. As a class British breeders are preparing for an active demand for breeding animals after the war.

FRENCH LOSSES.

Crossing the channel to France, we find that actual invasion has caused losses of a serious character. The number of sheep is about 6,000,000 less (40 per cent), horses 1,000,000 less, pigs 3,000,000 less, and cattle 2,000,000 less than before the war. Perhaps half the loss in meat animals is represented by the number in the invaded districts, which the French assume to be entirely lost and which no doubt are mainly destroyed. The loss in horses represents about the net destruction of Army horses. No one in France is worrying about the pig situation. There are sufficient supplies of breeding animals to come back quickly to normal production.

Neither does the cattle situation seem to give every one the concern that the sheep situation causes. The cattle population has not suffered since the first shock of the invasion. That caused a decline of 2,000,000 head in the first year of the war. Since 1914 the number of cattle in France has declined less than 2 per cent and there are now more young cattle than before the war. In some parts of the country the cattle have actually increased in numbers since the beginning of the war. If, therefore, the country can prevent the slaughter of the young stock now growing up, some authorities believe that in 10 years France will have more cattle than ever before in her history.

We found all authorities in France deeply concerned about the sheep situation. A drop from 16,000,000 to 10,000,000 head during the four years is indeed serious, especially when wool and mutton are in great demand. The extremely high prices have had much to do with it, but the labor shortage is probably the principal reason, and the invasion itself accounts for about one-sixth of the total loss. The majority of French farms are unfenced. Cattle are tethered out and sheep herded. Shepherds went into the army, and it has been found very difficult to replace the skilled shepherds with the labor material available.

Numbers in French herds before and during the war.¹

Class.	Dec. 31, 1913.	Dec. 31, 1914.	June 30, 1915.	June 30, 1916.	June 30, 1917.
Cattle:					
Bulls.....	284, 190	231, 653	211, 343	221, 300	214, 764
Steers.....	1, 843, 160	1, 394, 384	1, 262, 315	1, 321, 887	1, 295, 120
Cows.....	7, 794, 270	6, 663, 355	6, 346, 496	6, 337, 799	6, 238, 690
“Breeders” (over 1 year).....	2, 853, 650	2, 549, 417	2, 581, 870	2, 678, 837	2, 677, 870
“Breeders” (under 1 year).....	2, 012, 440	1, 829, 434	1, 884, 825	2, 032, 102	2, 016, 860
Total cattle.....	14, 787, 710	12, 668, 243	12, 286, 849	12, 723, 946	12, 443, 304
Sheep:					
Rams over 1 year.....	293, 640	258, 447	239, 832	209, 760	188, 204
Ewes over 1 year.....	9, 288, 460	8, 390, 863	8, 033, 886	7, 143, 685	6, 463, 720
Wethers over 1 year.....	2, 580, 810	1, 881, 295	1, 572, 236	1, 411, 211	1, 139, 320
Lambs.....	3, 968, 480	3, 507, 756	3, 637, 235	3, 314, 555	2, 795, 350
Total sheep.....	16, 131, 390	14, 038, 361	13, 483, 189	12, 079, 211	10, 586, 594
Pigs:					
Boars.....	38, 560	36, 179	31, 501	27, 631	26, 090
Sows.....	906, 790	802, 858	785, 989	660, 631	628, 040
Pigs for fattening.....	2, 800, 760	2, 226, 456	1, 632, 252	1, 317, 432	1, 300, 840
Pigs under 6 months.....	3, 289, 740	2, 859, 994	3, 041, 054	2, 442, 404	2, 245, 310
Total pigs.....	7, 035, 850	5, 925, 487	5, 490, 796	4, 448, 366	4, 200, 280
Horses.....	3, 231, 000	2, 105, 000	² 2, 156, 000	² 2, 246, 000	2, 283, 000

¹ From *Le Troupeau Français après trois ans de Guerre*, Paris, Ministère de l'Agriculture, 1918, and reports on file with U. S. Bureau of Crop Estimates.

² For Dec. 31.

Obviously considerable liquidation resulted. No one is sure where French farmers will get the stocks to recuperate rapidly the French sheep-breeding industry. The United States has no sheep to spare, and the French may turn to Argentina or Australia.

Although the nation has suffered much greater actual losses in animals than has Great Britain, the big live-stock problem in France this winter (1918-19) is the feed supply. French farmers are not quite so dependent on oil cakes as their neighbors across the channel, because they grow more legumes, alfalfa, clover, etc. However, the armies are calling for great supplies of forage, and the prices for all kinds of feed are so high that the providing of winter maintenance is a difficult problem. They see the future much as do the British farmers, namely, that there is bound to be a good

demand for all kinds of breeding animals for some time to come and that if they can prevent the slaughter of young animals now maturing they will somehow manage to find the feed to support them.

French farmers were sending beef cattle to market in excessively large numbers in October. During the week of October 14 nearly 10,000 beef cattle were received at the Villette market in Paris, a greater number than during pre-war times. In one day during that week 15,000 sheep were received, which is about the same as before the war. The pasture season was about over and there was no feed in sight to carry fat stock into the winter or to do more than supply rough feed through the winter until grass comes again. England's problem is similar, and a shortage of native beef was regarded as certain from January to June in both France and England. The temptation to slaughter young cattle and cows will therefore be stronger in France than in England, for France has not used refrigerated beef to any great extent, except for the Army. The agricultural authorities hope that supplies of refrigerated beef will be adequate to keep prices down and that civilians will eat it rather than insist on having native beef. Good supplies of meat from America will therefore help French farmers materially to prevent further loss in their herds.

Taken as a whole, therefore, French herds will be in a fairly good position to do their share in restocking decimated herds after the war.

BREEDING HERDS IN CENTRAL EMPIRES.

What the condition of the herds in the central empires is no one could tell us. However, the loud complaints of food shortage for human beings in Germany were not found to have much foundation in fact when our armies got into German territory, and it is a reasonably safe assumption that there has also been enough rough feed available for the actual maintenance of breeding stock. It is hardly likely that a people with such an eye to the main chance as the Germans would overlook the demand after the war for breeding animals, especially when the demand would come from adjacent territory.

POSSIBLE OUTLET FOR AMERICAN DAIRY COWS.

The milk supply has been acutely deficient somewhere in Europe almost from the beginning of hostilities, because there has not been concentrated feed enough to keep up the milk flow of the cows. Breeding cattle can get along pretty well on coarse fodder, but milk cows must have concentrates, especially when good pasture is not available. The loss of dairy cows in invaded areas must be made good as quickly as possible, and America may be drawn on for such animals. This can be considered a possibility of future trade developments but not by any means a certainty.

WHAT AMERICA CAN DO.

As a matter of fact, European farmers are not going to buy meat animals or dairy cows in the United States or anywhere else beyond the seas if it can be avoided. It is not natural that they should. They will first draw on the nearby supplies with which they are familiar and which are already acclimated. However, America has a direct and very great interest in the rebuilding of the live-stock industry of Europe, both for humanitarian and for strictly business reasons. Our greatest service now and our best business policy is to furnish Europe with meat and dairy products, enabling European farmers to concentrate their entire efforts on the conservation of breeding herds and avoid all unnecessary slaughter. The more Europe can draw on us for these products, the more rapidly she can restock and resume normal operations.

In this connection the shipping situation must not be overlooked. It will be some time yet before the world has restored the damage done by the German U-boats. Therefore, shipping space will be at a premium for some time to come. Live animals require a great deal of room on shipboard, and freights are, of course, very expensive. It is much better from every standpoint to ship animal products, such as meat, condensed milk, butter, and cheese, than to ship live animals.

THE HORSE SUPPLY.

The horse industry presents an entirely different aspect. While British horses are quite as numerous on farms as before the war, there has been such a large increase in the

amount of cultivated land in the Kingdom that actually the horse supply is short. Tractors were resorted to, and some of the obsolete English steam plows were brought back into service. In the cities the shortage of horses is most evident and one sees a large number of small donkeys and ponies used for light hauling. In France oxen have always been used much more extensively for farm work than in England, and the army demand on French farmers for horses was met by replacing them with oxen. While the French farms are a million horses below the prewar normal, there is no means of telling just how much effect the replacement has had on the horse situation. It has had some effect, because the price of horses in France is possibly a little less than in England. There is no doubt that breeders of Percheron horses in France have avoided sacrificing mares. The Government has assisted them in their efforts to conserve their stocks and has requisitioned only barren mares. While 1917 and earlier years may have seen some falling off in breeding, all authorities agreed that farmers bred more mares in 1918 than usual. So far as "seed stock" is concerned, French Percheron studs have not been injured seriously. Belgium, of course, was cleared of horses by the invaders, and from the reports current in military circles the Germans were not well supplied with horses during the fall campaigns.

Horses in France and England are from twice to four times as high in price as in America. Ordinary farm work horses sell from \$500 to \$800, and choice geldings suitable for heavy city trucking bring \$1,250 to \$1,650 in Great Britain. The disparity between these prices and those common in the United States will become adjusted in time. How soon that time will come is uncertain. In fact, the opening up of the horse trade from America to Europe depends (1) on the number of horses demobilized from the armies, (2) on available shipping space, and (3) on feed supplies. If the writer were a prophet he would venture on a date somewhere between April 15 and September 1, 1919, with the odds favoring July 1 or thereabouts.

Horses again present a possible exception, in the writer's opinion, to the demand for American breeding stock. Already representatives of the Belgian Government have visited

the United States to determine what, if any, supplies of Belgian horses can be spared from the United States to restock that unfortunate country. It is unknown whether any orders have actually been placed.

The inquiries for Belgian horses are not unexpected. A novel situation is developing in England, however, in the growing interest in Percheron horses in that country. Growing out of the remarkable record of grade Percheron horses from the United States with the British Army, an interest in our most popular breed of draft horse has developed in England which is of unusual historical importance, if, indeed, it does not become important to our breeders financially. Since the beginning of the war a few Percheron horses have been taken from France to England and a British Percheron Society was formed. Now interest is being directed across the Atlantic, and in October a shipment of 26 Percheron mares and 1 stallion from the United States were landed at Glasgow and the animals were sent to Norwich, England, where they now are. There are rumors that the members of the British Percheron Society will look into the supply of available Percherons in the United States before another winter comes.

AMERICAN BREEDERS AND THE FUTURE.

The war in effect is over. American breeders have loyally done their best to support their sons and brothers in khaki and their comrades in the armies of the Allies. What shall be the future course for American live-stock producers? Shall they enter a period of broad expansion or shall they adopt a more conservative policy? The possibilities of America in agricultural production have not been approached. When there is an incentive, especially a double incentive such as we have had in 1918 with wheat and hogs, no one knows what American farmers can do even in the short space of a single season. There were, according to the Bureau of Crop Estimates, 65,000,000 pigs in the United States on September 1, 1918. If there were an average increase of only two brood sows bred on each farm the number of hogs in the United States would be doubled in a year's time. This country is the world's great pork-surplus territory; yet even hungry Europe would find difficulty in con-

suming what we could actually produce in pork if we really extended ourselves to the utmost. Broadly speaking, the corn crop is the limiting factor in American pork production. So long as the crop stays around three billion bushels, the pork surplus will remain somewhat constant, with a rather slow but steady growth of production for local consumption outside that area.

Good advice, therefore, in the hog industry seems to counsel holding steady at present production. In beef cattle we may expect to feel next year the effects of the western and southwestern drought. The slaughter of cows and calves in 1917 and 1918 on account of the drought, which, happily, is now broken, means slaughter of less than the normal number of females in 1919 and 1920. Sheep may be affected by the falling off of the military demand for woolen goods, but fibers will recover more slowly than meats, and meats more slowly than cereals. We should bear in mind that the loss in sheep in Europe seems greater than of other meat animals. While the high wool prices of 1918 can not be expected to continue, future wool prices should be remunerative and the sheep industry profitable, if rationally and intelligently handled and if sheep are protected from prowling dogs.

While accurate information concerning the meat supplies throughout the world unfortunately is lacking, there is reason to believe that the surplus now on hand in the Southern Hemisphere, if there really is a surplus, will be rapidly absorbed as soon as shipping becomes available. There are also the best of reasons to believe that for several years to come European farmers will slaughter a smaller number of meat animals than normally if sufficient supplies of meat can be secured from abroad. They must save so far as possible every female for breeding purposes.

These facts, so far as they go, lead us to believe that American farmers and live-stock producers should pursue a policy of moderate growth, expanding the meat-animal industry in a rational, normal manner, improving methods, introducing more economical methods of feeding and management, and by skill and science reducing their production costs to the lowest possible point.

FEDERAL PROTECTION OF MIGRATORY BIRDS.

By GEORGE A. LAWYER,

Chief U. S. Game Warden, Bureau of Biological Survey.

BIRD PROTECTION AN ECONOMIC QUESTION.

THE MYRIADS of migratory birds that fairly astounded the early explorers of this country before its virgin forests had been destroyed, its green fields trodden to dust by the feet of tramping millions, or its silences broken by the din of thousands of cities, have inspired the writing of volumes of literature. These volumes have told of the wanton and thoughtless slaughter of the birds, and have given warning of their certain disappearance with the settlement of the country and the usurpation of the forests, fields, and streams that had furnished shelter, food, and breeding places for these feathered hosts. Other volumes have set forth the steps that should be taken to save the birds from the ultimate extinction threatened by the acts of people ignorant of their real economic value, and have told of the annual destruction of millions of dollars' worth of forests and crops by injurious insects formerly kept under subjection by the birds. Yet all the while the birds were actually being exterminated, in spite of such protection as could be afforded by the laws of various States.

The food value and economic importance of the migratory birds of the United States, amounting to many millions of dollars annually, justify the widespread interest in their preservation. Not less important is the esthetic value of birds—the inspiration and stimulus which they give to the moral sense, and the charm and beauty which they lend to the life of all our people. Researches by the Bureau of Biological Survey into the economic value of insectivorous birds have proved that they insure the farmer against outbreaks of insect pests, a most serious menace to the agricultural wealth of the country. Valuable in other ways are the game birds, which not only furnish delightful and pleasing recreation to the great army of American sportsmen, but add materially to the food supply of millions of people.

STATE PROTECTION OF BIRDS.

The measures necessary to insure adequate protection for bird life have been well known, but diversified and selfish

interests have prevented the States from putting these measures into effect. The protection of birds during the mating season and while on their way to and from their breeding grounds has been of prime importance, but until recent years few States have given much attention to this important matter. In fact, any protection by a closed season on hunting is in a large number of States comparatively recent, owing to the generally accepted but erroneous belief that migratory birds need no protection and can be hunted whenever present from the time they make their first appearance in spring and fall.

The growth of sentiment for the conservation of so valuable a resource by preventing destruction through spring shooting of game birds, and by enacting other protective measures, has been notable in the last half century. The number of States affording waterfowl no legal protection has come to be in inverse ratio to the number prohibiting all spring shooting, while between these extremes are all gradations, including partial protection of all species and the permission of more or less spring shooting. The various phases are readily compared by decades in the accompanying tabulation covering the 10-year periods since 1870:

State protection of waterfowl at the end of 10-year periods from 1870 to 1910 and in 1912 and 1918, as reflected by various phases of legislation of the 48 States or of legislation for the territory now covered by them.

Phases of legis ation.	Number of States in the years—						
	1870	1880	1890	1900	1910	1912	1918
Prohibiting all spring shooting.....	1	2	5	9	14	18	31
Prohibiting all spring shooting but protecting only a few species.....	5	3	1	1
Prohibiting spring shooting of a few but protecting all species.....	1	1	2	1
Permitting spring shooting but protecting only a few species.....	2	1	1	1
Permitting spring shooting but protecting a few or all species locally.....	1	1	1
Permitting spring shooting but protecting all species.....	6	17	23	26	24	25	13
Affording no legal protection whatever.....	36	24	17	10	6	3	3

The number of States making efforts to prohibit spring shooting fluctuated from year to year, and some States frequently changed columns. Furthermore, the progress was slow and uncertain, and the laws were not always well enforced. In this progress, our shorebirds have been among the most sadly neglected. Many of the smaller species have not been protected in spring. It thus appears that while birds are adequately protected by the laws of some States, their migratory instincts and seasonal movements are such that the open seasons under State laws added together permit birds to be killed over parts of their entire range during every month of the year.

Unreasonably long open seasons for wild fowl prevail in 13 States, varying in length from five to seven and one-half months. No species can long withstand the drain of incessant shooting during such long open seasons; and the destruction of the breeding grounds of the birds, the increased number of hunters, modern firearms, and improved methods of transportation to regions hitherto remote have made practically certain the utter extermination of our migratory birds if they receive only such protection as the States alone are able to afford.

FEDERAL MIGRATORY-BIRD LAW OF 1913 AND ITS REPEAL.

The long and futile efforts of the States finally convinced State game commissioners, sportsmen, conservationists, and others that the uniform and adequate preservation of migratory birds and an equalization of hunting opportunities depended upon the exercise of a supervisory jurisdiction on the part of the Federal Government. To this end a bill was introduced in Congress in 1904, but it was so novel in its objects and legal character that it failed of passage. From the time of its introduction, however, the subject was kept before Congress in one form or another almost continuously until the enactment of the migratory-bird law of 1913.

This Federal statute merely conferred on the United States Department of Agriculture the power to fix closed seasons during which it would be unlawful to capture or kill migratory birds. For this reason, it proved very imperfect and

quite incapable of effective enforcement, but it exerted a wonderful influence upon the public mind, and its passage laid the first real foundation for the actual preservation of our migratory birds.

The regulations adopted under this act enjoined spring shooting throughout the United States, and the extent of their observance is a splendid tribute to the sportsmen of the country. Fully 95 per cent of the sportsmen abided by this mandate and refrained from hunting during the closed seasons. The result was almost instantaneous. Waterfowl and other migratory game birds at once not only showed a marked increase in numbers, but, owing to the cessation of spring shooting, remained unmolested in ever-increasing numbers to breed in places from which formerly they had been driven every spring by incessant shooting. At the end of the 5-year period during which this law was in operation, State game commissioners, leading sportsmen, and conservationists were practically unanimous in their expression that wild fowl were more abundant than at any time in the 25 years preceding, and in attributing this increase to the abolition of spring shooting and the general observance of the Federal statute.

The very marked improvement in conditions under this law instilled a new spirit into sportsmen and showed the wonderful possibilities under a Federal law broad and comprehensive enough not only to protect the birds during the mating and breeding season, but to equalize hunting privileges and opportunities by removing the incongruities still existing under State laws.

The constitutionality of the law was attacked in the courts, but before it was passed upon by the United States Supreme Court the law was repealed by the enactment of more effective legislation in 1918. The constitutionality of the law of 1913 thus became a dead issue and on motion of the Attorney General the appeal in the case¹ was dismissed on January 6, 1919. In its action the court did not pass upon the constitutionality of the law and this now remains a moot question.

¹ United States vs. Harry Shauver.



PHOTO BY HERBERT K. JOB. B1123M

RESULTS OF PROTECTION OF MIGRATORY BIRDS.

Blue and snow geese at Vermillion Bay, La. (Photograph used by courtesy of the National Association of Audubon Societies.)



PHOTO BY HERBERT K. JOB. B1147M

FIG. 1.—SCENE IN A TYPICAL HUNTING SECTION OF THE NORTHWEST.
Mallards in slough by Lake Winnipegosis, Manitoba.

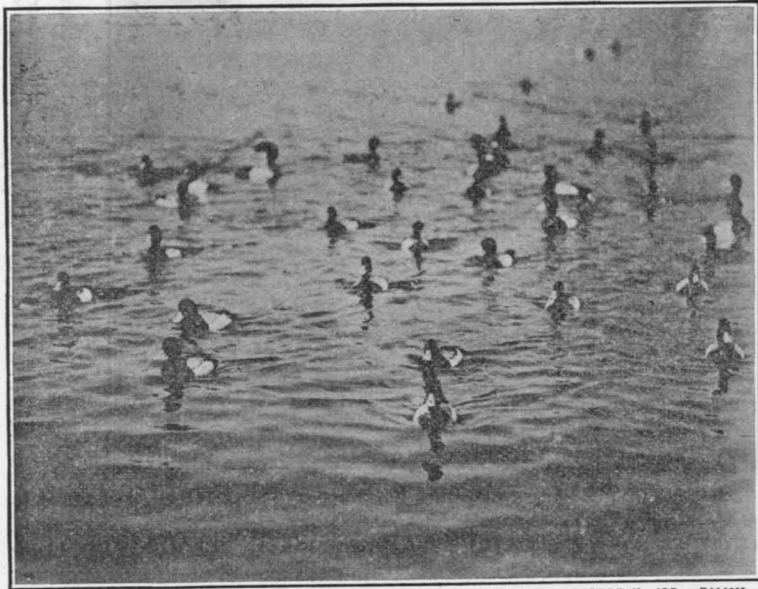

PHOTO BY HERBERT K. JOB. B1146M

FIG. 2.—LESSER SCAUP DUCKS, PALM BEACH, FLA.
When protected, wild ducks become remarkably tame.



PHOTO BY HERBERT K. JOB. B1124M

A SCENE THAT THRILLS THE HUNTER.

"Pintails! Get down! Here they come!"

THE MIGRATORY-BIRD TREATY.

When the migratory-bird law was passed, sportsmen and conservationists had in mind the enactment not only of a more comprehensive Federal statute but of uniform international legislation, such legislation as would insure adequate protection to birds on their breeding grounds and in their winter homes. To this end the United States Senate in 1913 adopted a resolution memorializing the President to negotiate treaties with other countries for the protection of migratory birds. As a result of negotiation thus initiated a treaty between the United States and Great Britain for the protection of birds migrating between the United States and Canada was concluded at Washington, August 16, 1916, and ratified December 7 of the same year. Altogether, 537 species of migratory birds are included in the various families protected by the treaty, and all individual birds of each of these families or species are included, even though a few individuals may be found within the borders of any State the entire year. In other words, if a few individuals of any species of migratory bird remain for an indefinite period in a particular State this fact does not take from them their migratory character and thus remove them from the operation of the law.

BIRDS NOT PROTECTED BY THE TREATY.

The treaty does not, however, include the gallinaceous birds, as quail, pheasants, grouse, and wild turkeys, and these still remain wholly within the jurisdiction of the several States. Approximately 220 species of migratory birds also are excluded from the terms of the treaty because they are not specifically named or do not feed chiefly or entirely on insects. Included among the unprotected birds are the skimmer, albatross, tropic bird, anhinga, cormorant, pelican, man-o'-war bird, flamingo, roseate spoonbill, ibis, jabiru, limpkin, hawk, owl, parrot, trogon, kingfisher, becard, horned lark, crow, jay, starling, blackbird, sparrow, phainopepla, thrasher, and mockingbird.

TERMS OF THE TREATY.

The treaty provides for continuous protection for migratory insectivorous birds and certain other migratory non-game birds; special protection for 5 years for wood ducks and eider ducks; a 10-year closed season for band-tailed pigeons, little brown, sandhill, and whooping cranes, swans, curlews, willet, upland plover, and all other shorebirds (except black-bellied and golden plovers, Wilson snipe or jack-snipe, woodcock, and the greater and lesser yellow-legs); and confines hunting to seasonable periods of not exceeding three and one-half months for the shorebirds not given absolute protection, and other migratory game birds.

THE MIGRATORY-BIRD TREATY ACT.

The treaty provides no machinery to enforce its provisions, but the High Contracting Powers agreed to enact necessary legislation to insure its execution. In pursuance of this agreement, the Government of the Dominion of Canada passed the migratory-birds' convention act, which became a law on August 29, 1917; and the Congress of the United States passed the migratory-bird treaty act, approved by the President on July 3, 1918. The enactment of this legislation rounded out the most comprehensive and adequate scheme for the protection of birds ever put into effect.

Under the migratory-bird treaty act, it is unlawful to hunt, capture, kill, possess, sell, purchase, ship, or transport at any time or by any means any migratory bird included in the terms of the treaty except as permitted by regulations which the Secretary of Agriculture is authorized and directed to adopt, and which become effective when approved by the President. The act provides police and other powers necessary for its effective enforcement.

CONSTITUTIONALITY OF THE TREATY ACT.

If it is conceded, as it must be, that valuable game and insectivorous birds which migrate between the United States and Canada are a proper subject for the negotiation of a treaty, there seems to be little likelihood that the migratory-

bird treaty act of July 3, 1918, will be effectively attacked on the grounds of constitutionality, because the Constitution of the United States provides that "all treaties made, or which shall be made, under the authority of the United States shall be the supreme law of the land; and the judges in every State shall be bound thereby, anything in the constitution or laws of any State to the contrary notwithstanding."

EFFECT OF THE TREATY ACT ON STATE LAWS.

The migratory-bird treaty act renders inoperative all State and local laws that are inconsistent with it, but it authorizes the several States to make and enforce laws not inconsistent with the terms of the act or of the treaty, which shall give further protection to migratory birds and their nests and eggs; but the open seasons may not be extended by the States beyond the dates fixed by the Federal regulations.

The Federal Government in effect has assumed a limited jurisdiction over migratory birds in order to insure their adequate protection. The States may not permit anything to be done which is prohibited by the Federal Government, but they may enact and enforce laws or take other measures conforming to the provisions of the Federal regulations or not in conflict with the operation of the Federal law.

It seems quite clear that no State or subdivision of a State can permit migratory birds to be hunted, killed, possessed, sold, or transported at times, by means, or in numbers made unlawful by the Federal act, but confusion arises from the existence, at the time of the enactment of the Federal statute, of closed seasons under State laws which overlapped either wholly or in part the open seasons prescribed by the Federal regulations. If it is clear that a person is not authorized to hunt migratory birds during that portion of a State open season which is a part of a Federal closed season, it must be equally clear that a person may not hunt during that portion of the Federal open season which is included in the State closed season, as hunting during that time would be in violation of a law which the State is authorized to make and enforce.

To ascertain the period when migratory birds may be hunted without violating either Federal or State laws, there

must be deducted from the Federal open season that portion of a State closed season which is included in it.

The right of a State to circumscribe the privileges permitted by the Federal regulations extends also to daily bag limits, possession, transportation, and export of birds. Persons committing acts permitted by the Federal regulations but prohibited by State laws are amenable, however, to the State, and are not subject to prosecution by the Federal Government.

INTERSTATE AND INTERNATIONAL TRAFFIC IN BIRDS.

That portion of the United States Penal Code known as the Lacey Act, which prohibits the illegal interstate shipment by common carrier of dead bodies of wild birds, has also been superseded by the treaty act, which prohibits the carriage or shipment of both dead and live birds (migratory as well as nonmigratory) out of a State by any means whatever contrary to the laws of the State in which the birds were killed, or from which they were carried or shipped.

The provision of the Lacey Act relating to the interstate shipment of wild animals and parts thereof and the penalty for knowingly receiving illegal shipments still remain in force.

REGULATIONS UNDER THE TREATY ACT.

The first regulations under the migratory-bird treaty act were adopted by the Secretary of Agriculture, after careful consideration of recommendations and suggestions, and became effective on the approval of the President, July 31, 1918. Amendments were adopted effective October 25, 1918.

The regulations are prepared by the Secretary of Agriculture, with the assistance of the Bureau of Biological Survey and an advisory board of 21 members representing all sections of the country, a majority being State game commissioners or their representatives and the remainder well-known sportsmen and conservationists of wide experience. The members of the board possess no administrative or executive powers, but their thorough knowledge of conditions and requirements enables them to offer valuable suggestions in connection with the preparation of the regulations. Regulations thus prepared are calculated not only to give ade-

quate protection to the birds, but also the highest degree of satisfaction to the greatest number of sportsmen and others interested in the conservation of our migratory birds.

SEASONS FOR KILLING MIGRATORY BIRDS.

The only migratory game birds that under the regulations may be lawfully hunted are waterfowl (except wood duck, eider ducks, and swans), rails, coot, gallinules, black-bellied and golden plovers, greater and lesser yellow-legs, woodcock, Wilson snipe or jacksnipe, and mourning and white-winged doves. Practically uniform periods, not exceeding three and one-half months, between September 1 and February 1, are prescribed as the open seasons for hunting these birds, except that the open season for black-bellied and golden plovers and greater and lesser yellow-legs in the States bordering on the Atlantic Ocean and situated wholly or in part north of Chesapeake Bay is from August 16 to November 30 (figs. 15 and 16).

RESTRICTIONS ON TAKING, POSSESSING, AND TRANSPORTING BIRDS.

Under the law and regulations, it is unlawful to capture or kill migratory game birds, except with a gun not larger than No. 10 gauge, or to hunt, kill, or attempt to hunt or kill birds from airplanes, power boats, sailboats, or any boat under sail. Power boats and sailboats may be used to take gunners to and from the hunting grounds, but shooting or attempting to shoot migratory birds from them is prohibited. Nor can such boats be used to harry, worry, or disturb the birds in any manner.

Uniform bag and export limits are fixed by the regulations. Under the export regulations, not exceeding two days' bag limit may be sent out of a State by one person in one calendar week. No restrictions are placed on the number of birds that may be shipped within the limits of a State, such shipments being governed entirely by State laws.

Any package in which migratory game birds or parts thereof are transported or carried, whether within or without a State, must have conspicuously marked on the outside the names and addresses of shipper and consignee and an accurate statement of the numbers and kinds of birds contained.

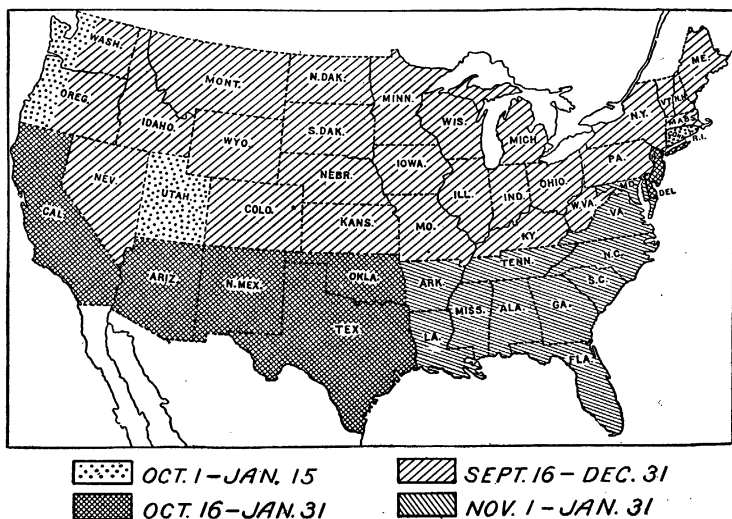

FIG. 15.—Open seasons fixed by Federal regulations adopted in 1918 for waterfowl (except wood ducks, eider ducks, and swans), coot, gallinules, and Wilson snipe or jacksnipe. Wood ducks, eider ducks, and swans are protected for a term of years under the provisions of a treaty between the United States and Great Britain for the protection of birds migrating between the United States and Canada.

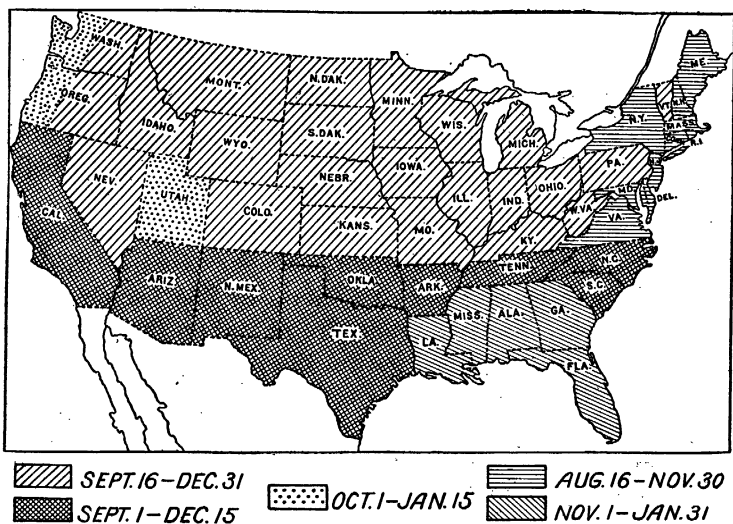

FIG. 16.—Open seasons fixed by the Federal regulations adopted in 1918 for black-bellied and golden plovers and greater and lesser yellow-legs.

SALE OF MIGRATORY BIRDS PROHIBITED.

The hunting of migratory game birds for the market has contributed perhaps more than any other cause to the depletion of the supply, and has created an almost universal demand for laws prohibiting their sale. As a necessary measure to conserve the supply and increase the breeding stock, the regulations do not provide for the sale of any migratory birds, except for scientific or propagating purposes under permit, and as a consequence it is unlawful to sell wild ducks or other migratory birds for commercial purposes anywhere in the United States. For many years most States have had laws prohibiting the sale of game during part or all of the year, but the open markets in near-by States made it profitable for the market hunter to continue in his destructive vocation, as it was always possible for him surreptitiously to ship the birds to the markets where they could be sold lawfully. The closing of the markets will make it more difficult to dispose of the birds and will remove the incentive to slaughter them in such large numbers. This prohibition against the sale of migratory birds has been very generally approved by sportsmen and conservationists and by the United States Food Administration.

GAME FARMING.

The general prohibition against the sale of migratory birds has created a great demand for domesticated birds to supply the market. To meet these demands, the regulations under the treaty act make suitable and liberal provisions for the propagation of migratory waterfowl. These provisions apply to all persons who possess migratory waterfowl for any purpose.

Permits are issued free of charge by the Secretary of Agriculture, through the Bureau of Biological Survey, authorizing persons to acquire a limited number of wild waterfowl, to be used as the nucleus of a breeding stock or to strengthen the strain of birds already possessed, and to possess and traffic in domesticated migratory waterfowl for food purposes.

Aside from the necessity of obtaining Federal permits, marking packages in which the birds or eggs are shipped, and reporting to the Secretary of Agriculture on operations

under the permits, the breeding and traffic in the birds is carried on entirely under the supervision of the several States.

The fact that many States have enacted no laws on the subject, together with lack of uniformity in the laws of other States, has deterred many persons from engaging in the business, but it has been demonstrated that many species of waterfowl, particularly black and mallard ducks, can be raised profitably on lands unsuited to agriculture and also in connection with agricultural pursuits. There seems to be a growing sentiment in favor of more uniform legislation on the subject in order that domesticated birds may reach the markets with the least inconvenience to the breeders, while at the same time the protection of wild birds may be safeguarded properly. This could be accomplished in a simple and inexpensive manner if a marking and tagging system, similar to one that has been in successful operation in New York State for many years, were adopted. Enactment of proper laws by all States, giving full recognition to this legitimate business, would encourage persons to propagate wild fowl in captivity, thus materially adding to the food supply and affording a pleasant and profitable occupation for a large number of people.

CONTROL OF BIRD DEPREDATIONS.

Despite the almost general usefulness of birds, certain species at times become seriously injurious to crops in some localities. Recognizing the importance of controlling such depredations, the regulations make suitable provision for the issuance of permits to kill any migratory birds which become seriously injurious to agricultural or other interests, but the birds so killed can not be shipped or sold.

The control of the depredations of wild ducks in the rice fields of California during the fall of 1918 furnishes a striking example of the successful operation of this provision of the law. After a careful investigation of conditions in the rice belt, a blanket Federal permit was issued authorizing rice growers to kill wild ducks when necessary to protect the rice from damage. This permit insured the rice growers protection from the destruction threatening their crops, while the restrictions carried in the permit regarding shipment and sale afforded the birds ample protection.

In the Southeastern States a similar destruction of rice fields has threatened in the invasions of hosts of bobolinks, commonly known there in fall as rice birds and farther north as reed birds. During the spring and summer months the bobolink renders valuable services as a destroyer of injurious insects, but late in the summer and in fall it changes its habits and inflicts serious damage to crops, especially in certain Southeastern States, where rice growing has again begun to flourish. An investigation by the Biological Survey showed that the depredations of the bobolink in the fall of 1918 resulted in losses to rice growers in this section of about \$150,000. The birds descended on the rice fields in such numbers and were so heedless of efforts to drive them away that it was apparent that the only effectual remedy would be to shoot them when in the rice belt and when migrating in that direction.

The Secretary of Agriculture, therefore, issued a permit on January 17, 1919, authorizing the shooting of bobolinks from one-half hour before sunrise to sunset from September 1 to October 30 in New Jersey, Pennsylvania, Delaware, Maryland, and the District of Columbia; and from August 16 to November 15 in Virginia, North Carolina, South Carolina, Georgia, and Florida. Birds so killed are not to be sold, offered for sale, shipped for sale, or wantonly destroyed. They may be used as food by persons killing them or they may be transported for the use of hospitals or charitable institutions. It is believed that action taken under this permit will insure rice growers against the depredations of the bobolink without endangering the species.

ADMINISTRATION OF THE LAW.

In the Bureau of Biological Survey, which has direct charge of the enforcement of the law, are many unusual advantages for administering its provisions. For years this bureau has been investigating the relation of birds to agriculture, their breeding habits, and the times and lines of their migratory flights. It now has about a million and a half migration cards covering a period of nearly 35 years, constituting undoubtedly the most valuable record of this kind in existence. It is also well equipped through its corps of experts and hundreds of collaborators in all parts of the

country to carry on these investigations. A situation presented by unusual conditions occurring in any part of the country is carefully investigated and its relation to conditions in other localities determined. The results of these investigations are disseminated through bulletins and other channels for the benefit of the people of all parts of the country. The bureau is now maintaining most cordial relations with the game authorities of nearly all States, and its entire policy is along the line of assisting States to build up and maintain their bird resources.

FUTURE OUTLOOK FOR MIGRATORY BIRDS.

The Federal laws that have been enacted for the protection of migratory birds will, without doubt, go a long way toward insuring a supply for all time, but the interests of the several States are so inseparably related to the interests of the National Government that all efforts to conserve these birds should be coordinated if the fullest measure of success is to be attained. Much already has been done along this line. The open seasons for wild fowl in 25 States have been made to conform to the seasons under the Federal regulations, and in many other States game commissioners and sportsmen have manifested a spirit of cooperation in game conservation that fairly indicates a very general sentiment favoring uniformity in State and Federal laws.

While the results already achieved are very gratifying, the future promises to restore our migratory birds to such numbers as will afford abundant legitimate sport, recreation, and enjoyment for all the people.

FARM WOODLANDS AND THE WAR.

By HENRY S. GRAVES,
Forester, Forest Service.

THE war was everybody's war, and the farmer's part in winning it was no less important than the cannon maker's. Everybody knows that this was true with regard to food. It was true also with regard to many other things. The woodlands on our farms, for instance, supplied material for propellers to drive airplanes, for treenails to hold wooden ships together, for spokes that went into wagons, trucks, and ambulances, for gunstocks, trench tools, and many other articles necessary in attacking the enemy or in giving comfort to our own men.

The end of the war has brought with it no diminution in the importance of proper utilization and care of the farm woodlands. Above all, it is essential to make the most of the lessons that may be drawn from the war regarding the future of farm woodlands and their place both in the management of the farm and in our national economy.

FIRST WAR DEMANDS.

One of the first war demands was for millions of boxes, crates, and containers of all kinds, both for use in shipping munitions, machinery and equipment, and supplies overseas, and for the needs in this country. Every purchasing branch of the Army and Navy, and the auxiliary organizations like the Red Cross and Y. M. C. A., demanded boxes in immense numbers. While most of the box material used during the war came from the larger lumber enterprises, nevertheless farms supplied in the aggregate large quantities, especially in New England and other regions where an abundance of second-growth white pine and other coniferous timber is found on farm woodlands within reach of existing mills. As the war increased the drain on labor, many small mills had to reduce output or shut down, so that the aggregate production of box material from the farm was not as great

in the later as in the earlier months of the war; yet the service of the woodland on the farm for boxes remained a very substantial one.

Farm woodlands, however, were of even more importance in connection with the hardwoods used for such specialized purposes as wagons, gunstocks, airplane propellers, tools, etc. For some of the special wood materials the Government had to rely very largely upon what could be secured from farm wood tracts. This was because such species as walnut, ash, hickory, and black locust do not occur in great solid forests like pine, hemlock, and fir. They are mixed with other species, and scattered over a very wide area. Nearly half of the second-growth hickory, which is most prized for spokes, tool handles, and other uses requiring specially strong, hard wood, is in the hands of the small owner. The farmer owns also the greater proportion of the black locust. In short, in these special woods, the farmer is not merely a contributor along with large lumbermen; he is a pivotal producer. This means that he will also be the producer of these and many other wood products in the future.

BUILDING MATERIALS IN HEAVY DEMAND.

For the supplies of building material used in the war the Government turned to the established lumber industry, with its multitude of sawmills, backed by supplies of virgin forests of pine, Douglas fir, spruce, hemlock, and other species entering into the general lumber market; and the demand for millions of feet of lumber for cantonments, navy yards, wooden ships, and aircraft tended to throw into the background less conspicuous but equally important war requirements in great variety, which could be met only by drawing large quantities of material from the woodlands of the farms. This material left the farms in small quantities, inconspicuously, sometimes a tree at a time; but, like innumerable rivulets that join to make a great river, the small contributions joined to make up a large and absolutely indispensable stream of war supplies. The farm woodland has acquired a tremendous significance in our national as well as our local forest economy.

BLACK WALNUT MOST VALUABLE WOOD.

In the search for material for gunstocks and airplane propellers, the country was obliged to turn largely to the farm woodlands, for there is to be found most of the black walnut, the best native wood for such purposes. This provided the farmer with an opportunity for patriotic service in disposing of his walnut to firms holding Government war orders, and at the same time with a source of considerable revenue, since the prices paid for black walnut were among the highest ever paid for an American lumber. More than ever, black walnut trees on the farm may now be regarded as a bank account convertible at any time into ready cash. From the time when black walnut rose from a fence-rail wood to the most fashionable furniture material and the premier cabinet wood of the country, it has been a sort of aristocrat among woods; and now, because of the enormous demand for it and its exceptional qualities for gunstocks and airplane propellers, it has been called the "liberty" tree.

Black walnut has many good points. It holds its shape, is relatively free from checking and splitting in seasoning and during later exposure to the weather, is strong without being excessively heavy, withstands shock without injury, is dark in color so that it does not stain easily, and has the cabinet-wood qualities of being easily worked with tools and taking a high finish.

On account of the rapidly waning supply and the urgent war needs, the manufacture of black walnut into other than war materials was practically stopped by the Government, except in the case of wavy or curly grained wood not suitable for gunstocks and airplane propellers.

About 250,000,000 board feet or one-fourth of the total supply of standing black walnut, estimated at 1,000,000,000 board feet, was probably cut for war purposes. It is well, therefore, to consider carefully the matter of restocking the country with this useful and valuable tree. If the farmer will conserve young walnuts already growing and, by planting nuts or walnut seedlings in so-called waste places about the farm, provide a future supply of good timber, he will increase his future income and the sale value of his farm.

BLACK LOCUST FOR WOODEN SHIPS.

Black locust is as important to the wooden-ship builder as black walnut is to the maker of airplane propellers, and to a large extent he has to come to the same place for it—the farm woodland. For most of the ordinary purposes of the lumber industry, black locust is a most unpromising tree, because usually it is not a large nor a very straight tree; but for treenails it has no superior in the world. The treenails are great wooden pins $1\frac{1}{2}$ inches in diameter and from 1 to 4 feet long, which are used to bind together the planking, frames, and ceiling of wooden ships. From 50,000 to 60,000 are required for a single hull. Up to July 20, 1918, the Emergency Fleet Corporation had purchased about 10,000,000 of them, and at that time it was thought that our shipbuilding program would absorb as many more.

Black locust is scattered here and there in small amounts, so that it had to be hunted out somewhat like black walnut, a tree at a time in the woods and pastures and on the farms. The total stand, however, is estimated at 1,000,000,000 board feet, so that the supply is adequate for all anticipated requirements.

CHESTNUT WOOD FOR TANNING.

The connection between the farmers' woodlands and the Army's shoes is not at first apparent; but to secure tanning extract for the immense quantity of heavy leathers required for these shoes placed a decided drain upon the woodlands of the southern Appalachians for chestnut wood and chestnut oak bark, and upon the northern forests for hemlock bark. In order to run the chestnut extract plants of the southern Appalachians to full capacity, a daily production of 3,800 cords of chestnut wood is required, or approximately 1,189,400 cords per year. Farmers throughout this region owning chestnut trees were able to derive a considerable revenue from this source.

ASH AND HICKORY FOR TOOLS AND VEHICLES.

The war uses of ash and hickory were very numerous and gave the farmers an additional market at increased prices for their logs. In airplane construction, ash constitutes

about 15 per cent of the wood used. It is used primarily for the so-called ailerons, which require the best timber in rather long pieces. Large quantities of ash also entered into the handles of such tools as shovels, trench tools, boat-hooks, pike poles, etc. The ship-building program required considerable ash for interior finish as well as for oars for the lifeboats. Ash is also used in vehicles, being especially desired for shafts and tongues; and in harness for hames.

For tools of a different nature, such as axes, picks, carpenters' tools, etc., hickory is the favored wood, and the war demands for these were beyond imagination. War vehicles require considerable hickory, as it is used for ambulance and light truck spokes, and for single and double trees, poles, shafts, and various other parts.

OAK FOR SHIPS AND VEHICLES.

Of the farm woodland trees, probably oak is most plentiful. The best grade quarter-sawed white oak was in some demand for airplane propeller material; but the largest demand for oak was undoubtedly in connection with the ship-building program and the manufacture of army vehicles. The civilian can hardly imagine the number of escort wagons, ration cars, combat wagons, medical carts, ambulances, drinking-water carts, sanitary carts, field kitchens, motor trucks, cable carriers, gun carriages, etc., required by the army program. The chief use for oak in these various vehicles was for spokes. Farmers having good-grade white oak found a ready market for their output.

WOOD FOR ACETONE AND ALCOHOL.

The extra demands upon farm woodlands were not confined to the best grades of timber for products such as have already been indicated, although these were the products which furnish the farmer his greatest opportunity. Wood for fuel and for acetone and alcohol came more and more into demand as our war program expanded. Indeed, we could not have "carried on" without a greatly increased supply.

In the Revolutionary and Civil War days, charcoal made in pits was an important ingredient of powder, but since the advent of smokeless powder, this has become relatively un-

important. To-day charcoal is but a by-product of the destructive distillation of hardwoods, and was not as essential to the war as the acetone and alcohol produced by the process. Acetone is used in the manufacture of propellant explosives for all calibers of guns, and is an important material for use on the wing covers of airplanes, and since from 75 to 100 tons of wood are required to produce 1 ton of acetone, enormous quantities of wood were needed for this purpose alone. After the entrance of the United States into the war, it became necessary to construct several large distillation plants to produce acetone for war purposes. Wood alcohol is also used to a large extent in the manufacture of explosives.

WOOD FOR FUEL.

Among the numerous results of the entry of the United States into the war was the upsetting of the fuel situation. The production of coal not only fell off at the mines, but the transportation facilities of the country were so overburdened that the whole national life was embarrassed during the extremely cold winter of 1917-18. Wood, which has been more and more relegated, as a fuel, to rural districts, was in great demand not only on the farms and in the villages, but even in the cities and industries. It is safe to say that the normal wood production was increased by at least 30 per cent; for wherever wood could be secured by team or auto truck, it was used in large quantities even at the prevailing high prices, which ranged in many places from \$15 to \$20 a cord. The farmers were assured of a ready market for practically all the wood they could produce. The scarcity of labor was the only limiting factor.

The farm woodlands, as never before, have become an important national asset. The war gave the farmer an opportunity to develop this portion of his property because he could market for fuel the low-quality wood which heretofore has in many localities been unmerchantable. In this way poor trees may be removed to make room for more valuable individuals; and the mature trees of the valuable species can be removed at greater profit than ever before. On the other hand, there is a danger that unless proper care is taken, the woodlands may deteriorate as a result of cutting instead of

being improved, as should be the case. The temptation is to remove only the high-priced trees or those easiest to get. To yield to it would inevitably result in the reproduction of the poor species and the rapid deterioration of the woodland. In parts of the South there is the added danger of erosion on scantily covered hill slopes.

WOOD-MARKETING KNOWLEDGE ESSENTIAL.

With the war ended, every facility should be given the farmers, through the cooperation of State foresters and the agricultural extension agencies, to secure more practical knowledge of the marketing of woods products and the improvement of the woodlands. The peace requirements of a rapidly expanding nation will be reflected in the demands upon local supplies of lumber. With the foreign market which will undoubtedly be open to our more valuable timbers, there is likely to be a pressure upon our forest resources which can be met only by efficient management. The farmers are best situated to take advantage of these improved conditions, for the highest farm-labor income can best be secured by a form of diversified farming which will give profitable employment for men and teams during seasons when they are not engaged in the more strictly farm operations.

COOPERATIVE WOOD HANDLING HELPFUL.

In order to organize better the woods industries of the farms, cooperative associations may possibly be developed similar to the cooperative creameries, live-stock shipping associations, and other associations which have done so much for the farmers. Woodland products are particularly difficult for the individual farmer to market profitably because they are harvested intermittently instead of annually and the owner never acquires that proficiency which comes from the constant repetition of the same operation. Another disadvantage is that rough woodland products are so bulky and heavy that, compared with dairy products, vegetables, cereals, or even hay, their marketing is necessarily restricted to relatively small geographical units. There is not, therefore, the same competition among buyers of logs and wood as among the buyers of dairy products, live stock, vegetables, and fruit.

In having logs custom sawed and disposing of the finished product, farmers are likewise at a disadvantage. They are not in touch with the distant markets, and often do not have enough of one grade to make a carload. By cooperating they may find it possible either to dispose of their logs to better advantage to the local mill man, or to operate their own mill, employing a skilled sawyer and grader, and thus marketing their product to much better advantage than has ever before been possible. It may not be too much to expect also that we shall in time have home wood industries similar to those which play an important part in the daily lives of the farmers in France and Switzerland.

WOODLANDS SHOULD BE IMPROVED.

In order to take advantage of the encouraging conditions which are almost sure to develop, the farmer should begin at once systematically to build up his woodlands, using the best information available as to the kinds and character of timber which will be in demand and which will be most profitable for him to produce. Several factors will influence him in his decisions: The relative value of the timber; the rate of growth; the local conditions for marketing; the susceptibility to damage by fire, insects, disease, cattle, etc. It is evident that there will always be a national demand for such high-class timbers as hickory or white oak, though the rate of growth is not as rapid as in the case of some other species. In most cases, greater profit can be derived by raising more rapid-growing, though in some cases less valuable, species, such as red oak, ash, basswood, poplar, and pine. In restricted areas trees like the black walnut can be grown; these combine high value with rapidity of growth. Obviously, a crop which can be matured in 50 years will be far more appealing to the average farmer than one which requires 80 years, even though in each case there are receipts from thinnings during the period of growth.

Too little emphasis has been placed, in the past, upon the importance of thinnings as a source of intermittent income. A forester's statement that it requires perhaps 50 years to mature a timber crop is naturally discouraging to a man of middle life. The fact is, however, that in any well-regulated woodland, especially of any size, periodic cuttings can be made,

removing always the poorer varieties and the inferior specimens and giving the best trees an opportunity to develop into the most valuable classes of lumber. The utilization of all this material, which in a natural woodland dies and goes to waste, adds appreciably to the income which the owner eventually derives from the high-grade stock of the last cutting. In fact, if the income from such intermittent cuttings were placed in a savings bank, or were invested in some interest-bearing security, it would be found by the time of the final cutting to form a very large part of the total income from the crop.

In planning for the best use of farm woodlands, a distinction must be made between those on farms which contain large areas of tillable land, where the woodlot is relatively unimportant, and those on farms in hilly country where the proportion of woodland is relatively large. The first type is common throughout the Central States and in the better agricultural regions of the East. On such farms the woodland will always be a source of home supplies rather than a source of salable material.

TIMBER GROWING FOR HOME USE.

On every farm there is a constant demand for various classes of timber—lumber for barns, etc., fence posts, and fuel wood, to mention only a few. The difference in cost between these materials gathered from the farm and those purchased in the open market is considerable, and can not be neglected in any system of farm accounts. The main effort in the handling of the woodland on such a farm should be directed toward producing a sufficient amount of all woods materials required on the farm. Even farmers who burn coal will occasionally experience a fuel shortage, as in the winter of 1917–18, and a reserve of wood may save a great deal of discomfort.

COUNTY AGENTS SHOULD UNDERSTAND FOREST CONDITIONS.

In the hilly regions where the tillable lands are confined to small areas in the valley bottoms, entirely different problems obtain. In counties having such conditions the plan should be to develop especially the forests and the dependent in-

dustries. The county agent selected for such a county should have some knowledge of forest conditions and should be able to look ahead to the future needs of the county. For such a county the goal would be prosperous communities built on sustained forest yields and small wood-working industries, with small tillable areas serving rather as adjuncts than as the main source of income.

These and many questions of a like nature must receive careful consideration during the years immediately succeeding the war in order that farm forestry may become the practical business proposition that it must be to appeal to the American farmer, who has learned in the school of experience to distinguish to a nicety between what is theoretical and what is practical.

HOW WEEVILS GET INTO BEANS.

By E. A. BACK,

*Entomologist in Charge, Stored-Product Insect Investigations,
Bureau of Entomology.*

READING NATURE'S SIGN LANGUAGE.

THE New England farmer strolling about his small farm during Sunday leisure is quick to read Nature's signs which tell him whether his crops and cattle are growing well. The Hawaiian ranchman mounts his horse and gallops off into the mountains to read the same signs as they appear differently under the semitropic sun. The color of the grass, the level of the water in his springs, or the drip of water from the roof of the mountain cave—all have their meaning to his practiced eye. No one versed in farm life need dig all the potatoes in a field before he knows pretty nearly what the yield will be. The tightly rolled corn leaf spells dry weather; the heating haycock means a blackened, moldy, worthless crop unless immediate action is taken. These signs of nature are too simple to need discussion among farmers. They are recognized facts. They are the common experience of centuries of farm life.

But Nature is just as generous in sharing her knowledge governing all phases of agriculture. She writes her signs large for those who will and can read them. One of the great works of the United States Department of Agriculture has been, and still is, the study of these signs, and the recording of them so that they may be more readily available to those who earn their living by means of agricultural pursuits. Each profession has its sign language; the best farmer is he who learns to use to his advantage the signs that aid him to understand better the forces working against his success.

DETECT WEEVILS BY THEIR SIGNS.

Just as the peach grower can tell by a mere examination of the buds on his trees during the fall whether his trees will blossom well the following spring, if weather conditions are right, so can the grower of beans, peas, and cowpeas, or any

other crop attacked by bean weevils, tell whether his seeds will be weevilly even before the plants have matured in the field. Thanks to the excellent work of the agricultural county agents, and of the agricultural high schools and colleges, there is growing up a generation of young farmers who are becoming acquainted with these and other signs which are being discovered and recorded by the State and Federal departments of agriculture.

UNFAMILIARITY WITH WEEVIL SIGNS GENERAL.

Experience is a good teacher. It teaches us many things that we do not understand. Many growers of beans and peas have learned from experience that their crops become weevilly after they have been placed in storage. They have lost so many crops that they have been forced either to abandon bean and pea culture or to treat their seeds to kill the weevils. Literally thousands of samples of beans and peas are sent annually to the Department of Agriculture from all parts of the United States with the same monotonous story: "I am greatly worried about my beans. Last year I grew as fine lot of beans as you ever saw and put them away in a pail so nothing could get to them. Imagine my surprise on opening the pail this spring to find them full of bugs and eaten full of holes."

The broker often writes: "Several months ago I purchased a carload of black-eyed cowpeas that seemed to be in A No. 1 condition, but weevils are now developing in them. Where did the weevils come from?"

The representative of a railroad claims department wrote: "Last May we received a consignment of cowpeas at _____, which arrived at destination one month later at _____. The consignee refused to accept the shipment because it was weevilly. The consignor is now suing this railroad for negligent handling of the cowpeas, stating that they were free from weevils when delivered to the railroad. What information has the department that bears upon this subject?"

The gardener, the broker, and the railroad claims agent could have known in advance whether weevils would develop had they watched and recognized the weevil signs that Nature makes plain.

LACK OF KNOWLEDGE LEADS TO FICTION.

In talking once with a buyer of beans in a foreign land the writer inquired if he had had experience with weevils. "Oh, yes," he replied, "I buy beans from many farms. Sometimes they are very weevilly; sometimes the beans from certain farms are very bad, while those from other farms are not weevilly. I think it is all in the weather. If it is rainy, foggy, and warm the weevils are apt to be bad. The weevils come in the fog and rain. Don't you think so?" He knew the weather conditions that favored weevil increase in that country, but no statement of fact could make him believe that the weevils did not "come from the air."

But the most common belief is that weevils develop "from the germ" of the seed or by "spontaneous generation." These false beliefs have grown out of the fact that the round weevil holes come in beans and peas that previously had appeared perfectly sound. How could a weevil eat his way out of a sound bean, leaving behind a large round hole, if he did not develop "from the germ" or "spontaneously" within? Otherwise, how did he get into the bean in the first place?

Right here is where nearly all who handle beans make a mistake. They never see the hole by which the weevil enters. They do not realize that bean weevils, like animals, grow; that they enter beans and peas when they are young and leave when they are fully grown. It is common sense that they enter by a minute hole and leave by a large one.

LIFE CYCLE OF BEAN WEEVILS.

We speak of the life of a man, meaning his existence from birth to death. Every farmer boy learns early that the robin begins life as an egg, later hatches into a helpless, featherless birdling in the nest, and becomes full grown and able to fly only after it has been fed by its parents for some time. More people every year understand that the silkworm moth comes from a silken cocoon made by a worm that hatched from an egg laid by a mother moth. Just because the silkworm moth in becoming adult is first an egg, then a worm, and later a chrysalis or pupa in a protected silken cocoon, we speak of its life as a "life cycle" because each generation goes through the same round of life from egg to adult.

Bean weevils have their life cycles also. Each weevil passes through the egg, worm or larva, and pupa or chrysalis stages before it is fully grown or adult. But the worm or grub of the bean weevil does not crawl about like the ordinary caterpillar, neither does it feed on mulberry leaves as does the silkworm. But it burrows into beans and peas and eats out their substance like a cancer hidden from sight in the human body. It has jaws with which it gnaws out a cavity as it eats the seed tissues. When it becomes as large as it is its nature to become, it turns into a pupa or chrysalis. But instead of making a silken cocoon like the silkworm, it makes a frail cocoon or cell out of the chewed-up parts of the bean seed right in the cavity where it has been feeding. After it has remained a time in the pupal stage it transforms to the male or female adult. The adult weevil eats its way out from cocoon and seed, leaving behind the round hole in the seed so familiar to all bean growers.

LIFE CYCLE SHOWN IN PICTURES.

The life cycle of the bean weevil may be traced in the illustrations of Plate XLI. In figure 1 is shown the weevil eggshell resting where it was laid by the mother weevil on the bean. It is the small white object on the skin on the upper left-hand side. When the weevil grub, or worm, is ready to hatch from the egg, it eats a hole in the side of the eggshell next to the skin of the bean, and then burrows straight through into the bean and down into the pulp of the bean. The empty eggshell remains still attached to the skin of the bean; if it be rubbed off, the tiny hole by which the weevil entered the seed can be seen, although it may be so small that a microscope must be used. For a short distance the grub burrows, making a tiny streak no larger than a pin prick. Notice that the weevil grub comes from the egg and not from the germ of the bean. The germ is shown at *a* in figure 1, and may be also seen in figures 2 to 6, which represent the bean split to show the inside of one of the cotyledons.

As the grub continues to feed in the bean it eats out a larger and larger cavity, as shown by the illustration in figures 2, 3, and 4. By the time the grub has grown to be as large as the one shown in the cavity of figure 4 it has reached full growth. It then makes the cocoon and turns

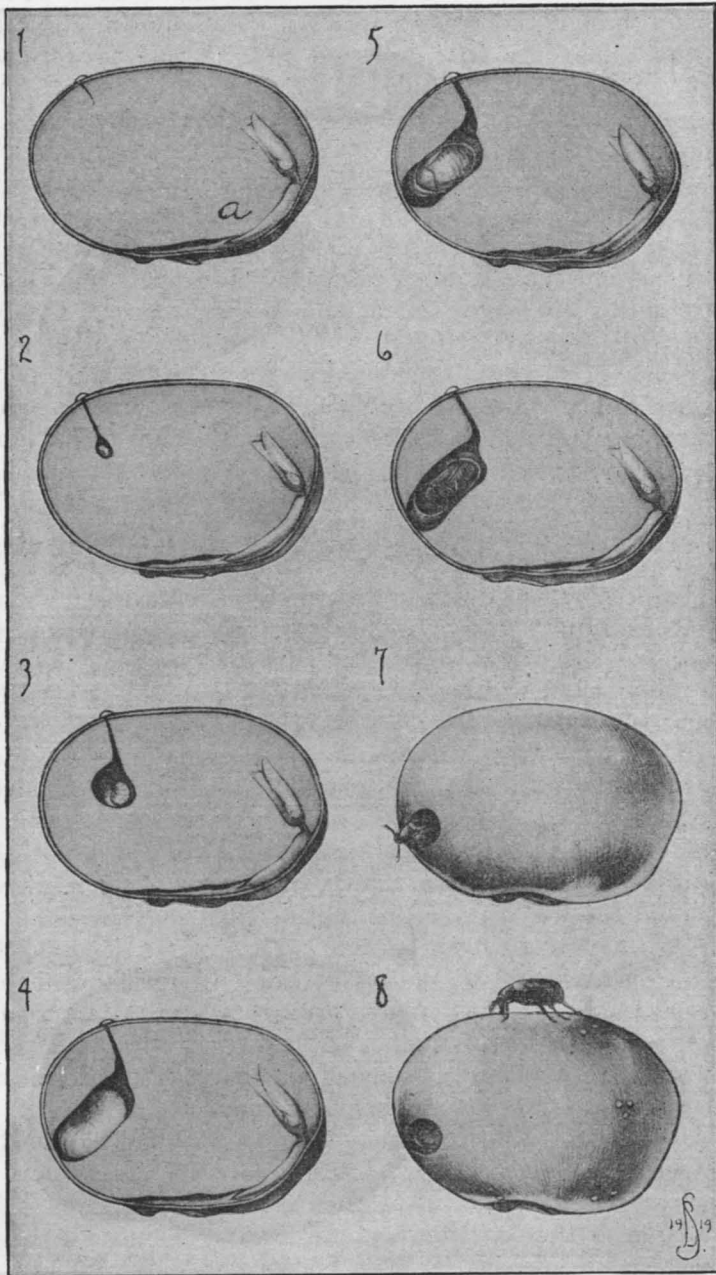

LIFE CYCLE OF A WEEVIL IN A BEAN.

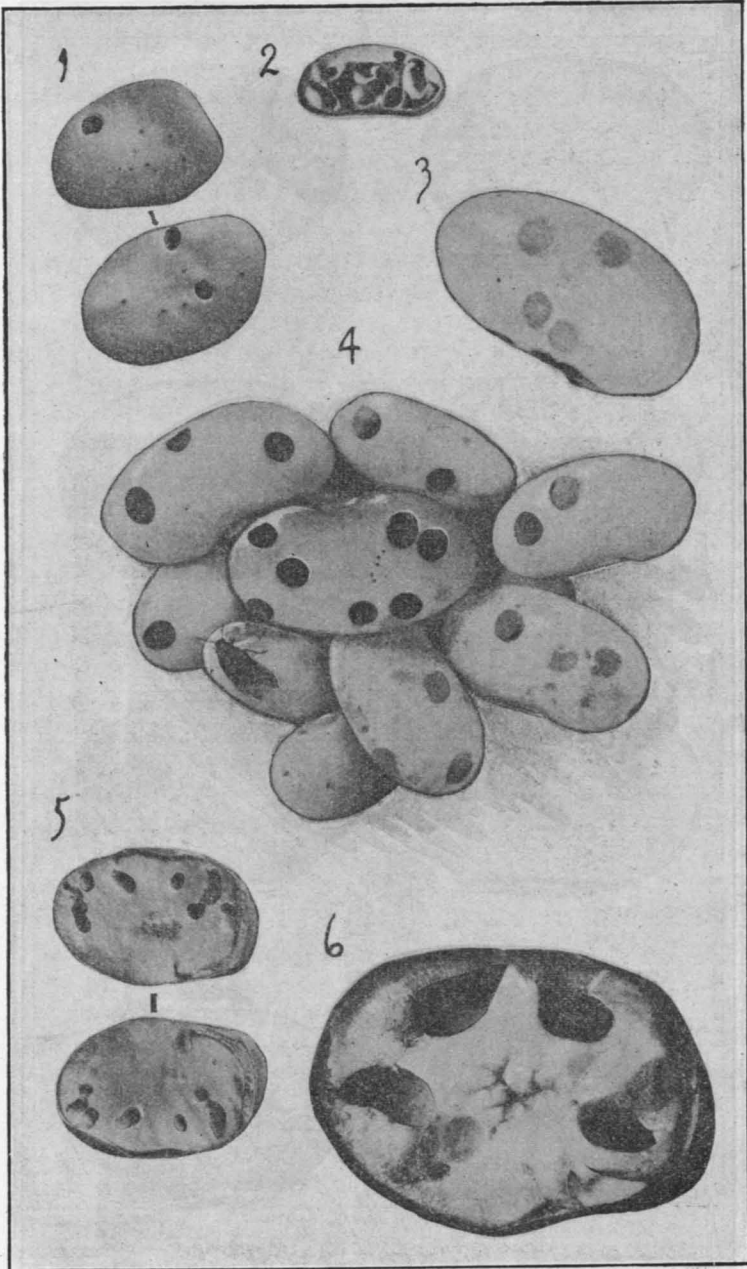

BROAD AND NAVY BEANS INFESTED WITH WEEVILS.

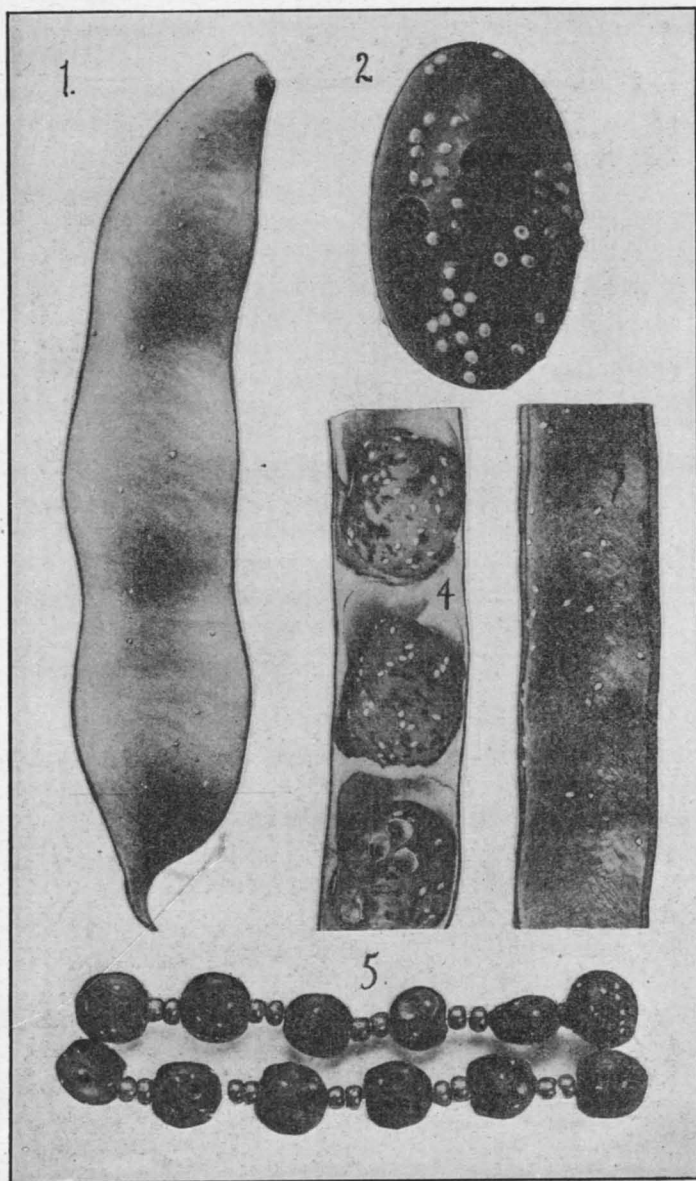

WEEVIL-INFESTED BEANS AND COWPEAS.

into the pupal stage as stated above. In figures 5 and 6 may be seen the cocoon cut open to show the pupa (in fig. 5) and the adult weevil (in fig. 6). Often the adult weevil remains a long time quietly waiting in the cocoon until conditions are favorable outside, and many even die still in the cocoon. But the more active ones eat their way out. In doing this they cut the round openings in the seeds, the appearance of which is the first evidence to most people who can not read weevil signs that their beans are being destroyed. In figure 7 can be seen the weevil crawling out from the seed after cutting out the round opening in the skin. In figure 8 is shown, on the left side, the emergence hole and within it the edge of the cocoon, while on top of the bean is a female weevil laying her tenth egg on the bean. The eggs are laid here and there without attention to any definite pattern and sometimes even loosely among the seeds. The grubs hatching from the eggs laid on the bean of figure 8 will hatch and eat into the bean, and grow just as did the grub hatching from the egg shown in figure 1. They belong to the next generation. And so generation after generation or life cycle after life cycle follow each other.

WEEVIL SIGNS IN THE FIELD.

The parent weevils (shown in figs. 7 and 8, Pl. XLI, and in fig. 4, Pl. XLII) are not often seen in the field, because they are very small and fly or drop to the ground when disturbed. They are scarcely one-quarter of an inch long. But the eggs they lay can be found on the maturing green pods. The eggs appear as mere white specks, as shown about natural size on the green pod of the broad bean (fig. 1, Pl. XLIII), or about twice the normal size on the cowpea pod (fig. 3, Pl. XLIII). An examination of the ripening pods of a crop will give an idea as to the relative abundance or absence of weevils. If many eggs are seen on the pods in the field, plans must be made for a campaign against weevils when the seeds are harvested and put in storage. (Write for Farmers' Bulletin 983 for control measures.)

NO WEEVIL EGGS ON FRESHLY HARVESTED SEEDS.

When the weevil eggs laid in the field upon the pods hatch the young grubs burrow through the pod into the bean. When the eggs are laid on the bean in storage, as shown in

figure 1, Plate XLI, or figures 2 and 4, Plate XLIII, the shell sticks to the bean and is easily seen. But eggs laid in the field on the pods are exposed to the weather, and the eggshells are either washed off by rains or are thrown away with the pods when the crop is harvested. So the beans, just after they are shelled or thrashed, have no weevil eggs upon them. But even then the presence of weevils within can be detected by the presence of the minute hole in the skin of the seed made by the grub after it has burrowed through the pod and into the seed. In figure 1, Plate XLII, are shown 10 such entrance holes and 1 large emergence hole in the upper broad bean, while in the lower bean are 6 entrance and 2 emergence holes. In the center navy bean of figure 4, Plate LXII, can be seen 5 entrance holes close to each other arranged in an irregular line; compare their size with the 7 emergence holes in the same bean. When one learns to look for these entrance holes there is little difficulty in detecting weevil infestation. Of course, these entrance holes are so very small that a person with poor eyes or one not looking for weevil signs will pass them unnoticed and purchase a consignment of seeds as sound because they appear outwardly sound, only later to find them weevilly. The numbers of entrance and emergence holes do not usually correspond, because some of the entrance holes seem to heal over after they have been made, and quite a percentage of the young grubs entering die while they are very small.

EGGS ON SEEDS IN STORAGE SIGN OF WEEVILS.

When a bean broker in Havana receives a consignment of beans or peas he samples carefully the various sacks with the aid of a grain trier. If he finds a single weevil egg (such as those shown about twice normal size on the Whip-poorwill cowpeas of fig. 4, of Pl. XLIII) he says to himself: "There are weevils in this lot of seeds. I shall have to sell them soon or take a loss." Experience in a warm climate where bean weevils multiply fast has taught him to *look for weevil signs in the eggs attached to the seeds*, and with true business acumen he makes the consignor knock off something from the price to cover costs of fumigation or a loss due to immediate or early sale. Weevil eggs on dried seeds are laid by the generations of adult weevils following the generation

laying eggs in the field. If weevilly beans and peas are placed in storage and the weevils not killed, the adult weevils emerge and lay eggs in storage on the dried beans.¹ These eggs are so easily seen that one has only to look to see them.

COMMON BEAN WEEVILS RARELY LAY EGGS ON SEEDS.

In handling navy beans grown in more northern States, one can not depend upon the presence of eggs upon the beans to reveal infestation. This is true because the common bean weevil in storehouses lays its eggs loosely among the seeds, and rarely attaches them to the seed as do the common cowpea weevils. For this reason gardeners and brokers handling navy beans infested by the common bean weevil must look for the entrance holes and not for the eggs. Small as these are, they are large enough to be seen by the knowing eye.

ATTENTION TO WEEVIL SIGNS PREVENTS LOSS.

And so it happens that the signs by which weevils reveal their presence in beans, peas, cowpeas, broad beans, lentils, etc., can be easily seen by anyone who watches. The gardener in caring for his garden during the summer has only to examine carefully the ripening pods on his bean and pea vines to learn whether weevils are present in his garden. It does not take much time as he rests from his labors, and he has the satisfaction of knowing a new secret of nature, besides sparing himself the painful surprise of finding later in his house a ruined weevil-eaten lot of seeds. The newly harvested crop can be examined by the owner or prospective buyer for the presence of the tiny entrance holes which spell disaster later on. And the eggs on the dried seeds and the emergence holes are there for the information of the shrewd conservationist, the broker, or the railroad freight agent. If they can and will read these weevil signs, much of the enormous loss now taking place will be prevented. How to act upon reading weevil signs, and more general information regarding the differing habits of the different kinds of weevils, are discussed in Farmers' Bulletin 983, which can be had free of cost by writing to the Department of Agriculture, Washington, D. C..

¹ This is true except in the case of the broad or horse bean weevil, the lentil weevil, and the common pea weevil. These do not breed in dried seeds. See Farmers' Bulletin 983 for details.

DESCRIPTION OF PLATES.

PLATE XLI. *Life cycle of a weevil in a bean*—Note that in figures 1 to 6 the bean has been split to show the "germ" at *a*. The development of the weevil is shown as follows: In figure 1, a weevil egg has been laid on the upper left side of the bean and the young weevil grub in hatching has gnawed through the eggshell and is tunneling down into the seed, making a hole no larger than a pin prick; in figures 2 and 3, the grub is eating out a larger and larger cavity in the seed as it grows; in figure 4, the grub has become full grown and has eaten the bean substance out to the very skin of the bean; in figure 5, the grub has made a cocoon and has transformed to the pupa; in figure 6, within the same cocoon, the pupa has transformed to the parent weevil; in figure 7, the adult weevil has eaten its way out from the cocoon, has gnawed a round hole in the skin over the cocoon, and is shown crawling out of the bean; figure 8 shows the emergence hole with the rounded edge of the cocoon beneath, and a female weevil laying an egg. Note that she has laid 10 eggs. These will hatch as did the egg of figure 1, and begin new life cycles.

PLATE XLII. *Broad and navy beans infested with weevils*.—Figure 1, two broad or horse beans showing the speck-like entrance holes of the young broad-bean weevil grubs, and the larger emergence holes made by the escaping adults. Figure 2, a badly infested navy bean cut to show cocoons made by common bean weevils. Figure 3, an enlarged bean showing the darkened spots in the skin where four weevils will emerge. Figure 4, a group of common navy beans enlarged to show an adult bean weevil at the lower left, emergence holes, and on the central bean five entrance holes made by young grubs. These five holes appear in the illustration as mere black specks no larger than a pin prick. Figure 5, broad bean cut open to show damage by broad-bean weevil. Figure 6, a broad bean cut open and greatly enlarged to show weevil damage.

PLATE XLIII. *Weevil-infested beans and cowpeas*.—Figure 1, green pod of the broad or horse bean showing, about natural size, the white, speck-like eggs of the broad-bean weevil (Campbell). Figure 2, a cowpea greatly enlarged to show the relative size between the white eggs of a cowpea weevil and the emergence hole made by the adult weevil. Figure 3, a portion of the pod of a Whippoorwill cowpea, about twice natural size, to show the white eggs laid on it by a cowpea weevil. Figure 4, Whippoorwill cowpeas in a dried pod bearing many eggs of a cowpea weevil. Figure 5, portion of a necklace of cowpea seed worn by a Malayan princess and seized by quarantine officers of the Federal Horticultural Board. Note eggs and emergence holes of weevils in the seeds.

THE FARMER AND FEDERAL GRAIN SUPERVISION.

By RALPH H. BROWN,
Grain Supervisor, Bureau of Markets.

HOW does Federal Grain Supervision affect the farmer? The answer to this question should be of interest to every grower of grain in the United States. A knowledge of the essential features of the official grain standards of the United States for wheat, shelled corn, and oats will enable the farmer to know, when his grain is being graded at the country mill or elevator, that it is being done properly. The advantages of grain grading at country points according to the Federal standards, as well as the grading at large markets, under Federal supervision, perhaps may be illustrated best by the following "Story of a Load of Wheat." "Mr. Farmer," "Mr. Elevator Man," "Mr. Broker," and other characters are representative of hundreds more through whose hands grain passes in the various processes of marketing on its way from the fields where it is grown to the manufacturer or consumer.

THE STORY OF A LOAD OF WHEAT.

Mr. Farmer has premium wheat because he carefully selects and treats his seed before planting and also cleans his wheat before he hauls it to market. He rotates his crops and cares for his land so as to have the minimum of weed seeds and foreign material in his grain when thrashed. His thrasher receives orders to clean the wheat thoroughly when thrashing, for Mr. Farmer knows that wheat which is carelessly thrashed will contain foreign material, such as chaff, straw, dirt, and finely broken kernels of wheat, which is considered as "dockage" when the wheat is graded according to the Federal standards. He believes that much of the foreign material which is ordinarily cleaned out of the wheat at the elevator and which is known as "dockage" under the Federal standards is profitable to him for feed on the farm.

After the wheat is thrashed, Mr. Farmer has it either hauled to the elevator immediately or stored in the farm granary. If he stores his wheat on the farm he watches the newspaper quotations of market prices to decide when he will sell, and when the "price of wheat is right to him" he hauls it to the local elevator, where he knows the grade of his high quality wheat will be determined accurately. Mr. Farmer knows the essential features of the Federal grades, for he has read the bulletins describing them, issued by the Bureau of Markets of the Department of Agriculture at Washington; he has visited the office of Federal grain supervision in his district and has learned from the Federal grain supervisor there how the grades are applied; and he has seen the department's grain grading exhibit at the State fair last summer. (See Pl. XLIV.)

PROPER GRADING ASSURES PREMIUM GRADE FOR PREMIUM WHEAT.

Mr. Farmer has already decided to sell to the elevator where his grain is graded rather than the one where it is not graded and where the manager purchases the wheat in the neighborhood on the average of the crop, for he knows that he has raised premium wheat and he wants a premium grade for his product. Where the grain is purchased on the average of the crop, he receives no premium for his wheat over that raised and marketed in a more careless manner.

When the wheat arrives, Mr. Elevator Man proceeds to secure a sample of the load, taking parts of the sample from various parts of the grain, in order to make sure that the sample is representative of the whole load. Mr. Elevator Man has learned from the Department of Agriculture that a representative sample is necessary for obtaining the true grade according to the Federal standards. The sample is taken in a cloth sack into the elevator office and the wheat is screened with the approved sieves to determine if there is any dockage to be assessed. (Pl. XLV, fig. 2.) Mr. Elevator Man finds that there is less than 1 per cent of separated foreign material, and therefore under the Federal standards no dockage is assessed. Mr. Farmer receives full value for his wheat, both as to the weight and the grade, because of this fact. He knew that he was safe in this regard because he had exercised great care in raising his wheat and preparing it for market.

Mr. Elevator Man then makes the test weight per bushel on the dockage-free sample. He fills the test kettle by means of the hopper prescribed by the Department of Agriculture. Mr. Farmer knows that filling the test kettle by means of a hopper will secure more uniform and accurate results than are possible when the test kettle is filled from a bag or pan by hand or by scooping the kettle in the grain, as is sometimes done. He also knows that by filling the kettle in this mechanical way his test will be on the same basis as his neighbors'. The wheat tests $60\frac{1}{2}$ pounds per bushel.

Mr. Elevator Man knows that the wheat is dry enough to grade No. 1 numerically, but since Mr. Farmer wants to know how much moisture is actually in his wheat this year, he weighs out 100 grams and places it in the moisture-testing flask, covers it with oil, places the flask in the tester and applies the heat by means of an alcohol burner. (Pl. XLVI).

While the moisture test is being made, Mr. Elevator Man finishes grading the wheat. There are no damaged grains in Mr. Farmer's wheat, but a few grains of rye and chess seeds (cheat) still remain in the sample. Mr. Elevator Man knows that the foreign material which is not separated in screening the wheat for the dockage is classified as "foreign material other than dockage" under the Federal grades, and is a factor in the grading of the wheat. Therefore, he mixes the sample thoroughly, takes a small portion of it and separates and weighs the rye, which is known as "cereal grains," and the chess seeds, which are known as "matter other than cereal grains." Altogether the rye and the chess amount to nearly 1 per cent, half of which is chess. Mr. Elevator Man knows that a larger percentage of cereal grains is allowed in each grade than of weed seeds and other objectionable foreign matter, because the Federal grades are based on the milling value of wheat and the cereal grains do not affect this value as seriously as do the objectionable weed seeds. He looks at the tabulated form of the Federal grades tacked on the wall over his desk (see page 345) and sees that the No. 1 grade allows 1 per cent of "foreign material other than dockage," half of which may be "matter other than cereal grains" (weed

seeds, etc.), so Mr. Farmer's wheat grades numerically No. 1. Mr. Farmer has ample evidence that the grading is correct and that Mr. Elevator Man wants to be fair with all his farmer patrons, since all the tests are made according to the Federal standards (grades), and the wheat is purchased in accordance with these standards. Since he has seen the newspaper quotations for No. 1 wheat at the terminal markets, he is satisfied that Mr. Elevator Man's price is "in line."

GRAIN SOLD ON BASIS OF SAMPLE INSPECTION.

While the moisture test is being made, Mr. Elevator Man tells Mr. Farmer that his neighbor was in last week to sell his wheat, which had been left in the shock so long that it had been rained on and contained sprouted and other damaged grains. Mr. Elevator Man says that he graded it No. 3 Red Winter, because the dockage-free wheat contained nearly 6 per cent of damaged kernels. The neighbor refused the No. 3 grade and Mr. Elevator Man said he told him that he would take the wheat into his elevator and they would agree on a representative average sample, taking parts from each load, and he would mail the sample to a licensed grain inspector in another State; the grade of the sample would then determine the basis for settlement. Mr. Elevator Man said that after a sample had been taken from each wagon load as it came into the elevator, the grain was thoroughly mixed and divided until the average sample amounted to approximately 2 quarts in size. He placed about half of it in a clean, air-tight can and put the can, together with the remainder of the average sample, into a clean cloth sack, which he mailed to the inspector.

Mr. Elevator Man then wrote the inspector a letter, requesting him to telegraph the grade assigned, and he was very much surprised to receive a telegram the next day saying that the sample had been graded No. 4 Red Winter. Mr. Elevator Man immediately telephoned Mr. Neighbor and they both agreed to appeal the grade to the Federal grain supervisor in the market where the inspector was located. Mr. Elevator Man therefore telegraphed the supervisor accordingly and the supervisor issued a grade memorandum showing the grade of the sample to be No. 3 Red Winter on account of 6.5 per cent of damaged kernels. So Mr. Elevator

Man made a settlement with Mr. Neighbor on the basis of the grade assigned by the Federal grain supervisor. Since no charge is made by the Department of Agriculture when the inspector's grade is changed in an appeal, the only expense was that of the sample inspection fee. Mr. Elevator Man says he was glad to have gone to this extra expense, for Mr. Neighbor was one of his best patrons, and to have the grade assigned by some disinterested party was particularly desirable when the parties interested could not agree on the grade.

Before they finish talking, the moisture test on Mr. Farmer's wheat is complete. The test shows that the wheat contains 13 per cent of moisture. The grade of No. 1 Red Winter allows 13.5 per cent of moisture. In the busy season, Mr. Elevator Man does not apply as much of the tests for grading each load as he has done in this case. During the rush immediately after harvest he generally makes one or two moisture tests to determine the approximate amount of moisture in the wheat in his locality for that crop and at that time, and makes further tests only for the factors which in his opinion determine the grade. For example, if the wheat is dry, clean, and otherwise good enough for No. 1 except the weight per bushel, he makes the weight per bushel test to determine the grade. If the wheat is dry and otherwise good enough to grade No. 1 except that the dockage-free sample contains a good percentage of chaff (cheat), he makes the test for the percentage of "foreign material other than dockage" and "matter other than cereal grains" to determine the grade. But in the quiet season he makes as many of the tests for the different factors as he thinks desirable in each case, and thus more accurately applies the standards.

Our wagon load of wheat, after it is weighed, is placed in the bin in the elevator, from which it will be shipped to a terminal market in another State when Mr. Elevator Man has sufficient wheat of equal grade in the bin to make a carload.

When Mr. Elevator Man ships the carload he advises his commission man that he is sending a load of No. 1 Red Winter wheat and that if it does not grade accordingly he wants it appealed to the Federal grain supervisor. When the wheat arrives at the terminal market several days later the grain inspector grades it and issues an "in" certificate

showing a grade of No. 2 Red Winter. Accordingly, Mr. Commission Man, before he sells the wheat and before the time limit of the close of the second business day after inspection expires, notifies the Federal grain supervisor that he has a carload of wheat which has been shipped in interstate commerce and graded by a licensed grain inspector and that he wants to appeal the grade on the instructions of Mr. Country Elevator Man.

Soon thereafter the Department of Agriculture motor truck carries a Federal grain sampler and sampling equipment to the railroad yards to secure a sample of the grain. (Pl. XLV, fig. 1.) A representative sample is brought to the office of Federal grain supervision and tests and analyses are made of the wheat which show it to be No. 1 Red Winter (moisture 13.5 per cent, test weight per bushel 60.5 pounds, 0.5 per cent of rye [cereal grains], 0.5 per cent of chaff [matter other than cereal grains], no damaged kernels, no heat-damaged kernels, and no wheat of other classes). In order to be sure of the correct grade, the Federal grain supervisor makes a complete test for all the grading factors. The grain supervisor issues a grade memorandum for No. 1 Red Winter which supersedes the grain inspector's certificate.

Mr. Terminal Elevator Man who desires to buy the carload of wheat contends, however, that he believes the licensed inspector's grading is really correct and as an interested party to the transaction notifies the local Federal grain supervisor that he objects to his grading, and calls a board appeal. The Federal grain supervisor telegraphs the final Board of Review located at Chicago, which entertains "super-appeals," properly called, from any point in the United States. The supervisor then immediately transmits by mail the sample and all the papers to the Board. The next day the Board receives and reviews the sample and issues the final grade memorandum showing the correct grade to be No. 1 Red Winter. Immediately, however, the Board notifies the local supervisor by telegraph of its findings, and the supervisor transmits this information to the interested parties.

On the basis of the final grade memorandum Mr. Commission Man then sells the wheat to an elevator man in the terminal market. Mr. Terminal Elevator Man places it in a



FEDERAL GRAIN-GRADING BOOTH AT A STATE FAIR.

This is one of the Federal grain-grading demonstrations held at various State and county fairs in the North and Central West during the summer of 1918, to show farmers, grain dealers and millers, county agents, and other persons interested the correct method of applying the Federal grades for wheat and shelled corn. The exhibits included a complete set of grain-grading equipment, samples of various grades, type trays, and publications of the department relating to grain and grain grading.

340-2

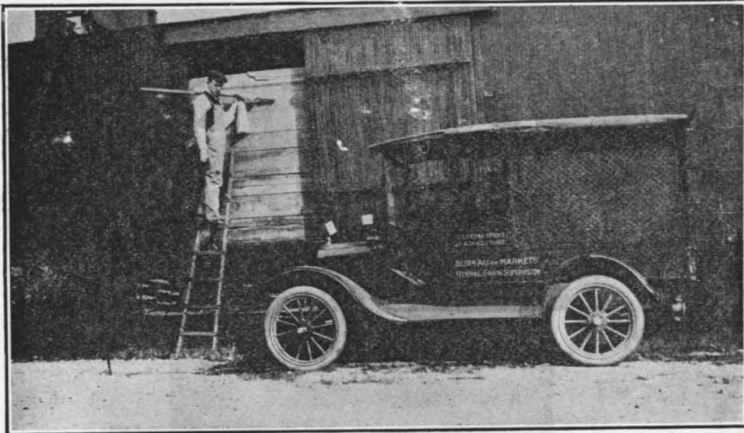

FIG. 1.—FEDERAL GRAIN SAMPLER SECURING A SAMPLE OF GRAIN FROM A CAR.

This Federal grain sampler is about to enter a car to secure a sample of grain. He has with him the sampling cloth, grain trier (probe), and cloth sack for holding the sample. To insure the prompt handling of appeals to the Secretary of Agriculture to determine the true grade of grain, the Department of Agriculture motor truck is used to carry the samplers and sampling equipment directly to the terminal market grain tracks to secure the samples. The method of obtaining a representative sample of grain is described in Department of Agriculture, Office of the Secretary, Circular No. 70.

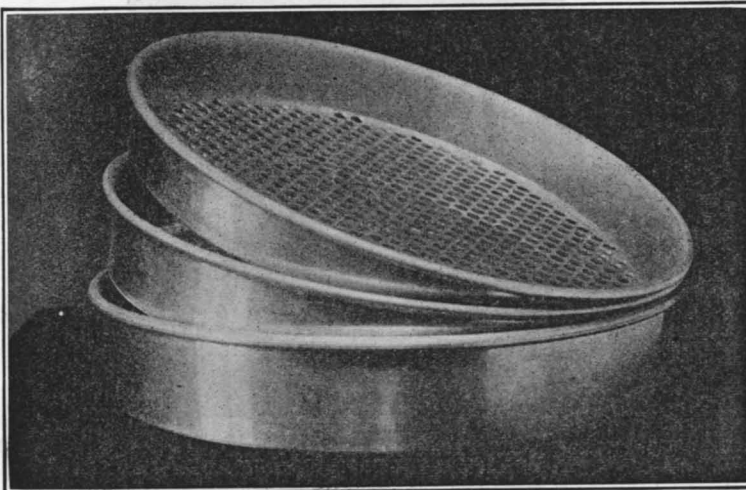
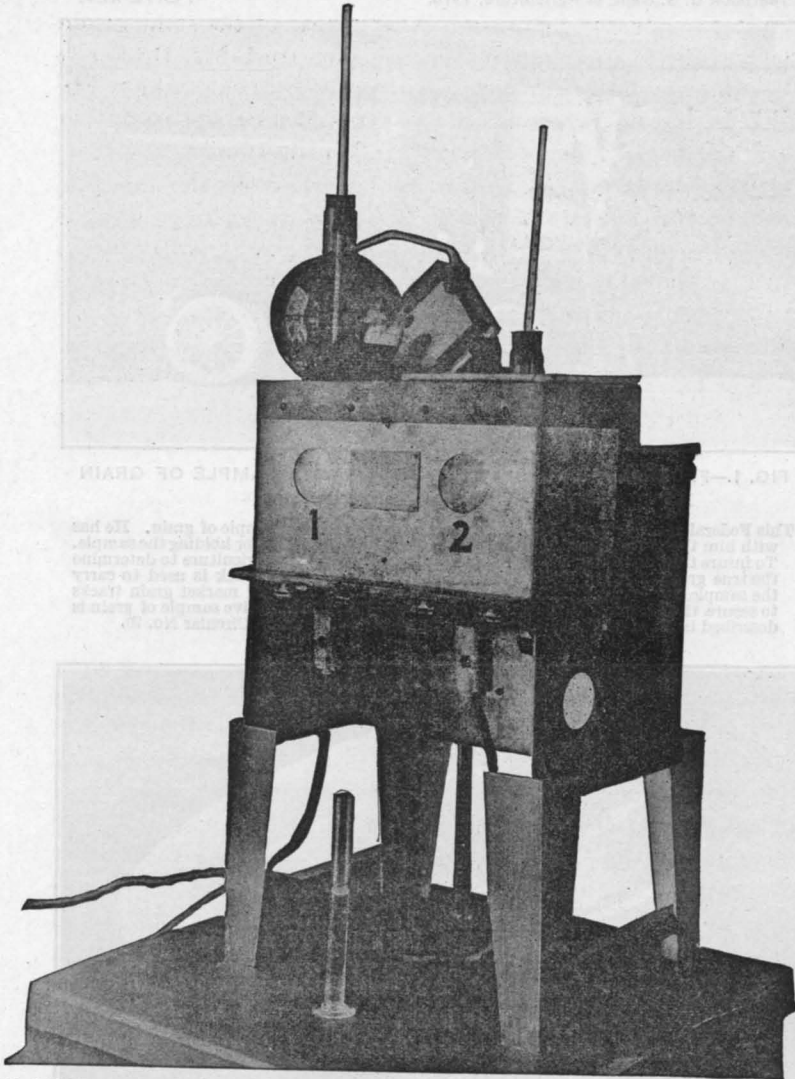

FIG. 2.—NEST OF TWO DOCKAGE SIEVES AND BOTTOM PAN.

Dockage sieves approved by the Department of Agriculture are used for hand-screening samples of wheat for the determination of "dockage" under the Federal standards. A description of the number and kind of sieves, together with the correct method of using them, will be found in U. S. G. S. A. Form No. 90, "Handbook, Official Grain Standards for Wheat and Shelled Corn," issued by the Bureau of Markets of the U. S. Department of Agriculture.



TWO-COMPARTMENT TESTER FOR DETERMINING THE MOISTURE CONTENT OF GRAIN.

The two-compartment machine is adapted for mills and elevators or offices and laboratories where a small number of tests are made at a time. To determine the percentage of moisture under the Federal standards the grain is placed in a glass distillation flask, as shown over compartment 1, and covered with mineral oil. The thermometer, which is held in the flask by means of a rubber stopper, is then placed in the oil so that the bulb is covered. The flask is then connected to a condensing tube which passes through a cooling tank in the rear of the tester. Heat is applied to the flask by means of the electric heater (gas or alcohol burners may also be used) after the flask is placed in the compartment of the tester over a wire gauze. The moisture in the grain rises as vapor in the flask, and passes into the condensing tube, where it is condensed into water. The water drips into the graduated measuring cylinder (cylinder shown standing underneath the machine). When the mixture of grain and oil reaches a certain temperature at which all the moisture has been driven out of the grain, the heat is taken away. As soon as the water stops dripping into the graduated measuring cylinder from the condensing tube, the percentage of moisture is read beneath the thin layer of oil floating upon the water in the cylinder. The test requires about 25 or 30 minutes. The machine is self-computing, the measuring cylinder being graduated to show the actual percentage of moisture. The moisture tester is also built in six-compartment sizes adapted for supervision and inspection offices where a large number of tests are made each day. The machine and the correct method of making the test are fully described in Department of Agriculture Bureau of Plant Industry Bulletin No. 72.



MAP SHOWING LOCATION OF OFFICES OF FEDERAL GRAIN SUPERVISION AND LICENSED GRAIN INSPECTORS.

340-1

98911°-YBK 1918-25 + 26

bin in his elevator containing other wheat of the same grade. Several days later, he receives an order from Mr. Broker in the same market for some Red Winter wheat, which Mr. Interior Miller in another State wants Mr. Broker to buy on terminal market official weights and inspection.

Our load of wheat is run into a car from the bin containing this wheat mixed with other wheat of the same grade; some other wheat containing a good percentage of corn cockle is dribbled in with the wheat that is being loaded on the contract in sufficiently small quantities to keep the percentage of cockle and other objectionable weed seeds (matter other than cereal grains) within the No. 2 grade, so Mr. Elevator Man thinks. The inspector grades the car and issues an "out" certificate showing the grade of the car in which our load of wheat is placed to be No. 2 Red Winter. Mr. Broker gets the samples and examines them very carefully, for he knows that Mr. Interior Miller grinds only a good quality of grain. He examines the sample taken from the car in which our load of wheat was placed and suspects that there is too much cockle mixed in the wheat to grade No. 2, so he appeals, as agent for Mr. Interior Miller, to the Federal grain supervisor. The Federal grain supervisor obtains a sample and determines the grade to be No. 3 Red Winter (test weight per bushel 59.5 pounds, moisture 13.5 per cent, no damaged kernels, no heat-damaged kernels, a trace of cereal grains, 1.5 per cent matter other than cereal grains [which was mostly corn cockle], and no wheat of other classes). The wheat is graded numerically No. 3 because of the 1.5 per cent of "matter other than cereal grains," and Mr. Broker reports to Mr. Terminal Elevator Man that his mill ordinarily will not accept such wheat, but that since there is only one car that does not meet the contract grade, he will accept it at a certain discount from the contract price. Mr. Interior Miller is thus assured of the same quality and condition of wheat purchased on any given grade as Mr. Farmer who originally sold the wheat.

UNIFORM GRADES PLACE ENTIRE GRAIN INDUSTRY ON
UNIFORM BASIS.

Even if an appeal had not been made by one of the interested parties on the grade assigned to the car in which our

load of wheat was placed, a Federal grain supervisor might have secured a supervision sample to check the work of the licensed grain inspector. These Federal grain supervisors, located in the branch offices of the Department of Agriculture in 35 markets in the United States, are at all times checking the work of the various licensed grain inspectors. (Pl. XLVII.) The United States is also divided into 6 divisions with a division supervisor in charge, who observes the grain movement from market to market and adjusts the intermarket inspection discrepancies.

Many of the appeals taken to Federal grain supervisors from the grades assigned by licensed grain inspectors sustain the grade originally placed upon the grain by the licensed inspector. Some variations in the grades are bound to occur at times under any set of standards. In this connection it is important to remember that the sample secured must be representative of the lot of grain from which the sample was taken.

The importance of correct grading of grain at country points had never been called to the attention of farmers and interior dealers, nor had farmers all over the United States manifested such an interest in grain grading previous to the establishment of Federal grades as they have since. Prior to the passage of the United States grain standards Act on August 11, 1916, the grading of grain in some sections of the country was of interest primarily to terminal market grain dealers and millers, or dealers and manufacturers of food products who purchased grain from the terminal markets. Likewise, the country elevator operator or miller in these sections was interested in grain grading only when shipping bulk grain to terminal markets where inspection was maintained. In some sections very little grain grading was done at country points, and country dealers or millers purchased wheat and shelled corn for the most part on the average of the crop in their locality. The result of this practice was that a premium was placed on poor grain and poor methods of farming, while grain of the better quality was discounted, a situation which discouraged good farming methods.

Generally speaking, few tests were applied to the grain purchased from farmers, with the exception of the weight

per bushel test for wheat, and where any grading was done at all the grade was determined on the basis of the judgment of the country buyer, who estimated the approximate grade. Often the difficulty in assigning any specific grade to the grain was that it would be graded differently at different markets, as there was no general uniformity in the grades in effect at the various terminal markets to which the interior dealer shipped. Therefore, the farmer could not determine in his own mind the approximate price he should receive for his grain on the basis of the grade, for not only would the grades be quoted differently at different markets, because of the irregular standards, but the quality and condition of the grain falling, for example, in the No. 1 grade in one market might be entirely different from that falling in the No. 1 grade in another market.

The Federal grades were fixed and established only after the farmers as well as all other persons interested had had an opportunity to be heard in connection with the promulgation of grades. In the fixing of Federal standards the Department of Agriculture desired to harmonize the interests of all concerned. The country grain buyer can now sell to any market on the basis of the same grade and can also purchase his grain from the farmer by the same set of standards by which he sells it in the terminal market.

APPLYING FEDERAL GRADES AT COUNTRY POINTS ENCOURAGED.

While the grain standards Act applies only to grain for which Federal standards have been fixed and which is sold, offered for sale, or consigned for sale and shipped or delivered for shipment in interstate commerce by grade, State inspection departments and grain exchanges throughout the United States have adopted the Federal grades for commerce within the State as well. The department has encouraged the purchase of grain at country points on the basis of Federal grades, so that the farmer may receive a grade proportionate to the quality and condition of his product and be assured a premium grade for premium quality rather than be obliged to sell the grain on the basis of an average of the crop in the locality. The department assists country dealers in applying the standards whenever they request information so that the necessary tests may be made with comparatively inexpensive equipment.

The standardizing of the test is also conducive to the securing of a uniform application of the standards. Farmers, by familiarizing themselves with the grades, can be sure when selling their grain that the standards are being properly applied. Any information in this connection may be had by writing or visiting the nearest office of Federal grain supervision. In case any person desires to check up his determination of the grade of the grain when no licensed grain inspector is located in the community, he can mail a representative sample to the nearest licensed grain inspector and have it officially inspected. This sample should be at least 2 quarts in size, of which at least 1½ pints is placed in an air-tight container and the remainder, if any, in a clean cloth sack. While this grade applies to the sample only, the parties to a transaction involving the sale of grain at country points may agree that the grade of the sample will be applied to the entire lot to be sold, when the sample is determined by both the parties to be representative of the entire lot of grain.

SHELLED CORN STANDARDS TABULATED.

Section 9 of the official grain standards of the United States for shelled corn, tabulated and abridged. (See Note.)

[The numbered footnotes below must be read in connection with the tabulation.]

Grade No.	Minimum test weight per bushel.	Maximum limits of—			
		Moisture.	Foreign material and cracked corn.	Damaged kernels.	
				Total.	Heat damage.
	<i>Pounds.</i>	<i>Per cent.</i>	<i>Per cent.</i>	<i>Per cent.</i>	<i>Per cent.</i>
1.....	55	14.0	2	2	0.0
2.....	53	15.5	3	4	0.1
3.....	51	17.5	4	6	0.3
4.....	49	19.5	5	8	0.5
5.....	47	21.5	6	10	1.0
6.....	44	23.0	7	15	3.0
Sample*.....

**Sample Grade.*—Shall be White corn, or Yellow corn, or Mixed corn, respectively, which does not come within the requirements of any of the grades from No. 1 to No. 6, inclusive, or which has any commercially objectionable foreign odor, or is heating, hot, infested with live weevils or other insects injurious to stored grain, or is otherwise of distinctly low quality.

(1) The corn in grades Nos. 1 to 5, inclusive, shall be cool and sweet.

(2) The corn in grade No. 6 shall be cool but may be musty or sour.

NOTE.—The above tabulation does not constitute in whole the official grain standards of the United States for shelled corn.

WHEAT STANDARDS TABULATED.

Sections 15 to 20, inclusive, of the official grain standards of the United States for wheat, tabulated and abridged. (See Note.)

[The numbered footnotes below must be read in connection with the tabulation.]

Grade No.	Minimum limits of test weight per pushel.			Maximum limits of—						
				Moisture.		Damaged kernels.		Foreign material other than dockage.		Wheats of other classes.
	Class Hard Red Spring.	Classes Durum, Hard Red Winter, Common White, and White Club; and subclass Red Winter.	Sub-class Red Walla.	Classes Hard Red Spring and Durum.	Classes Hard Red Winter, Soft Red Winter, Common White, and White Club.	Total.	Heat damage.	Total.	Matter other than cereal grains.	Total.
	Lbs.	Lbs.	Lbs.	P. ct.	P. ct.	P. ct.	P. ct.	P. ct.	P. ct.	P. ct.
1.....	58	60	58	14.0	13.5	2	0.1	1	0.5	5
2.....	57	58	56	14.5	14.0	4	0.2	2	1.0	10
3.....	55	56	54	15.0	14.5	7	0.5	3	2.0	10
4.....	53	54	52	16.0	15.5	10	1.0	5	3.0	10
5.....	50	51	49	16.0	15.5	15	3.0	7	5.0	10
Sam- ple*	-----	-----	-----	-----	-----	-----	-----	-----	-----	-----

* *Sample Grade.*—Shall be wheat of the appropriate subclass which does not come within the requirements of any of the grades from No. 1 to No. 5, inclusive, or which has any commercially objectionable foreign odor, except of smut, garlic, or wild onions, or is very sour, or is heating, hot, infested with live weevils or other insects injurious to stored grain, or is otherwise of distinctly low quality, or contains small, inseparable stones or cinders.

- (1) The wheat in grade No. 1 shall be bright.
- (2) The wheat in grades Nos. 1 to 4, inclusive, shall be cool and sweet.
- (3) The wheat in grade No. 5 shall be cool, but may be musty or slightly sour.
- (4) The wheat in grade No. 1 Dark Northern Spring and grade No. 1 Northern Spring may contain not more than 5 per centum of the hard red spring wheat variety Humpback.
- (5) The wheat in grade No. 1 Amber Durum and grade No. 1 Durum may contain not more than 5 per centum of the durum wheat variety Red Durum.
- (6) For each of the subclasses of the class Durum, grade No. 1 and grade No. 2 may contain not more than 2 per centum and 5 per centum, respectively, of soft red winter, common white, and white club wheat, either singly or in any combination.
- (7) For each of the subclasses of the classes Hard Red Spring and Hard Red Winter, grade No. 1 and grade No. 2 may contain not more than 2 per centum and 5 per centum, respectively, of common white, white club, and durum wheat, either singly or in any combination.
- (8) For each of the subclasses of the classes Soft Red Winter, Common White, and White Club, grade No. 1 and grade No. 2 may contain not more than 2 per centum and 3 per centum, respectively, of durum wheat.

NOTE.—For grades for Mixed wheat, Treated wheat, Garlicky wheat, and Smutty wheat see sections Nos. 21, 22, 23, and 24, respectively, of the official grain standards of the United States for wheat.

The above tabulation does not constitute in whole the official grain standards of the United States for wheat.

OATS STANDARDS TABULATED.

Section 13 of the official grain standards of the United States for oats, tabulated and abridged, showing the grade requirements for white, red, gray, black, mixed, bleached, and clipped oats. (See Note.)

[The numbered footnotes below must be read in connection with the tabulation.]

Grade.	Condition and general appearance. ¹	Minimum test weight per bushel.	Sound cultivated oats not less than—	Heat damaged (oats or other grains).	Foreign material.	Wild oats.	Other colors, cultivated and wild oats.
		Pounds.	Per cent.	Per cent.	Per cent.	Per cent.	Per cent.
2 ¹	Shall be cool and sweet, and of good color.....	32	98	0.1	2	2	³ 2
2	Shall be cool and sweet, and may be slightly stained.....	29	85	.3	2	3	⁴ 5
3	Shall be cool and sweet, and may be stained or slightly weathered.....	26	90	1	3	5	10
4	Shall be cool, and may be musty, weathered, or badly stained.....	23	80	6	5	10	10
Sample grade.*							

* *Sample grade.*—Shall be white, red, gray, black, mixed, bleached, or clipped oats, respectively, which do not come within the requirements of any of the grades from No. 1 to No. 4, inclusive, or which have any commercially objectionable foreign odor, or are heating, hot, sour, infested with live weevils or other insects injurious to stored grain, or are otherwise of distinctly low quality.

¹ The percentage of moisture in grades Nos. 1, 2, and 3 shall not exceed 14½, and in grade No. 4 shall not exceed 16.

² In the case of white oats, No. 1 shall be cool and sweet and of good white or creamy white color.

³ 4 per cent of other colors allowed in No. 1 red, gray, or black oats. This column does not apply to mixed oats.

⁴ 10 per cent of other colors allowed in No. 2 red, gray, or black oats.

NOTE.—It will be noted that no limits are specifically stated for damage other than heat and for other grains. These are taken care of by the minimum requirements for "sound cultivated oats" in each grade. The following example illustrates the application of the tabulation:

Aside from other requirements, such as condition and general appearance and weight per bushel, a lot of oats, to grade No. 1, must contain 98 per cent "sound cultivated oats." The remaining 2 per cent may be damaged grains, foreign material, other grains or wild oats, either singly or in any combination. The only limitation on this remaining 2 per cent is that not more than one-tenth of 1 per cent may be heat damaged.

The above tabulation does not constitute in whole the official grain standards of the United States for oats.

HOUSING THE WORKER ON THE FARM.

By E. B. McCORMICK,

Chief of Division of Rural Engineering, Bureau of Public Roads.

THE manufacturer who has studied his labor costs knows that the "turn-over" or replacement cost easily may become excessive. One manufacturer has recently stated that he figures it costs him \$80 to replace a man. The manufacturing industry has become so thoroughly impressed with the fact that it is desirable to secure and retain satisfactory employees that no item, however trivial, is overlooked that may lead toward permanency in the force of employees. The manufacturer avoids changes in his working force whenever possible. The farmer has more incentive to retain a permanent force than the manufacturer. Because of the greater distance and of the time involved, it is apparent that the cost of replacing help on the farm necessarily is greater than it is in the city. In addition to the actual outlay of time and money required to secure new men, there is a loss in efficiency due to the time and labor spent in "breaking in" new and possibly "green" hands.

Because of the housing and other conditions that have existed in the past on many farms, it has been necessary for the majority of farmers to rely upon securing unmarried men. This condition need not exist. There is no reason why desirable quarters should not be provided for a man with family; furthermore, there is no reason why living conditions on the farm and in rural communities should not be such that a man who is desirous of securing for his family pleasant surroundings and opportunities for education and development can return to the farm and find the conditions that he most desires.

THE CITY A SOURCE OF FARM LABOR.

One possible source of farm help, and one from which little has been drawn in the past, is the city man who has had farm experience in his youth and is desirous of getting back to the farm, provided he can make the change without at the same time sacrificing most of the comforts and conveniences to which he has been accustomed in his city life.

In attempting to draw men for the farm from the cities, provision must be made for securing the more desirable individuals from the existing supply. In very large cities are thousands of intelligent, skilled workers and mechanics who would welcome an opportunity to move their families to farms if they were assured comfortable living conditions and pleasant surroundings. Even at present, in spite of the seemingly extravagant wages paid for labor, both skilled and unskilled, the cost of housing, feeding, clothing, and educating the family imposes a burden under which many men in the cities are barely able to hold up. To these men the thought has often come, "Why, with the existing demand for farm labor, can I not move my family to the country, and in spite of the lower wages, be better off than where I am?" The answer often is, "I could if I could find pleasant living quarters and educational opportunities for my children."

**PROVIDE CITY COMFORTS AND CONVENIENCES NOW
LACKING ON FARMS.**

No matter how undesirable life in the city may be from certain standpoints, the fact can not be denied that nearly every city dweller is accustomed in his everyday life to many comforts and conveniences that at present are not available on the average farm. Among those to which he is accustomed and which can and should be provided for every farm dweller are good educational facilities for his children, well heated and ventilated dwellings, and sanitary conveniences of various kinds. A large proportion of the city man's income, whether it be salary or wages, is expended for rent, fuel, food, and clothing for himself and family. The first two items can be provided by the farmer at a nominal cost, as can be a large portion of the third. The expense of the fourth will be reduced materially on moving to the country.

If the prospective farm worker can be shown conclusively that pleasant living quarters and conditions are offered to him and an opportunity given to secure his food at a low cost, he will give these points full weight in considering a move to the farm. He knows where his income goes, to a great extent, and will readily forego the high wages now being received, provided he sees that he secures in exchange equal or better living conditions. The longer working day

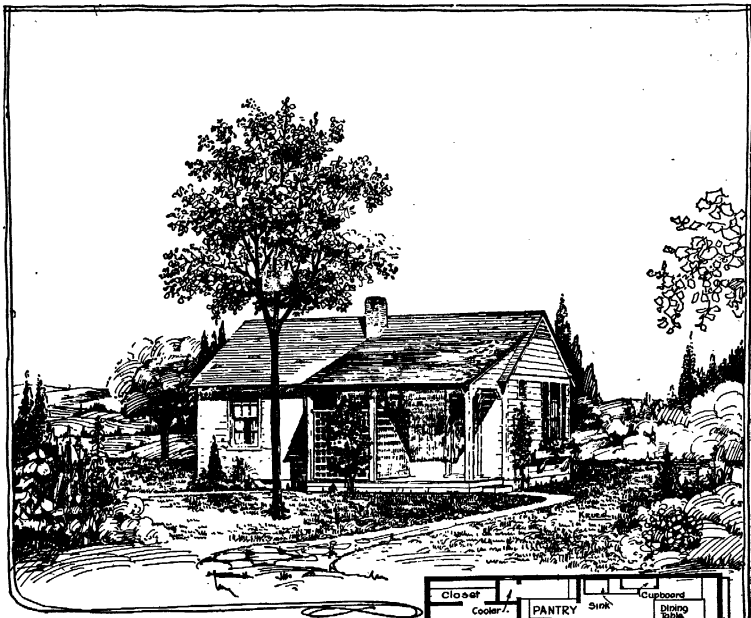
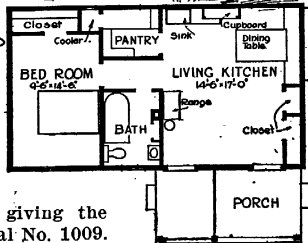

FIG. 17.—A convenient and comfortable cottage for a man and wife with not more than one or two small children. It includes bathroom, range and hot water boiler, sink, and commodious closets and cupboard. By means of a screen partition the porch is divided, giving the effect of a front and rear entrance. Serial No. 1009.



prevailing on the farm need not act as a deterrent, as many city laborers now spend from one to two hours morning and night in going to and from their work, so that a nominal 8-hour day in the city may, in point of time consumed, be equivalent to a 10- or sometimes even a 12-hour day in the country.

In every city, and in fact in every community, are numbers of men who, through lack of educational advantages or because of stress of financial matters in their youth, or because of the lack of initiative and ability to direct the work of others, are satisfied to occupy places as laborers in one or another branch of industry. Many of these men are desirable employees. They are either kept out of, or have gotten out of, places as farm hands, because in the past a job as a "hired man" on a farm has been considered about the lowest

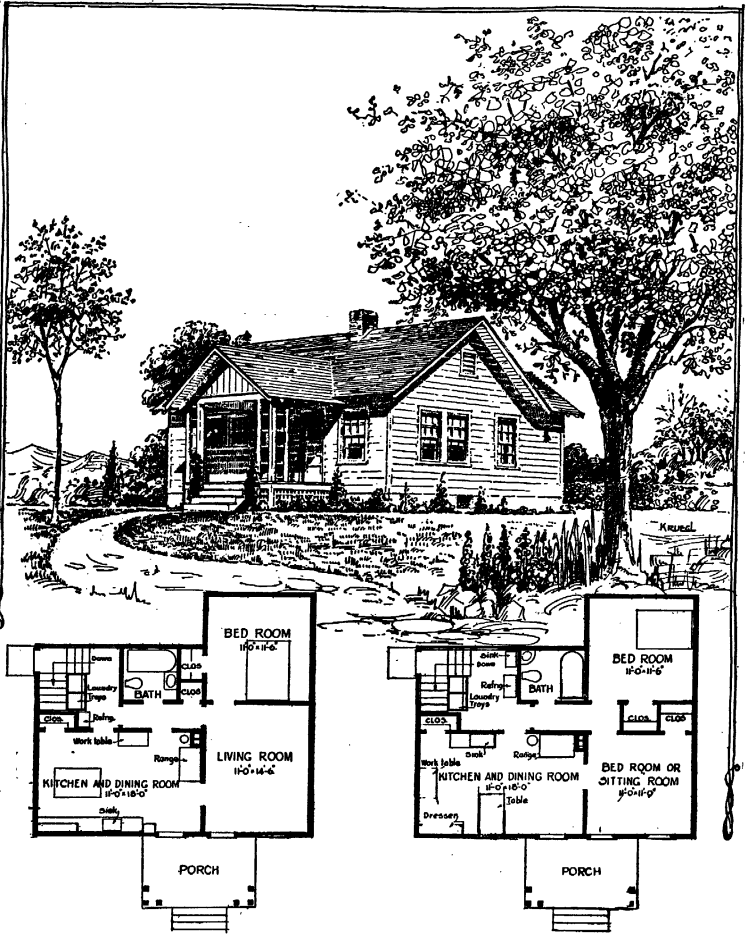

FIG. 18.—A larger cottage with one more room than figure 17. In addition to the bath, range, and sink, it has laundry trays and a refrigerator. It also has a cellar. It will accommodate a man and wife and three or four children. Alternative plans for the interior arrangement are given, either of which may be used. Serial No. 1017.

in the industrial scale. The laborer in the city or town has advantages of education and recreation for his family as well as for himself that previously have not been provided in the country. To provide reasonable and rational means of recreation, educational facilities, and pleasing surroundings in the home will result in securing for the farm men of the most desirable type.

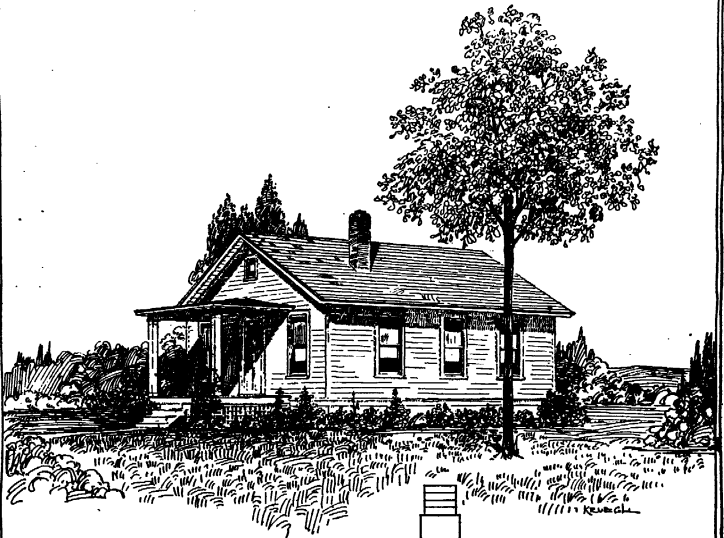
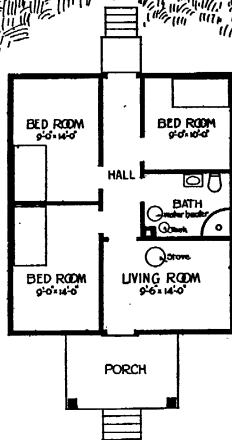

FIG. 19.—Design and plan for a simple, comfortable bunk house for three to six men. It includes a bathroom with water heater, shower bath and toilet, and a living room with stove. Numerous windows give ample light and ventilation. Serial No. 1032.



The conditions to be met for married and for single men, of course, are entirely different. A family should have a house to itself. Single men should be grouped in one or more bunk houses where possible, instead of being placed with families. The family desires and must have the privacy essential to the true home and necessary in the proper upbringing of children. The single man, on the other hand,

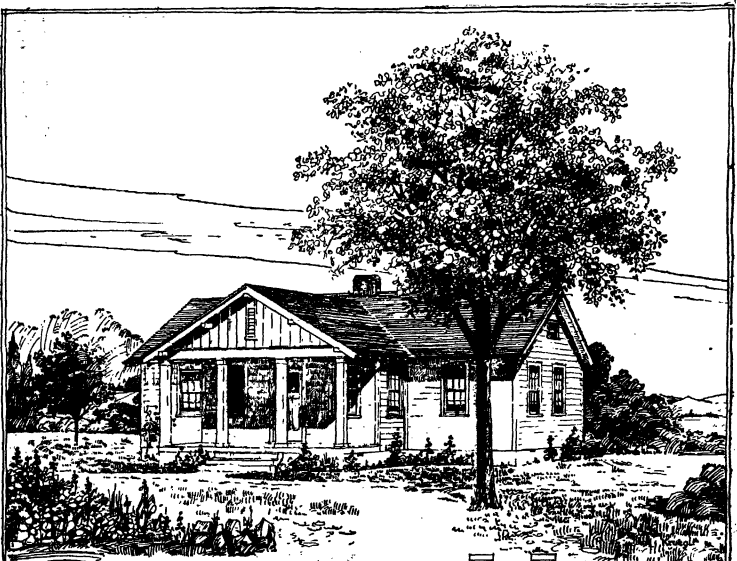
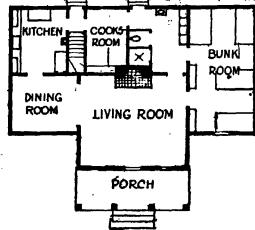

FIG. 20.—A larger bunk house with kitchen and dining room for cooking and serving meals. The bunk room may be enlarged and the cooking and eating quarters converted into sleeping rooms, if meals are not to be served. A fireplace adds to the attractiveness of the living room. Serial No. 1011.



should have a degree of freedom not attainable when he must be a part of another's household.

PLANS OF HOUSES FOR FARM WORKERS.

The illustrations accompanying this article show two designs of family houses and two of bunk houses for unmarried men, also bird's-eye views and plans showing desirable locations and surroundings of the cottages.

Figure 17 shows a small two-room house of simple design suitable for a married man with not to exceed one or two small children. It may be constructed as cheaply as a small box house, and possesses the advantages of a front and back porch under one roof, two entrances, and a pleasing, home-like appearance. Figure 18 shows a somewhat more roomy house, with no features that should be considered superfluous. It will accommodate a family with from two to four chil-

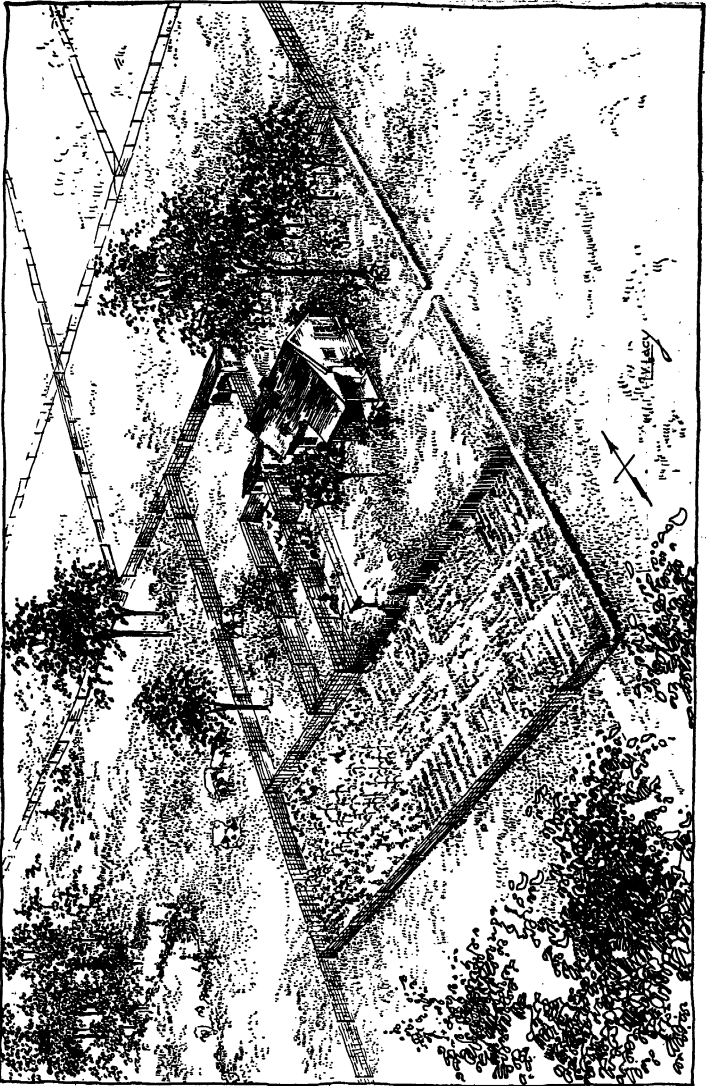

FIG. 21.—This cottage plot contains garden, fruit, and place for cow and poultry. Serial number of cottage, 1009.

dren. Alternate plans are shown, either of which may be used. Figure 19 illustrates a simple bunk house suitable for three to six men. In this case it is assumed that the men will secure their meals at the headquarters house or with the family of a married man. Figure 20 provides for meals to be served in the bunk house itself. This plan is particularly

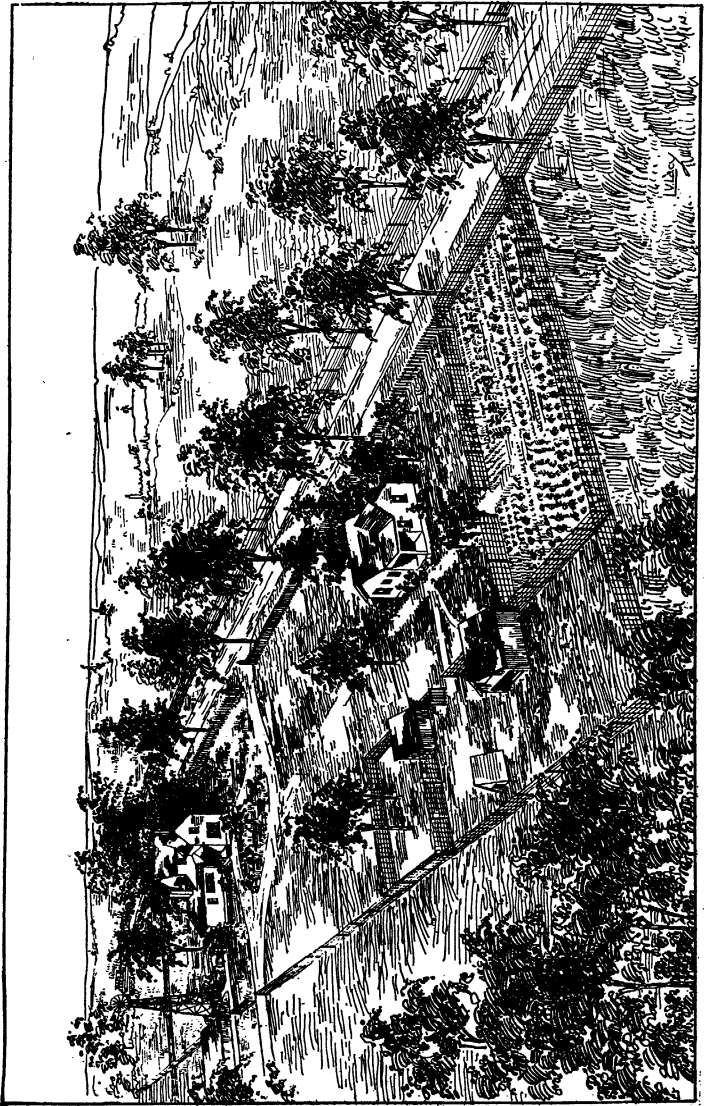

FIG. 22.—Homelike, attractive, and convenient are the grounds and cottage shown here. Serial number of cottage, 1014.

applicable where no married men are employed, and the force is too large to be fed at headquarters. The sleeping room is susceptible of unlimited enlargement. The kitchen and dining wing may be converted into a dormitory if mess facilities are not desired.

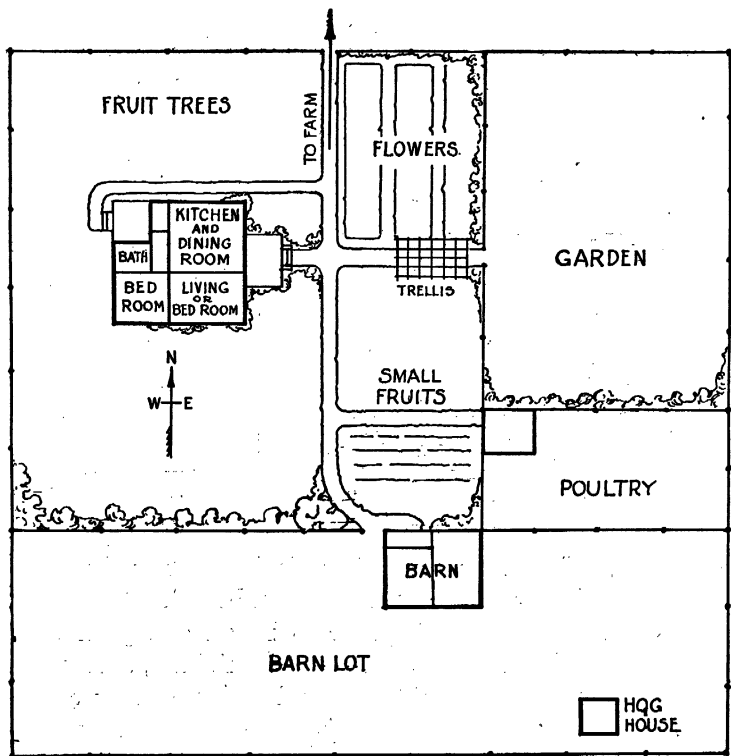

FIG. 23.—Plan for a comfortable cottage and attractive grounds. Ample space is provided for trees and small fruits, garden, flowers, and buildings, besides yards for cow, pigs, and poultry. Serial number of cottage, 1014.

In all the plans shown, bathing facilities are provided. This is an important feature and will do much toward holding help on the farm.

The remaining designs show either bird's-eye views or plots of suitable settings for cottages such as are shown in the preceding plans. Figure 21 shows a view from the southeast, the cottage facing south, the farm headquarters being located east of the cottage. Figure 22 shows a view from the northeast, with the cottage facing south. The headquarters is shown south of the cottage. Provision has been made for a small plot of approximately one-half acre for the individual use of the man and his family. Figure 23 is a plot for the same house shown in figure 22, but giving the house an eastern frontage. In figure 24 the design of cottage shown in figure 18 is used with a western frontage.

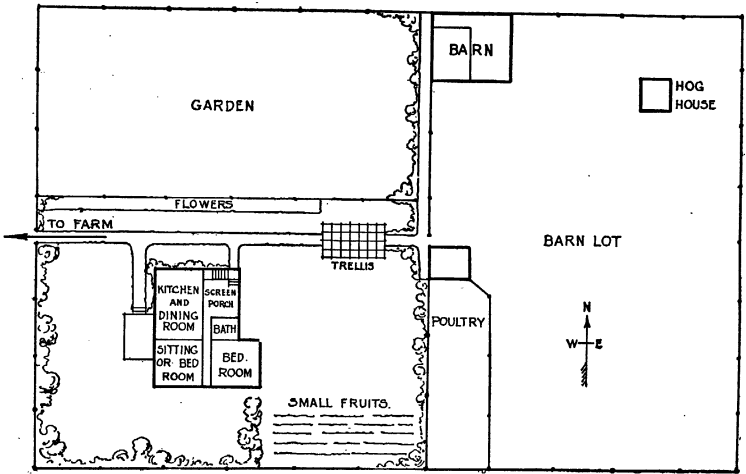

FIG. 24.—This plan includes much the same features as figure 23, but differently arranged. Serial number of cottage, 1017.

It is assumed that the prevailing winds are from the southwest. For this reason outbuildings have been located so that odors from them will not prove to be an annoyance. In each case, provision has been made for chickens, a cow, and a pig, as it is thought that each family should have an opportunity either to own or have the use of them. Room has been provided for small fruits and a garden. The houses and the plots illustrated have been selected from those designed by the Division of Rural Engineering of the Department of Agriculture and full working drawings may be obtained on application.

Information about the water supply for these houses may be obtained from Farmers' Bulletin 941, "Water Systems for Farm Homes." The question of sewage disposal on farms is treated in Yearbook Separate No. 712, copies of which can be obtained by applying to the Division of Publications, Department of Agriculture.

SISAL AND HENEQUEN AS BINDER-TWINE FIBERS.

By H. T. EDWARDS,

*Specialist in Fiber-Plant Production,
Bureau of Plant Industry.*

FOOD SUPPLY OF THE UNITED STATES.

THE production, preparation, and distribution of an abundant food supply for the 100,000,000 consumers in this country, with a surplus for export to other countries, is an exceedingly complex industrial problem. It has been demonstrated during the war that the entire world is never far distant from the "bread line." It is essential, primarily, that food be sufficient for the present day and year, but it is essential also that such foresight be used, and such precautions be taken, as will give reasonable assurance of an abundant food supply for the years to come. The needs of the food-producing organization and the requirements of the food-producing machines must be clearly understood. If any defects exist in the organization, or any reasons why the operation of the machines is liable to interruption, it is desirable that these conditions be remedied with the least possible delay.

The food situation of the United States is materially different from that of certain other countries. In China, for instance, a shortage of rice must inevitably be followed by famine. This country has a great variety of food products in general use, and is not absolutely dependent on any one of these products.

Bread, however, is a staple food that is almost universally used throughout this country, and the maintenance of an abundant supply of bread is the one most important feature of our food problem.

THE GRAIN INDUSTRY.

Half a century ago the small-grain crops—wheat, oats, rye, and barley—were harvested entirely by hand labor. The only implements required were a grain cradle and a

hand rake. The sheaves of grain were bound with bands made from the straw itself. The farmer of that period was independent of the outside world. Hand labor was used in every stage of the operations and production was limited, but the necessary labor was available, and the crops were sufficient to meet the existing demand for food.

The grain producer of to-day is no longer in this independent position. He has become a part of the great food-producing organization. The manufacturers of far-distant cities furnish him machinery; his grain is bound with twine made from fiber that is imported from foreign countries; the jute fields of India provide the material for his grain sacks. With this use of machine methods, the amount of hand labor required is relatively small, and the total production of grain is enormous. It is essential, however, that there be no flaws in the organization, no interruption in the operation of the machines, if our millions are to be fed.

THE PLACE OF BINDER TWINE.

During the year 1917 more than 100,000,000 acres were planted in the United States to the small-grain crops, wheat, oats, barley, rye, and rice. The total production of these crops amounted approximately to two and one-half billions of bushels, the greater part of which was harvested with harvesting machines. These machines not only cut the grain, but also bind it in bundles and automatically tie these bundles with binder twine (Pl. XLVIII, fig. 1). If the operation of the harvesting machines is to be continued, the necessary supply of binder twine must be available. To harvest the present annual grain crop of this country, or even a considerable part of it, with hand labor would be a physical impossibility with the amount of farm labor now available.

Fifty years ago binder twine was unknown. At present 200,000,000 pounds of binder twine are required to bind one year's grain crop in the United States, while more than 100,000,000 pounds of American binder twine are used each year in the grain fields of other countries. With the steadily increasing production of grain in the United States, there will necessarily be a corresponding increase in the consumption of binder twine in this country. With the development of grain production in eastern Europe, Manchuria, Aus-

tralia, Argentina, and other countries, and with the more general use of harvesting machinery in these countries there is sure to be a very material increase in the world's total consumption of binder twine.

Inasmuch as grain production is now dependent on the use of harvesting machines, and as the operation of these machines is dependent on the supply of binder twine, it is evident that the supply and the cost of bread are directly affected by the supply and cost of binder twine. It is equally evident that the binder-twine situation is largely determined by the supply and cost of the materials required for the manufacture of this article.

BINDER-TWINE FIBER.

Practically all binder twine is made of hard fibers. These fibers include henequen from Yucatan and Campeche; sisal from tropical East Africa, the Bahamas, Java, and the Hawaiian Islands; abacá from the Philippine Islands; and phormium from New Zealand. Some of the soft fibers, such as hemp, jute, and flax, have been used to a limited extent, but these fibers appear to be unsatisfactory for binder twine.

Among hard fibers suitable for the manufacture of binder twine, both abacá and phormium occupy a position of very minor importance. The price of abacá fiber is such as to prevent its extensive use for binder twine when cheaper fibers are available. The total production of phormium is not sufficient to make this fiber important.

Henequen and sisal furnish approximately 90 per cent of the raw material now used in the manufacture of binder twine, and approximately 80 per cent of the world's supply of binder twine is made from Yucatan henequen. If for any reason the production of henequen in Yucatan should decrease materially, the results would be disastrous. Failure to set out new plantations so as to keep up production in future years, which is even now reported in Yucatan, must result in a shortage of supply unless plantations are developed elsewhere. In course of time substitutes for this fiber might be obtained, but the immediate results would be a curtailment in the production of grain and a consequent shortage in the world's supply of bread. Furthermore, if any considerable part of the supply of Yucatan henequen

should be diverted to markets other than those of the United States, the American farmer would either be without binder twine or would be dependent for his supply on the manufacturers of other countries.

The cost of binder twine is also worthy of consideration. With an annual consumption of 300,000,000 pounds of binder-twine fiber; an increase in the cost of this fiber of 1 cent per pound is equivalent to a total increase of \$3,000,000. In September, 1915, the price of Yucatan henequen in the New York market was 5½ cents per pound. In August, 1917, the price had advanced to 19½ cents per pound, an increase of 14 cents per pound, or approximately 270 per cent, within a period of less than two years. With the present consumption of binder-twine fiber in this country, this increase in the cost of henequen fiber is equivalent to an increase of more than \$28,000,000 in the yearly binder-twine bill of the American farmer.

At present the production of 80 per cent of the total available world's supply of a raw product that is indispensable to the grain producer of this country is confined to one small foreign state. It is by no means impossible that either natural or political conditions may arise that will result in a material reduction in the supply of Yucatan henequen.

The existing binder-twine fiber situation is not only unsatisfactory, but also exceedingly dangerous. It is one of the weakest spots in the food-producing organization of the United States.

The situation can be remedied either by using substitutes for henequen in the manufacture of binder twine or by increasing the production of henequen and sisal in countries other than Yucatan. The introduction of substitutes would be a difficult and slow undertaking, but there appears to be no satisfactory reason why the production of both henequen and sisal can not be increased very materially in several countries.

GEOGRAPHICAL DISTRIBUTION OF SISAL AND HENEQUEN.

The henequen plant, *Agave fourcroydes*, is native in the Yucatan Peninsula (Pl. XLIX, fig. 1), where it has been cultivated for centuries. During the last 50 years many large henequen plantations have been established in Yucatan.

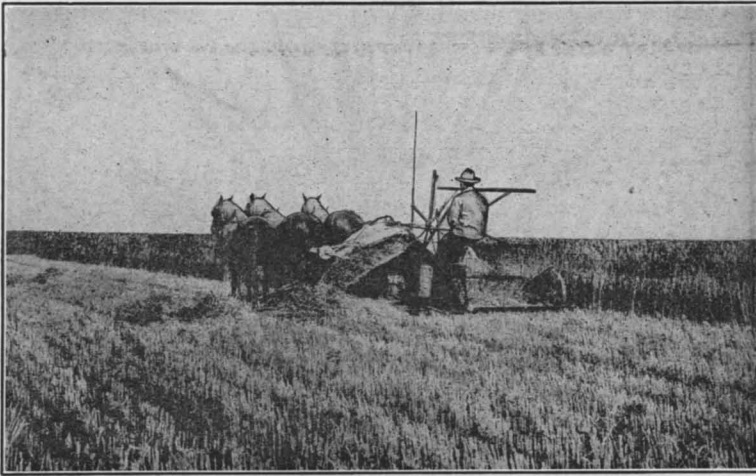

FIG. 1.—SELF-BINDER IN OPERATION.

Grain, cut at the right of the machine, is carried over the elevator to the left, where it is bound in bundles tied with binder twine.

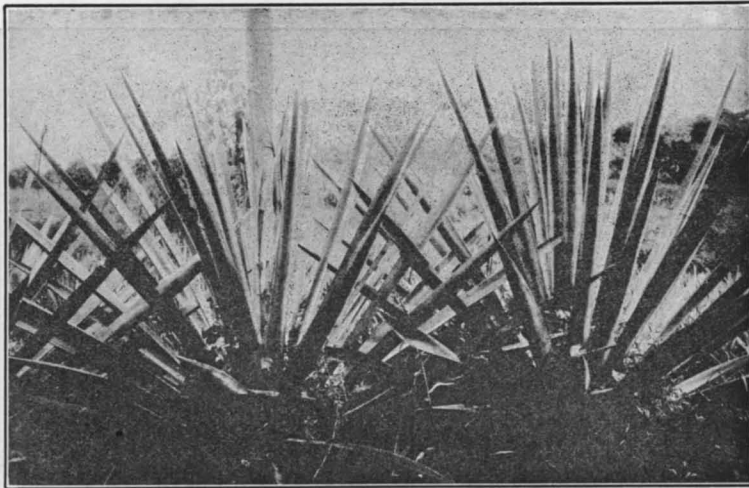

FIG. 2.—SISAL IN PORTO RICO.

Mature plants of the first sisal introduced into Porto Rico from the Bahamas in 1902.

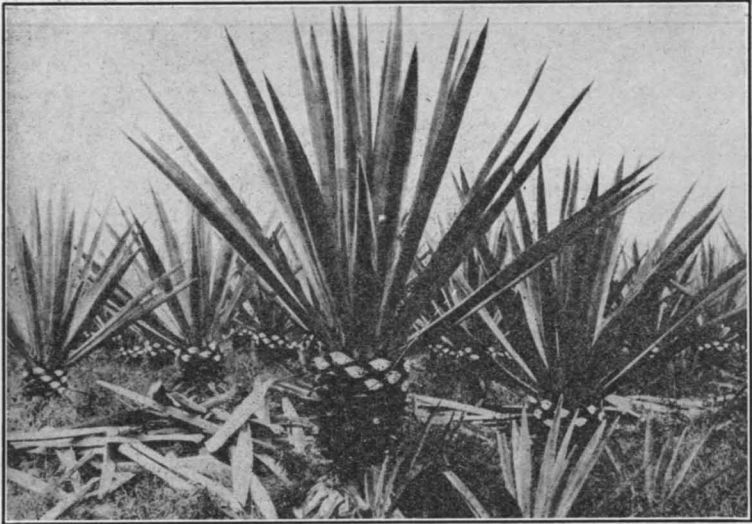

FIG. 1.—HENEQUEN IN YUCATAN.

Well-developed 9-year-old plants from which the sixth semiannual crop has just been cut; total yield to date about 90 leaves per plant.

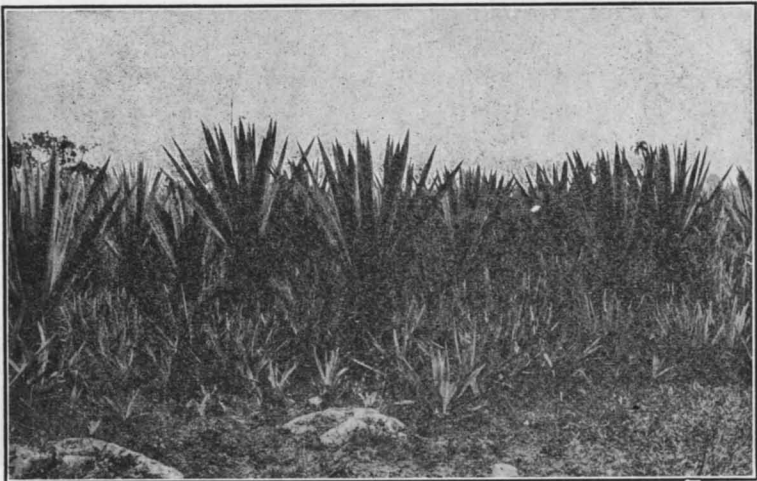

FIG. 2.—HENEQUEN IN CUBA.

Ten-year-old plants which have produced five annual crops, a total of about 150 leaves per plant. Numerous suckers, injurious to mother plants, may be used to stock new plantations.

Plantations have also been established in the States of Chiapas, Sinaloa, and Tamaulipas in Mexico; in Cuba (Pl. XLIX, fig. 2); and, more recently, in Jamaica. Henequen plants have been distributed to some extent in Central America, but, with the exception of limited quantities in Salvador, the fiber is not produced commercially in any of the Central American States. A few henequen plants have been taken to tropical East Africa, the Hawaiian Islands, the Philippine Islands, and India, but the entire production of this fiber outside of Mexico and Cuba is not sufficient materially to affect the total supply.

The true sisal, *Agave sisalana*, is much more widely distributed than henequen. There is scarcely a colony anywhere in the Tropics where sisal plants are not to be found. The principal sisal-producing countries are Java, British East Africa, German East Africa, the Bahamas (Pl. XLVIII, fig. 2), and the Hawaiian Islands, but sisal plantations have also been established in the Philippine Islands, the Caicos Islands, Togoland, Natal, Algeria, Egypt, India, French Indo-China, Taiwan, Australia, New Guinea, Fiji, Jamaica, Curacao, Dutch Guiana, and Demarara.

With this widespread distribution of both henequen and sisal, any attempt to create an artificial monopoly in the production of binder-twine fiber by restricting the exportation of plants from Yucatan is rendered inoperative. An abundant supply of propagating stock is now available in a number of countries other than Yucatan.

CLIMATE AND SOIL REQUIREMENTS.

Henequen and sisal can be grown on a commercial scale only in tropical or subtropical countries, and in localities that are free from frost at any season. The lowest temperature recorded in Yucatan is 48° F., and the annual rainfall is about 30 inches. The annual rainfall of northern Cuba, in the districts where the henequen plantations are located, is about 45 inches.

With respect to the soil requirements of these two plants, opinions and practices of experienced planters differ. Because henequen in Yucatan is grown almost exclusively on soils composed largely of porous, partially decomposed coral rock, the opinion prevails very generally that soils of this

character are essential for both henequen and sisal. Results obtained in other countries, especially with sisal, on soils of quite a different character, indicate that this opinion is not based on facts. Even if it is true that rocky limestone soils do furnish the most favorable conditions for henequen and sisal, no difficulty will be experienced in finding large areas of land of this description in countries other than Yucatan.

In the Hawaiian Islands sisal has been grown successfully, both on the rocky limestone soils near the seacoast and on more fertile soils at higher elevations. It is reported that larger yields of fiber have been obtained on the more fertile soils.

In tropical East Africa the soil conditions considered most favorable for sisal are materially different from the conditions on the henequen plantations of Yucatan, as indicated by the following extract from a report of American Consul Henry P. Starrett:

The soil which appears to give the best results is of a red to chocolate color and of a light, friable nature, or a good sandy loam. It should be well limed if that element is lacking, as the plant will not prosper on sour land.

The successful production on a commercial scale of henequen in Cuba and of sisal in Java, the Bahamas, tropical East Africa, the Hawaiian Islands, and elsewhere, clearly establishes the fact that climatic and soil conditions required for the production of henequen and sisal are to be found in many countries.

As henequen and sisal are relatively low-priced crops, yielding a gross return of from \$50 to \$100 annually per acre during their productive life, which is about two-thirds of the time they occupy the land, they can not be expected to yield satisfactory profits on high-priced land.

The production of henequen can not be conducted profitably on a small scale. An area of not less than 300 acres in bearing is required, as a supply of leaves sufficient to keep a fiber-cleaning machine in operation most of the time must be assured.

PRODUCTION IN UNITED STATES TERRITORY.

As practically the entire output of Yucatan fiber is exported to the United States, and as by far the greater part of the world's supply of binder twine is manufactured in

this country, the problem of increasing the production of binder-twine fiber in territory under the control of the United States is particularly important.

Henequen has been grown successfully in Porto Rico and in the Philippine Islands. Sisal is now produced on a commercial scale in the Hawaiian Islands and in the Philippine Islands, and in small quantities in Porto Rico and Florida. There is no reason why this industry can not be developed in the Philippine Islands, and there are good prospects for its further development in the Hawaiian Islands, Porto Rico, and Florida.

THE PHILIPPINE ISLANDS.

The so-called "maguey," *Agave cantala*, is the species of agave most widely cultivated in the Philippine Islands (Pl. L, fig. 1). The maguey plant and the fiber which is obtained from this plant differ somewhat from both the plant and the fiber of henequen and sisal. The maguey leaf has marginal prickles similar to those of the henequen leaf, and the plants of these two species are very similar in appearance. Maguey fiber is finer and softer than that of either henequen or sisal and is not as well suited for binder twine. For this reason and for the further reasons that the yield of maguey is less than that of henequen and sisal and the maguey leaves are more difficult to clean, an attempt is now being made to replace maguey in the Philippines with sisal.

In 1904 the Philippine Bureau of Agriculture investigated the maguey situation in the Philippine Islands, and organized work to encourage the development of this industry. An attempt was made to improve the methods used on the maguey plantations, sisal plants were imported from the Hawaiian Islands, and two small fiber-cleaning machines were purchased by the Philippine Government and operated for demonstration purposes. This work was continued for a period of 12 years, and an industry of some importance was established. During the year ended June 30, 1917, there were exported from the Philippine Islands 14,461 tons of maguey fiber, valued at \$2,348,247.

As the degree of progress was not entirely satisfactory, and as the increased production of binder-twine fiber in the Philippine Islands is of importance to this country, an ar-

rangement was perfected early in 1917 for cooperation between the United States Department of Agriculture and the Philippine Bureau of Agriculture to encourage the production of binder-twine fiber in the Philippine Islands.

In June, 1917, the Department of Agriculture detailed a fiber specialist for work in the Philippines. Subsequently, 250,000 sisal plants and a modern fiber-cleaning machine were purchased and shipped to Manila. The Philippine Bureau of Agriculture detailed several fiber inspectors on extension and demonstration work in the maguey Provinces, collected and distributed sisal and maguey plants, established nurseries, and purchased two fiber-cleaning machines.

The object of this cooperative work has been to stimulate an interest on the part of the Philippine planters in the increased production of binder-twine fiber; to bring about the more general use of improved methods of planting, cultivating, and harvesting; to encourage the substitution of sisal for maguey; and to introduce machine cleaning in place of the "retting" method now in general use (Pl. L, fig. 2).

As a result of this work there has been a marked increase in the planting of maguey and sisal in the Philippines, with some improvement in methods, although progress in this direction is slow. Sisal plants have been widely distributed, and a number of growers who formerly planted maguey are now planting sisal. Fiber-cleaning machines have been installed and successfully operated. Machine-cleaned Philippine sisal that has been submitted to manufacturers is reported to be superior to Yucatan henequen.

With climatic and soil conditions highly favorable; with large areas of cheap, unoccupied land; and with a fairly abundant supply of cheap labor, there are excellent opportunities to increase largely the production of sisal in the Philippine Islands.

THE HAWAIIAN ISLANDS.

In 1893 the Commissioner of Agriculture and Forestry of the Hawaiian Islands imported 20,000 sisal plants into that country. The results obtained with these plants were so encouraging that a number of sisal plantations were started in different districts of the islands.

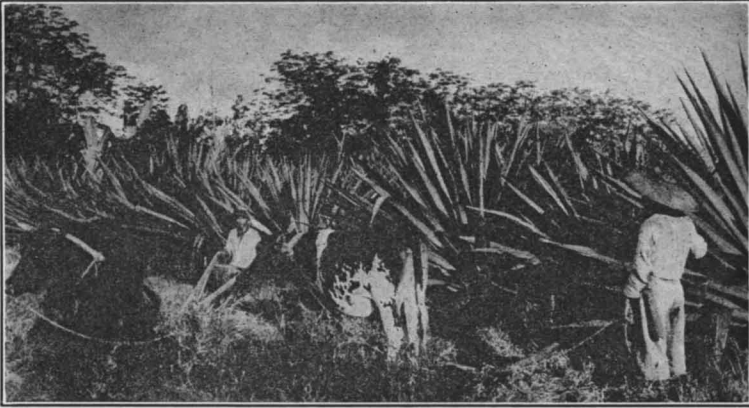

FIG. 1.—MANILA MAGUEY.

Maguey plants at La Carlota Experiment Station of the Philippine Bureau of Agriculture.



FIG. 2.—RETTING MAGUEY.

Fiber-cleaning machines are now being introduced in the Philippine Islands to replace the old method of retting in salt water.

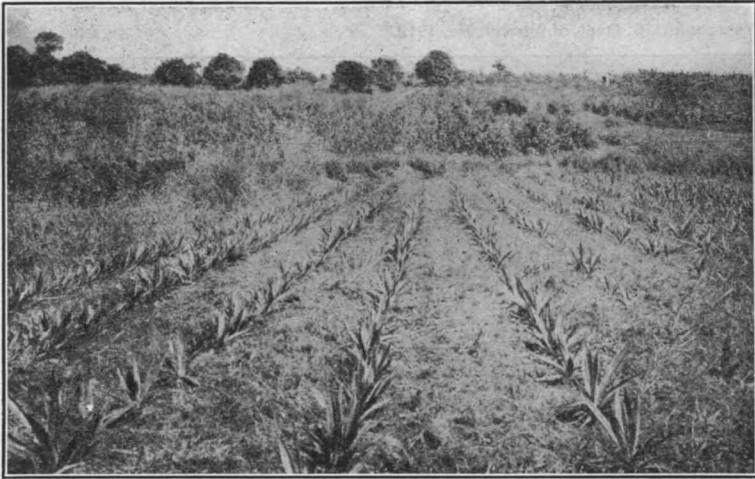

FIG. 1.—SISAL IN PORTO RICO.

Sisal plants in the nursery at the Agricultural Experiment Station, Mayaguez, Porto Rico.

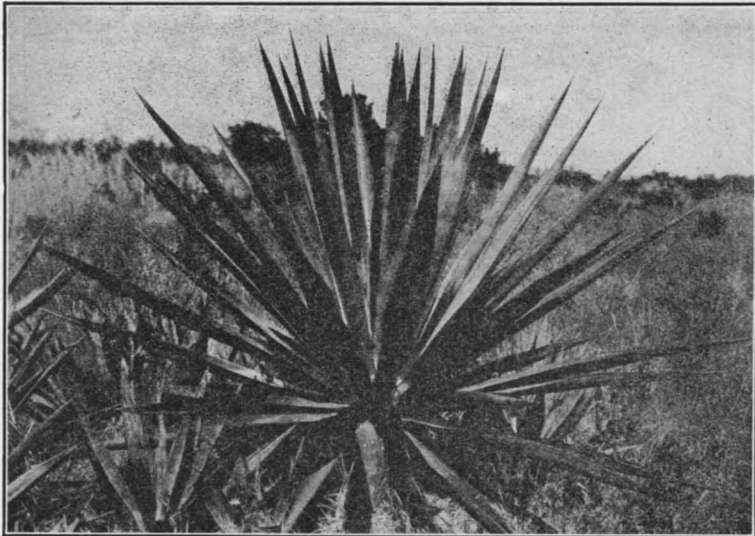

FIG. 2.—SISAL IN FLORIDA.

Sisal plants introduced and naturalized in Florida have furnished propagating stock for almost every tropical colony.

For various reasons the development of the sisal industry in the Hawaiian Islands has not come up to expectations. This has been due, in a large measure, to the fact that the sugar and pineapple industries have absorbed the greater part of the capital and labor available. Two or three sisal plantations are now being operated in the Hawaiian Islands and are producing an exceptionally high grade of fiber. Comparatively large areas of land in the Hawaiian Islands are suitable for sisal, and both climatic and soil conditions are favorable. The labor situation appears to be the most difficult problem in connection with the development of the sisal industry in Hawaii.

PORTO RICO.

Sisal planting in Porto Rico has hardly passed the experimental stage, as no commercial plantations have yet been established in this island. Small areas have been planted, and it has been demonstrated that natural conditions are favorable for both henequen and sisal (Pl. LI, fig. 1). A modern fiber-cleaning machine has recently been shipped to Porto Rico by the Department of Agriculture, which will be operated for demonstration purposes. Limited areas of relatively cheap lands not otherwise used, but well adapted to henequen and sisal, are available, and labor at wages comparable with other tropical countries is fairly abundant.

FLORIDA.

In southern Florida are large tracts of land where the soil conditions are quite similar to the conditions found in Yucatan and in the henequen-producing districts of northern Cuba. Scattering sisal plants are to be found throughout this part of Florida (Pl. LI, fig. 2). The flourishing condition of these plants indicates that sisal production in southern Florida on a commercial scale is at least a possibility. As sisal is a crop that can be grown profitably only on low-priced land, the establishment of this industry in Florida will depend somewhat on land values. The commercial production of sisal in Florida would make it possible to utilize large areas of land now lying idle, and would also result in a reduction in the imports of sisal from foreign

countries. In Florida, as in the Hawaiian Islands, the most difficult problem in connection with sisal production will be that of labor.

Briefly stated, the results thus far obtained show that it will be entirely practicable to develop a flourishing sisal industry in the Philippine Islands, that natural conditions in the Hawaiian Islands and Porto Rico are favorable for sisal, and that it may be possible to establish this industry in Florida.

THE COMMERCIAL APPLE INDUSTRY IN THE UNITED STATES.

By J. C. FOLGER,
Fruit Crop Specialist, Bureau of Crop Estimates.

INCREASING IMPORTANCE OF APPLE PRODUCTION.

IN A CONSIDERATION of the apple production of the United States, a sharp distinction should be made between those apples grown in the farm orchard and those which are grown in commercial orchards. The commercial status of the apple industry depends not upon the apples which are consumed on the farm, fed to live stock, or left to rot under the trees, but upon the portion of the crop which is sold and actually reaches commercial channels. This article will be confined to a discussion of the commercial phases of the industry and to a brief description of the relative importance of different regions and the factors which influenced their development.

In 1918, the estimated value of the total apple crop in the United States, including both commercial and noncommercial apples, was \$229,990,000. Apples ranked ninth in the list of farm crops, being exceeded in total value only by wheat, oats, cotton, corn, potatoes, hay, tobacco, and barley. The total value of the apple crop was about three times that of rice, almost twice that of rye, and about equal to that of barley.

The growing importance of commercial apple production emphasized the urgent need for a more careful study of the apple industry, and the Bureau of Crop Estimates, through its three fruit crop specialists, began an investigation in 1917, which included a survey of every important apple-producing county in the United States. As a result of this investigation, a carefully organized system has been perfected for issuing regular monthly reports during the growing season, forecasting commercial apple production. This service has been extended to peaches, and soon will include pears and other fruits. The data contained herein are the result of this investigation.

It has been only within comparatively recent years that commercial apple growing in the United States has experienced such a very noticeable change from what might be termed a local or home orchard enterprise into a highly intensive and specialized industry. If we are to make a correct analysis of apple growing as an industry and also view the possibilities for its future in the proper light, we must, while not giving less weight to farm orchard production, recognize the fact that commercial apples, which are produced in a relatively few highly intensive regions, largely determine the price of this fruit on the market.

INCREASED PRODUCTION IS LARGELY FROM COMMERCIAL ORCHARDS.

For a long period of years the census has been showing the total number of bearing and nonbearing trees and also total production, but no distinction was made between the trees in home orchards and those in commercial orchards. When the census figures would show a decline in the total production, many people took this as a strong recommendation for planting. As a matter of fact, when the census was showing a decline in total production there were at times actual increases in commercial production. In other words, while the production from the old farm orchards throughout the Middle West and the Eastern States was rapidly decreasing, there were springing up in the Far West and elsewhere highly intensive regions which were increasing the commercial production very materially.

In 1917 the western boxed apple crop produced in Colorado and States west amounted to nearly 40 per cent of the total commercial apple production of the United States. For the past three years western production has approximated one-third of the total commercial crop, yet twenty years ago western production was practically negligible. When we consider the enormous commercial increase in the West, a pronounced increase in the commercial production in the Shenandoah-Cumberland region of Virginia, West Virginia, Maryland, and Pennsylvania, the improved facilities and attention given generally to the distribution, storage, and handling of commercial apples, it must be apparent that our commercial apple production has been steadily increas-



FIG. 1.—A STRICTLY COMMERCIAL APPLE ORCHARD LIKE THOSE FOUND IN MANY INTENSIVE APPLE REGIONS.

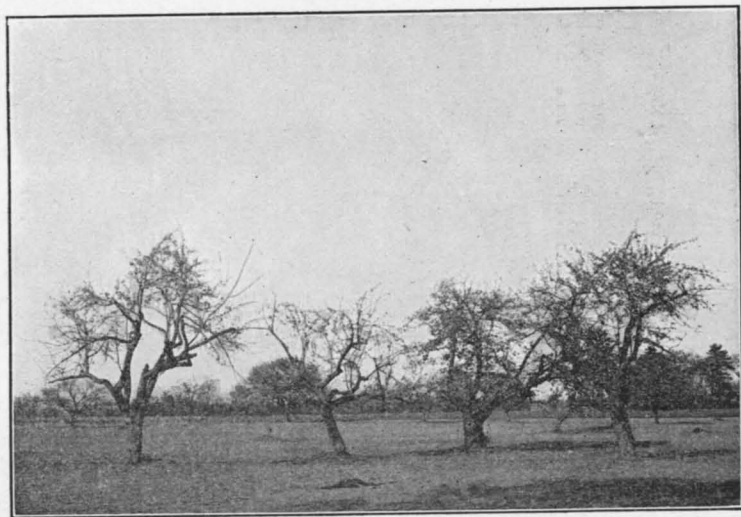

FIG. 2.—APPLE TREES SUCH AS THESE ARE FOUND IN MANY OLD FARM ORCHARDS, BUT THEIR PRODUCTION IS NO LONGER A FACTOR IN THE COMMERCIAL APPLE INDUSTRY.

ing, particularly during the past 10 years. However, if we turn to records of the total production which make no distinction between commercial and noncommercial apples, we find that in total production the crop of 1896 was one of the largest ever harvested, 77,533,000 barrels as compared with the record production of 1914, 84,400,000 barrels.

The point is that during the last 20 years commercial apple growing has made vast strides, while the home orchards have been declining.

FARM ORCHARDS.

It is a generally accepted fact that commercial apples can be successfully grown only when scientific and intensive cultural methods are employed. (Pl. LII, fig. 1.) At the present time in many parts of the United States there is scarcely a farm that does not have its little home orchard, and a great many farm orchards produce a few more apples than are needed at home. Many of these apples go to waste, but sometimes the surplus is pressed into cider, used for other by-products, or in some quantity finds its way into commercial channels during years when prices warrant. Just how great a part the last factor plays in the commercial apple industry is hard to determine, but obviously in the aggregate it is of no little importance. However, the line between commercial and noncommercial product is being more and more closely drawn, and it is a fact that there are a great many apple trees in this country which bear no more relation to commercial production than so many shade trees. (Pl. LII, fig. 2.)

For the purpose of discussing the apple industry in greater detail a number of leading regions will be briefly discussed. (See map, fig. 25.)

NEW YORK.

As early as 1860 the productivity of certain fruit-growing areas in western New York became apparent, and the high marketing quality of the apples from this region caused them to outsell those from other localities. Good quality and large yields were sufficient to overcome the advantage which any other regions may have enjoyed from being closer

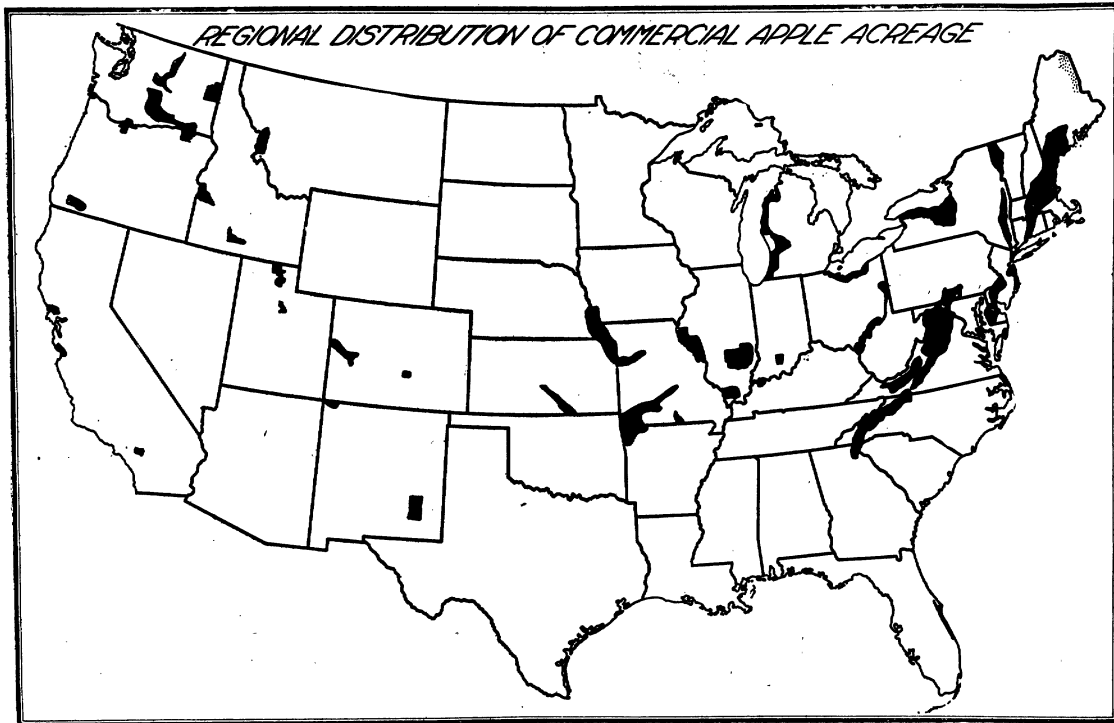

FIG. 25.—It is estimated that over 80 per cent of the strictly commercial apple crop of the United States is produced in the limited areas indicated by the shading.

to market, and the center of commercial apple production was established and has remained in western New York.

One-fourth of the normal commercial apple crop of the United States is produced in the State of New York. Heaviest plantings are found in Niagara, Monroe, Orleans, and Wayne Counties; these are along the lake shore in western New York. In this region most of the present bearing acreage was planted in the late sixties and in the seventies. In other words, the average age of bearing orchards is about 40 years. In few places in this country have trees retained such vigor and productivity at 40 and 50 years of age as in western New York. Yet, productivity of old trees can not be maintained indefinitely, and unless the planting rate is higher than at present a decline rather than an increased production is to be expected from this region. Some idea of the importance of New York as an apple State may be gained from the fact that in 1918 the commercial apple crop was estimated at 42,000 cars. Of this amount about 40 per cent were Baldwins and 20 per cent Rhode Island Greenings.

The Hudson Valley region, although of less importance than western New York, has heavy plantings and is credited with about one-fifth of the New York State production. Baldwin is the leading variety in the Hudson Valley, as elsewhere in New York.

NEW ENGLAND BALDWIN BELT.

Maine, New Hampshire, and Massachusetts are included in what is known as the New England Baldwin belt, so called on account of the prominence of the Baldwin variety, which makes up over half of the total regional production. New England production has been decreasing during recent years, and further declines may be expected from reported loss of Baldwin trees during the winter of 1917-18. The Maine production is equal to the combined normal production of New Hampshire and Massachusetts. Important apple-growing sections are found along Lake Champlain in northwestern Vermont. The commercial apple production of New England amounts to about 5 per cent of the total United States commercial crop.

SHENANDOAH-CUMBERLAND AND PIEDMONT REGIONS.

After a consideration of the important commercial apple regions in Pennsylvania, Maryland, West Virginia, and the lower Shenandoah in Virginia, "Shenandoah-Cumberland" suggested itself as a suitable name for an important region which is limited in area and yet extends into all of the above States. The Shenandoah-Cumberland region has somewhat recently come into prominence and is yet only approaching its maximum production. By mentioning Frederick County, Va.; Berkeley County, W. Va.; Washington County, Md., Franklin and Adams Counties, Pa., and counties in close proximity to these, we are able to define a more or less compact region which rivals western irrigated districts in intensity, and exceeds New England in normal production. The York Imperial is the leading variety for the Shenandoah-Cumberland and the Ben Davis is second in importance.

Leaving the Shenandoah Valley and crossing the Blue Ridge Mountains immediately to the east, one reaches the well-known and very beautiful Piedmont or "Albemarle Pippin" region of Virginia. Orchards here are of the mountain type, and the Yellow Newtown (*Albemarle Pippin*) and Winesap varieties predominate. In point of total production many regions excel the Piedmont of Virginia, but in historic interest and in beauty it is unsurpassed. Albemarle County was exporting "Albemarle Pippins" to England as early as 1759. Thomas Jefferson cultivated this variety at Monticello before the Revolution. It might be well to state that "Albemarle Pippins" draw their Virginia name from the county in which they grow to perfection, but that the variety is properly termed Yellow Newtown. It has been authentically stated that so pleased was Queen Victoria over several barrels of Albemarle Pippins presented to her during the first year of her reign by the late Arthur Stevenson, American minister to England, that she caused the import tax on apples to be removed. Since that time our apple exportations to England have rapidly increased and that country is known as our principal export market.

MICHIGAN AND ILLINOIS.

Michigan is often associated with New York, since Baldwin and Rhode Island Greening are leading varieties grown in both States. The most extensive plantings in Michigan are found in the western part of the State. In quantity, an average crop for this State would be about one-fourth of an average crop for New York.

From the standpoint of total production, Illinois leads all Middle Western States, and its summer apple region in the southern part of the State is one of the most important in the United States. In Illinois, as in all Middle Western States, the question of sprayed and unsprayed acreage is important in considering the commercial apple industry, especially since so many one-time commercial orchards all through the Middle West have been left unsprayed and uncared for, and are rapidly losing their commercial importance. However, a more recent revival of interest is responsible for greater care being given to the remaining orchards, and an important place is always assured for Middle West apples.

OZARK AND MISSOURI RIVER REGIONS.

The Ozark region in southern Missouri and northwestern Arkansas is one of the best known apple regions in the United States, although in point of production it ranks last among the four important Middle West regions. Ben Davis grows to perfection in the Ozark Mountains and until recent years was produced to the exclusion of nearly all other varieties. Winesap and Jonathan are prominent in newer plantings, however. A large proportion of the Ozark crop moves in bulk.

Farther north, in the adjoining sections of Iowa, Missouri, Kansas, and Nebraska, is the Missouri River region, which, although not so well known, has a greater production than the Ozarks. Doniphan County, Kans., deserves particular mention as being an important and progressive apple county. Ben Davis predominates in the Missouri Valley, and as in the Ozarks, a large portion of the crop moves in bulk. If we consider commercial production, the Missouri River region must be credited with about 5 per cent and the Ozark region 3 per cent of the total United States crop.

WESTERN IRRIGATED REGIONS.

Unquestionably the most notable feature in the recent development of the apple industry has been the rapidly increasing commercial crop from Western States, especially Washington, Oregon, Idaho, California, and Colorado. For the past three years approximately one-third of the total United States commercial apple crop has been represented in the production from Colorado and States west. Although far from the center of population and markets, millions of dollars have been expended in the development of apple orchards in the irrigated valleys of the Western States. The high marketable quality of western apples and the phenomenal productivity of western trees tend to offset the disadvantages of long shipment to market. The planting of unsuitable land has been responsible for the pulling of trees in certain districts, but western production is being stabilized, and will continue to be an increasingly important factor in the apple industry.

It is interesting to note the sharp line which separates the barreled-apple States from the boxed-apple States. This line of distinction is particularly important in an analysis of the commercial production. In all Western States the box is used exclusively, while for all States east of Colorado the barrel is the prevailing package. Throughout the Middle West a large portion of the crop moves in bulk, but this movement is essentially competitive with barreled stock. The question is asked, "Will boxing become a common practice among the eastern and middle western growers?" With the exception of a few isolated sections, notably the Arkansas Valley in Kansas and a restricted district in north Georgia, there is no noticeable tendency toward the adoption of the box as a package elsewhere than in the West.

WASHINGTON AND OTHER WESTERN STATES.

Interest in apple production west of the Rocky Mountains centers chiefly in the Pacific Northwest, particularly in the State of Washington. In 1900 this State was relatively unimportant as an apple State, and in 1895 it was absolutely a negligible factor. In 1917, however, Washing-

ton produced 20 per cent of the total United States crop and was the heaviest commercial apple-producing State in the Union, taking precedence even over New York, the latter State having dropped into second place for that year on account of an exceedingly light crop. Washington, with its well known Yakima and Wenatchee Valleys, must be credited with over half of the western apple crop of the past three years. From the standpoint of productivity and intensity of planting the Yakima and Wenatchee Valleys are unsurpassed by any other apple regions in this country. In 1917 these two regions shipped over 16,000 cars of apples. In other words, for that year nearly one-fifth of the total commercial apple production in the United States originated in these two relatively restricted areas. Limited space will not permit a discussion of the rapidity with which these regions have sprung into prominence, nor of the intricate and highly developed methods of handling which have been evolved in the Northwest.

If the Western States were to be ranked in order of their importance in commercial production, California would come second. The limited, but highly productive, plantings of Yellow Newtowns and Yellow Bellflowers in the Pajaro Valley or Watsonville district account for the larger portion of the California apple crop. Although nonirrigated, this region has a wonderful record of large annual crops. After California come Oregon, Idaho, and Colorado, although not necessarily in the order named, since all three States are about on an equal footing, as far as production is concerned.

Interest in Oregon centers, of course, in the famous Hood River Valley, noted for its Yellow Newtown and Esopus ("Spitzenburg") production. This little valley has shipped as many as 1,800 cars in a single year. Idaho's commercial plantings are found in the southern part of the State, and the Colorado crop is produced largely on the western slope in Mesa, Delta, and Montrose Counties. New Mexico and Utah have important but restricted apple plantings, the former in the Pecos Valley and Farmington district, and the latter in Utah and Box Elder Counties.

REGIONS OF MINOR IMPORTANCE.

While in the main the regions mentioned are largely responsible for what is termed strictly commercial apples, there are necessarily many other isolated and important districts which in the aggregate have no small production. The Southern Ohio Rome Beauty section, the Champlain region in New York and Vermont, the orchards of western North Carolina and Georgia, all contribute very materially to the total crop. While not representing a very great portion of the commercial apple crop of the United States, the apple districts in the Brushy Mountains of western North Carolina deserve special mention on account of their unique position in the apple industry. It has been said that many of these mountain orchards were planted to grow apples for apple brandy. With the coming of prohibition, the "Mountain Highlanders" have discovered that the market for fresh fruit affords an outlet for their apples, and they are hauled down the mountain sides, not infrequently by oxen, in hundreds of wagonloads, to find their way into the commercial channels of apple trade.

FUTURE OF THE APPLE INDUSTRY.

Apple production does not respond quickly to supply and demand, and for this reason there has been more or less instability in the matter of prices. It requires several years for trees to come into full bearing, and overproduction as the result of excessive planting is not felt for a considerable period. There seems no reason to believe that over a period of years, taking the good with the bad, apple acreage as a whole will make any materially better returns than the average farm crop, yet apples will always afford better opportunity for individual efforts of the exceptional grower.

Aside from the possibility of certain local "boom development" and the planting of unsuitable land, there seem many reasons for viewing the future of the apple industry as promising. In speculating upon future production, one instinctively turns to New York State. Unquestionably, western New York is approaching its maximum production. The Hudson Valley includes many new orchards, but in the more important parts of western New York the average

orchard is more than 40 years old. Nowhere in the Eastern States, with the exception of the Shenandoah-Cumberland region, does there seem likely to be any early material increase in production. Many of the old trees all through the East are dying out. On the other hand, the Pacific Northwest can be expected to show a constantly increasing production for several years. A very large percentage of the new planting in the decade 1900-1910 occurred in the Northwest. These plantings are to a large extent commercial. Taking the United States as a whole, there has been very little planting in any locality since 1910. It would therefore not seem improbable that this lack of planting will have a pronounced effect, beginning about 1925, if not sooner.

With the cessation of war, the export markets, which normally furnish an outlet for approximately 10 per cent of the United States commercial crop, will be opened. The probable extension of foreign markets will increase this percentage. While a moderate increase in apple production seems probable, the increase in population and the movement toward the cities are factors likely to increase consumption very materially. Furthermore, the improved marketable quality of commercial apples is unquestionably stimulating the demand for this fruit among all classes. Better means of distribution and wider use of the apple combine to give a decidedly hopeful outlook to the commercial apple industry.

**TABLE OF COMMERCIAL APPLE PRODUCTION BY STATES
AND REGIONS.**

*Estimated annual production (in barrels) of commercial apples in the
United States, 1916 to 1918, inclusive.*

[Boxed-apple-producing States are starred, but for convenience their production is given in barrels. To reduce to boxes, multiply by 3.]

States and regions.	1916	1917	1918
STATES.			
	<i>Barrels.</i>	<i>Barrels.</i>	<i>Barrels.</i>
Maine.....	425,000	400,000	225,000
New Hampshire.....	162,000	120,000	121,000
Vermont.....	346,000	135,000	114,000
Massachusetts.....	300,000	225,000	300,000
Rhode Island.....	13,000	11,000	12,500
Connecticut.....	104,000	100,000	120,000
New York.....	6,930,000	2,380,000	7,037,000
New Jersey.....	373,000	408,000	751,500
Pennsylvania.....	1,397,000	911,000	1,177,000
Delaware.....	69,000	186,000	184,000
Maryland.....	217,000	256,000	330,000
Virginia.....	1,995,000	1,650,000	1,766,000
West Virginia.....	1,271,000	702,000	1,145,000
North Carolina.....	218,000	200,000	184,000
Georgia.....	97,000	120,000	117,000
Ohio.....	721,000	532,000	954,000
Indiana.....	262,000	434,000	230,000
Illinois.....	566,000	1,554,000	754,000
Michigan.....	1,414,000	515,000	1,124,000
Wisconsin.....	105,000	124,000	105,000
Minnesota.....	42,000	50,000	33,000
Iowa.....	110,000	250,000	79,000
Missouri.....	675,000	1,128,000	600,000
South Dakota.....	5,000	5,000	3,000
Nebraska.....	142,000	225,000	59,000
Kansas.....	560,000	650,000	333,000
Kentucky.....	157,000	143,000	84,000
Tennessee.....	147,000	150,000	150,000
Alabama.....	19,000	24,000	26,000
Texas.....	20,000	23,000	11,000
Oklahoma.....	27,000	54,000	17,000
Arkansas.....	245,000	402,000	2410,00
Montana*.....	69,000	74,000	75,000
Colorado*.....	367,000	701,000	527,000
New Mexico*.....	59,000	175,000	117,000
Arizona*.....	17,000	16,000	15,000
Utah*.....	3,000	184,000	163,000
Idaho*.....	15,000	906,000	112,000
Washington*.....	3,467,000	4,620,000	4,296,000
Oregon*.....	750,000	713,000	671,000
California*.....	1,210,000	1,174,000	1,127,000
Total United States.....	25,091,000	22,630,000	25,490,000
REGIONS.			
Western New York.....		1,118,000	5,700,000
New England.....		750,000	645,000
Hudson Valley.....		1,074,000	764,000
Shenandoah-Cumberland District.....		2,080,000	2,600,000
Piedmont District.....		578,000	465,000
South Ohio Rome Beauty District.....		121,000	317,000
Western Michigan.....		350,000	826,000
Southern and Western Illinois.....		1,320,000	638,000
Ozark.....		793,000	429,000
Arkansas River Region.....		197,000	123,000
Missouri River Region.....		1,239,000	592,000
Pacific Northwest*.....		6,313,000	5,154,000
Colorado*.....		701,000	527,000
California*.....		1,174,000	1,127,000

* To reduce to boxes, multiply by 3.

GOVERNMENT MARKET REPORTS ON LIVE STOCK AND MEATS.

By JAMES ATKINSON,

Specialist in Live Stock Marketing, Bureau of Markets.

REPORTS ON LIVE STOCK AND MEATS CIRCULATED WIDELY.

STOCK RAISERS have a deep-seated belief that live-stock markets are more or less incorrigible; that the laws of supply and demand operate riotously against the best interests of the producer; and that the gap between the price the consumer pays for the product and the value which the producer receives is too wide, thereby presenting to the latter a constantly menacing future, because of its effect in reducing consumption. This with a score of other causes may be said to account for the relative falling off in live-stock production compared with the increase in the Nation's population.

Under the stimulus of a war necessity, prompt response was made to the country's demand for more meat products, and, with mammoth war orders to fill, the path of wisdom was followed in so placing orders for meat that the producer was reached and thereby encouraged. As these orders decrease there arises a greater need than ever to restore confidence in the markets in order that production may keep pace in the future with the needs of the Nation and in order to give the live-stock husbandman his proper share in maintaining the Nation's trade balance.

The live-stock marketing system of the country has grown up in a somewhat haphazard manner, though its efficiency corresponds in a fair degree with that shown in the production of live stock. On the assumption that the dissemination of market information will tend to improve conditions, the Department of Agriculture, through the Bureau of Markets, has developed a system of market reporting that has already had some effect in restoring confidence in the markets. Among other things, the trade has been furnished a more intelligible basis for market quotations, as

well as information relating to the margin that exists between the price of live stock and the value of meat products. This market reporting system, which was begun in the fall of 1916, has been rapidly developed, and at present there are 16 service centers, each of which distributes daily, weekly, and monthly reports on the various branches of the industry. These include daily reports on meat trade conditions in Boston, New York City, Philadelphia, Washington, Pittsburgh, San Francisco, and Los Angeles; daily reports on live-stock loadings; daily quotations of the Chicago and Kansas City live-stock markets; reports of live-stock movements in grazing and feeding sections; monthly reports on stocks of frozen and cured meats, eggs, and poultry; monthly reports on live-stock receipts and shipments; and monthly estimates on the supply of marketable live stock.

DAILY REPORTS ON THE FRESH-MEAT SUPPLY.

The Bureau of Markets report on meat trade conditions at the leading markets brings to the small dealers, as well as to producers, information that was formerly possessed only by the large meat-packing institutions. (See Exhibit 1.) A corps of specialists obtain full information daily on the fresh-meat supply, including beef of various grades, veal, pork, lamb, and mutton, at the various markets. This information is assembled and distributed widely through a leased wire system to important market centers.

Such facts are furnished relating to each class or grade of meat as to show the relation of supply to demand. Price quotations are made on at least 10 grades of beef, including choice, good, medium, and common steers; good, medium, and common cows; good, medium, and common bulls. (See Exhibit 2.) In a similar manner daily price quotations are furnished on lambs and mutton, the classification being choice, good, medium, and common lambs; good, medium, and common yearlings; good, medium, and common mutton. As applied to fresh meats, this service results in giving to the public full information as to the supply and accurate data on values of all commercial grades. Secrecy is eliminated entirely, so that when prices on meats are high as compared with values on foot it is possible to locate the profiteer. While the information made available by the

bureau is used largely by those engaged in some branch of the meat trade, it is believed that, sooner or later, the public generally will utilize this knowledge and with it bring into line any retailers who reduce consumption by an unwarranted margin of profit.

EXHIBIT 1.—Report of meat trade conditions, Dec. 20, 1918.

[8.30 a. m., Eastern time.]

Washington-----Temperature 28; foggy.
 Boston-----Temperature 28; clear.
 New York-----Temperature 32; clear.
 Philadelphia-----Temperature 38; partly cloudy.

BEEF.

Washington :

Beef, fresh-----Receipts moderate, weak undertone to market, demand light.
 Steers-----Receipts moderate, market unchanged, demand slow.
 Cows-----Receipts light, market generally dull, demand poor.
 Bulls-----No offerings.

Boston :

Beef, fresh-----Receipts liberal, some cars not yet unloaded, market dull but no change in prices since yesterday, demand slow. Kosher beef: Receipts moderate, market steady, demand fair.
 Steers-----Receipts light, market dull at yesterday's prices, demand light.
 Cows-----Receipts liberal, moderate movement to freezer, market draggy at yesterday's prices, demand slow.
 Bulls-----Receipts light, market steady, demand light.

New York :

Beef, fresh-----Receipts normal, market weak and draggy, going out bad. Kosher chucks and plates: Supply liberal, market weak, demand poor. Hinds and ribs: Supply liberal, market steady, demand slow.
 Steers-----Receipts liberal, market weak, demand poor.
 Cows-----Receipts liberal, market weak, demand extremely poor.
 Bulls-----Supply moderate, market weak, demand very light.

Philadelphia :

Beef, fresh-----Receipts fairly liberal, market draggy, selling forced at irregular prices, demand dull, Christmas beef mostly \$30 to \$35. Kosher beef: Supply of chucks and plates liberal, market very dull, demand poor. Hinds and ribs: Supply light, market about steady, demand fair.
 Steers-----Receipts moderate, supplies fairly liberal, market dull at uneven prices, common kinds accumulating, demand limited.
 Cows-----Receipts normal, market dull, demand light.
 Bulls-----Receipts moderate, market weak, demand poor.

VEAL.

Washington :

W e s t e r n

dressed-----Receipts light, market weakening, demand poor.
 Local slaugh-
 tered-----Supply moderate, market dull, prices declining, demand very light.

Boston-----Receipts light, market dull and weak, demand poor.

New York-----Supply normal, market dull, demand limited.

Philadelphia-----Receipts moderate, market weak on heavy calves, light veal steady, demand limited.

PORK.

Washington.....	Supply moderate, market unchanged, demand just fair.
Boston.....	Receipts moderate, market steady, demand light.
New York.....	Supply liberal, market weak, loins going to freezer, demand poor.
Philadelphia.....	Receipts moderate, accumulation heavy, market weak, demand poor.

LAMBS.

Washington.....	Receipts moderate, market weak at yesterday's prices, demand fair.
Boston.....	Receipts moderate, no change in prices since yesterday, demand slow.
New York.....	Receipts liberal, market a little stronger on better grades, demand poor.
Philadelphia.....	Receipts light, market about steady, demand only fair, Christmas lambs at \$25-\$28.

MUTTON.

Washington.....	None on the market.
Boston.....	Receipts moderate, market dull and weak on all grades, demand slow.
New York.....	Receipts liberal, market weak, slow demand.
Philadelphia.....	Receipts moderate, market dull, demand very light.

CHARLES J. BRAND,
Chief of Bureau.

EXHIBIT 2.—Daily wholesale prices, western dressed fresh beef, week ending Dec. 13, 1918.

Market, classes and grades.	Dec. 9.	Dec. 10.	Dec. 11.	Dec. 12.	Dec. 13.
Washington:					
Steers—					
Choice.....					
Good.....	\$24.00-26.00	\$24.00-25.00	\$24.00-25.00	\$24.00-25.00	\$24.00-25.00
Medium.....	20.00-23.00	20.00-23.00	20.00-23.00	20.00-23.00	20.00-23.00
Common.....	15.00-18.00	15.00-18.00	15.00-18.00	15.00-18.00	15.00-18.00
Cows—					
Good.....	18.00-20.00	18.00-20.00	18.00-20.00	18.00-20.00	18.00-20.00
Medium.....	16.00-18.00	16.00-18.00	16.00-18.00	16.00-18.00	16.00-18.00
Common.....	15.00-16.00	15.00-16.00	15.00-16.00	14.50-16.00	14.50-16.00
Bulls—					
Good.....					
Medium.....					
Common.....					
Boston:					
Steers—					
Choice.....					
Good.....	24.00-25.00	24.00-25.00	24.00-25.00	24.00-25.00	24.00-25.00
Medium.....	22.00-23.00	22.00-23.00	22.00-23.00	22.00-23.00	22.00-23.00
Common.....	20.00-22.00	20.00-22.00	20.00-22.00	20.00-21.00	20.00-21.00

Government Market Reports on Live Stock and Meats. 383

EXHIBIT 2.—Daily wholesale prices, western dressed fresh beef, week ending Dec. 13, 1918—Continued.

Market, classes and grades.	Dec. 9.	Dec. 10.	Dec. 11.	Dec. 12.	Dec. 13.
Boston—Continued.					
Cows—					
Good.....	\$17.00-18.50	\$17.00	\$17.00-19.00	\$17.00-19.00	\$17.00-19.00
Medium.....	16.00-16.50	16.00-16.50	15.50-16.50	15.00-15.50	14.50-15.00
Common.....	15.50-16.00	15.00-16.00	14.50-15.50	14.50-15.00	14.00-14.50
Bulls—					
Good.....	15.00-15.50	15.00	15.00	15.00	15.00
Medium.....	14.50-15.00	14.50-15.00	14.50-15.00	14.00-15.00	14.00-15.00
Common.....	14.00-14.50	14.00-14.50	14.00-14.50	13.50-14.00	13.50-14.00
New York:					
Steers—					
Choice.....	27.00	27.00	25.00-26.00	25.00	25.00
Good.....	25.00-25.50	25.00-26.00	23.00-24.00	22.00-23.00	22.00-23.00
Medium.....	20.00-21.00	23.00-25.50	20.00-22.00	18.00-20.50	18.00-20.00
Common.....	16.00-18.00	18.00-21.50	17.00-18.50	17.00-18.00	17.00-18.00
Cows—					
Good.....	20.00	19.00-20.00	17.00-18.00	18.00-18.50	17.00-18.00
Medium.....	16.00-18.00	17.50-18.00	16.50-17.00	15.00-17.00	15.00-17.00
Common.....	16.00-17.00	16.00-17.00	15.50-16.00	12.50-13.50	13.00-14.00
Bulls—					
Good.....
Medium.....	15.00-18.00	13.50-14.00	13.50-14.00
Common.....	14.00-15.00	14.00-15.00	13.50-14.00
Philadelphia:					
Steers—					
Choice.....	28.00-30.00	28.00-30.00	28.00-29.00	27.00-29.00	27.00-29.00
Good.....	24.00-27.00	24.00-27.00	24.00-27.00	24.00-26.00	24.00-26.00
Medium.....	20.00-23.00	20.00-23.00	20.00-23.00	20.00-23.00	20.00-23.00
Common.....	18.00-20.00	17.00-19.00	16.00-19.00	16.00-19.00	16.00-18.00
Cows—					
Good.....	18.00-20.00	18.00-20.00	18.00-20.00	18.00-20.00	18.00-20.00
Medium.....	16.00-17.00	15.00-17.00	15.00-16.00	15.00-16.00	15.00-16.00
Common.....	14.00-16.00	14.00-15.00	14.00-15.00	14.00-15.00	14.00-15.00
Bulls—					
Good.....
Medium.....	15.00	15.00-16.00	15.00-16.00	15.00-16.00	15.00
Common.....	13.00-14.00	13.00-14.00	13.00-14.00	13.00-14.00	13.00-14.00

CHARLES J. BRAND,
Chief of Bureau.

EXHIBIT 3.—*Destinations of live stock loaded Dec. 19, 1918.*

[Double-decks counted as two cars.]

Destination.	Cattle and calves.	Hogs.	Sheep.	Horses and mules.	Mixed stock.	Total.
Albert Lea, Minn.	6	20				26
Alton, Ill.		2				2
Atlanta, Ga.		1		8		9
Austin, Minn.		45				45
Baltimore, Md.	7	10			1	18
Birmingham, Ala.	2					2
Brightwood, Mass.		10				10
Boston, Mass.	6	119				125
Buffalo, N. Y.	5	36	5		17	63
Cedar Rapids, Iowa.	10	58				68
Chicago, Ill.	214	284	29	5	8	540
Cincinnati, Ohio.	12	54			6	72
Cleveland, Ohio.	4	75	4		25	108
Columbus, Ohio.		6				6
Cudahy, Wis.	1	72			2	75
Dallas, Tex.	3	1				4
Davenport, Iowa.	1	4				5
Denver, Colo.	31	24	10	1		66
Des Moines, Iowa.	4	16				20
Detroit, Mich.	2	17				19
East St. Louis, Ill.	96	83	6	4	9	198
Eau Claire, Wis.		2				2
Evansville, Ind.	1	7			9	17
Fort Wayne, Ind.		1				1
Fort Worth, Tex.	46	65			4	115
Harrisburg, Pa.	1					1
Indianapolis, Ind.	21	73			11	105
Jacksonville, Fla.	4	1				5
Jersey City, N. J.	7	19	4		1	31
Kansas City, Mo.	173	216	17	4	20	430
Kearney, N. J.		27	2			29
Lancaster, Pa.	3					3
Los Angeles, Calif.	2	10	2			14
Louisville, Ky.	1	3			3	7
Mason City, Iowa.		17				17
Milwaukee, Wis.	9	53			13	75
Mobile, Ala.	3					3
Moultrie, Ga.		1		1		2
Nashville, Tenn.		12			2	14
Nebraska City, Nebr.		16				16
New Haven, Conn.		42				42
New Orleans, La.	2			1		3
New York, N. Y.	23	85	12			120
Ogden, Utah.		1				1
Oklahoma City, Okla.	65	29				94
Omaha, Nebr.	119	173	23		13	328

Government Market Reports on Live Stock and Meats. 385

EXHIBIT 3.—Destinations of live stock loaded Dec. 19, 1918—Contd.

Destination.	Cattle and calves.	Hogs.	Sheep.	Horses and mules.	Mixed stock.	Total.
Ottumwa, Iowa.....	12					12
Peoria, Ill.....	5	38	2		3	48
Philadelphia, Pa.....	5	39	6			50
Pittsburgh, Pa.....	2	26	7		2	37
Portland, Oreg.....	4	1	6		3	14
Providence, R. I.....		5		2		7
Richmond, Va.....	2	3		1		6
St. Joseph, Mo.....	68	119	3	2	21	213
St. Paul, Minn.....	93	114		1	79	287
Salt Lake City, Utah.....		2				2
San Antonio, Tex.....	5			3		8
San Francisco, Calif.....	28	10	1			39
Seattle, Wash.....	6	5				11
Sioux City, Iowa.....	78	143	25		1	247
Sioux Falls, S. Dak.....	4	46			1	51
Spokane, Wash.....	2	7			5	14
Tacoma, Wash.....	2					2
Terre Haute, Ind.....	1	7				8
Toledo, Ohio.....		4	1			5
Topeka, Kans.....		5		1		6
Washington, D. C.....	1					1
Waterloo, Iowa.....	2	9				11
Wheeling, W. Va.....		15				15
Wichita, Kans.....	11	11		1	3	26
Winona, Minn.....		6				6
Worcester, Mass.....		10		1		11
Various.....	686	152	224	88	6	1,156
Totals.....	1,901	2,567	389	124	268	5,249
One week ago.....	2,356	3,199	529	127	295	6,506
Four weeks ago.....	2,826	1,953	902	200	314	6,195
One year ago.....	1,724	1,230	350	251	211	3,766

STATE ORIGINS OF LIVE STOCK LOADED DEC. 19, 1918.

Destination and State of origin.	Cattle and calves.	Hogs.	Sheep.	Horses and mules.	Mixed stock.	Total.
For Chicago:						
Illinois.....	55	131	10		5	201
Indiana.....	5	38	2	1	2	43
Iowa.....	75	109	9			198
Michigan.....	7				1	8
Minnesota.....	25					25
Missouri.....	4		4			8
Montana.....	4					4
Nebraska.....	4					4
South Dakota.....			7			7

EXHIBIT 3.—Destinations of live stock loaded Dec. 19, 1918—Contd.

STATE ORIGINS OF LIVE STOCK LOADED DEC. 19, 1918—Continued.

Destination and State of origin.	Cattle and calves.	Hogs.	Sheep.	Horses and mules.	Mixed stock.	Total.
For Chicago—Continued.						
Wisconsin.....	21	6	1			28
Canada.....	14					14
Totals.....	214	284	29	5	8	540
One week ago.....	231	1,251	121		53	1,656
Four weeks ago.....	331	106	143	1	39	620
One year ago.....	372	304	100	15	30	821
For Jersey City:						
Illinois.....		6				6
Kentucky.....		4				4
Nebraska.....	1					1
New Jersey.....	1					1
New York.....					1	1
Ohio.....	3	2	4			9
Pennsylvania.....	2	7				9
Totals.....	7	19	4		1	31
One week ago.....	26	12	4		1	43
Four weeks ago.....	3	18	13			34
One year ago.....	13	17	4		3	37
For Kansas City:						
Arkansas.....	2					2
Colorado.....	22					22
Idaho.....	5					5
Illinois.....		1				1
Iowa.....	17	40	6			63
Kansas.....	41	73	3		18	135
Minnesota.....	16	48	1			65
Missouri.....	16	50		4	2	72
Nebraska.....	19	3	6			28
New Mexico.....	28					28
Oklahoma.....	3	1	1			5
Oregon.....	4					4
Totals.....	173	216	17	4	20	430
One week ago.....	199	162	42	2	17	422
Four weeks ago.....	310	178	57	13	16	574
One year ago.....	80	35	6	19	12	152
For New York:						
Illinois.....	10	2				12
Indiana.....	4	11				15
Kentucky.....		4				4
Missouri.....	2	1				3
Nebraska.....	6					6
New York.....	1	30	10			41

EXHIBIT 3.—Destinations of live stock loaded Dec. 19, 1918—Contd.

STATE ORIGINS OF LIVE STOCK LOADED DEC. 19, 1918—Continued.

Destination and State of origin.	Cattle and calves.	Hogs.	Sheep.	Horses and mules.	Mixed stock.	Total.
For New York—Continued.						
Ohio.....		27	2			29
Tennessee.....		10				10
Totals.....	23	85	12			120
One week ago.....	97	25	7			129
Four weeks ago.....	92	77	22			191
One year ago.....	38	25	4	1		68
For Philadelphia:						
Illinois.....	1	3				4
Kentucky.....	2	2				4
Maryland.....	1		2			3
Ohio.....		4				4
Pennsylvania.....	1	30	4			35
Totals.....	5	39	6			50
One week ago.....	4	8				12
Four weeks ago.....	19	27				46
One year ago.....	17	2		2		21

CHARLES J. BRAND,
Chief of Bureau.

LIVE STOCK SHIPMENTS REPORTED EACH DAY.

Daily reports prepared by the Bureau of Markets furnish the industry with information on live-stock shipments. (See Exhibit 3.) In the past, receipts of live stock at the various markets were estimated, this estimate being based on such information as could be obtained from the transportation companies. Although at present the information comes from the same source, it is obtained in a thorough manner, leaving nothing to guesswork. The superintendents of all railroads carrying live stock wire each day to the Bureau of Markets office in Chicago the number of single and double-decked cars of each class of live stock loaded during the preceding 24-hour period, and the destination of each shipment. There the information is tabulated and sent to all points reached by leased wires, from which it is distributed promptly by messenger and by mail.

The wide distribution of information relating to loadings has tended to stabilize values. These daily reports show

the movement of live stock not only to the large market centers, but also to the smaller slaughtering establishments. The daily reports on loadings furnish accurate information that was not available before on the increase or decrease sectionally of live-stock production. Information is furnished to the producer concerning the opening up of new channels of trade, and a knowledge of the demand by smaller plants has a tendency to stimulate competition among buyers, with the subsequent effect of raising values.

Reports on shipments, including stocker and feeder loadings, indicate what may be expected in future marketings, and the development of this service by the Bureau of Markets will ultimately result in having full information regarding the volume of live stock being finished for market. In December, 1917, the bureau was able to show that two and one-half millions of sheep were on feed west of the ninety-seventh meridian, exclusive of Oklahoma, this information being based on the loading reports. With this information available the amount of live stock normally moving from production areas being known, it was possible to regulate the supply of cars needed and to determine whether car shortages for any particular district were apparent or real.

Reports on live-stock loadings make it possible to estimate the receipts with much greater accuracy than heretofore. In the past it has been shown frequently that unofficial estimates have been in some instances as much as 200 per cent greater or less than actual receipts. With these wild estimates eliminated, fluctuation is bound to be lessened and values stabilized in a corresponding degree. It is possible for the shipper to obtain such information from these reports as to enable him to defer his shipment to any particular market or to forward it to a market that is in no danger of being glutted. The better distribution of live-stock receipts resulting from information obtained from the loading reports enables commission men and buyers to render better service in handling live stock after it arrives at the stockyards. Heavy receipts arriving unexpectedly create congestion and confusion, which in turn invariably result in unnecessary shrinkage and costly delays, working in reality an injury to the producer and thereby discouraging production.

A better distribution of live stock not only relieves congestion at live-stock centers, but brings about greater efficiency in the handling of live stock while it is in the possession of the railroad companies. Improving the system of distribution makes fewer cars necessary for the handling of the same amount, and these can be moved with greater dispatch.

EXHIBIT 4.—Chicago live-stock market, 10.30 a. m., Apr. 1, 1919.

HOGS.

Estimated receipts to-day (A), 26,000.	Holdover (D), 3,056.
Market mostly 15 to 25 cents higher than yesterday's average.	
Bulk of sales (F)-----	\$19. 85-20. 00
Top (G)-----	20. 10
Heavy weight (250 pounds up), medium, good, and choice (H)---	19. 90-20. 10
Medium weight (200-250 pounds), medium, good, choice (J)---	19. 75-20. 00
Light weight (150-200 pounds), common, medium, good, choice (K)-----	19. 25-20. 00
Light lights (130-150 pounds), common, medium, good, and choice (M)-----	18. 00-19. 60
Heavy packing sows (250 pounds up), smooth (N)-----	18. 75-19. 25
Packing sows (200 pounds up), rough (P)-----	17. 50-18. 75
Pigs (130 pounds down), medium, good, and choice (X)-----	17. 00-18. 25
Stock pigs (130 pounds down), common, medium, good, and choice (Y)-----	Nonc.

CATTLE.

Estimated receipts to-day (AB), 15,000. Top (AD), -----.
 Market: Few prime steers held higher. Others slow. Bids lower. Choice she stock steady. Others slow to lower. Calves slow to 25 cents lower. Feeders steady.

Beef steers:

Medium and heavy weight (1,100 pounds up)---	
Choice and prime (AF)-----	\$18. 25-20. 50
Good (AG)-----	16. 40-18. 50
Medium (AH)-----	14. 25-16. 75
Common (AJ)-----	11. 75-14. 25
Light weight (1,100 pounds down)---	
Choice and prime (AK)-----	16. 90-19. 00
Medium and good (AM)-----	13. 25-17. 00
Common (AN)-----	10. 25-13. 25

Butcher cattle:

Heifers, common, medium, good, and choice (AR)-----	7. 75-15. 50
Cows, common, medium, good, and choice (AS)-----	7. 40-15. 25
Bulls, bologna and beef (AT)-----	8. 75-12. 75

Canners and cutters:

Cows and heifers (AV)-----	5. 50- 7. 40
Canner steers (AX)-----	7. 00-10. 00

Veal calves:

Light and handy weight, medium, good, and choice (AY)---	12. 75-14. 75
Heavy weight, common, medium, good, and choice (AZ)---	8. 00-13. 00

Feeder steers:

Heavy weight (1,000 pounds up), common, medium, good, and choice (BA)-----	13. 00-15. 75
Medium weight (800-1,000 pounds), common, medium, good, and choice (BC)-----	10. 75-15. 25
Light weight (800 pounds down), common, medium, good, and choice (BD)-----	10. 00-13. 75
Stocker steers, common, medium, good, and choice (BE)-----	8. 25-13. 25

Stocker cows and heifers, common, medium, good, and choice (BF)-----	8. 00-10. 50
Stocker calves:	
Good and choice (BG)-----	10. 50-13. 00
Common and medium (BH)-----	7. 75-10. 50

SHEEP.

Estimated receipts to-day (SA), 7,000. Top lambs (SC), -----.
 Market strong to 25 cents higher. No prime lambs here. Early top, \$20.00.
 Prime wethers, \$17.25. Feeders slow.

Lambs:	
84 pounds down, medium, good, choice, and prime (SD)-----	18. 25-20. 25
85 pounds up, medium, good, choice, and prime (SF)-----	17. 75-20. 25
Culls and common (SG)-----	14. 00-17. 75
Spring lambs, medium, good, and choice (SI)-----	None.
Yearling wethers, medium, good, choice, and prime (SJ)-----	16. 00-18. C5
Wethers, medium, good, choice, and prime (SK)-----	15. 00-17. 25
Ewes, medium, good, and choice (SM)-----	12. 00-15. 25
Ewes, culls and common (SN)-----	6. 00-12. 00
Breeding ewes (full mouths to yearlings) (SO)-----	None.
Feeder lambs, medium, good, and choice (SP)-----	16. 00-17. 50

Above quotations are for woolled (SQ) offerings.

OFFICIAL YESTERDAY.

	CATTLE.	CALVES.	HOGS.	SHEEP.
Receipts-----	(DA) 15,663	(DC) 2,188	(DD) 39,190	(DE) 9,152
Shipments-----	(FA) 3,996	(FC) -----	(FD) 6,876	(FE) 3,413
Packer purchases-----	(GA) 8,883	(GC) 1,638	(GD) 28,616	(GE) 7,687

Estimated receipts for Wednesday, Apr. 2, 1919: Cattle, 7,000; hogs, 17,000; sheep, 5,000.

CHARLES J. BRAND,
Chief of Bureau.

LIVE-STOCK MARKET REPORTS MADE SEVERAL TIMES A DAY.

An important branch of the live-stock reporting system of the Bureau of Markets consists of the telegraphic bulletins prepared by representatives of the bureau stationed at the Chicago and Kansas City live-stock markets. (See Exhibit 4.) These bulletins are issued from time to time during the market hours of each day and report the actual live-stock arrivals and the exact condition of the market. They are transmitted over the bureau's leased wires to other markets where local offices are established, and there the information is displayed on bulletin boards and is furnished to all who make requests for it. Part of these reports is furnished to the commercial news departments of the telegraph companies and in that way disseminated widely. Furthermore, the press associations are using exclusively the information procured by the bureau's representatives in furnishing daily papers with these live-stock reports.

It has been found that the reports emanating from the bureau conflict in many cases with those obtained from other

sources. It should be remembered that the bureau report has to do only with the actual facts in the case, while other reports in many cases are based either on conjecture or unreliable sources of information. More and more all markets outside of Chicago are relying upon these daily reports, and as this market information is posted conspicuously in all of the leading markets, the service becomes of unquestioned value to the producer as well as to the buyer. It is a form of service that enables the commission man to obtain full value for live stock consigned to him, basing those values on prices at the controlling market of the country.

LIVE-STOCK MOVEMENTS IN GRAZING AND FEEDING SECTIONS.

Steady progress has been made by the bureau in collecting and distributing information obtained from grazing and feeding sections. Local offices have been established for this purpose at Lancaster, Pa., and Rocky Ford, Colo., the purpose being to develop a direct service for the benefit of feeders in those localities. By utilizing such knowledge of markets and market conditions as is available, a sensible plan of shipping to and from markets is now being worked out and the excellent results that have come from this line of effort more than justify its rapid development and its introduction to other feeding sections. It is manifest that the work of the bureau along this particular line will tend to lessen market congestion and prevent violent fluctuation in values. Much will be accomplished if only the big fall runs which annually take their toll of millions from stockmen can be distributed. This, as well as many other favorable prospects, all tending to improve marketing conditions, are now plainly in view.

SUPPLY OF MEATS IN STORAGE REPORTED MONTHLY.

It is an advantage to the trade generally to have accurate information regarding the available supply of meats in storage at stated periods, and the Bureau of Markets has made great progress in furnishing this information. All public storages and all packers are required to report to the bureau on their holdings of frozen beef, frozen lamb and mutton, frozen pork, cured beef, dry salt pork, pickled pork, lard, poultry, and miscellaneous meats, and this information is given to the public in a monthly report. (See Exhibit 5.)

In addition to showing the total amount of these products that are stored, these reports of the bureau indicate the amount of the various products stored sectionally, thereby informing the trade of the location of the various commodities. For this purpose, reports are made on the following sections: New England, Middle Atlantic, South Atlantic, North Central East, North Central West, South Central, Western North, and Western South. The character of these monthly reports is such as to make it possible to compare the supply month by month. Wide publicity is given to this information through newspapers and trade papers, and, in addition, the reports are mailed by the bureau directly to all individuals or firms who make application for them.

EXHIBIT 5.—*Stocks of frozen and cured meats on Dec. 1, 1918, with comparisons of the stocks of Dec. 1, 1917, and Dec. 1, 1918, by sections.*

FROZEN BEEF.

Section.	Total stocks Dec. 1, 1918.		Comparison of stocks (includes totals of all storages reporting for both dates).			
	Storages reporting.	Pounds.	Storages reporting.	Dec. 1, 1917, pounds.	Dec. 1, 1918, pounds.	Increase or decrease, per cent.
New England.....	37	18,439,642	36	18,132,682	18,423,468	+ 1.6
Middle Atlantic.....	85	55,161,884	82	43,107,994	51,380,286	+19.2
South Atlantic.....	21	1,331,521	20	1,437,492	1,331,521	- 7.4
North Central (E).....	71	100,683,657	64	116,851,374	80,916,695	-30.8
North Central (W).....	59	34,213,461	53	40,721,956	33,389,885	-18.0
South Central.....	29	5,194,908	29	4,962,835	5,194,908	+ 4.7
Western (N).....	35	6,222,628	30	6,478,215	6,174,819	- 4.7
Western (S).....	35	6,412,025	33	3,971,812	6,405,489	+61.3
Total.....	372	227,659,726	347	235,664,360	203,217,071	-13.8

CURED BEEF.

New England.....	21	1,536,733	21	1,426,085	1,536,733	+ 7.8
Middle Atlantic.....	102	5,531,984	100	5,289,696	5,506,334	+ 4.1
South Atlantic.....	27	408,293	25	577,489	382,193	-33.8
North Central (E).....	97	13,958,640	94	17,330,253	13,488,074	-22.2
North Central (W).....	42	9,296,424	39	12,101,090	9,296,024	-23.2
South Central.....	20	605,058	19	562,205	604,458	+ 7.5
Western (N).....	23	395,535	22	447,921	395,135	-11.8
Western (S).....	26	685,143	26	590,056	685,143	+16.1
Total.....	358	32,417,810	346	38,324,795	31,894,094	-16.8

EXHIBIT 5.—Stocks of frozen and cured meats on Dec. 1, 1918, with comparisons of the stocks of Dec. 1, 1917, and Dec. 1, 1918, by sections—Continued.

FROZEN LAMB AND MUTTON.

Section.	Total stocks Dec. 1, 1918.		Comparison of stocks (includes totals of all storages reporting for both dates).			
	Storages reporting.	Pounds.	Storages reporting.	Dec. 1, 1917, pounds.	Dec. 1, 1918, pounds.	Increase or decrease, per cent.
New England.....	23	965, 934	22	938, 378	965, 891	+ 2.9
Middle Atlantic.....	55	2, 938, 565	52	2, 208, 859	2, 738, 345	+ 24.0
South Atlantic.....	14	163, 889	12	108, 369	163, 889	+ 51.2
North Central (E)....	34	2, 351, 142	29	1, 118, 979	2, 031, 756	+ 81.6
North Central (W)....	36	1, 462, 178	31	428, 480	1, 411, 830	+229.5
South Central.....	16	326, 305	14	61, 675	323, 707	+424.9
Western (N).....	27	204, 473	24	306, 338	198, 103	- 35.3
Western (S).....	21	480, 821	20	233, 976	476, 383	+103.6
Total.....	226	8, 895, 307	204	5, 405, 054	8, 309, 904	+ 53.7

FROZEN PORK.

New England.....	37	3, 655, 343	35	2, 321, 613	3, 568, 833	+ 53.7
Middle Atlantic.....	84	6, 820, 407	78	3, 101, 920	6, 438, 475	+107.6
South Atlantic.....	22	1, 033, 730	22	314, 006	1, 033, 730	+229.2
North Central (E)....	64	9, 051, 559	59	7, 954, 575	8, 876, 422	+ 11.6
North Central (W)....	54	9, 989, 360	50	5, 657, 375	9, 979, 351	+ 76.4
South Central.....	31	1, 658, 584	30	1, 439, 561	1, 657, 584	+ 15.1
Western (N).....	25	798, 426	22	1, 068, 746	792, 869	- 25.8
Western (S).....	28	1, 503, 558	27	1, 646, 279	1, 495, 181	- 9.2
Total.....	345	34, 510, 967	323	23, 504, 075	33, 842, 445	+ 44.0

MONTHLY REPORTS ON LIVE STOCK AT STOCKYARDS.

The wide demand for the bureau's monthly reports on receipts and shipments of live stock in stockyards indicates that this service is considered of great importance. (See Exhibit 6.) The records from 79 stockyards in 71 cities are now compiled, instead of 6 to 12 as heretofore covered by current trade reports, and the classification is such as to show the number of cattle, sheep, and hogs slaughtered as well as the number shipped to other markets each month. The information that is obtained in these reports reveals not only the supply of available market live stock, but also its distri-

bution. Valuable data are received from 63 stockyards in 59 cities on the stocker and feeder movement, and monthly reports are issued by the bureau embodying this information. The producer, by knowing something of the volume of distribution, is in a better position than ever before to determine the length of feeding period that will afford him the most profitable returns and to direct his shipments to markets that are not congested.

EXHIBIT 6.—*Live-stock receipts at stockyards.*

COMPARISON OF DECEMBER, 1918, WITH DECEMBER, 1917.

Market.	Cattle.		Hogs.		Sheep.	
	1918	1917	1918	1917	1918	1917
Albany.....	4,968	20,997	150	12,160	200	16,427
Amarillo.....	13,864	14,854	345	1,246	3,335	7,603
Atlanta.....	825	4,811
Augusta.....	889	790	802	1,090
Baltimore.....	16,351	16,853	98,920	77,209	20,784	9,272
Birmingham.....	2,055	1,528	2,345	274	16
Boston.....	9,270	6,234	997	994	535	150
Buffalo.....	53,370	53,252	186,924	132,290	102,427	81,336
Chattanooga.....	1,156	1,709	1,347	1,233	72	65
Chicago.....	428,924	361,828	999,794	796,082	426,428	336,060
Cincinnati.....	32,703	28,839	162,177	131,770	5,649	2,695
Cleveland.....	18,630	26,177	176,752	123,658	41,083	31,461
Columbia.....	489	284	1,055	988
Columbus.....	111	31	14,750	3,508	26
Dallas.....	1,402	560	3,942	4,201	26
Dayton.....	2,353	2,119	14,662	10,473	200	259
Denver.....	57,140	59,616	37,952	29,209	149,758	135,575
Detroit.....	16,848	26,375	58,250	53,817	38,275	31,645
Dublin.....	20	37	150	83
East St. Louis.....	135,359	122,921	392,067	253,447	32,327	37,312
El Paso.....	10,759	21,902	1,313	1,539	3,698	4,636
Evansville.....	4,307	1,897	28,791	11,918	243	101
Fort Worth.....	126,660	137,537	111,423	70,356	18,289	10,821
Fostoria.....	545	408	15,531	9,255	1,813	1,291
Jacksonapolis.....	34,934	38,740	329,436	312,924	6,055	5,618
Jacksonville.....	1,409	1,794	16,611	7,114
Jersey City.....	51,399	46,810	106,441	52,314	122,222	83,357
Kansas City.....	295,410	237,801	455,430	212,497	92,411	131,011
Knoxville.....	1,626	2,023	325	4,467	569	62
La Fayette.....	1,015	914	24,102	13,669	253	109
Lancaster.....	18,556	26,059	35,071	112,733	11,044	28,365
Logansport.....	104	89	2,826	2,879	38
Louisville.....	13,241	12,808	74,445	78,789	1,078	664

Government Market Reports on Live Stock and Meats. 395

EXHIBIT 6.—Live-stock receipts at stockyards—Continued.

COMPARISON OF DECEMBER, 1918, WITH DECEMBER, 1917—Continued.

Market.	Cattle.		Hogs.		Sheep.	
	1918	1917	1918	1917	1918	1917
Memphis.....	141	108	1,281	81	473	125
Milwaukee.....	31,115	22,836	108,826	55,633	4,599	6,878
Montgomery.....	1,484	1,100	8,766	4,935	538	346
Nashville.....	5,834	6,572	80,521	52,412	435	846
New Brighton.....	11,501	4,031	389	2,182	14,759	2,383
New Orleans.....	15,772	13,644	6,163	5,238	1,086	207
New York.....	26,855	18,445	60,541	56,395	24,215	14,236
Ogden.....	9,974	7,866	11,148	8,310	24,691	17,999
Oklahoma City.....	62,323	43,174	77,938	42,896	2,307	749
Omaha.....	173,443	142,179	360,213	200,007	189,983	252,009
Peoria.....	2,452	1,892	61,308	30,677	110	20
Philadelphia.....	13,425	16,241	29,259	24,018	22,019	16,161
Pittsburgh.....	36,258	45,103	202,483	201,311	43,741	48,750
Portland.....	8,956	8,524	31,753	20,499	13,298	8,759
Pueblo.....	18,242	14,361	2,176	2,427	32,892	93,142
Richmond.....	2,005	1,563	16,111	23,233	764	18
St. Joseph.....	80,622	61,488	315,259	165,071	50,324	52,090
St. Louis.....	11,482	10,104	82,434	68,725	1,288	420
St. Paul.....	130,798	86,470	312,741	245,759	46,207	27,452
Salt Lake City.....	2,487	2,785	6,199	5,051	18,409	14,936
San Antonio.....	12,461	23,504	2,684	3,696	2,042	1,640
Seattle.....	4,893	2,369	20,512	6,144	10,535	333
Sioux City.....	77,915	51,091	235,772	176,044	48,148	42,877
Sioux Falls.....	235	665	11,082	2,444	120
Spokane.....	4,822	2,678	6,381	4,057	980	93
Tacoma.....	1,543	375	4,512	910	3,636	220
Toledo.....	3,993	4,222	43,089	47,472	4,147	5,790
Washington.....	1,913	1,680	5,166	4,513	683	317
Wichita.....	27,361	25,932	73,380	43,743	3,426	1,457
	2,136,997	1,894,788	5,538,024	4,028,069	1,644,683	1,566,171
Erie.....	3,139	6,101	4,710
Marion.....	61	8,744	425
Nebraska City.....	106	36,341
Norfolk.....	75	20
Orangeburg.....	27	2,521
Pasco.....	380	505	2,696
Watertown.....	268

EXHIBIT 6.—*Live-stock receipts at stockyards—Continued.*

COMPARISON OF THE YEAR 1918 WITH THE YEAR 1917.

Market.	Cattle.		Hogs.		Sheep.	
	1918	1917	1918	1917	1918	1917
Albany.....	46,078	106,717	4,510	50,400	702	44,506
Amarillo.....	271,631	351,997	10,855	18,753	54,929	157,991
Atlanta.....	21,715	27,586	46,515	36,172	538	1,857
Augusta.....	13,615	14,086	8,355	6,894	345	293
Baltimore.....	226,846	228,139	804,497	810,320	359,261	349,055
Birmingham.....	21,876	18,551	13,760	2,390	1,173	1,154
Boston.....	103,502	90,602	14,157	19,536	3,745	3,263
Buffalo.....	667,671	531,035	1,300,738	1,114,050	903,553	756,454
Chattanooga.....	13,317	24,616	13,033	14,454	2,656	2,406
Chicago.....	4,447,689	3,820,271	8,614,190	7,168,852	4,629,736	3,595,228
Cincinnati.....	455,291	452,836	1,462,702	1,239,042	274,554	270,329
Cleveland.....	271,630	295,913	1,223,425	898,131	287,422	319,784
Columbia.....	5,192	4,227	3,353	3,786	281	118
Columbus.....	3,491	1,370	65,425	55,419	1,169	298
Dallas.....	11,984	8,401	61,639	87,189	284	452
Dayton.....	29,561	26,034	117,929	87,839	4,421	3,769
Denver.....	728,268	653,377	383,543	351,903	1,651,759	2,059,898
Detroit.....	252,326	262,944	408,372	431,392	278,643	297,391
Dublin.....	2,419	653	3,609	465
East St. Louis.....	1,509,409	1,404,741	3,256,400	2,705,614	536,406	531,034
El Paso.....	211,632	189,916	19,417	20,943	87,754	211,061
Evansville.....	44,643	34,807	221,738	148,122	11,349	8,655
Fort Worth.....	1,665,009	1,959,537	762,486	1,062,021	334,596	405,810
Fostoria.....	9,581	12,322	96,350	66,586	9,643	11,709
Indianapolis.....	504,190	501,156	2,749,976	2,350,730	113,828	102,293
Jacksonville.....	39,764	9,308	72,099	15,913	1,888	35
Jersey City.....	649,620	754,976	566,131	743,582	1,144,972	1,328,771
Kansas City.....	3,319,511	2,902,233	3,327,722	2,276,995	1,667,463	1,498,550
Knoxville.....	19,038	19,626	11,559	13,278	1,891	2,648
La Fayette.....	13,954	14,291	185,949	123,201	4,544	3,632
Lancaster.....	303,705	258,245	577,587	397,695	257,029	159,610
Logansport.....	1,259	1,010	15,421	10,252	478	156
Louisville.....	218,428	220,933	757,912	680,380	256,706	272,059
Memphis.....	3,685	5,040	3,152	401	2,161	242
Milwaukee.....	370,431	295,472	544,944	410,613	57,108	48,051
Montgomery.....	34,295	7,233	47,897	10,035	6,425	1,163
Nashville.....	87,585	117,930	580,961	478,661	108,064	94,345
New Brighton.....	80,663	50,048	3,728	8,249	203,366	82,535
New Orleans.....	174,482	165,823	49,606	57,575	9,144	6,021
New York.....	385,121	276,300	650,708	552,127	271,470	82,771
Ogden.....	117,470	63,779	59,233	57,009	423,316	379,847
Oklahoma City.....	690,109	620,175	571,066	634,291	31,516	50,424
Omaha.....	1,993,366	1,719,822	3,429,533	2,796,596	3,385,696	3,016,631
Peoria.....	31,688	24,737	394,581	262,438	1,195	980
Philadelphia.....	193,663	192,421	273,142	219,074	231,442	185,010
Pittsburgh.....	522,683	559,570	1,808,080	1,745,868	552,848	563,066

EXHIBIT 6.—Live-stock receipts at stockyards—Continued.

COMPARISON OF THE YEAR 1918 WITH THE YEAR 1917—Continued.

Market.	Cattle.		Hogs.		Sheep.	
	1918	1917	1918	1917	1918	1917
Portland.....	119,636	105,409	228,244	221,687	149,331	140,887
Pueblo.....	205,301	185,808	22,653	16,652	761,959	800,302
Richmond.....	22,497	25,966	59,893	77,804	6,919	8,094
St. Joseph.....	869,888	670,167	2,351,013	1,920,177	827,489	678,853
St. Louis.....	123,168	118,045	858,869	741,522	31,621	67,685
St. Paul.....	1,430,408	1,197,129	2,061,390	1,927,952	630,203	429,617
Salt Lake City.....	53,906	41,970	45,015	42,166	423,664	356,712
San Antonio.....	175,919	192,885	30,391	39,686	40,688	51,358
Seattle.....	56,036	39,093	127,036	129,533	51,934	8,781
Sioux City.....	817,593	706,718	2,421,166	2,149,115	387,423	267,441
Sioux Falls.....	6,962	6,972	62,276	5,862	1,509	362
Spokane.....	51,086	25,881	44,339	37,648	102,312	38,878
Tacoma.....	26,883	20,316	31,576	18,759	28,391	27,956
Toledo.....	44,289	32,129	254,875	278,389	28,517	33,771
Washington.....	18,042	15,780	55,604	57,652	8,385	7,200
Wichita.....	393,914	371,307	617,745	494,877	39,842	27,366
	25,204,617	23,056,381	44,870,070	38,404,717	21,787,656	19,856,608
Erie.....	56,582	78,389	108,956
Marion.....	1,510	49,215	2,126
Nebraska City.....	869	273,906	465
Norfolk.....	1,970	2,457	1,632
Orangeburg.....	688	7,652
Pasco.....	2,015	5,153	47,901
Watertown.....	1,479

THE "LIVE STOCK AND MEAT TRADE NEWS."

The various kinds of service that have been enumerated cover the most important branches of the live-stock and meat industry. None of these, however, supplies miscellaneous trade information coming from outside sources, much of which is valuable. In order to accomplish this purpose the "Live Stock and Meat Trade News," a weekly bulletin, was inaugurated in December, 1917. Through it brief summaries of current information published periodically by the Bureau of Markets are given to the public, and news is furnished in a form that is valuable for the use of daily papers, thereby obtaining wide publicity for important items relating to the live-stock industry.

In the very nature of the case, the effectiveness of the bureau's work along the various lines of meat and live-stock reporting depends upon the extent to which the public utilizes the information that is made available. The whole purpose to be accomplished is to improve conditions in the live-stock trade so that production will be encouraged, and, furthermore, to shorten the gap between producer and consumer. Any unwarranted margin of profit on meat products can only lessen consumption and disturb values. It brings conflict between producing and consuming interests where none should exist.

All the reports referred to above are available to the public and are furnished free. The Bureau of Markets at Washington now has a large mailing list, but the list is not long enough nor will it be long enough until it includes the names of all who can be benefited by receiving regularly one or more of these daily, weekly, and monthly reports.

COTTON WAREHOUSING—BENEFITS OF AN ADEQUATE SYSTEM.

WITH A DISCUSSION OF THE RECEIPT UNDER THE UNITED STATES WAREHOUSE ACT.

By ROY L. NEWTON and JAMES M. WORKMAN.

Investigators in Warehousing.

BETTER CONSTRUCTED AND BETTER MANAGED COTTON WAREHOUSES NEEDED.

WAREHOUSING under an adequate system has become essential to the efficient marketing of the cotton crop. Through the lessons taught by the conditions that prevailed in the South during the first year of the great world war, the producer has begun to realize that proper care in the marketing of his products is as necessary as in the tilling of the soil and the planting and harvesting of the crop. He has found also that it is advisable to distribute his sales over a longer period of time.

In meeting this need, unfortunately, too little attention has been given to the essentials of an efficient warehousing system. The necessity of efficient management, of construction in compliance with the standards of the fire underwriters, of responsible business organization, and of the incorporation of terms and conditions in warehouse receipts which will give them a maximum value as security has not been realized. As a result, in many cases the warehouses have been unable to give entirely satisfactory service. Poor construction and the lack of necessary fire protection in many cases have caused almost prohibitive insurance rates; inefficient management and high costs of handling have resulted in excessive storage rates; lack of responsibility, poor business methods, and inadequate terms and conditions in their receipts have given these a low valuation as security and tended to high interest rates when they are used in negotiating loans. Such conditions largely account for the fact that many farmers are opposed to holding their cotton. They have had to pay so dearly for storage and insurance,

and the receipts that have been given them in lieu of their cotton have had so little value as negotiable paper, that they are practically convinced that the storage of cotton does not pay.

THREEFOLD FUNCTION OF THE WAREHOUSE.

“An efficient system of warehousing has for its purpose the lending of every possible facility to aid in the free distribution of merchandise and at the same time providing in the warehouse receipt a method of convenient and economic transfer of title to the stored goods; thus, the bulky goods are turned practically into a paper currency so that transfer of property may be made from one person to another without physical effort or motion and its consequent cost.”¹

The functions of a warehouse in the marketing of the cotton crop are threefold: First, and perhaps the most important, is distribution of the marketing period over a greater length of time; second, protection of the product during the period of conservation; and, third, the financing of the holding movement by providing a negotiable warehouse receipt, which may be used as security to negotiate loans.

PRICE FLUCTUATIONS INFLUENCED BY THE SUPPLY.

For a number of years past the low tide of prices in the cotton market has occurred usually during the four months of the heavy marketing period. Figure 26 illustrates this fact. The fluctuation of prices by months for middling upland spot cotton in New York for a period of 25 seasons, from 1892-93 to 1916-17, and the “American into sight” movement for the same period are shown on this chart. Of the 25 cotton seasons shown, in 16 seasons the low average price actually occurred during September, October, November, or December—the four months of heaviest marketing. Of the exceptions, in 5 seasons the low average price occurred in the month either immediately preceding or following this period, and in 2 it occurred in July. There are only two glaring exceptions to this usual course of events, one being

¹ From an address delivered at an annual meeting of the American Warehousemen's Association.

the season of 1907-8, when the lowest price was reached in April, owing to the general business depression prevailing and the prospects of extremely favorable acreage and condition reports preceding the heavy crop of 1908-9, which was the largest crop in history up to that time, and the season of 1900-01, when the low average price was reached in May.

During the four months when the farmer usually is disposing of his product, the mere fact that he is unloading the great bulk of it upon the market in such a limited period of time may alone be sufficient cause for the price decline. After the greater part of the crop is out of the hands of the producer, usually the price advances. The farmer is apt to believe that this is a result of manipulation and that he is being discriminated against, when in reality the higher price is not necessarily the result of manipulation but probably is the logical result of more efficient marketing methods. The new owners, realizing the value of heeding the laws of supply and demand, distribute their sales over a period of time more commensurate with the needs of the manufacturer and thus, in a large measure, control the price.

THE COTTON WAREHOUSE STABILIZES PRICES.

This condition of affairs has largely accounted for the fact that the facilities available for the storage of cotton heretofore have been located largely in the cities and centers removed from the producing section and therefore have not been available to the producer except through factors and merchants. A great improvement is noticeable in these conditions, however, and in the last two or three years the cotton warehouse has become a factor creating a considerable influence on the primary markets. From a recent survey of the available storage facilities, it appears that there are at present very nearly sufficient warehouse capacities to house the entire average crop, and that these facilities are becoming more and more available to the producer.¹

PROTECTION THE PRIMARY FUNCTION OF THE WAREHOUSE.

Cotton, when properly protected from the elements, offers great resistance to deterioration. Compared with other

¹ Nixon, R. L. Cotton warehouses: Storage facilities now available in the South. U. S. Department of Agriculture, Bulletin 216. 1915.

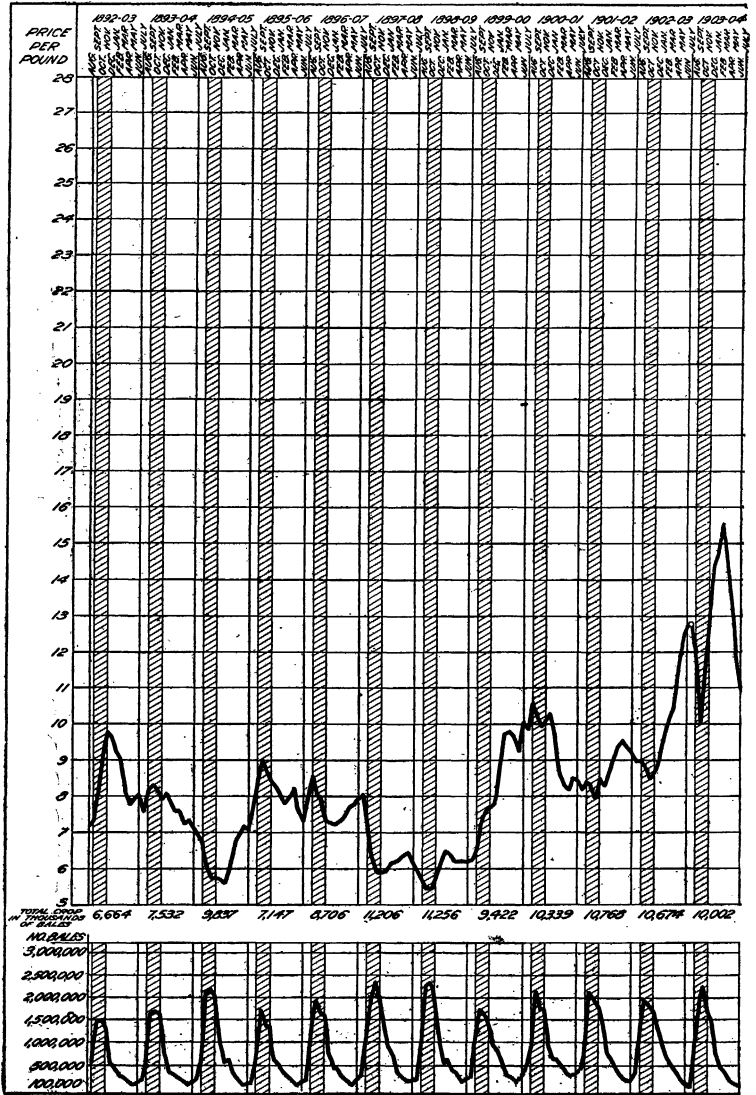
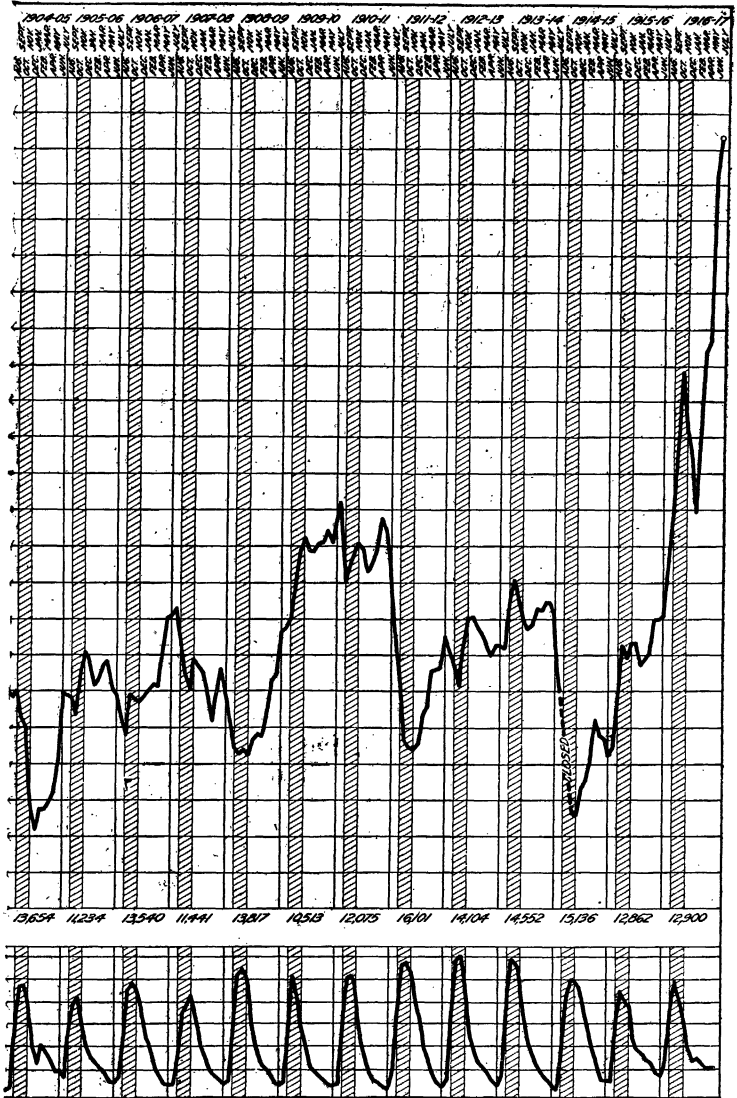

Fig. 26.—A graphic presentation of the fluctuations of New York spot price and the heavy marketing period. Upper curve shows average monthly prices; shaded area shows the four-months period of heaviest marketing.



levels for Middling Upland cotton as related to the "into-sight" movement lower curve shows the monthly "into-sight" movement for the United States;

farm products, it is by far the least liable to "damage" if given a reasonable amount of protection; yet it has been estimated that the annual loss to the South from so-called "country damage" is from \$30,000,000 to \$75,000,000. The most conservative of these amounts would pay the storage on the average crop of 14,000,000 bales for an entire year, figuring the monthly charge at 15 cents per bale, and still effect a saving of almost \$5,000,000. If it be assumed that approximately one-half of the crop suffers "country damage," the rapid movement of the remaining portion obviating such damage, it will be seen that to warehouse these 7,000,000 bales properly for 6 months would practically eliminate the damage loss. In this way, after paying the storage bill, over \$23,000,000 would be saved from even the minimum estimated loss. These figures show that the use of the warehouse is justifiable if its only function were to protect the cotton from "country damage."

THE WAREHOUSE HELPS FINANCE THE COTTON GROWER.

It is very probable that the third function of the warehouse, that of providing a means for financing the period of conservation, is, in most cases, the principal reason for storing cotton; at least, it is reasonable to suppose that very little cotton would be stored and insured if it were not possible to negotiate loans by the use of the warehouse receipt as security.

Bankers and business men generally regard cotton, when properly warehoused and insured and represented by negotiable warehouse receipts, as one of the highest types of collateral. The value of the receipt, however, depends largely upon the financial responsibility of the warehouseman and the terms and conditions of the receipt. If any reason exists for doubt as to the responsibility of the warehouse, its general business policies, or the methods used in the issuance of receipts and the keeping of the warehouse records the value of the receipts is materially reduced. A standardized form of receipt uniformly used is the most desirable.

A COOPERATIVE ORGANIZATION.

It is believed that eventually the cotton growers will have to do one of two things if they are to be properly provided

with warehouse facilities. Either they will have to use the facilities provided in the large centers through factors and brokers or they will have to cooperate in building their own storages in their own communities. So long as the volume of business is as variable as the prevailing price for cotton, it will be almost impossible for the well-constructed and efficiently managed small-town warehouse to operate at a profit, while in the large centers, where the warehouses are assured of a reasonable return on their investment, there always will be adequate storage facilities.

A practical way to provide storage facilities easily available to the producer is to form farmers' cooperative organizations for building and operating warehouses. Where an organization of this nature is not feasible, another plan is to form incorporated stock companies, the majority of stock being sold to producers and the rest to bankers and merchants in the community. In this way all the parties interested in the marketing of the cotton are brought together, and the enterprise is benefited by their mutual interest. In a warehouse of the latter type the question of money dividends on the investment must be of secondary importance, service to the community as a whole being the first consideration.¹

The manager should employ a competent bookkeeper and a weigher and grader, although in a small business it may be possible for the manager himself to perform all the duties of these positions. In any event, he should be familiar with these departments of the business. It is often possible to avoid carrying laborers constantly on the pay roll by employing them by the hour and dispensing with their services when the volume of business permits. The best policy, however, is to have one man always available to assume charge of the "location book" and the placing and removing of the cotton, as his knowledge of the disposal of the bales will materially assist in handling them.

¹The State law under which the organization is to be incorporated influences the type and character of the organization. Some of the States have special laws providing for the formation of cooperative associations; in other States cooperative associations are formed under general incorporation laws. The State laws are far from uniform, and it is therefore important to ascertain the requirements of the laws of the State in which the association is being incorporated in order that the by-laws may be drawn in accordance with the law. See Bassett, C. E., and Jesness, O. B. *Cooperative Organization By-laws*. U. S. Department of Agriculture, Bulletin 541. 1918.

COMBINED COMPRESSING AND WAREHOUSING.

At compress points, it has proved entirely practicable to combine the warehousing and compressing facilities under one management, and this is strongly recommended. The two enterprises are so closely related that duplication of labor and expense may easily be avoided by combining them.

ADVANTAGES OF LICENSED WAREHOUSES.

The recently enacted United States warehouse Act provides a system whereby warehousemen may become licensed by and bonded to the United States Government and operate their warehouses under Government supervision. The benefits to be derived from becoming licensed under this act are found largely in the added value given to the warehouse receipt. Receipts issued by licensed warehousemen have their integrity and uniformity insured, which fact makes them acceptable as security at distant points as well as in the community in which they are issued. This important feature is discussed in greater detail at the end of this article.

LOCATION OF THE WAREHOUSE.

Convenience of patrons and the business interests of the community, proximity to railroad connections and principal highways, suitability of the site of the warehouse, nearness of competitors, and volume of receipts at the point are the factors which fix the location of the warehouse.

RAILROAD CONNECTIONS NEEDED.

Railroad connection is a distinct advantage to the cotton warehouse, both in receiving and in delivering cotton. The field of its operations is broadened if the warehouse can receive cotton shipped by rail, and its patrons are benefited if it can deliver their cotton to railroads without further charges for drayage, etc. Where compress and warehouse are combined, railroad facilities are of the utmost importance, because the operations of such a plant require more cotton than the wagon receipts of the average town will provide; supplies must be obtained from the surrounding territory by rail or water.

A DRY SITE DESIRABLE.

The locality having been selected, the next point to be decided is the site for the warehouse. A soil which does not retain moisture and is of a sandy or gravelly nature is the most desirable. If the natural drainage is not sufficient, artificial drainage should be provided, as it is very important that the warehouse be as dry as possible. The land surrounding the warehouse should also have a natural drainage and be free from depressions which will become bog holes under heavy traffic in wet weather. Areas used for unloading and "lining out" cotton where platforms are not provided should be surfaced with gravel or brick to facilitate handling and afford protection to the cotton.

The site selected should be convenient to the principal highways. Where the producing territory surrounds the town, the warehouse should be near the center of the business section, to obviate cross-town hauls for some of its patrons. This arrangement is advantageous also in that it makes the merchants and bankers easily accessible to the farmer after disposing of his cotton, and the cotton buyers are enabled to keep in close touch with the arriving cotton. It usually is advisable to locate the warehouse in close proximity to competitors. Bad weather conditions likely to prevail during the period of marketing make the need of good roads imperative, and when the warehouse is not located directly on the principal highways, it is advisable to provide good road connections from the warehouse to these highways.

One of the decidedly bad features of the cotton warehouse situation at present is the fact that there are too many warehouses, especially in the smaller towns. Receipts sufficient to permit one well-equipped warehouse to operate with a reasonable profit are divided among a number of poorly constructed, poorly equipped, and inefficiently managed concerns. As a result, none of them succeeds and the quality of the service is materially reduced. Sufficient capacity is desirable in any community, but usually when this capacity is concentrated in one organization the community is benefited to a greater extent than when the business is divided into small portions. For this reason, where there are already several warehouses in the community usually it is the better

plan for the prospective warehouseman to buy and improve one of the establishments, rather than to construct a new house in addition to those already in operation.

WAREHOUSE CONSTRUCTION AND FIRE PROTECTION.

The kind of construction adopted for the warehouse should be governed by local conditions, but very thoughtful consideration also should be given to fire hazard. Very few of the existing warehouses are built with proper regard to the combined effect of arrangement, construction, and insurance requirements. Reports received recently from 1,768 warehouse plants showed that 57 per cent were built of wood or of wood and corrugated iron. This fact, combined with inadequate fire protection, explains many very high insurance rates.

Factors that influence the design of the buildings are the volume and character of the business, the layout of the plant (the arrangement of buildings, platforms, driveways, and railway sidings), the handling methods to be employed, the type of construction, and the cost of construction in relation to fire hazard and resulting insurance rates.

The number of stories and their height are influenced by the methods of storing and handling to be used and the type of construction adopted. Usually the single-story warehouse is desirable, regardless of the type of construction, and the story height should be such as to permit of tiering bales two high on end, or the equivalent in other methods of arrangement, during the rush season.

The generally recognized classes of warehouse construction are fire-resistive, slow-burning, wood-end, and iron-clad. The ordinary frame construction may be permissible in isolated cases.

FIRE-RESISTIVE CONSTRUCTION.

The fire-resistive — sometimes called “fireproof” — construction is desirable where cost and revenue permit its use. In many cases it will be found the most economical construction. The best fire-resistive construction for the cotton warehouse is either reinforced concrete throughout or a combination of reinforced concrete floors and brick division

walls. Exterior walls may be of brick or clay tile, and in some cases clay tile may be used advantageously in combination with reinforced concrete for the roof. As a substitute for brick exterior walls, clay hollow tile may be used where the tile shows a material saving over brick, provided there is no detriment to insurance rates.

SLOW-BURNING CONSTRUCTION.

Slow-burning construction is characterized by heavy interior timbers in combination with masonry walls, with no concealed spaces such as occur in ordinary construction. The timber used for beams and columns should have a minimum sectional area of 64 square inches, and a least dimension of 8 inches for columns and 6 inches for beams. Floor planking should have a rough thickness of not less than 3 inches and roof planking of $2\frac{1}{2}$ inches, both being splined or tongued and grooved. The arrangement of all framing should be such that in case of fire any timber could be burned in two and fall without damage to the supporting wall or column. Wall and column supports for timbers are illustrated by figures 27 and 28.

Division fire walls for slow-burning construction warehouses should extend through and 3 feet above the roof. This extension or parapet should be 12 inches thick. Where the exterior walls are not parapeted, the division wall parapet should be continued through the overhanging cornice and beyond it 18 inches in order to effect a complete fire break.

WOOD-END CONSTRUCTION.

The wood-end warehouse is of the slow-burning design, except that the end walls of the compartments are of light frame construction consisting of 2 by 4 inch studding boarded with lapped siding in order to be spark-proof, and the division fire walls are extended 3 feet beyond the board end wall and terminate within a paved section of the platform if it is of wood, as shown in figure 29. Another form of break, and one preferred by some insurance companies, is that illustrated in figure 30, which shows the wall built in the form of the letter T with the portion of the platform

adjacent to it paved, and with dwarf-walls inclosing the fill under the pavement in case the platform is wooden. This

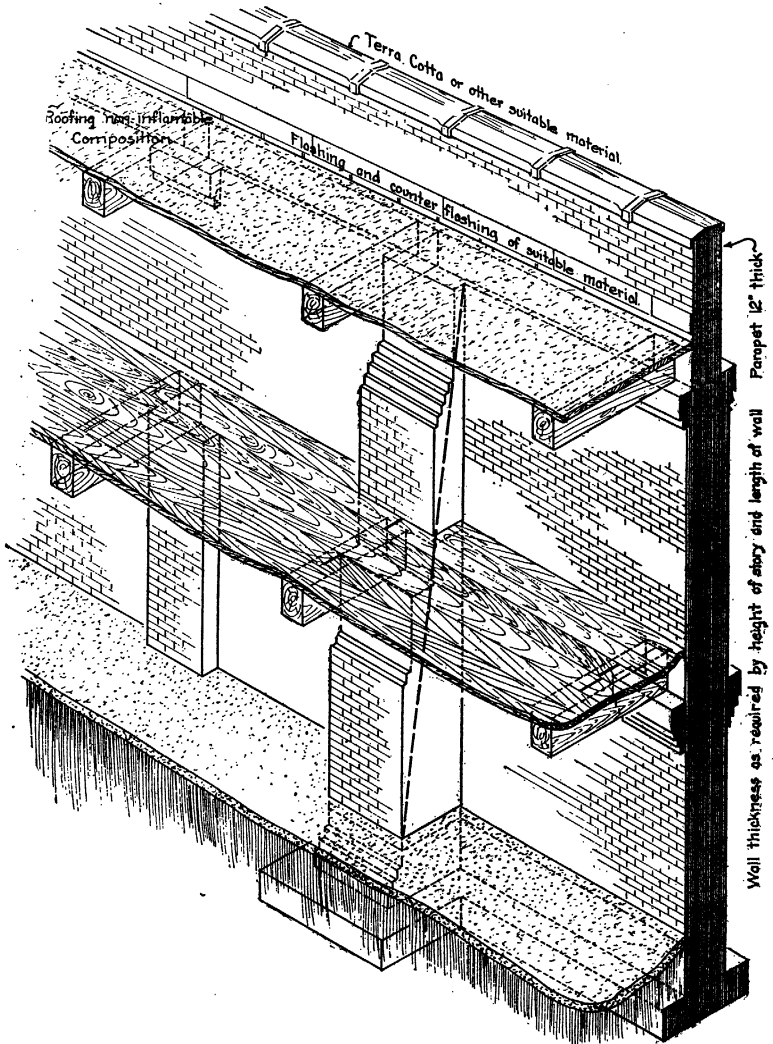

FIG. 27.—Timbers supported by pilasters, corbels, or offsets and self-releasing. Note the buttress (in the foreground) used for bracing long walls.

T should be 12 inches thick and at least 6 feet long, or as required by the insurance companies. Fundamental features of the wood-end design are a low story height, a limit in

storage capacity of 600 bales per compartment, with all bales stored on end one deep, and adequate fire protection.

NOTE. Planking and framing should be proportioned to the loads required and stresses allowed for the material used, but should not in any case fall below the minimum of 2½" for Roof Plank and 3" for Floor Plank thickness; 6" breadth of beam; 8" for least dimension of post and bolster, except that wall posts used as studding may be 6"x6"

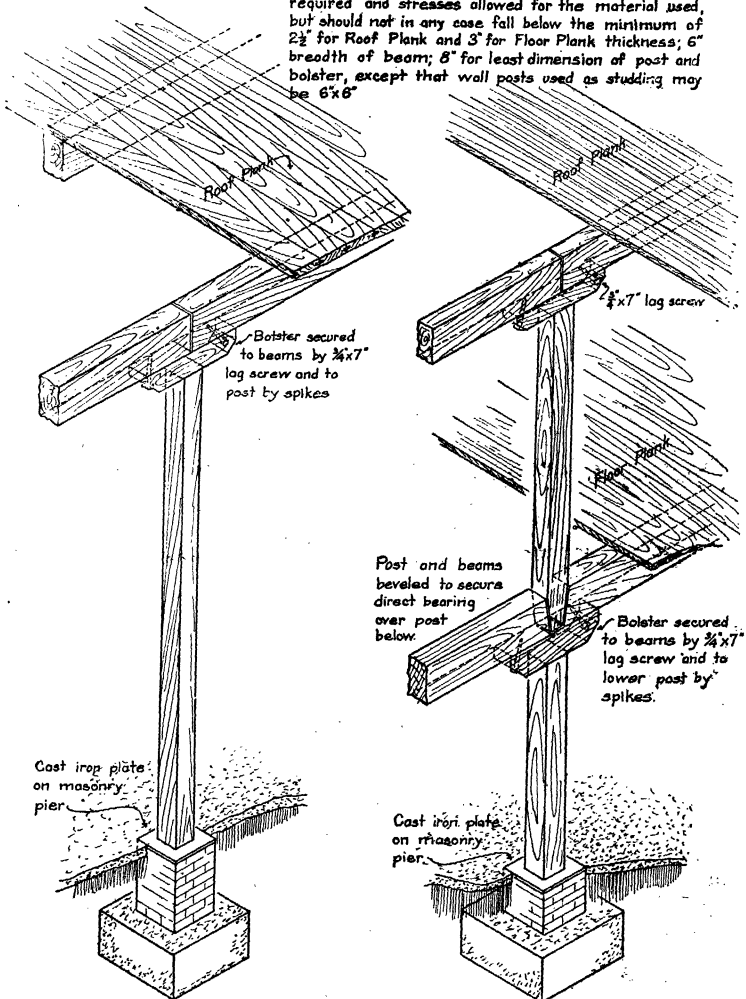

FIG. 28.—An economical method of framing posts and timbers.

IRONCLAD CONSTRUCTION.

The type of construction commonly known as "ironclad," or the warehouse built of a light wood frame covered with sheet iron, fulfills its greatest usefulness for isolated small

warehouses and is used largely on account of the economy with which it can be constructed. This construction is satis-

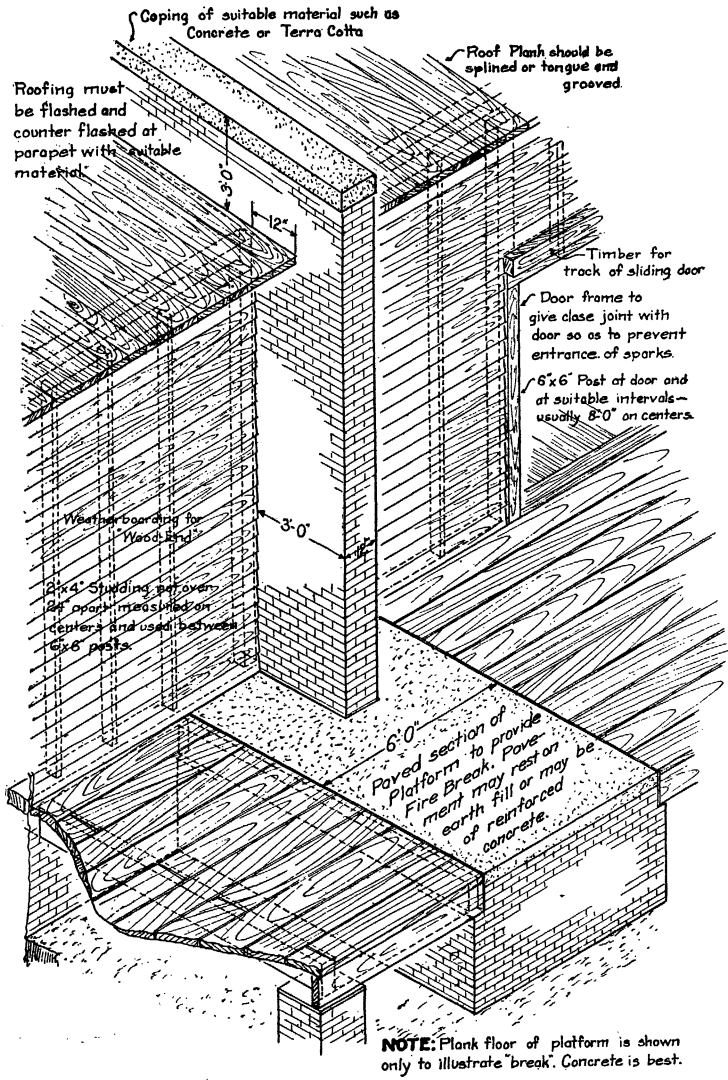

FIG. 29.—Division fire wall arranged as an economical fire stop.

factory from the standpoint of shelter to the stored cotton and is practically proof against exposure to sparks. However, the thin metal affords little protection to the framing

against heat in case of exposure to fire, and the buildings therefore should be not less than 100 feet apart.

The chief objection to the ironclad building is that in case of fire the supporting framework is very quickly destroyed

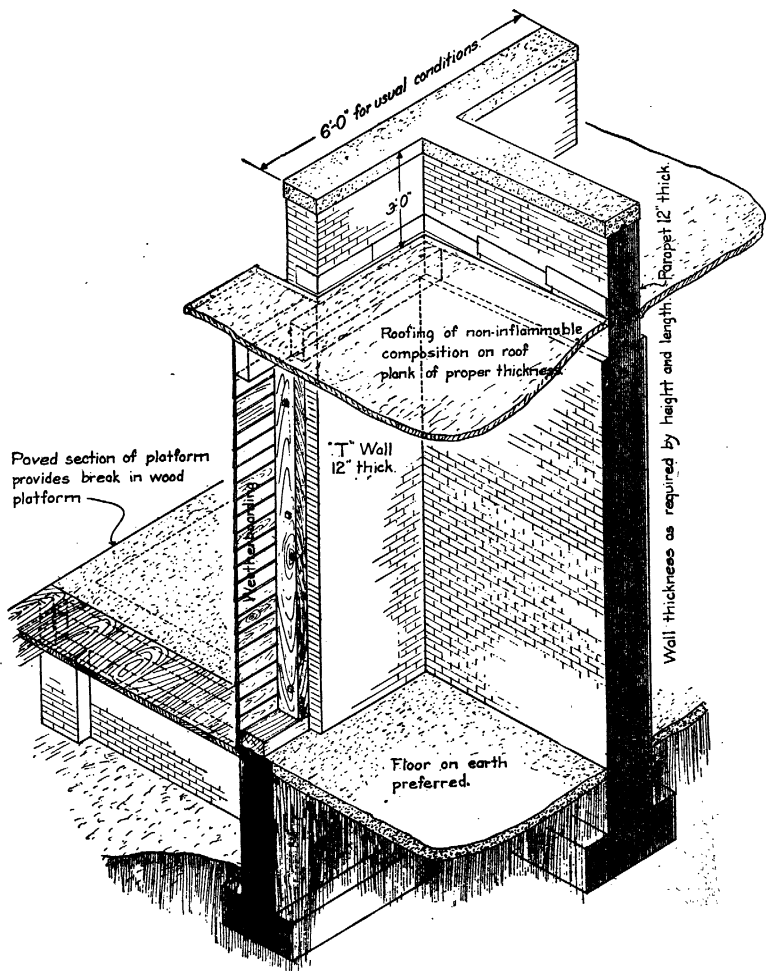

FIG. 30.—Method of forming fire stop by division fire wall without obstruction to platforms.

and the hot metal sheets fall upon the cotton, preventing the application of water. The salvage from such fires is very small. In some climates the ironclad warehouse has a special disadvantage for cotton storage because the sheet-iron

covering is largely responsible for great heat, causing excessive drying out and loss in weight. This, however, is not always the case, as the condition of the cotton when deposited, local climatic conditions, and the period of the year during which the warehouse is used for cotton storage are also influencing factors.

FIRE WALLS, PLATFORMS, AND DOORS.

Fire walls for warehouses of any design should be of sufficient thickness to withstand the action of fire and secure favorable recognition from insurance associations. As these requirements vary, no specific thickness for the wall is stated here. Fire walls of unusual height should be stiffened by pilasters, and walls exceeding 100 feet in length should be braced by buttresses (fig. 27), usually spaced not exceeding 100 feet apart. With the exception of reinforced concrete, hard brick laid in cement or lime-cement mortar is the best material for a fire wall. Reinforced concrete fire walls may be less in thickness than brick walls, the usual allowance being 4 inches.

Platforms should be arranged so as to offer resistance to the spread of fires, and should be so constructed as to facilitate easy trucking. It usually will be economical to make the platform of concrete pavement for the first floor and of reinforced concrete for additional floors. If platforms are wooden they should be separated by a paved area at fire breaks (figs. 29 and 30).

Doors for exterior walls should be spark-proof and, if in exposed masonry walls or in a fire-resistive building, should be covered with tin or made of metal. Doors should not be used in division fire walls unless absolutely necessary, and then should be constructed so as to offer the best resistance to fire. They should be arranged to close by their own weight when automatically released by means of a fusible link or approved mechanical device sensitive to a rise of temperature; or they should be self-closing—that is, arranged always to close by gravity, except when held open. The sliding door is most desirable for practically all warehouse uses. In most cases a compartment should have in each end wall as many as two doors of a minimum width of 6 feet or preferably 7 feet.

EQUIPMENT FOR FIRE PROTECTION.

Protection of the warehouse and the cotton from fire renders the best construction and equipment desirable. Mechanical protection has been highly developed. Recognized means of preventing and controlling fires are watchman service, water barrels and buckets, chemical extinguishers, yard-hydrant equipment, and automatic-sprinkler systems. These items not only safeguard the plant but secure such recognition from insurance companies in the form of reduced rates as makes the investment a monetary saving.

Watchman service supplies very important protection where the watchmen are able-bodied men, alert to their duties. The value of the service is much greater where the modern central-station equipment is in use. Some saving of insurance is gained by this service.

Water barrels and buckets kept filled and available near the doors are of the greatest importance. The insurance requirements vary somewhat regarding the number and location of these, and the warehouseman should acquaint himself with the standards applicable to his plant. Chemical extinguishers are desirable, although the insurance standards vary as to requiring their use.

Yard hydrant piping should be provided, if possible. The system should be fed by an adequate and constantly available supply of water under sufficient pressure, the gravity tank or city main connection being desirable. Fundamental requirements are mains of ample size, in no case less than 6 inches; suitably located hydrants, frost-proof and sufficient in number; and necessary hose and equipment.

The sprinkler system as a means of protection against cotton fires can not be recommended too highly. It consists of a series of "nozzles" or "heads" suspended below the ceiling and connected to a water-pipe supply system. The head is constructed so as to be water-tight normally and to open automatically and serve as a spray nozzle when the temperature is raised above 165 degrees F. This gives the effect of a blanket spray of water, which extinguishes the fire before it has gained headway.

Fire-protective equipment should be installed with due regard to the standard requirements of the insurance com-

panies for the particular territory, as these frequently can be met without material increase in the cost of the installation. As these requirements vary in different parts of the country they are not stated more specifically here.

The effect of fire-protective equipment and construction on the cost of insurance to the warehouse is enormous. This was shown by a survey of cotton warehouses in the South. Out of 1,768 plants only 133 had sprinkler equipment. Warehouses of fire-resistive construction, equipped with automatic sprinklers, paid an average insurance rate of 36 cents per \$100 value per annum on contents, while the non-fire-resistive and nonsprinklered plants paid an average of \$2.43. Furthermore, there are cotton warehouses of moderate cost which, by proper construction and fire protection, secure an insurance rate so low as to be an almost negligible item of expense.

CAREFUL SAMPLING, WEIGHING, AND GRADING OF COTTON ESSENTIAL.

Possibly the most important of the services rendered by the warehouseman, next to the actual care and protection given, are the weighing and classifying of the cotton. Accuracy in these details will insure the confidence of the persons coming into possession of the receipts, so that they may be transferred readily.

The class of the cotton should be ascertained by the use of representative samples drawn from the bale. Poor ginning methods, customary especially at the public gins, are largely responsible for the great quantities of mixed-packed or plated bales. Wagonloads of seed cotton, each probably containing a bale of different quality, coming from different sections, follow each other under the suction pipe. The "rolls" in the gins are not run out between the bales, and as a result each bale has a plate, varying in thickness with the size of the plant, composed of cotton from the preceding bale. There is every possibility that the quality of the two bales will be dissimilar. The practice now in effect is to classify the bale according to its lowest side, and the ginning method above mentioned has without doubt caused great losses to the producer. Samples from bales showing mixed grades or staple

always should be drawn from a sufficient depth to be fairly representative of the bale.

From 2 to 4 ounces of cotton should be drawn from each side of the bale. A curved cut into the bagging between the bands will permit of greater ease in drawing the samples, and if this cut is made properly, the lap of bagging will fall back over the cut and protect the exposed cotton to some extent. In some sections it is customary to take an additional sample from the head of the bale and in others an auger is used with which a sample may be drawn from the interior of the bale.

The practice of retaining a sample to be filed in the numerical order of the tag number identifying the bale is to be recommended. When properly wrapped and numbered, these samples may be referred to at any time without the necessity of locating and resampling the bale after it is placed in the compartment. Racks may be constructed wherein the samples may be filed in the numerical order of their tag numbers. (Figs. 31 and 32.)

Practical forms of the official cotton standards of the United States are available and may be procured from the United States Department of Agriculture at a reasonable cost. The distribution of these forms has done much toward spreading the knowledge of the grading of cotton. By comparing the sample in question with these standards it is not difficult ordinarily to determine the grade. In a short time, frequent reference to the standards becomes unnecessary, as the person grows familiar with the characteristics of the various grades.¹

It has been said that the weight of a bale of cotton can not be determined with absolute accuracy. Theoretically, this is not true, but in practice a variation in weight is almost inevitable. Moisture either will be absorbed into the bale, or that which is in the bale will dry out, so that a variation of from 3 to 5 pounds is considered legitimate in the trade. By far the most popular equipment for weighing cotton in bales is the scale beam and poise supported by the scale frame. On account of its portability, this equipment is still to be recommended for average purposes,

¹ See Earle, D. E., and Taylor, F. Classification of American Upland Cotton. U. S. Department of Agriculture, Farmers' Bulletin 802. 1916.

although the use of the dial platform scale is growing. Greater rapidity and accuracy in weighing with a minimum of labor involved makes this latter type of weighing equip-

CAUTION: THIS IS NOT A COMPLETE WORKING PLAN.
It should be adopted and amplified by detailed drawings and specifications supplied by an engineer.

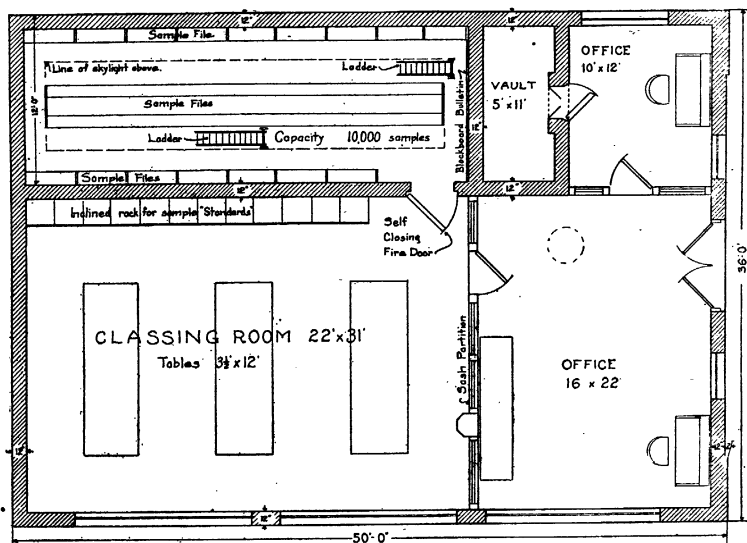

FLOOR PLAN

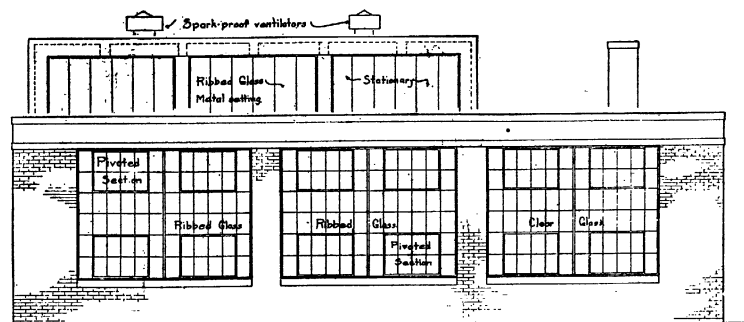

NORTH ELEVATION

FIG. 31.—Plan and north elevation for a convenient office and classing room, with racks for filing samples.

ment preferable where it is not necessary to move the scales about from place to place. A simple locking device makes the platform rigid and takes the strain off the delicate

weighing mechanism while the bale is being rolled on and off the scale by trucks, bale and truck usually being weighed together. In this case either the scale is balanced to deduct

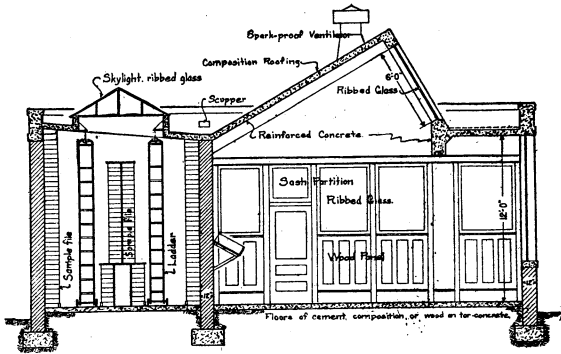

CROSS SECTION



FRONT ELEVATION

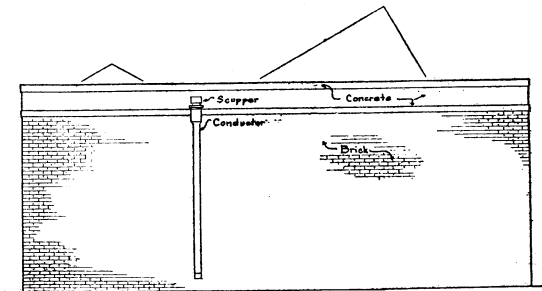

REAR ELEVATION

FIG. 32.—Other drawings of the plan shown in figure 31.

the truck weight, or this weight is deducted in reading the scale.

The purchase of cheap equipment for weighing cotton is to be discouraged. Only the best make of scale beams which

may be depended upon for extreme accuracy of balance and quickness of "break" should be used. Frequent tests by comparison with other equipment, or by the use of United States standard test weights, should be made to insure accuracy. The best of care should be taken of the beam so as to keep it free from rust, which will quickly affect the knives and destroy its accuracy.

WET AND DAMAGED COTTON TO BE CONDITIONED BEFORE STORAGE.

Cotton that is excessively wet or that has become damaged through exposure to weather conditions or by fire should not be brought into the warehouse and handled on the same basis as ordinary cotton in good condition. It is entirely unsafe for a warehouseman to attempt to estimate the amount of moisture or damage, especially where he is to guarantee the weight as stated by him on the warehouse receipts. Since a statement of weight under these conditions is largely guesswork, the practice is almost certain to operate against the interest of either the warehouseman or his patron.

Wet cotton should be thoroughly dried by exposure to the sun and air before being placed in the warehouse compartment. This is especially necessary when the bales are stacked or tiered, as damage to the fiber, with ultimate decomposition, is likely to result if the bales are placed in close contact, where there can be no circulation of air in and around the mass. If it is necessary that bales of cotton in this condition be taken into the warehouse, they should be placed on end on "dunnage" so as to be elevated above the floor, and should be spaced not less than 3 inches apart so as to allow a free circulation of air. Where it is practicable to allow the cotton to dry by exposure to the sun before being placed in storage, it is advisable to pull the heads or ends of the bagging from beneath the end ties, and in extreme cases, to remove or loosen these ties. The bales should be turned from time to time so that all surfaces may be exposed to the sun.

The safest policy for the warehouseman to pursue with regard to cotton that has become damaged through exposure

to the weather or other causes is to require that it be properly conditioned before he accepts it for storage. It is almost impossible to ascertain the extent of the penetration of rot by mere inspection of the exterior of the bale. This is especially true of a bale that is "water packed," that is, where, during the baling process, water has been introduced into the bale, with or without intent, from leakage in the steam packer or other means. Only a very small spot of damaged cotton may appear upon the surface, yet investigation may disclose that a large part of the interior of the bale is rotten.

Processes for removal of the damaged portion of bales are varied and range from the use of steel brushes which may be used to clean off purely surface damage, to extreme measures where it is necessary to remove the bagging and ties from the bale in order to have access to the damaged portions. By removing one or two ties at a time, picking away the damaged parts and replacing these ties before others are loosened, it is possible to keep the bale fairly compact, even when the ties are replaced by hand. In extreme cases, where a major portion of the bale is removed or where the conditioned bale is so soft as to make handling difficult, it is advisable to open the bale, which may then be incorporated with another of similar grade if necessary, and rebaled in a gin press box.

Bales of cotton that have been damaged by fire should be cautiously handled by warehousemen. Fire-damaged bales should be isolated from other bales in the warehouse and, if possible, should not be accepted for storage until the damaged parts have been removed and all danger of smoldering fire has disappeared. If practicable, even after fire-damaged cotton has been conditioned, it should be kept in a separate compartment from other cotton, and certainly not in contact with cotton that has not been so damaged. Conditioned, fire-damaged bales are usually penalized by the manufacturers, and these bales are difficult to detect except by the odor of burned cotton which permeates them. Bales of normal cotton placed in contact with these bales or even in the same compartment are very likely to absorb this odor, which may result in their being penalized as burned bales. In conditioning burned bales, the same methods may be employed as in the case of weather-damaged bales. Care

should be taken, however, to see that the fire-damaged cotton is picked clean from the remainder of the bale. It is usually necessary to use the press box in reconditioning fire-damaged cotton, as new bagging and ties are advisable, and it is often possible to pick away the burned portion to the best advantage while the bale is open in the press box.

DEVICES THAT FACILITATE COTTON HANDLING.

The type of handling equipment which may be useful in the warehouse plant depends on the layout of the warehouse, the volume of the business, and the handling methods employed. The subject may be considered from the standpoint of transporting equipment, hoisting machinery, and tiering or piling devices. The kind of power available may limit the equipment employed.

When cotton bales are to be moved very short distances, the ordinary two-wheeled truck is the best device; but where the distances are considerable, as they usually are at a compress plant, the flat truck or a train of such trucks driven by an electric storage-battery tractor frequently is desirable. In other cases, an overhead trolley system has been used very satisfactorily. This arrangement consists of an overhead track supporting small independent trolley carriers designed for conveying a single bale of cotton by means of cotton hooks. With a proper track arrangement, this system is very flexible and efficient. The track should be carefully graded, and in many cases the bales may be moved entirely by gravity, while in other cases a mule may be used for drawing or pushing a long line of bales.

For elevating cotton, both power-driven whip hoists and elevators are used. Where flat truck loads of cotton are raised and lowered, the elevator is desirable, except in cases where the power trucks may be used on inclined platforms. Where cotton is handled as individual bales, the power hoist is preferable. Another method in use provides an inclined runway in the center of which is a traveling chain or cable provided with hooks so arranged as to engage the axle of the ordinary two-wheeled truck and draw it up the incline. For lowering cotton from one floor to another, the most satisfactory method in many cases is to slide it down a chute

consisting of a simple incline provided with two steel-shod skids and side pieces to serve as guides. Where the warehouse is more than three stories in height, the standard steel spiral chutes are more compact and serviceable.

There are several machines on the market for tiering or piling cotton. Some of these consist of a small portable elevating platform which may be operated by hand or power, while in others the endless belt principle is used. Warehousemen hold varying opinions as to the actual economies effected by the use of these machines. No doubt their real usefulness is influenced by local conditions.

INSURANCE METHODS.

The relation of the cost of insurance to warehousing is very important. The location, surroundings, construction features, and equipment of the warehouse all have immediate bearing upon the insurance rate that applies on contents stored in the warehouse. Excessive cost of insurance is the rule rather than the exception among the warehouses now in operation, especially in those storing for the producer, and this fact is largely responsible for the laxity of the producer in taking advantage of available storage facilities.

The methods of insuring cotton in warehouses vary greatly. Usually the more satisfactory arrangement is for the warehouseman to carry the insurance for his patrons by means of "blanket" policies, paying the premiums on these policies and collecting from the patron by means of regular monthly charges. In this way the warehouseman assumes, in his contract with the depositor, full responsibility for protection of the depositor against loss or damage by fire while the cotton is in his possession, a clause to the effect that the cotton is covered by insurance being inserted in the receipt. The assumption of this responsibility, however, is subject to the owner's preference in the matter, as buyers or dealers often desire to insure their cotton under their own policies. There are a great many advantages in the arrangement of having all insurance matters handled by the warehouseman for his patrons; not the least of these is economy to the depositor. He is relieved from the necessity of obtaining from the insurance company specific policies covering small lots as they

are hauled to the warehouse. He is not obliged to name a specific period for which these policies are to run, nor attend to the cancellation or renewal of them as this period varies. In case of a fire loss the depositor is relieved from adjustments of claims, which may be more expeditiously handled by the warehouseman on the entire lot of cotton affected.

“Blanket” policies which cover cotton owned or held in trust by warehousemen in specified locations almost always contain what is known as a “coinsurance clause,” the meaning of which it is very important that the warehouseman understand fully. A common wording of this clause, as contained in many policies, is as follows:

In consideration of the rate at and [or] form under which this policy is written, it is expressly stipulated and made a condition of this contract that this company shall be held liable for no greater proportion of any loss than the amount hereby insured bears to 100 per cent of the actual cash value of the property described herein at the time when such loss shall happen; but if the total insurance upon such property exceeds 100 per cent at the time of such loss then this company shall only be liable for the proportion which the sum hereby insured bears to such total insurance.

This means that the assured must maintain insurance on the cotton covered by the policy, in an amount equal to its cash value. Failing to do so he becomes the insurer to the extent of the deficit and must bear his proportion of any loss that may occur, the company being responsible only for such proportion of the loss as the amount of the policy bears to the actual cash value of the cotton at the time of the fire. In case the total insurance on the cotton exceeds the cash value the company will be responsible only for the amount of the loss. In other words, if a warehouseman is carrying but \$50,000 worth of insurance on \$100,000 worth of cotton stored in his warehouse and has a fire loss of \$100, he can collect only one-half of the total loss, or \$50, while if he carries \$150,000 worth of insurance on \$100,000 worth of cotton stored in his warehouse and has a loss of \$100,000, he will be able to collect only the amount of his loss.

A practical manner for the warehouseman to arrange for insurance on stored cotton is to cover the value of the cotton by various policies ranging in amount from one to ten

thousand dollars, and having the periods of time during which they are effective range from 3 months to 1 year. As the stock increases in value, additional policies may be taken, or if it becomes necessary to reduce the insurance, the reduction may be made by canceling one or more of the small-denomination short-term policies and collecting the amount of unearned premium from the insurance company.

The value to the warehouseman of an accurate set of records is accentuated in the event of a fire loss, especially when every means of identification of the cotton is destroyed, and the only practical method of determining the value and identity of the burned cotton is to check off on the records the bales remaining unharmed and to assume that the remainder were burned. Insurance policies of the "blanket" type have very strict requirements in this connection. The assured is required to agree to keep a set of books showing a complete daily record of all cotton handled, which record must include the date on which each bale covered by the policy was received, from whom it was received, in what warehouse stored, together with the original tag number or mark of each bale, and its weight and classification, a complete daily record of all deliveries out of the warehouse, and a complete record of all removals from one location covered by the policy to any other location, whether covered or not. Failure to comply with these conditions may result in a nullification of the policy.

In charging a flat monthly rate for insurance, the warehouseman necessarily estimates the average length of time cotton remains in storage and apportions the cost of insurance to this period, thus arriving at the monthly charge. The injustice of this arrangement is apparent. If the cotton remains in storage less than the average time, the warehouseman is the loser on account of the increased cost of short-term insurance, while if it remains longer than the average time, the advantage is with the warehouseman. The short-rate table on page 426, which shows the percentage of the annual premium for one-year policies earned in varying periods of days, may be of assistance to warehousemen in determining their charges for insurance.

Short-rate table for one-year policies.

[Percentage of the annual premium for number of days.]

Days.	Per cent.	Days.	Per cent.	Days.	Per cent.
1	2	18	16	105	45
2	4	19	16	120	50
3	5	20	17	135	55
4	6	25	19	150	60
5	7	30	20	165	65
6	8	35	23	180	70
7	9	40	25	195	73
8	9	45	27	210	75
9	10	50	28	225	78
10	10	55	29	240	80
11	11	60	30	255	83
12	11	65	33	270	85
13	12	70	35	285	88
14	13	75	37	300	90
15	13	80	38	315	93
16	14	85	39	330	95
17	15	90	40	360	100

A GOOD SYSTEM OF WAREHOUSE ACCOUNTS ESSENTIAL TO ADEQUATE SERVICE.

The efficiency of the warehouse depends in a very large degree upon the method used in keeping accounts. The system of accounting should be simple in order to promote accuracy without sacrificing rapidity in handling. It should be comprehensive enough to embody the necessary data, and its plan should be such that these data may be immediately available. Information may be needed with regard to a certain lot of cotton, a certain outstanding receipt, a specific bale in a remote corner of the warehouse, or the exact number of bales a certain patron may have in storage. The records should be such that any one or all of these inquiries may be answered immediately. The forms should be interlocking so that if one fact is known full particulars may be obtained by a reference to that fact.

A system that has been found satisfactory, and which is described fully in a publication of the United States Department of Agriculture,¹ includes the following forms: (1) The consecutively marked tag; (2) the certificate of inspection; (3) the warehouse receipts; (4) the consecutive tag record; (5) the individual account record; (6) the location book; (7) the out-turn order; (8) the daily report; (9) the cash journal; (10) the cash disbursement ticket; (11) the cash

¹Newton, R. L., and Humphrey, J. R. *A System of Accounts for Cotton Warehouses.* U. S. Department of Agriculture Bulletin 520, 1917.

receipt ticket; (12) the sale ticket. Printer's copies of all these forms may be secured from the Bureau of Markets, United States Department of Agriculture.

THE WAREHOUSE RECEIPT UNDER THE UNITED STATES WAREHOUSE ACT.

The thing above all others of vital interest to the warehouseman, as well as to the depositor of cotton in the warehouse, is the value of the receipt which is given in lieu of the stored goods. This receipt is the guarantee of the warehouseman that he holds in trust and will deliver upon demand the goods represented by it, and it represents to the depositor the value of the stored product. Three important factors control the value of the warehouse receipt: First, the known integrity and financial responsibility of the issuer; second, the desirability and accuracy of its terms and the description of the stored goods contained in it; and, third, its uniformity.

Bankers regard cotton as a collateral of the highest order when it is properly warehoused, insured, and made liquid and easily handled through warehouse receipts showing accurate grade and weights. A form of security that has become standardized and uniform is the most desirable as a security, and transactions involving the use of a security of this nature always command the lowest rates of interest.

The outbreak of the European war emphasized the fact that the machinery for marketing cotton then in use was inefficient and unjust to the producer. There was no adequate method by which to finance conservation, and with the withdrawal of the market, prices collapsed, creating a near panic and causing great losses to the producer. The United States Warehouse Act was a recognition by the Government that the most serious weaknesses in the existing system of cotton marketing were: (1) a lack of adequate storage facilities properly distributed; (2) a lack of proper control and regulation of the existing facilities; (3) an absence of uniformity in the methods of warehousing and in the form of receipts issued; (4) an absence of the proper relationship between the producers and the extenders of credit.

The Act is designed to create a system of licensed and bonded warehouses, issuing uniform receipts, and regulated

by Government supervision and inspection. It is expected that, in the receipts issued by these warehouses, a security of unquestionable value will be created, which will be of definite assistance in financing and which will flow at once into the general system of securities and become liquid at any time in the security markets.

By the terms of the United States Warehouse Act the Secretary of Agriculture is authorized (1) upon application to him to issue to any warehouseman a license for the conduct of a warehouse or warehouses for the storage of agricultural products in accordance with this Act and the regulations thereunder, and the term "agricultural product" wherever used in the Act is deemed to mean cotton, grains, flaxseed, tobacco, and wool, or any of them; (2) to inspect warehouses licensed or applying for license under the Act; (3) to prescribe the duties of persons licensed under the Act; (4) to make general warehousing investigations; (5) to license competent persons to weigh and classify agricultural products stored or to be stored in warehouses licensed under the Act; (6) to establish and promulgate standards by which agricultural products are to be classified where such standards are not already established under authority of Federal law; (7) under certain conditions, to cancel or revoke licenses issued under the Act; and (8) to exercise general supervision over warehousemen and weighers and classifiers licensed under the Act. In order to become licensed, the Act provides that the warehouse must be found a suitable place for the proper storage of the product; that the warehouseman must agree to abide by the Act and the rules and regulations promulgated thereunder; and that he must execute and file with the Secretary of Agriculture a good and sufficient bond other than personal security to guarantee the faithful performance of his obligations as a warehouseman under the laws of the State in which he is conducting such warehouse as well as under the terms of the Act and the regulations thereunder, and such additional obligations as may be assumed under contracts with the depositor.

The terms and the conditions of the receipt as required by the Act and the rules and regulations are designed to safeguard the interests of both the warehouseman and the depositor. In addition to the terms required by section 18 of

the Act, which are substantially the same as the requirements for receipts under the Uniform Warehouse Receipts Act, the rules and regulations of the Secretary of Agriculture¹ for cotton warehouses require the following provisions in every receipt (figs. 33 and 34):

(1) The name of the licensed warehouseman and the designation, if any, of the warehouse; (2) the license number of the warehouse; (3) the date of expiration of the warehouseman's license; (4) the class of the warehouse (as designated by the Secretary); (5) a statement whether the warehouseman is incorporated or unincorporated, and, if incorporated, under what laws and the amount of the paid-in capital stock; (6) the tag number given to each bale of cotton; (7) the amount of the warehouseman's bond; (8) a statement conspicuously placed whether or not the cotton is insured, and, if insured, to what extent, by the warehouseman against loss or damage by fire and lightning; (9) a blank space designated for the purpose in which the length of staple may be stated; (10) the words "Negotiable," "Nonnegotiable" or "Not negotiable," according to the nature of the receipt clearly and conspicuously printed or stamped thereon; (11) a specification of the period, not exceeding one year, for which the cotton is accepted for storage under the Act and the regulations. (The regulations provide in this connection that upon demand and the return of the old receipt by the holder thereof, at or before the expiration of the specified period, the warehouseman shall, within certain limitations, either issue a new receipt, or extend the old one by making a suitable notation thereon.)

If the receipt be negotiable, the following conditions are required in addition: (12) If the cotton covered by the receipt was classified by a licensed classifier or weighed by a licensed weigher, a statement to that effect; (13) if the licensed warehouseman guarantees the weight and class in accordance with paragraph 2 of section 2 of regulation 4 of the regulations, a statement of such guarantee; and (14) a form of indorsement which may be used by the depositor, or his authorized agent, for showing the ownership of, and

¹ Regulations of the Secretary of Agriculture under the United States Warehouse Act of August 11, 1916. Regulations for Cotton Warehouses. U. S. Department of Agriculture, Office of the Secretary, Circular 94. 1918.

liens, mortgages, or other incumbrances on the cotton covered by the receipt.

W. A. Form No. 6 Cotton

[THE DOE WAREHOUSE CO.]

INCORPORATED UNDER THE LAWS OF [STATE] PAID IN CAPITAL STOCK \$[AMOUNT]

LICENSED AND BONDED UNDER THE U. S. WAREHOUSE ACT

RECEIPT No.

CLASS [A] AMOUNT OF BOND \$[AMOUNT] ORIGINAL NEGOTIABLE

WAREHOUSE RECEIPT FOR ONE BALE OF COTTON

[Town State] [Stamp date]

Received for storage from of on [Stamp date]
 one bale of cotton described below, stored in [The Doe Warehouse Co.] in [Town State], for which this receipt is issued, subject to the United States warehouse Act, the regulations for cotton warehouses thereunder, and the terms of this contract:

Tag No. Marks Weight Grade* Staple

Condition

Said classification and weight were determined by a classifier and weigher licensed under said Act, and are guaranteed as provided in paragraph 2, section 2, regulation 4 of said regulations.

Said cotton is fully insured by [The Doe Warehouse Co.] against loss or damage by fire and lightning unless expressly stated otherwise on the face of this receipt.

Said cotton is accepted for storage for (one year) only from the date of this receipt, but, upon surrender of this receipt, said period may be extended, or a new receipt issued, at the option of [The Doe Warehouse Co.] as provided in said regulations.

The [Doe Warehouse Co.] claims a lien on said cotton for charges, advances made, and liabilities incurred, as follows:

Storage from date of receipt of cotton at the rate of cents per month or fractional part thereof.

Insurance from date of receipt of cotton at the rate of cents per month or fractional part thereof.

Weighting \$

Classing \$

Stapling \$

Freight charges \$

Money advanced \$

Miscellaneous \$

Upon the return of this receipt properly indorsed and the payment of all charges, advances and liabilities due [The Doe Warehouse Co.] therefor, said cotton will be delivered to or his order.

Licensed warehouseman

per

*Grade according to the official cotton standards of the United States.

ORIGINAL NEGOTIABLE

FIG. 33.

In addition to the requirements as to the terms and conditions of receipts, the regulations specifically cover such points as the procedure in case of issuance of duplicate receipts

where the original is lost or destroyed, partial delivery, the return and cancellation of receipts prior to delivery of cotton, and the statement of grade and weight on the receipt. Means

INDORSEMENTS.

.....
.....
.....
.....
.....
.....
.....
.....
.....
.....

are also provided by which interested persons may appeal from the grade or class of cotton as stated on receipts issued under the Act.

Definite contractual relations between the depositor, the warehouseman, and the Government, through the Secretary of Agriculture, are established by the provisions of the Act. The legislation is entirely permissive, and the warehouseman is required to agree, over his signature, to abide by the terms of the Act and the rules and regulations promulgated thereunder before the license will be issued.

STATEMENT OF OWNERSHIP AND INCUMBRANCES.

I hereby certify that

is the owner of the cotton described on the face of this receipt and that, other than the following, there are no liens, mortgages, or other incumbrances on such cotton:

.....
.....
.....
.....
.....

(Signed)

FIG. 34.

[Back of W. A. Form No. 6.]

conditions of the receipts will equalize their value in different localities; (2) Federal supervision will give the receipt a value that can not be obtained through personal or even

Section 14 of the Act provides that "any person who deposits agricultural products for storage in a warehouse licensed under this Act, shall be deemed to have deposited the same subject to the terms of the Act and rules and regulations prescribed thereunder." The receipt issued will be a very definite contract between the depositor and the warehouseman.

The most important benefits to be derived from the United States Warehouse Act are: (1) Uniformity in the terms and conditions of the receipts will equalize their value in different localities; (2) Federal supervision will give the receipt a value that can not be obtained through personal or even

State operation; (3) the statement of class and weight on the receipt, when made by the persons licensed under the Act, will furnish an accurate, substantial basis of valuation; (4) producers of farm products, holding receipts issued under the Act, will be brought into intimate touch with those who have credit to extend; (5) with adequate credit available, and with a definite idea of the value of his product, the producer will be in a position to market his product more intelligently; (6) by becoming licensed the warehouseman will be able to secure lower insurance rates on the cotton stored in his warehouse.

Applications for license as warehouseman, weigher, and classifier may be made to the Secretary of Agriculture, on forms prescribed for the purpose and furnished by the Chief of the Bureau of Markets.

ARABLE LAND IN THE UNITED STATES.

By O. E. BAKER, *Agriculturist*, and H. M. STRONG, *Assistant in Agricultural Geography, Office of Farm Management.*

THE PURPOSE of this article is to describe, only in outline, the location and extent of present arable, nonarable, and potentially arable land in the United States, with a view to providing those interested in land utilization with a broad, generalized conception of the subject.

PRESENT ARABLE LAND.

It will be seen from map 1 that most of the present arable land in the United States ("improved land" according to the Census terminology) lies east of the 100th meridian, and is concentrated in a triangular area roughly bounded by a line from southwestern Pennsylvania across Kentucky and Missouri to central Oklahoma, thence northerly to north central North Dakota, and thence southeasterly across Minnesota, Wisconsin, and Michigan to the point of beginning. In this region, which includes only one-fifth of the land of the United States, are produced four-fifths of the corn, three-fourths of the wheat and oats, and three-fifths of the hay crop of the Nation. No region in the world of equal size affords so favorable natural conditions for the growth of corn, the most productive per acre of the food crops, and few regions possess so favorable conditions for the culture of the small grain and hay crops.

Outside this region the only areas where more than half of the land area was improved farm land in 1910 were central and western New York, southeastern Pennsylvania and adjoining sections of New Jersey, Maryland, and Virginia, the Nashville Basin and Tennessee River Valley in Tennessee, a few counties in the Piedmont of Georgia and in the upper Coastal Plain of Georgia, Alabama, and Mississippi, two counties in the Delta of Louisiana, the Black Waxy Prairie of Texas, the valleys of California, and the plateau of southeastern Washington, northeastern Oregon, and adjacent section of Idaho. Improved farm land constitutes less than

one-eighth of the total land area along the Gulf and South Atlantic Coasts, in the northern portion of the Lake States, and in most of the West.

NONARABLE LAND.

Map 2 shows the land not in farms in 1910. It is land which no one has thought it worth while trying to make into a farm, or, in certain localities, land which has been in farms and was abandoned. It includes much land scattered throughout the southern and eastern States, most of the land along the Canadian border from Maine to Minnesota, and nearly all the land in large areas of the West—in all, over half of the land area of the country. The question arises, Why is this vast domain unoccupied by farms?

Several conditions must be met in order that land may be adapted to the production of crops. First, in this country, land generally must not be so stony or hilly as to prevent the use of the plow and other farm machinery. Map 3 shows the topography of the United States in a generalized way, and explains that vast areas in the western part of the United States and smaller areas in the Appalachian Mountains of the East are not in farms because of their rough surface. Probably 350,000,000 acres, or nearly one-fifth of the land area of the United States, is too hilly or rough for the successful production of crops. This mountainous or stony land, where the rainfall is sufficient, is adapted to the growth of forests, and where the rainfall is light is grazed by roving flocks of sheep or by cattle.

Secondly, the rainfall must be sufficient for profitable production of crops. Map 4 shows the average annual precipitation (rain, melted snow, sleet, and hail) in the United States, and helps to explain why farms are absent from much of the land level enough for agriculture west of the 100th meridian. Where the average annual precipitation in Montana is less than 12 to 15 inches, or less than 18 inches in eastern Colorado, 20 inches in the Panhandle of Texas, and 25 inches in the lower Rio Grande Valley of Texas, the production of crops without irrigation becomes a precarious business under present conditions. This minimum rainfall requirement for successful crop production ranges from 9 to 30 inches in different parts of the United States according

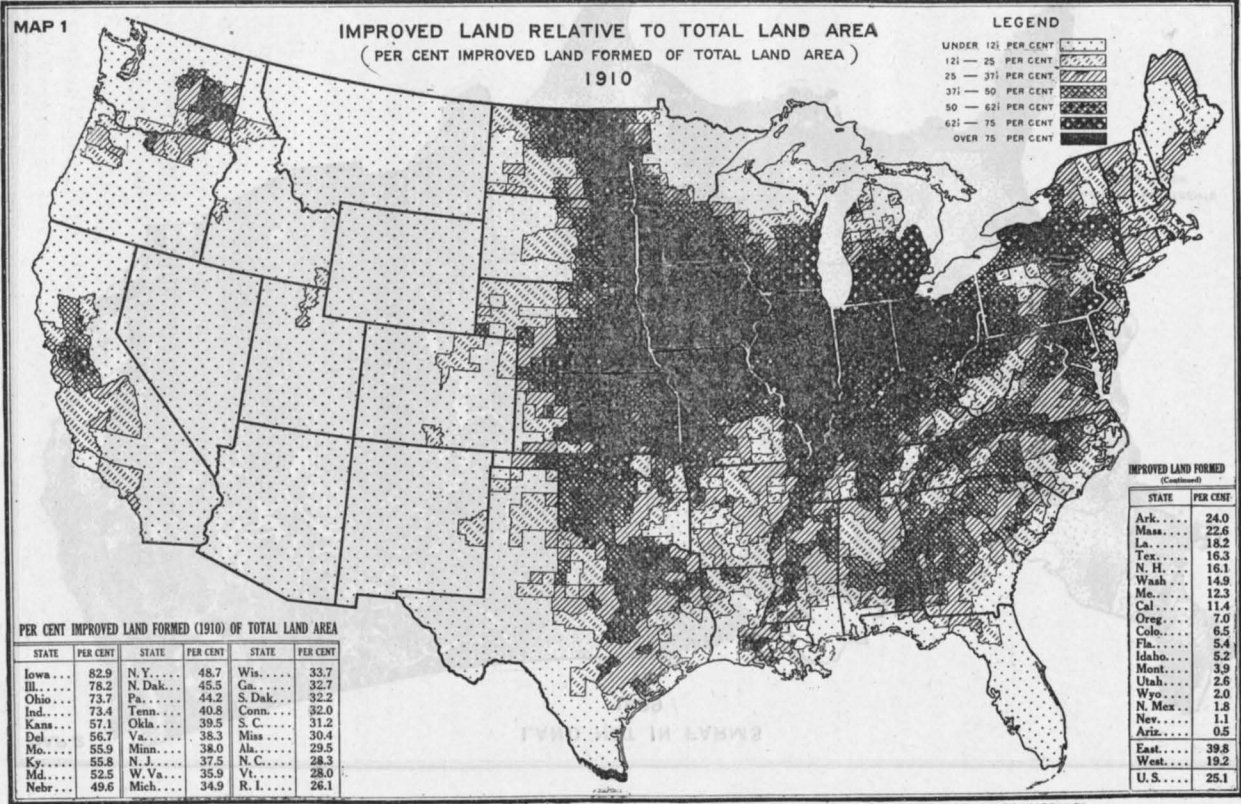

Map 1 shows, by counties, the approximate percentage of the total land area which was improved farm land, April 15, 1910. The statistics, taken from the reports of the Thirteenth Census, afford the latest information available on the subject.

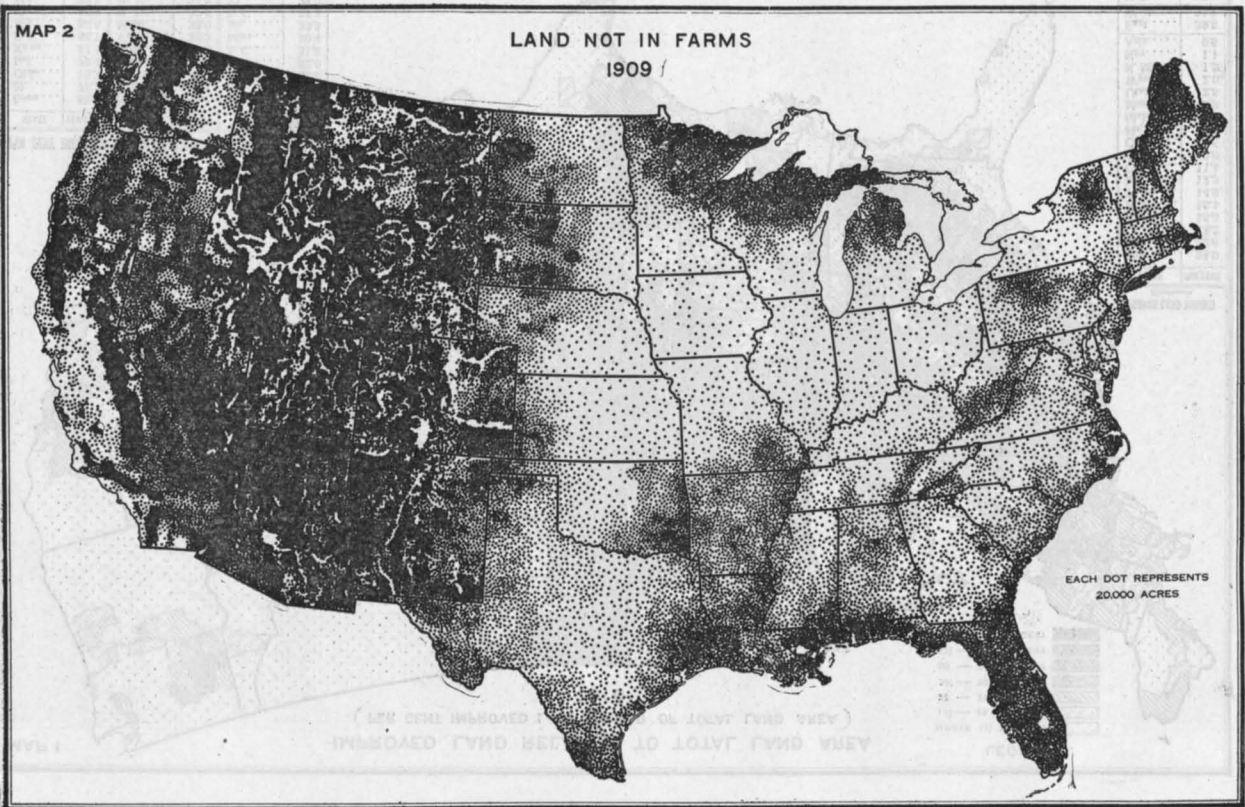

Map 2 shows the location of the land not in farms, April 15, 1910, as reported in the Thirteenth Census. The dots are distributed by counties although, in order to avoid confusion, the county boundaries are not shown on the map. In the West, the dots are distributed within each county according to the location of the unfarmed land.

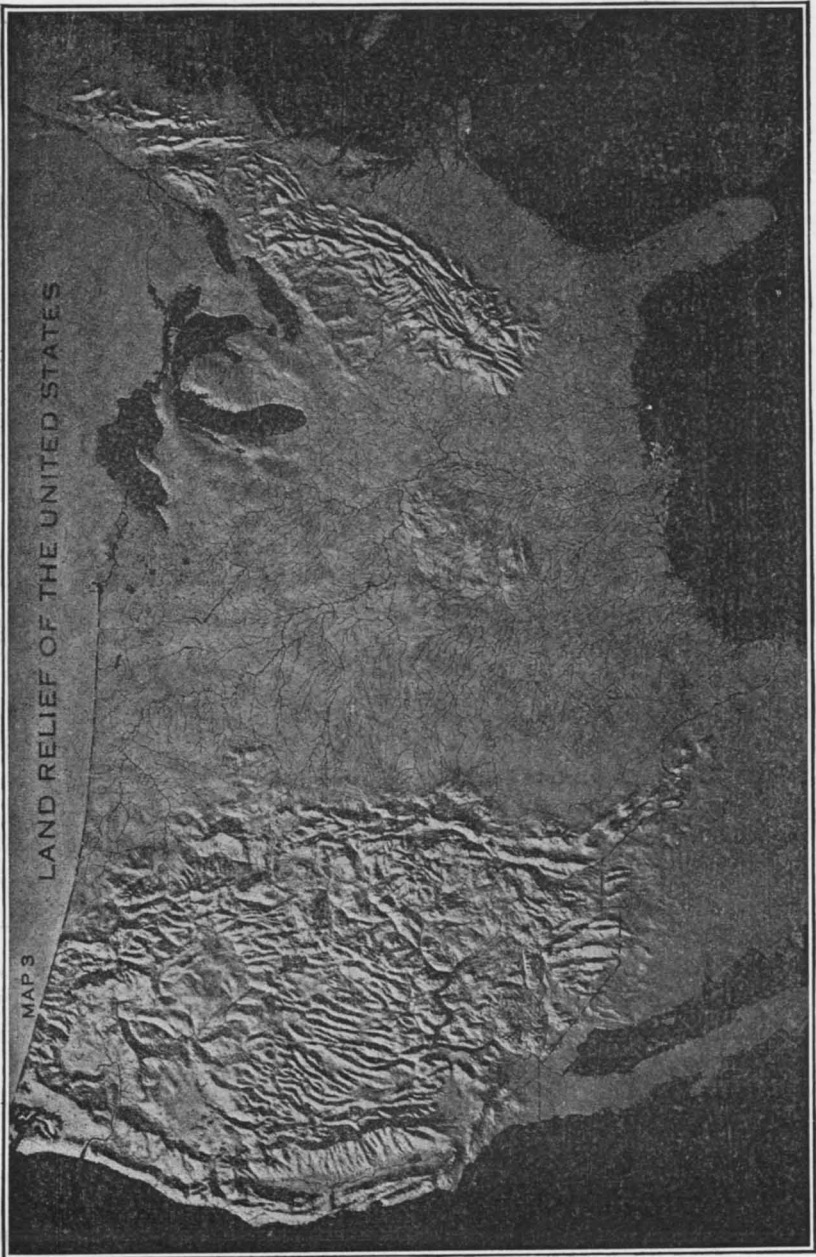

Map 3 shows the topography of the United States in a generalized way. It is a photograph of a relief model of the United States, and was courteously supplied by the U. S. Geological Survey.

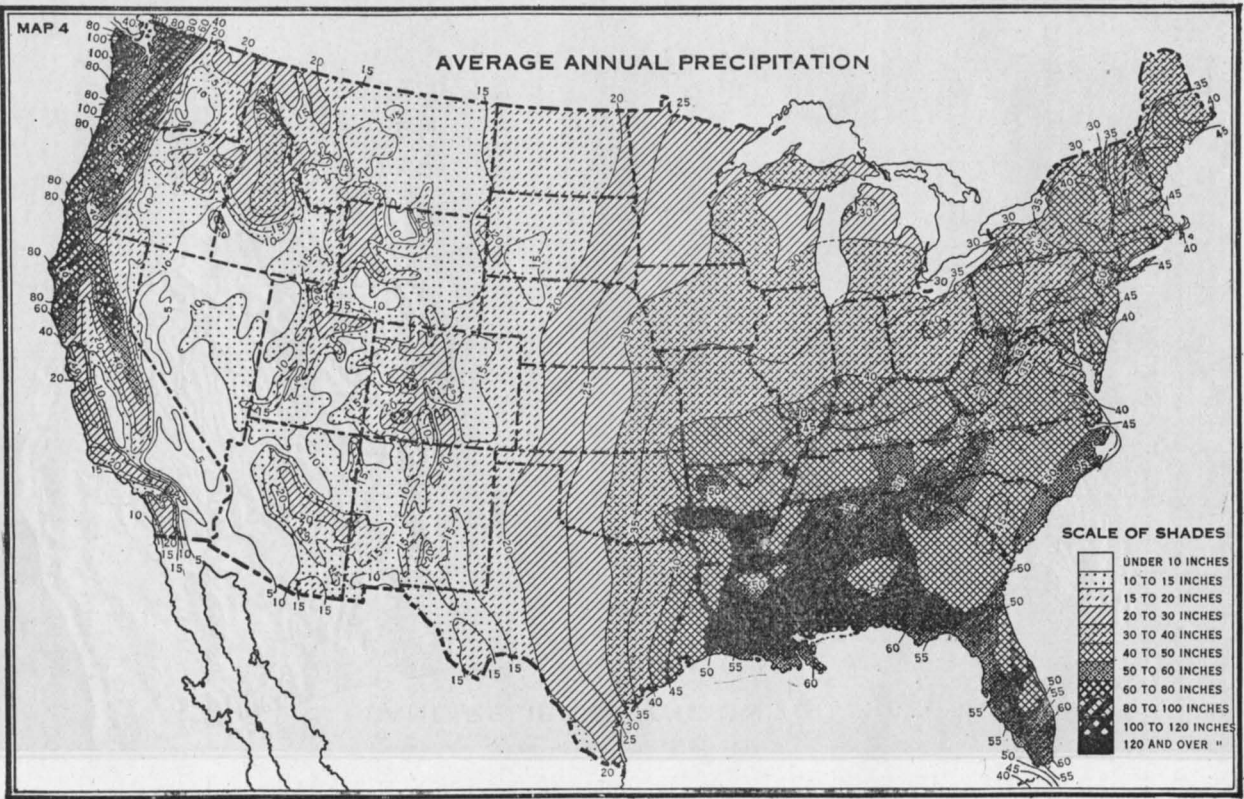

Map 4 shows the average annual precipitation (rain, melted snow, sleet, and hail). It is much reduced and generalized from a map prepared by the U. S. Weather Bureau for publication in the 'Precipitation and Humidity' section of the Atlas of American Agriculture.

to local climatic and soil conditions. In general, it increases from north to south with increasing evaporation and less favorable type and seasonal distribution of precipitation. Probably 600,000,000 acres, or nearly one-third of the land area of the United States, receives insufficient rainfall for the profitable production of crops at normal prices, and possesses no possibilities of irrigation. In occasional years of heavier rainfall, large profits may be made growing crops in these semiarid regions, but in the long run it pays better in most localities to use such land for grazing, and grow only a few acres of crops for supplementary feed in swales and seepage basins.

Thirdly, the amount of heat must be sufficient and the season between killing frosts long enough to mature crops. Map 5, "Length of the Growing Season," shows that over a large extent of elevated land in the West, and also in the Adirondacks and a portion of northern Maine, the average growing season is less than 90 days, and frosts may occur during the summer. Light frosts are not, however, seriously injurious to certain hardy crops, and there is very little area in the United States otherwise suitable for crops where the small amount of heat received or shortness of the growing season prevents the successful production of hay and certain varieties of barley, oats, spring wheat, and potatoes.

Lastly, there are in the United States considerable areas of land where the soil is too sandy or infertile for the profitable production of crops at prevailing prices. Such soils are better adapted to forest, and when cleared for agricultural use are generally soon allowed to grow up again to brush and trees.

In all, about 1,000,000,000 acres, or more than one-half of the land area of the United States, is unfitted for the profitable production of crops, owing either to rough topography, deficient rainfall, low temperature, or infertile soil. This land, except about 40,000,000 acres of absolute desert, is used, though often not as fully as it might be, for the production of wood and timber and for grazing live stock.

POTENTIALLY ARABLE LAND.

In addition to these largely irremediable conditions which limit the expansion of crop area in the United States, there

are other natural conditions amenable to improvement which have retarded agricultural development over large areas.

Map 7 shows the areas of forest and cut-over land suitable for agricultural use where the cost of clearing has retarded utilization. In the northern sections of Michigan, Wisconsin, and Minnesota, and along the North Pacific coast, there is much forest and cut-over land which can be and is being made into farms, but at great expenditure of labor. In the South, from Virginia and the Carolinas to central Texas, a vast amount of cut-over land and woodland is being redeemed gradually for agriculture. It may be estimated that about 200,000,000 acres of forest, "cut-over" land, and woodland in the United States, including that in farms, could be used for crops after clearing, or more than one-tenth of the land area of the country.

If all this agriculturally suitable forest and cut-over land were made into farms averaging 160 acres in size, it would provide 1,250,000 farms, an addition of about 20 per cent to the total number of farms in the country. These wooded areas constitute the greatest unreclaimed agricultural resource of the Nation, but the development of these lands must necessarily be slow, and should be undertaken only by men accustomed to hard labor and willing to endure privation. It is unlikely that more than 50,000,000 acres, or enough for perhaps 300,000 farms, will be cleared by the present generation of farmers, unless the Government assumes responsibility.

The next greatest undeveloped agricultural resource of the country is to be found in the swamps and other wet lands susceptible of drainage. It has been estimated that there are some 60,000,000 acres of such land suitable for the production of crops after reclamation, or enough to make 1,000,000 farms of 60 acres each of improved land. This land, as shown in map 8, is located largely in the Mississippi River bottoms and other river bottoms of the Coastal Plain of the South, and in the peat bogs and muck lands of the glaciated Lake States and Northeastern States. It is for the most part potentially fertile land. But drainage is an expensive operation, often involving cooperative or capitalistic effort, and will require time, very likely a half century or more, for

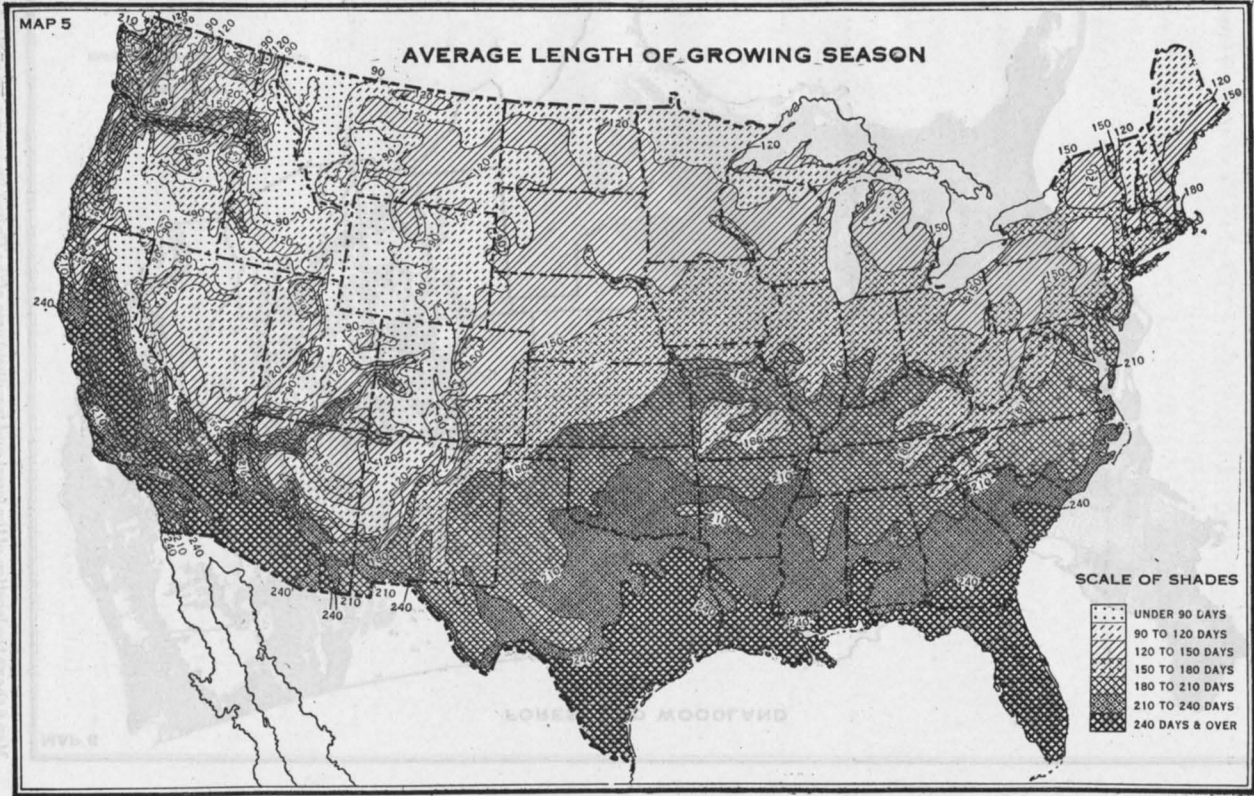

Map 5 shows the average length of the season between killing frosts. It is much reduced and generalized from a map prepared by the U. S. Weather Bureau and published in the Frost and Growing Season section of the Atlas of American Agriculture.

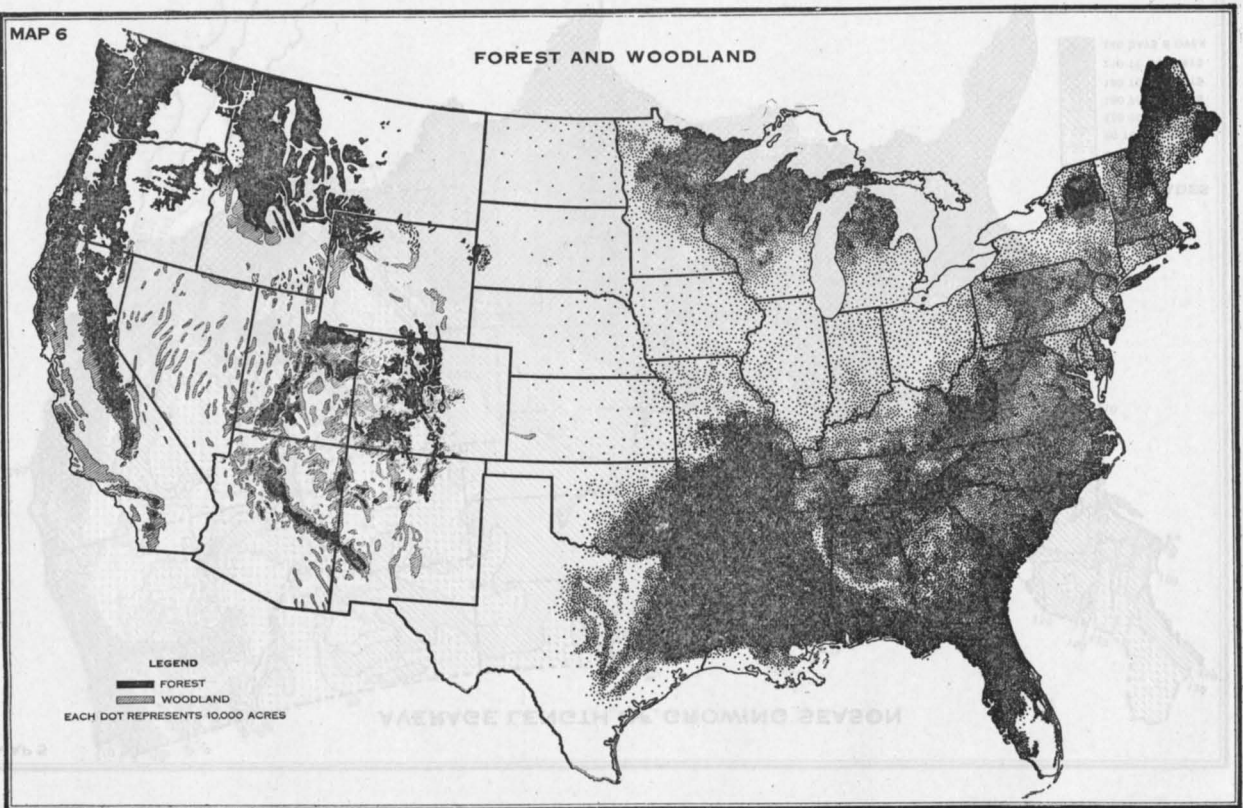

Map 6 shows the location of the forest and woodland area of the United States in a generalized way. It was prepared in cooperation with the Forest Service. In the West, except in Oregon and California, the boundaries of the forests have been taken in part from a map prepared by Henry Gannett and published in the Nineteenth Annual Report of the U. S. Geological Survey. In Oregon and California, maps issued by the State departments of forestry were used.

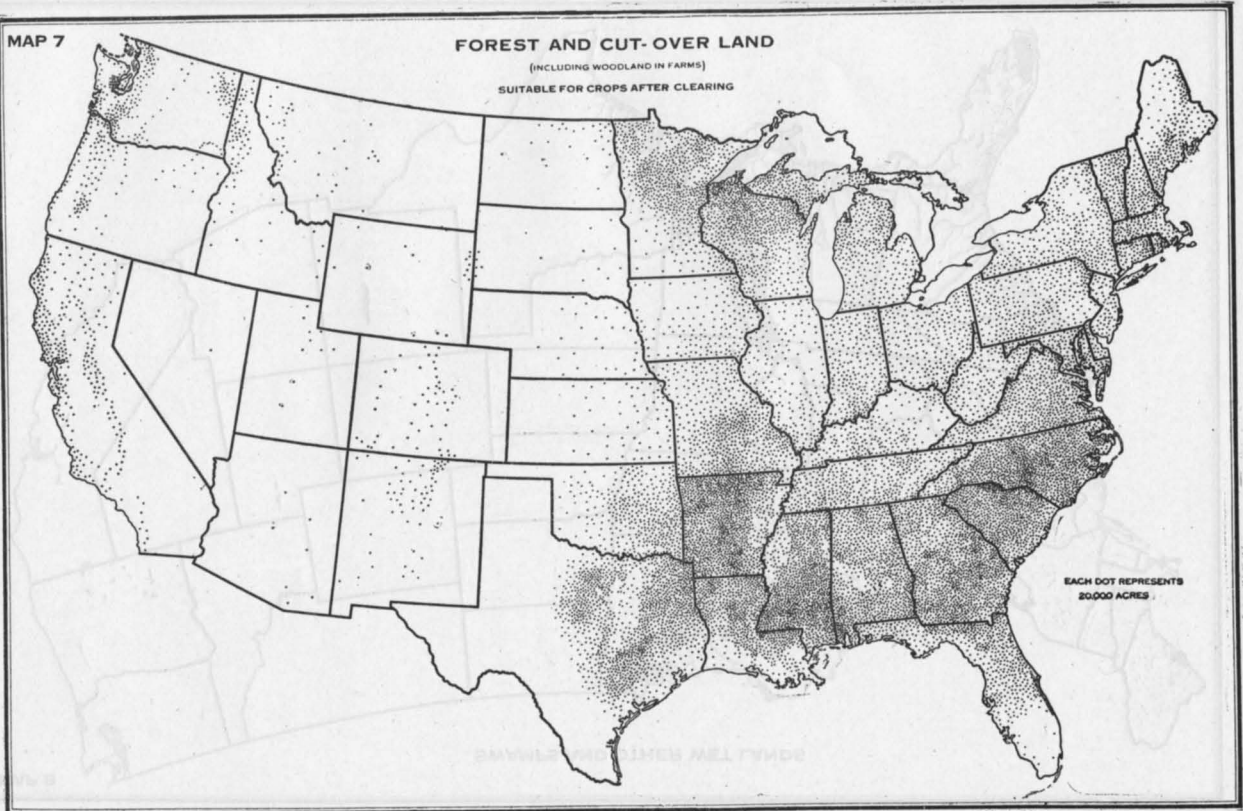

Map 7 shows the approximate location and extent of forest, cut-over land, and woodland which could be used for the production of crops after clearing. Only such part of this land should be cleared, however, as will pay adequate returns on the cost of clearing. The estimates were compiled from Census data, Forest Service reports, and from correspondence with State and county officials and lumber companies.

436-3

98911°—YBK 1918—32



Map 8 shows the location in a generalized way of the swamps and other wet lands susceptible of drainage. In the Southern States it is based on a soil region map prepared by H. H. Bennett, of the Bureau of Soils, and published in the Cotton section of the Atlas of American Agriculture. In the Northern and Western States it is based on Soil Survey and Forest Service reports.

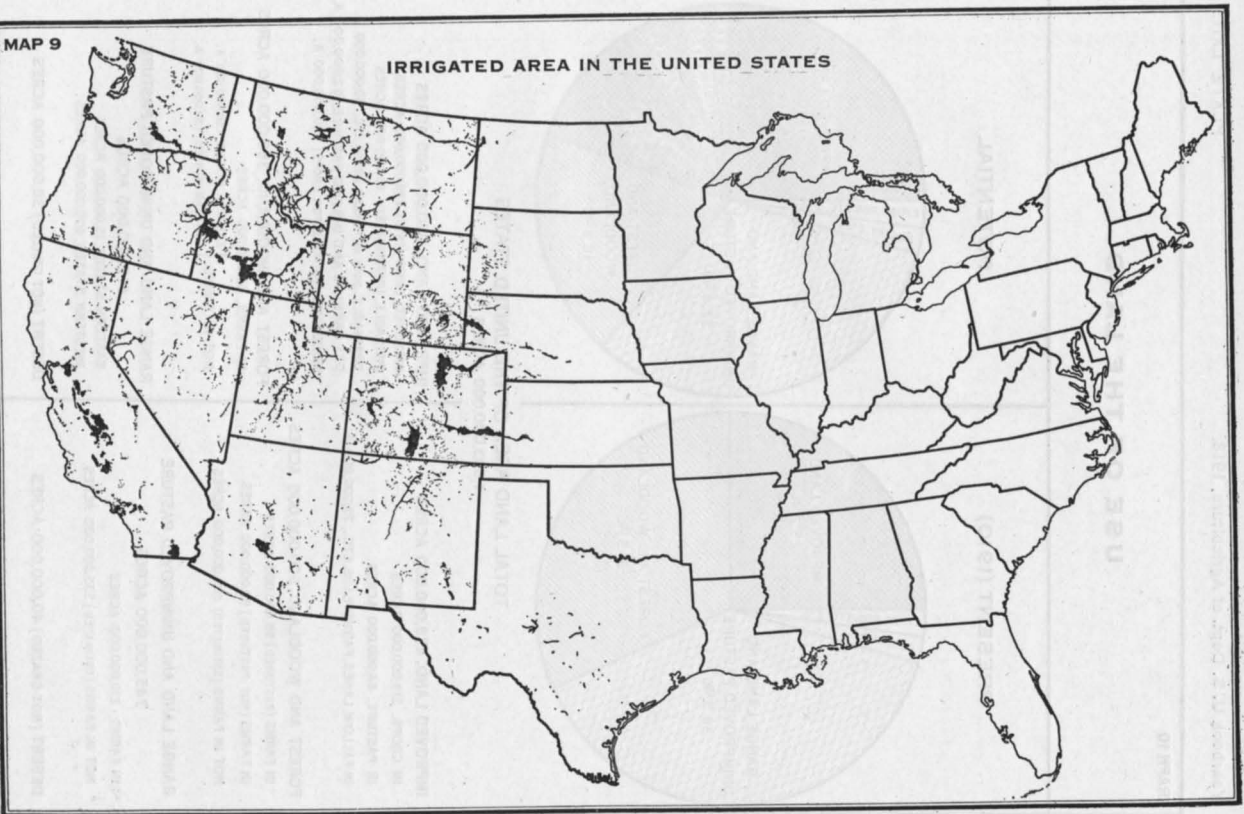

Map 9 shows the location of irrigated areas in the Western States. It is much reduced and generalized from State maps prepared by the Census Bureau and then checked and corrected by the State irrigation engineers upon the request of the Office of Irrigation Investigations, U. S. Department of Agriculture. Most of the areas necessarily have been exaggerated, so that the map presents a picture, sufficiently accurate for a general conception, of the potentially irrigable as well as the present irrigated areas.

GRAPH 10

USE OF THE LAND

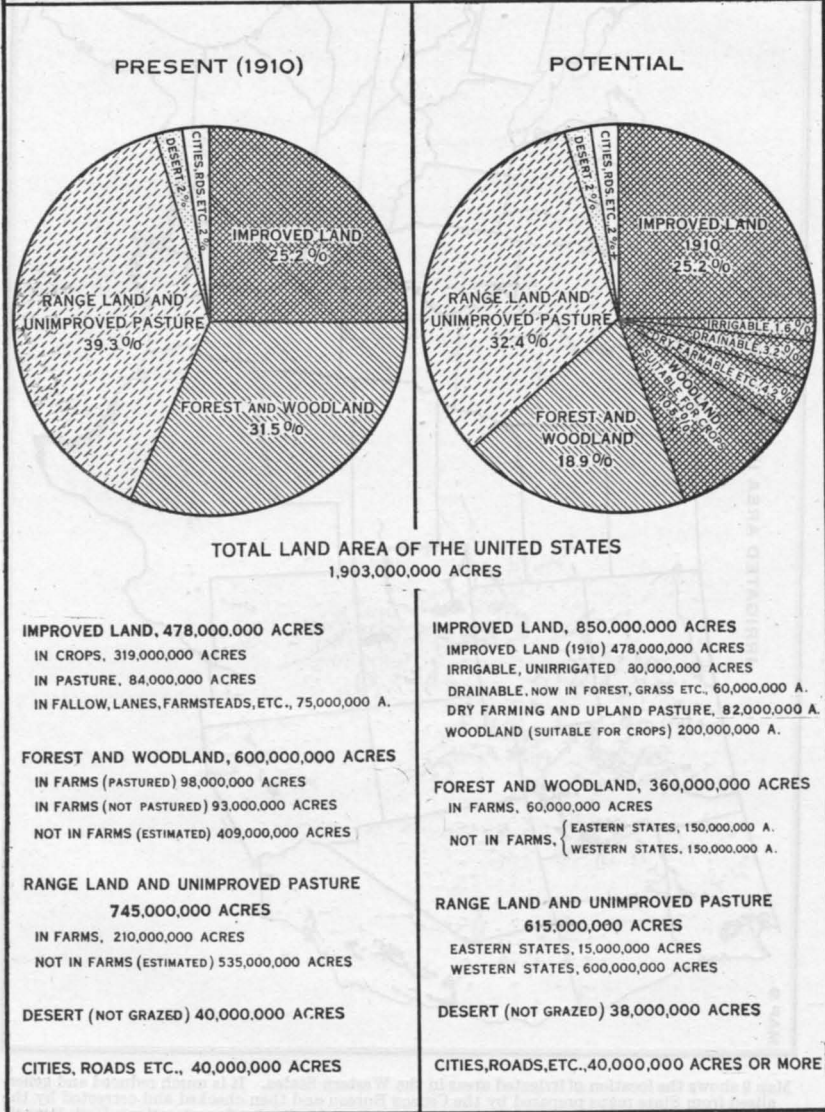

the complete development of the 60,000,000 acres. Practically none of this land is available for settlement at present.

The third opportunity for expansion of our agricultural area is found in the potentially irrigable land awaiting development in the Western States, estimated at 30,000,000 acres if all available sources of water supply were fully utilized (see map 9). This is double the present area of irrigated land, and would provide 340,000 farms averaging 87 acres in size, which is the average acreage per farm of irrigated land as shown by the Census of 1910. But the cost of construction of dams in the mountains and of irrigation canals and ditches is very great and becomes progressively greater as the less favorable projects are developed. At present the supply of land under the ditch and ready for farming in several Federal reclamation projects exceeds the demand at the price quoted, which in many cases includes only the cost of development. It appears likely, therefore, that the development of these potentially irrigable areas will require many years, and in the end will provide fewer farms than either the forest and cut-over lands, or the swamp and overflow lands. In 1910, about 160,000 farms in the Western States were irrigated in whole or in part, and the slight increase since that date has been confined principally to the Federal reclamation projects, upon which there are now (1918) about 27,000 farmers.

A different type of land, some of which will be utilized gradually for the production of crops, is that in our eastern farms classified in the census reports as "unimproved land other than woodland." This land consists largely of unused fields, stony upland pastures in hilly regions, and parcels of waste land, and includes in all about 50,000,000 acres in our humid Eastern States. Some of this land has been in crops in the past, constituting in part the so-called abandoned farms, and if prices of farm products continue high and farm labor again becomes comparatively cheap, a portion of this land will undoubtedly be put into crops, though probably never more than two-thirds, or perhaps 35,000,000 acres.

Finally, the further development of dry farming may make room for a few more farmers in the West. Under the 640 acres grazing homestead act passed in 1916, somewhat over

45,000 applications had been made and approved by October 1, 1918. In the opinion of those best informed, most of these grazing homesteads which afford promise of supporting a family have been applied for.

TOTAL ARABLE LAND.

According to the best information, we have in all about 850,000,000 acres of land at present in crops and potentially available for the production of crops (see Pl. LXII). This is 45 per cent of the total land area of the United States, or about the same proportion the arable land of France is of the total area, and some 5 per cent less than the proportion of the land in Germany that is arable. In view of the fact that these countries have practically no semiarid area, such as covers about one-third of the United States, it seems probable that this estimate of the total arable land of the United States, although smaller than those made heretofore, is too high rather than too low.

Of these 850,000,000 acres, nearly 480,000,000 acres were "improved" in 1910. The remainder consists of about 200,000,000 acres of potentially arable forest and cut-over land, of which probably more than one-half is at present included in the 190,000,000 acres of woodland in farms; 60,000,000 acres of swamps and other wet lands awaiting reclamation by drainage; 30,000,000 acres of potentially irrigable land; and about 80,000,000 acres of other lands, mostly "unimproved land other than woodland" in eastern farms and dry-farming land in the West.

These undeveloped lands may provide eventually about 3,000,000 farms, an increase of somewhat less than 50 per cent over the number of farms in the United States to-day. But unquestionably the better and the best land which it has been possible to develop by individual effort is now "improved" land in farms, and much of that which remains undeveloped must await the gradual application of large amounts of capital to its development, supplied either by private initiative or by the Government.

The 1,000,000,000 acres or more of nonarable land consists of about 360,000,000 acres of absolute forest land; that is, land not adapted to crops but where climatic conditions permit the growth of forests; 615,000,000 acres of grazing land,

practically all in the Western States; and 40,000,000 acres of absolute desert land. In addition, there are about 40,000,000 acres of land at present in cities, rural highways, and railroad rights of way, an amount which will gradually increase with increasing population.

ECONOMIC ASPECTS.

All these estimates refer merely to the potential fitness of the land for agriculture, and do not take into account economic aspects of the subject. It may be found, for instance, that 360,000,000 acres of forest will not be sufficient to supply the needs of the Nation for forest products, and that some of the lower grades of potentially arable land can be more profitably utilized for the production of timber. In fact, assuming that the annual per capita consumption of forest products will gradually decrease to half that at present, a very conservative estimate, and allowing a very liberal estimate of the rate of growth of forests under intensive management (33 cubic feet per acre per annum), the country will require a woodland area of at least 450 million acres for a population of 150 million people. It does not seem likely, therefore, that the forest area will ever be reduced to 360 million acres, but that there always will be considerable potentially arable land, mostly of poor quality, in forest, as is the case in the well-developed countries of Europe to-day. Similarly it is practically certain that an appreciable proportion of the land suitable for crops will be kept in pasture. At present the ratio of improved pasture to cropped land in the United States is about one to four, and in many older and more highly developed agricultural regions, especially those of England and northern France, the proportion in pasture is much greater.

Also it should be kept in mind that probably half of the 370,000,000 acres of reclaimable arable land is at present in farms, and that most of this land in farms is unlikely to need the assistance of the Government in its reclamation. Farmers who live in forested regions commonly clear off a few acres of timber each winter, and some who have poorly drained meadows or fields put in a few lines of tile each year. In this way, and also by plowing up pasture lands for crops, the area in staple crops increased 37,000,000 acres be-

tween 1914 and 1918, according to a recent estimate of the Bureau of Crop Estimates, an increase of nearly 10 per cent, which is much greater than the percentage increase in the population of the Nation. This 4-year increase in acreage of the staple crops is equivalent to the acreage of all crops in 1910 in the New England States, New York, Pennsylvania, New Jersey, Delaware, Maryland, West Virginia, Virginia, and North Carolina.

Increased production of agricultural products may also be expected to come from more intensive farming. The yields per acre of the staple crops, with the possible exception of corn, have shown a general tendency upward during the last 25 years.

Yield per acre of 6 leading food crops in the United States, five-year averages for 1866-1870 to 1900-1915.

[Compiled from reports of Bureau of Crop Estimates, United States Department of Agriculture.]

Years.	Corn.	Wheat.	Oats.	Barley.	Potatoes.	Rye.
	<i>Bushels.</i>	<i>Bushels.</i>	<i>Bushels.</i>	<i>Bushels.</i>	<i>Bushels.</i>	<i>Bushels.</i>
1866-1870.....	25.4	11.9	28.6	24.3	94.4	13.5
1871-1875.....	26.8	11.9	28.1	21.5	91.5	13.6
1876-1880.....	27.1	12.9	27.6	22.7	85.3	13.9
1881-1885.....	23.6	11.8	26.8	21.7	77.2	11.9
1886-1890.....	23.7	12.1	25.2	21.8	68.7	11.7
1891-1895.....	23.6	13.4	26.2	23.4	77.7	13.7
1896-1900.....	26.0	13.2	28.6	23.4	81.0	14.5
1901-1905.....	24.9	13.9	31.0	27.0	88.7	15.9
1906-1910.....	27.2	14.6	28.0	24.4	96.6	15.8
1911-1915.....	26.0	15.4	31.7	26.5	98.1	16.5

High prices of agricultural products result in improved methods and increasing intensity of culture, as well as in making possible the cultivation of less desirable lands. Both methods of increasing production should be and will be used; but in many cases the application of more capital and labor to land now in use will bring greater returns than the use of the same capital and labor in the development of new lands.

It appears probable, therefore, that the area in crops will never reach the estimated possible total of 850 million acres, but that with increasing cost of reclamation, the trend will be toward more intensive cultivation of the more fertile or

favorably situated land and use of the lower grades of arable land for grazing or production of timber. This trend is illustrated in the Northeastern States by the well-cultivated lowlands and the so-called abandoned farms in the highlands. Farms close to good markets can be bought in these States for less than the cost of the buildings. In the densely populated and highly developed countries of northwestern Europe, where an approximately stationary condition has been reached, about half the land area is arable, whereas in the humid portion of the United States about 38 per cent of the land area is "improved"—using the terminology of the Census. As geographic conditions in so far as they relate to the potential utilization of land in the two regions are somewhat similar, it may be anticipated that when the population of the United States becomes as dense as that of northwestern Europe the improved land will be about half of the humid area of the Nation, or 600 to 700 million acres.



APPENDIX.

AGRICULTURAL COLLEGES IN THE UNITED STATES.¹

College instruction in agriculture is given in the colleges and universities receiving the benefits of the acts of Congress of July 2, 1862, August 30, 1890, and March 4, 1907, which are now in operation in all the States and Territories except Alaska. The total number of these institutions is 69, of which 67 maintain courses of instruction in agriculture. In 23 States and Porto Rico the agricultural colleges are departments of the State universities. In 17 States separate institutions having courses in agriculture are maintained for the colored race. All of the agricultural colleges for white persons and several of those for negroes offer four-year courses in agriculture and its related sciences leading to bachelor's degrees, and many provide for graduate study. About 60 of these institutions also provide special, short, or correspondence courses in the different branches of agriculture, including agronomy, horticulture, animal husbandry, poultry raising, cheese making, dairying, sugar making, rural engineering, farm mechanics, and other technical subjects. The agricultural experiment stations, with very few exceptions, are departments of the agricultural colleges. It is estimated that the total number of persons engaged in the work of education and research in the land-grant colleges and the experiment stations in 1918 was 10,924; the number of students (white) in interior courses in the colleges of agriculture and mechanic arts, 70,195; the total number of students (white) in the whole institutions, 111,267;² the number of students (white) in the four-year college courses in agriculture, 9,574; the total number of students in the institutions for negroes, 9,149, of whom 2,820 were enrolled in agricultural courses. With a few exceptions, each of these colleges offers free tuition to residents of the State in which it is located. In the excepted cases scholarships are open to promising and energetic students, and in all opportunities are found for some to earn part of their expenses by their own labor. The expenses are from \$125 to \$300 for the school year.

Agricultural colleges in the United States.

State or Territory.	Name of institution.	Location.	President.
Alabama.....	Alabama Polytechnic Institute.....	Auburn.....	C. C. Thach.
	Agricultural School of the Tuskegee Normal and Industrial Institute.	Tuskegee Institute..	R. R. Moton. ³
	Agricultural and Mechanical College for Negroes.	Normal.....	W. S. Buchanan.
Arizona.....	College of Agriculture of the University of Arizona.	Tucson.....	D. W. Working. ⁴
Arkansas.....	College of Agriculture of the University of Arkansas.	Fayetteville.....	Martin Nelson. ⁴
California.....	Branch Normal College.....	Pine Bluff.....	J. G. Ish, jr.
	College of Agriculture of the University of California.	Berkeley.....	T. F. Hunt. ⁴
Colorado.....	The State Agricultural College of Colorado.	Fort Collins.....	C. A. Lory.
Connecticut.....	Connecticut Agricultural College.....	Storrs.....	C. L. Beach.
Delaware.....	Delaware College.....	Newark.....	S. C. Mitchell.
	State College for Colored Students.	Dover.....	W. C. Jason.
Florida.....	College of Agriculture of the University of Florida.	Gaineville.....	P. H. Rolfs. ⁴
	Florida Agricultural and Mechanical College for Negroes.	Tallahassee.....	N. B. Young.

¹ Including only institutions established under the land-grant act of July 2, 1862.

² Not including students in correspondence courses and extension schools.

³ Principal.

⁴ Dean.

Agricultural colleges in the United States—Continued.

State or Territory.	Name of institution.	Location.	President.
Georgia.....	Georgia State College of Agriculture.....	Athens.....	A. M. Soule.
	Georgia State Industrial College.....	Savannah.....	R. R. Wright.
Hawaii.....	College of Hawaii.....	Honolulu.....	A. L. Dean.
Idaho.....	College of Agriculture of the University of Idaho.	Moscow.....	E. J. Iddings. ¹
Illinois.....	College of Agriculture of the University of Illinois.	Urbana.....	E. Davenport. ¹
Indiana.....	School of Agriculture of Purdue University.	La Fayette.....	J. H. Skinner. ¹
Iowa.....	Iowa State College of Agriculture and Mechanic Arts.	Ames.....	R. A. Pearson.
Kansas.....	Kansas State Agricultural College.....	Manhattan.....	W. M. Jardine.
Kentucky.....	The College of Agriculture of the University of Kentucky.	Lexington.....	T. P. Cooper. ¹
	The Kentucky Normal and Industrial Institute for Colored Persons.	Frankfort.....	G. P. Russell.
Louisiana.....	Louisiana State University and Agricultural and Mechanical College.	Baton Rouge.....	T. D. Boyd.
	Southern University and Agricultural and Mechanical College of the State of Louisiana.	Scotland Heights, Baton Rouge.	J. S. Clark.
Maine.....	College of Agriculture of the University of Maine.	Orono.....	L. S. Merrill. ¹
Maryland.....	Maryland State College of Agriculture... Princess Anne Academy, Eastern Branch of the Maryland State College of Agriculture.	College Park..... Princess Anne.....	A. F. Woods. T. H. Kiah. ²
Massachusetts.....	Massachusetts Agricultural College.....	Amherst.....	K. L. Butterfield.
	Massachusetts Institute of Technology. ³	Boston.....	R. C. Maclaurin.
Michigan.....	Michigan Agricultural College.....	East Lansing.....	F. S. Kedzie.
Minnesota.....	Department of Agriculture of the University of Minnesota.	University Farm, St. Paul.	R. W. Thatcher. ¹
Mississippi.....	Mississippi Agricultural and Mechanical College.	Agricultural College.	W. H. Smith.
	Alcorn Agricultural and Mechanical College.	Alcorn.....	L. J. Rowan.
Missouri.....	College of Agriculture of the University of Missouri.	Columbia.....	F. B. Mumford. ¹
	School of Mines and Metallurgy of the University of Missouri. ³	Rolla.....	_____
	Lincoln Institute.....	Jefferson City.....	Clement Richardson.
Montana.....	Montana State College of Agriculture and Mechanic Arts.	Bozeman.....	Jas. M. Hamilton.
Nebraska.....	College of Agriculture of the University of Nebraska.	Lincoln.....	E. A. Burnett. ¹
Nevada.....	College of Agriculture of the University of Nevada.	Reno.....	C. S. Knight. ¹
New Hampshire.....	New Hampshire College of Agriculture and the Mechanic Arts.	Durham.....	R. D. Hetzel.
New Jersey.....	State College of Agriculture and Mechanic Arts of Rutgers College and the State University of New Jersey.	New Brunswick.....	W. H. S. Demarest.
New Mexico.....	New Mexico College of Agriculture and Mechanic Arts.	State College.....	A. D. Crile.
New York.....	New York State College of Agriculture...	Ithaca.....	A. R. Mann. ¹
North Carolina.....	The North Carolina State College of Agriculture and Engineering.	West Raleigh.....	W. C. Riddick.
	Negro Agricultural and Technical College.	Greensboro.....	J. B. Dudley.
North Dakota.....	North Dakota Agricultural College.....	Agricultural College.	E. F. Ladd.
Ohio.....	College of Agriculture of Ohio State University.	Columbus.....	Alfred Vivian. ¹
Oklahoma.....	Oklahoma Agricultural and Mechanical College.	Stillwater.....	J. W. Cantwell.
	Agricultural and Normal University.....	Langston.....	J. M. Marquess.
Oregon.....	Oregon Agricultural College.....	Corvallis.....	W. J. Kerr.
Pennsylvania.....	The School of Agriculture of the Pennsylvania State College.	State College.....	R. L. Watts. ¹
Porto Rico.....	College of Agriculture and Mechanic Arts of the University of Porto Rico.	Mayaguez.....	R. S. Garwood. ¹
Rhode Island.....	Rhode Island State College.....	Kingston.....	Howard Edwards.
South Carolina.....	The Clemson Agricultural College of South Carolina.	Clemson College.....	W. M. Riggs.
	State Agricultural and Mechanical College of South Carolina.	Orangeburg.....	R. S. Wilkinson.
South Dakota.....	South Dakota State College of Agriculture and Mechanic Arts.	Brookings.....	W. E. Johnson.
Tennessee.....	College of Agriculture, University of Tennessee.	Knoxville.....	H. A. Morgan. ¹
	Tennessee Agricultural and Industrial State Normal School.	Nashville.....	W. J. Hale.

¹ Dean.² Principal.³ Does not maintain courses in agriculture.

Agricultural colleges in the United States—Continued.

State or Territory.	Name of institution.	Location.	President.
Texas.....	Agricultural and Mechanical College of Texas. Prairie View State Normal and Industrial College.	College Station..... Prairie View.....	W. B. Bizzell. J. G. Osborne. ¹
Utah.....	The Agricultural College of Utah.....	Logan.....	E. G. Peterson.
Vermont.....	College of Agriculture of the University of Vermont.	Burlington.....	J. L. Hills. ²
Virginia.....	The Virginia Agricultural and Mechanical College and Polytechnic Institute. The Hampton Normal and Agricultural Institute.	Blacksburg..... Hampton.....	J. D. Eggleston. J. E. Gregg. ¹
Washington.....	State College of Washington.....	Pullman.....	E. O. Holland.
West Virginia.....	College of Agriculture of West Virginia University.	Morgantown.....	J. L. Coulter. ²
Wisconsin.....	The West Virginia Collegiate Institute... College of Agriculture of the University of Wisconsin.	Institute..... Madison.....	Byrd Prillerman. H. L. Russell. ²
Wyoming.....	College of Agriculture, University of Wyoming.	Laramie.....	A. D. Faville. ²

¹ Principal.

² Dean.

AGRICULTURAL EXPERIMENT STATIONS.

Alabama (College), Auburn: J. F. Duggar.
 Alabama (Canebrake), Uniontown: J. M. Burgess.
 Alabama (Tuskegee), Tuskegee Institute: G. W. Carver.
 Alaska, Sitka (Rampart, Kodiak, Fairbanks, and Matanuska): C. C. Georgeson.¹
 Arizona, Tucson: D. W. Working.
 Arkansas, Fayetteville: Martin Nelson.
 California, Berkeley: T. F. Hunt.
 Colorado, Fort Collins: C. P. Gillette.
 Connecticut (State), New Haven } E. H. Jenkins.
 Connecticut (Storrs), Storrs }
 Delaware, Newark: Harry Hayward.
 Florida, Gainesville: P. H. Royfs.
 Georgia, Experiment: H. P. Stuckey.
 Guam.² C. W. Edwards.³
 Hawaii (Federal), Honolulu: J. M. Westgate.¹
 Hawaii (Sugar Planters'), Honolulu: H. P. Agee.
 Idaho, Moscow: E. J. Iddings.
 Illinois, Urbana: E. Davenport.
 Indiana, La Fayette: C. G. Woodbury.
 Iowa, Ames: C. F. Curtiss.
 Kansas, Manhattan: F. D. Farrell.
 Kentucky, Lexington: T. P. Cooper.
 Louisiana (State), Baton Rouge } W. R. Dodson.
 Louisiana (Sugar), New Orleans }
 Louisiana (North), Calhoun }
 Louisiana (Rice), Crowley }
 Maine, Orono: C. D. Woods.
 Maryland, College Park: H. J. Patterson.
 Massachusetts, Amherst: F. W. Morse.⁴
 Michigan, East Lansing: R. S. Shaw.
 Minnesota, University Farm, St. Paul: R. W. Thatcher.
 Mississippi, Agricultural College: J. R. Ricks.
 Missouri (College), Columbia: F. B. Mumford.
 Missouri (Fruit), Mountain Grove: F. W. Faurot.
 Montana, Bozeman: F. B. Linfield.
 Nebraska, Lincoln: E. A. Burnett.
 Nevada, Reno: S. B. Doten.
 New Hampshire, Durham: J. C. Kendall.
 New Jersey (College), New Brunswick } J. G. Lipman.
 New Jersey (State), New Brunswick }
 New Mexico, State College: Fabian Garcia.
 New York (State), Geneva: W. H. Jordan.
 New York (Cornell), Ithaca: A. R. Mann.
 North Carolina, Raleigh and West Raleigh: B. W. Kilgore.
 North Dakota, Agricultural College: P. F. Trowbridge.
 Ohio, Wooster: C. E. Thorne.
 Oklahoma, Stillwater: H. G. Knight.
 Oregon, Corvallis: A. B. Cordley.
 Pennsylvania, State College: R. L. Watts.
 Pennsylvania (Institute of Animal Nutrition), State College: H. P. Armsby.
 Porto Rico (Federal), Mayaguez: D. W. May.⁵
 Porto Rico (Insular), Rio Piedras: E. Colón.
 Rhode Island, Kingston: B. L. Hartwell.
 South Carolina, Clemson College: H. W. Barre.
 South Dakota, Brookings: J. W. Wilson.
 Tennessee, Knoxville: H. A. Morgan.
 Texas, College Station: B. Youngblood.
 Utah, Logan: F. S. Harris.
 Vermont, Burlington: J. L. Hills.
 Virginia (College), Blacksburg: A. W. Drinkard, jr.
 Virginia (Truck), Norfolk: T. C. Johnson.
 Virgin Islands, St. Croix: Longfield Smith.¹
 Washington, Pullman: E. C. Johnson.
 West Virginia, Morgantown: J. L. Coulter.
 Wisconsin, Madison: H. L. Russell.
 Wyoming, Laramie: A. D. Faville.

STATE OFFICIALS IN CHARGE OF AGRICULTURE.

Alabama: Commissioner of Agriculture, Montgomery.
 Arizona: Secretary of State, Phoenix.
 Arkansas: Commissioner of Bureau of Mines, Manufactures, and Agriculture, Little Rock.
 California: Secretary of the California State Agricultural Society, Sacramento.
 Colorado: Secretary of the State Board of Agriculture, Fort Collins.
 Connecticut: Secretary of State Board of Agriculture, Hartford.
 Delaware: Secretary of State Board of Agriculture, Dover.

¹ Agronomist in charge.

² Address: Island of Guam, via San Francisco.

³ Animal husbandman in charge.

⁴ Acting director.

- Florida: Commissioner of Agriculture, Tallahassee.
 Georgia: Commissioner of Agriculture, Atlanta.
 Hawaii: Secretary of Territorial Board of Agriculture, Honolulu.
 Idaho: Superintendent of Department of Farm Markets, Boise.
 Illinois: Director of Department of Agriculture, Springfield.
 Indiana: Secretary of State Board of Agriculture, Indianapolis.
 Iowa: Secretary of Department of Agriculture, Des Moines.
 Kansas: Secretary of State Board of Agriculture, Topeka.
 Kentucky: Commissioner of Agriculture, Frankfort.
 Louisiana: Commissioner of Agriculture and Immigration, Baton Rouge.
 Maine: Commissioner of Agriculture, Augusta.
 Maryland: Secretary of State Board of Agriculture, Kensington.
 Massachusetts: Secretary of State Board of Agriculture, Boston.
 Michigan: Secretary of State Board of Agriculture, East Lansing.
 Minnesota: Secretary of State, St. Paul.
 Mississippi: Commissioner of Agriculture and Commerce, Jackson.
 Missouri: Secretary of State Board of Agriculture, Jefferson City.
 Montana: Commissioner of Agriculture and Publicity, Helena.
 Nebraska: Secretary of State Board of Agriculture, Lincoln.
 Nevada: Secretary of State, Carson City.
 New Hampshire: Commissioner of Agriculture, Concord.
 New Jersey: Secretary of Department of Agriculture, Trenton.
 New Mexico: State Land Commissioner, Santa Fe.
 New York: Commissioner of Agriculture, Albany.
 North Carolina: Commissioner of Agriculture, Raleigh.
 North Dakota: Commissioner of Agriculture and Labor, Bismarck.
 Ohio: Secretary of State Board of Agriculture, Columbus.
 Oklahoma: Commissioner of Agriculture, Oklahoma.
 Oregon: Secretary of State Board of Agriculture, Salem.
 Pennsylvania: Secretary of Department of Agriculture, Harrisburg.
 Philippine Islands: Director of Agriculture, Manila.
 Porto Rico: Commissioner of Agriculture and Labor, San Juan.
 Rhode Island: Secretary of State Board of Agriculture, Providence.
 South Carolina: Commissioner of Agriculture, Commerce, and Industries, Columbia.
 South Dakota: Commissioner of Immigration, Pierre.
 Tennessee: Commissioner of Agriculture, Nashville.
 Texas: Commissioner of Agriculture, Austin.
 Utah: Secretary of State, Salt Lake City.
 Vermont: Commissioner of Agriculture, St. Albans.
 Virginia: Commissioner of Agriculture and Immigration, Richmond.
 Washington: Commissioner of Agriculture, Olympia.
 West Virginia: Commissioner of Agriculture, Charleston.
 Wisconsin: Commissioner of Agriculture, Madison.
 Wyoming: Secretary of State, Cheyenne.

STATE OFFICERS IN CHARGE OF COOPERATIVE AGRICULTURAL EXTENSION WORK.

- Alabama: J. F. Dugger, Alabama Polytechnic Institute, Auburn.
 Arizona: E. P. Taylor, College of Agriculture, University of Arizona, Tucson.
 Arkansas: W. C. Lassetter, College of Agriculture, University of Arkansas, Fayetteville.
 California: W. T. Clarke, College of Agriculture, University of California, Berkeley.
 Colorado: H. T. French, State Agricultural College of Colorado, Fort Collins.
 Connecticut: H. J. Baker, Connecticut Agricultural College, Storrs.
 Delaware: H. Hayward, Delaware College, Newark.
 Florida: P. H. Rolfs, College of Agriculture, University of Florida, Gainesville.
 Georgia: J. Phil Campbell, Georgia State College of Agriculture, Athens.
 Idaho: L. W. Fluharty, The Statehouse, Boise.
 Illinois: W. F. Handschin, College of Agriculture, University of Illinois, Urbana.
 Indiana: G. I. Christie, Purdue University, La Fayette.
 Iowa: R. K. Bliss, Iowa State College of Agriculture and Mechanic Arts, Ames.
 Kansas: Harry Umberger,¹ Kansas State Agricultural College, Manhattan.
 Kentucky: Fred Mutchler, College of Agriculture of the University of Kentucky, Lexington.
 Louisiana: W. R. Perkins, Louisiana State University and Agricultural and Mechanical College, Baton Rouge.
 Maine: L. S. Merrill, College of Agriculture, University of Maine, Orono.
 Maryland: T. B. Symons, Maryland State College of Agriculture, College Park.
 Massachusetts: R. W. Redman,¹ Massachusetts Agricultural College, Amherst.
 Michigan: R. J. Baldwin, Michigan Agricultural College, East Lansing.
 Minnesota: A. D. Wilson, College of Agriculture, University of Minnesota, University Farm, St. Paul.
 Mississippi: R. S. Wilson, Mississippi Agricultural and Mechanical College, Agricultural College.
 Missouri: A. J. Meyer, College of Agriculture, University of Missouri, Columbia.
 Montana: F. S. Cooley, Montana State College of Agriculture and Mechanic Arts, Bozeman.
 Nebraska: W. H. Brokaw, College of Agriculture, University of Nebraska, Lincoln.
 Nevada: C. A. Norcross, College of Agriculture, University of Nevada, Reno.
 New Hampshire: J. C. Kendall, New Hampshire College of Agriculture and Mechanic Arts, Durham.
 New Jersey: L. A. Clinton, Rutgers College and the State University of New Jersey, New Brunswick.
 New Mexico: A. C. Cooley, New Mexico College of Agriculture and Mechanic Arts, State College.
 New York: A. R. Mann, New York State College of Agriculture, Ithaca.
 North Carolina: B. W. Kilgore, North Carolina State College of Agriculture and Engineering, West Raleigh.
 North Dakota: G. W. Randlett, North Dakota Agricultural College, Agricultural College.

¹ Acting director.

Ohio: C. S. Wheeler, College of Agriculture, Ohio State University, Columbus.
Oklahoma: J. A. Wilson, Oklahoma Agricultural and Mechanical College, Stillwater.
Oregon: O. D. Center, Oregon Agricultural College, Corvallis.
Pennsylvania: M. S. McDowell, Pennsylvania State College, State College.
Rhode Island: A. E. Stene, Rhode Island State College, Kingston.
South Carolina: W. W. Long, Clemson Agricultural College of South Carolina, Clemson College.
South Dakota: C. Larsen, South Dakota State College, Brookings.
Tennessee: C. A. Keffer, College of Agriculture, University of Tennessee, Knoxville.

Texas: Clarence Ousley, Agricultural and Mechanical College of Texas, College Station.
Utah: J. T. Caine, 3d, Agricultural College of Utah, Logan.
Vermont: Thos. Bradlee, University of Vermont and State Agricultural College, Burlington.
Virginia: J. M. Jones, Virginia Polytechnic Institute, Blacksburg.
Washington: W. S. Thornber, State College of Washington, Pullman.
West Virginia: N. T. Frame,¹ College of Agriculture, West Virginia University, Morgantown.
Wisconsin: K. L. Hatch, College of Agriculture, University of Wisconsin, Madison.
Wyoming: A. E. Bowman, College of Agriculture, University of Wyoming, Laramie.

¹ Acting director.

LIVE STOCK ASSOCIATIONS.

INTERNATIONAL ASSOCIATIONS.

Name of association.	President.	Address.	Secretary.	Address.
Certified Milk Producers' Association.....	James O. Jordan.....	State House, Boston, Mass....	Ivan C. Weld.....	1120 Connecticut Avenue, Wash- ington, D. C.
International Association of Dairy and Milk Inspectors...	Wilson H. Lee.....	Orange, Conn.....	Harry B. Winters.....	Albany, N. Y.
International Milk Dealers' Association.....	John Le Feber.....	Gridley Dairy Co., Milwaukee, Wis.	S. O. Dungan.....	The Polk Sanitary Milk Co., Indianapolis, Ind.

NATIONAL ASSOCIATIONS.

American National Live Stock Association.....	I. T. Pryor.....	San Antonio, Tex.....	T. W. Tomlinson.....	515 Cooper Building, Denver, Colo.
National Dairy Union.....	N. P. Hull.....	Dimondale, Mich.....	W. T. Creasy.....	Catawissa, Pa.
Southern Cattlemen's Association.....	John D. Eldridge.....	Little Rock, Ark.....	R. M. Gow.....	Little Rock, Ark.
National Swine Growers' Association.....	Robt. J. Evans.....	Union Stock Yards, Chicago, Ill.	W. J. Carmichael.....	407 South Dearborn Street, Chi- cago, Ill.
American Poultry Association.....	A. F. Cooper.....	Pittsburgh, Pa.....	Mrs. E. B. Campbell.....	318 Citizen's Trust Building, Fort Wayne, Ind.
National Wool Growers' Association.....	F. J. Hagenbarth.....	Spencer, Idaho.....	S. W. McClure.....	Salt Lake City, Utah.
National Mohair Growers' Association.....	U. S. Grant.....	Dallas, Oreg.....	F. O. Landrum.....	Laguna, Tex.

STATISTICS OF GRAIN CROPS, 1918.

CORN.

TABLE 1.—*Corn: Area and production in undermentioned countries, 1916-1918.*

Country.	Area.			Production.		
	1916	1917	1918	1916	1917	1918
NORTH AMERICA.						
United States.....	<i>Acres.</i> 105,296,000	<i>Acres.</i> 116,730,000	<i>Acres.</i> 107,494,000	<i>Bushels.</i> 2,566,927,000	<i>Bushels.</i> 3,065,233,000	<i>Bushels.</i> 2,582,814,000
Canada:						
British Columbia.....			(1)			11,000
Ontario.....	160,000	160,000	195,000	5,960,000	5,960,000	5,664,000
Quebec.....	13,000	74,000	55,000	322,000	1,803,000	1,272,000
Total.....	173,000	234,000	250,000	6,282,000	7,763,000	6,947,000
Mexico.....				2 110,065,000		
Total.....				2,683,274,000		
SOUTH AMERICA.						
Argentina.....	9,928,000	8,969,000	8,715,000	161,133,000	58,839,000	170,660,000
Chile.....	66,000			1,570,000	1,331,000	
Uruguay.....	697,000			4,604,000		
Total.....	10,691,000			167,307,000		
EUROPE.						
Austria-Hungary:						
Austria ³	4 362,000			4 8,050,000		
Hungary proper.....	4 6,194,000			4 180,550,000		
Croatia-Slavonia.....				4 25,000,000		
Bosnia-Herzegovina.....				4 7,000,000		
Total Austria-Hungary.....				220,600,000		
Bulgaria.....	5 1,571,000			4 35,000,000		
France.....	812,000	738,000	841,000	4 17,104,000	16,215,000	
Italy.....	3,918,000	3,572,000	3,459,000	81,547,000	75,452,000	
Portugal.....				4 9,275,000		
Roumania.....	5,056,000	1,077,000		4 86,412,000		
Russia:						
Russia proper.....	2,865,000			62,207,000		
Northern Caucasia.....	4 917,000			4 18,520,000		
Total Russia.....	3,782,000			80,727,000		
Serbia.....				4 12,000,000		
Spain.....	1,154,000	1,175,000	1,169,000	28,642,000	29,369,000	24,141,000
Switzerland.....	4,000	5,000	7,000	150,000	252,000	358,000
Total.....				571,457,000		
ASIA.						
British India.....	6,679,000	6,241,000		100,080,000	93,760,000	
Japan.....	144,000	142,000	144,000	4,102,000	3,705,000	
Philippine Islands.....	1,069,000	1,058,000		14,083,000	13,441,000	
Total.....	7,892,000	7,441,000		118,265,000	110,906,000	
AFRICA.						
Algeria.....		20,000			302,000	
Egypt.....	1,850,000	1,685,000		68,362,000	63,757,000	
Union of South Africa.....	2,740,000	3,150,000	3,300,000	26,304,000	36,516,000	29,708,000
Total.....	4,590,000	4,855,000		94,366,000	100,575,000	

¹ Less than 500.

² Figures for 1906.

³ Galicia and Bukowina not included.

⁴ Figures for 1915.

⁵ Figures for 1914.

CORN—Continued.

TABLE 1.—Corn: Area and production in undermentioned countries, 1916–1918—Contd.

Country.	Area.			Production.		
	1916	1917	1918	1916	1917	1918
AUSTRALASIA.						
Australia:	<i>Acres.</i>	<i>Acres.</i>	<i>Acres.</i>	<i>Bushels.</i>	<i>Bushels.</i>	<i>Bushels.</i>
Queensland.....	146,000	181,000	2,003,000	3,019,000
New South Wales.....	154,000	155,000	3,773,000	4,333,000
Victoria.....	22,000	23,000	1,000,000	1,172,000
Western Australia.....	(1)	(1)	(1)	1,000
South Australia.....	1,000	(1)	16,000	1,000
Total Australia.....	324,000	360,000	6,794,000	8,527,000
New Zealand.....	8,000	6,000	8,000	340,000	274,000	425,000
Total Australasia...	332,000	366,000	7,134,000	8,801,000
Grand total.....	3,642,103,000

¹ Less than 500.

TABLE 2.—Corn: Total production of countries named in Table 1, 1895–1916.

Year.	Production.	Year.	Production.	Year.	Production.	Year.	Production.
	<i>Bushels.</i>		<i>Bushels.</i>		<i>Bushels.</i>		<i>Bushels.</i>
1895....	2,834,750,000	1901.....	2,366,883,000	1907....	3,420,321,000	1913....	3,587,429,000
1896....	2,964,435,000	1902.....	3,187,311,000	1908....	3,606,931,000	1914....	3,777,913,000
1897....	2,587,206,000	1903.....	3,066,506,000	1909....	3,563,226,000	1915....	4,201,589,000
1898....	2,682,619,000	1904.....	3,109,252,000	1910....	4,031,630,000	1916....	3,642,103,000
1899....	2,724,100,000	1905.....	3,461,181,000	1911....	3,481,007,000		
1900....	2,792,561,000	1906.....	3,963,645,000	1912....	4,371,888,000		

TABLE 3.—Corn: Acreage, production, value, exports, etc., in the United States, 1849–1918.

NOTE.—Figures in *italics* are census returns; figures in *roman* are estimates of the Department of Agriculture. Estimates of acres are obtained by applying estimated percentages of increase or decrease to the published numbers of the preceding year, except that a revised base is used for applying percentage estimates whenever new census data are available.

Year.	Acreage.	Average yield per acre.	Production.	Average farm price per bushel Dec. 1.	Farm value Dec. 1.	Chicago cash price per bushel, contract. ¹				Domestic exports, including corn meal, fiscal year beginning July 1.	Per cent of crop exported.
						December.		Following May.			
						Low.	High.	Low.	High.		
1849.....			<i>592,071,000</i>							<i>7,632,860</i>	1.3
1859.....			<i>838,793,000</i>							<i>4,248,991</i>	.5
1866....	34,307,000	25.3	867,946,000	47.4	411,451,000	53	62	64	79	16,026,947	1.8
1867....	32,520,000	23.6	768,320,000	57.0	437,770,000	61	65	61	71	12,493,522	1.6
1868....	34,887,000	26.0	906,527,000	46.8	424,057,000	38	58	44	51	8,286,665	.9
1869....	37,103,000	23.6	874,320,000	59.8	522,551,000	56	67	73	85	2,140,487	.2
1869....			<i>760,945,000</i>								
1870....	38,647,000	28.3	1,094,255,000	49.4	540,520,000	41	59	46	52	10,673,553	1.0
1871....	34,091,000	29.1	991,898,000	43.4	430,356,000	36	39	38	43	35,727,010	3.6
1872....	35,527,000	30.8	1,092,719,000	35.3	385,736,000	27	28	34	39	40,154,374	3.7
1873....	39,197,000	23.8	932,274,000	44.2	411,961,000	40	49	49	59	35,985,834	3.9
1874....	41,037,000	20.7	850,148,000	58.4	496,271,000	64	76	53	67	30,025,036	3.5

¹ No. 2 to 1908.

CORN—Continued.

TABLE 3.—Corn: Acreage, production, value, exports, etc., in the United States, 1849-1918—Continued.

Year.	Acreage.	Average yield per acre.	Production.	Average farm price per bushel Dec. 1.	Farm value Dec. 1.	Chicago cash price per bushel, contract. ¹				Domestic exports, including corn meal, fiscal year beginning July 1.	Per cent of crop exported.
						December.		Following May.			
						Low.	High.	Low.	High.		
	<i>Acres.</i>	<i>Bush.</i>	<i>Bushels.</i>	<i>Cents.</i>	<i>Dollars.</i>	<i>Cts.</i>	<i>Cts.</i>	<i>Cts.</i>	<i>Cts.</i>	<i>Bushels.</i>	<i>P.ct.</i>
1875...	44,841,000	29.5	1,321,069,000	36.7	484,675,000	40	47	41	45	50,910,532	3.9
1876...	49,033,000	26.2	1,283,828,000	34.0	436,109,000	40	43	43	56	72,652,611	5.7
1877...	50,369,000	26.7	1,342,558,000	34.8	467,635,000	41	49	35	41	87,192,110	6.5
1878...	51,585,000	26.9	1,388,219,000	31.7	440,281,000	30	32	33	36	87,884,892	6.3
1879...	53,085,000	29.2	1,547,902,000	37.5	580,486,000	39	43½	32½	36½	99,572,329	6.4
1879...	62,369,000	28.1	1,754,592,000
1880...	62,318,000	27.6	1,717,435,000	39.6	679,714,000	35½	42	41½	45	93,648,147	5.5
1881...	64,262,000	18.6	1,194,916,000	63.6	759,482,000	58½	63½	69	76½	44,340,683	3.7
1882...	65,660,000	24.6	1,617,025,000	48.5	783,867,000	49½	61	53½	56½	41,655,653	3.6
1883...	68,302,000	22.7	1,551,067,000	42.4	658,051,000	54½	63½	52½	57	46,258,606	2.0
1884...	69,684,000	25.8	1,795,528,000	35.7	640,736,000	34½	40½	44½	49	52,876,456	2.9
1885...	73,130,000	26.5	1,936,176,000	32.8	635,675,000	36	42½	34½	36½	64,829,617	3.3
1886...	75,694,000	22.0	1,665,441,000	36.6	610,311,000	35½	38	36½	39½	41,368,584	2.5
1887...	72,393,000	20.1	1,456,161,000	44.4	646,107,000	47	51½	54	60	25,360,869	1.7
1888...	75,673,000	26.3	1,987,790,000	34.1	677,562,000	33½	35½	33½	37	70,841,673	3.6
1889...	78,320,000	27.0	2,112,892,000	28.3	597,919,000	29½	35	32½	35	103,418,709	4.9
1889...	72,088,000	29.4	2,122,328,000
1890...	71,971,000	27.0	1,489,970,000	50.6	754,433,000	47½	53	55	69½	32,041,529	2.2
1891...	76,205,000	20.7	2,060,154,000	40.6	836,439,000	39½	59	40½	100	76,602,285	3.7
1892...	70,627,000	23.1	1,628,464,000	39.4	642,147,000	40	42½	39½	44½	47,121,894	2.9
1893...	72,036,000	22.5	1,619,496,000	36.5	591,626,000	34½	36½	36½	38½	66,489,529	2.1
1894...	62,582,000	19.4	1,212,770,000	45.7	554,719,000	44½	47½	47½	55½	28,585,405	2.4
1895...	82,076,000	26.2	2,151,139,000	25.3	544,986,000	25	26½	27½	29½	101,100,375	4.7
1896...	81,027,000	28.2	2,283,875,000	21.5	491,007,000	22½	23	23	25½	178,817,417	7.8
1897...	80,095,000	23.8	1,902,968,000	26.3	501,073,000	25	27½	32½	37	212,055,543	11.1
1898...	77,722,000	24.8	1,924,185,000	28.7	552,023,000	33½	38	32½	34	177,255,046	9.2
1899...	82,109,000	25.3	2,078,144,000	30.3	629,210,000	30	31½	36	40½	213,123,412	10.3
1899...	94,914,000	28.1	2,666,324,000
1900...	83,321,000	25.3	2,103,103,000	35.7	751,220,000	35½	40½	42½	58½	181,405,473	8.6
1901...	91,350,000	16.7	1,522,520,000	60.5	921,556,000	62½	67½	59½	64½	28,028,688	1.8
1902...	94,044,000	26.8	2,523,648,000	40.3	1,017,017,000	43½	57½	44	46	76,639,261	3.0
1903...	88,092,000	25.5	2,244,177,000	42.5	952,869,000	41	43½	47½	50	58,222,061	2.6
1904...	92,232,000	26.8	2,467,481,000	44.1	1,087,461,000	43½	49	48	64½	90,293,483	3.7
1905...	94,011,000	28.8	2,707,994,000	41.2	1,116,697,000	42	50½	47½	50	119,893,833	4.4
1906...	96,738,000	30.3	2,927,416,000	39.9	1,166,626,000	40	46	49½	56	86,368,228	3.0
1907...	99,931,000	25.9	2,592,320,000	51.6	1,336,901,000	57½	61½	67½	82	55,063,860	2.1
1908...	101,788,000	26.2	2,668,651,000	60.6	1,616,145,000	56½	62½	72½	76	37,665,040	1.4
1909...	108,771,000	25.5	2,772,376,000
1909...	98,383,000	25.9	2,552,190,000	57.9	1,477,222,000	62½	66	56	63	38,128,498	1.5
1910 ³ ...	104,035,000	27.9	2,886,260,000	48.0	1,384,817,000	45½	50	52½	55½	65,614,522	2.3
1911...	105,825,000	23.7	2,531,488,000	61.8	1,565,258,000	68	70	76½	82½	41,797,291	1.7
1912...	107,083,000	29.2	3,124,746,000	48.7	1,520,454,000	47½	54	55½	60	50,780,143	1.6
1913...	105,820,000	23.1	2,446,988,000	69.1	1,692,092,000	64	73½	67	72½	10,725,819	.4
1914...	103,435,000	25.8	2,672,804,000	64.4	1,722,070,000	62½	68½	50½	56	50,668,303	1.9
1915...	106,197,000	28.2	2,994,793,000	57.5	1,722,680,000	69½	75	69	78½	39,896,928	1.3
1916...	105,296,000	24.4	2,566,927,000	88.9	2,280,729,000	88	96	152	174	66,753,294	2.6
1917...	116,730,000	26.3	3,065,233,000	127.9	3,920,228,000	160	190	150	170	49,073,263	1.6
1918...	107,494,000	24.0	2,582,814,000	136.6	3,528,313,000	135	155

¹ No. 2 to 1908.

² Coincident with "corner."

³ Figures adjusted to census basis.

CORN—Continued.

TABLE 4.—*Corn: Revised acreage, production, and farm value, 1879, and 1889–1909.*

[NOTE.—This revision for 1879 and 1889–1909 consists (1) in using the Department of Agriculture's estimates of average yield per acre to compute, from census acreage, the total production, (2) in adjusting the department's estimates of acreage for each year so as to be consistent with the following as well as the preceding census acreage, and (3) in recomputing total farm value from these revised production figures.]

Year.	Acreage.	Average yield per acre.	Production.	Average farm price per bushel Dec. 1.	Farm value Dec. 1.
	<i>Acres.</i>	<i>Bushels.</i>	<i>Bushels.</i>	<i>Cents.</i>	<i>Dollars.</i>
1879.....	62,369,000	29.2	1,823,163,000	37.1	676,251,000
1889.....	72,088,000	27.7	1,998,648,000	27.4	546,984,000
1890.....	70,390,000	20.7	1,460,406,000	50.0	729,647,000
1891.....	74,496,000	27.6	2,055,823,000	39.7	816,917,000
1892.....	72,610,000	23.6	1,713,688,000	38.8	664,390,000
1893.....	74,434,000	22.9	1,707,572,000	35.9	612,998,000
1894.....	69,396,000	19.3	1,339,680,000	45.1	604,523,000
1895.....	85,567,000	27.0	2,310,952,000	25.0	578,408,000
1896.....	86,560,000	28.9	2,503,484,000	21.3	532,884,000
1897.....	88,127,000	24.3	2,144,553,000	26.0	558,309,000
1898.....	88,304,000	25.6	2,261,119,000	28.4	642,747,000
1899.....	94,914,000	25.9	2,454,626,000	29.9	734,917,000
1900.....	95,042,000	26.4	2,505,148,000	35.1	878,243,000
1901.....	94,636,000	17.0	1,697,288,000	60.0	964,543,000
1902.....	95,517,000	27.4	2,620,699,000	40.0	1,048,735,000
1903.....	90,661,000	25.8	2,339,417,000	42.1	984,173,000
1904.....	93,340,000	27.0	2,520,682,000	43.7	1,101,430,000
1905.....	93,573,000	29.3	2,744,329,000	40.7	1,116,817,000
1906.....	93,643,000	30.9	2,895,822,000	39.2	1,135,969,000
1907.....	94,971,000	26.5	2,512,065,000	50.9	1,277,607,000
1908.....	95,603,000	26.6	2,544,957,000	60.0	1,527,679,000
1909.....	98,383,000	26.1	2,572,336,000	58.6	1,507,185,000

TABLE 5.—*Corn: Acreage, production, and total farm value, by States, 1917 and 1918.*

State.	Thousands of acres.		Production (thousands of bushels).		Total value, basis December 1 price (thousands of dollars).	
	1918	1917	1918	1917	1918	1917
Maine.....	27	19	1,215	703	2,029	1,603
New Hampshire.....	28	24	1,260	960	1,890	2,083
Vermont.....	45	39	1,710	1,755	2,907	3,738
Massachusetts.....	40	32	2,080	1,440	3,536	3,096
Rhode Island.....	13	13	572	546	1,030	1,289
Connecticut.....	56	48	2,800	2,400	4,788	5,160
New York.....	820	820	29,520	25,420	51,660	50,332
New Jersey.....	279	297	11,439	12,474	17,158	21,206
Pennsylvania.....	1,560	1,575	62,400	61,425	96,720	93,980
Delaware.....	235	230	7,285	7,820	9,908	10,948
Maryland.....	686	700	24,010	27,300	32,414	38,220
Virginia.....	2,000	2,100	56,000	56,700	89,600	86,751
West Virginia.....	800	800	24,800	24,000	44,640	40,800
North Carolina.....	3,005	2,920	64,365	58,400	113,926	99,280
South Carolina.....	2,250	2,150	38,250	40,850	74,588	78,432
Georgia.....	4,590	4,500	68,850	72,000	113,602	115,200
Florida.....	880	800	16,080	12,000	19,430	16,800
Ohio.....	3,700	3,950	133,200	150,100	173,160	204,136
Indiana.....	5,138	5,466	169,554	196,776	201,769	245,970
Illinois.....	9,900	11,000	351,450	418,000	421,740	450,800
Michigan.....	1,610	1,750	48,300	37,625	62,790	68,478
Wisconsin.....	1,717	1,918	69,538	42,196	90,899	63,779
Minnesota.....	2,750	3,060	110,000	91,800	122,100	100,980
Iowa.....	10,434	11,100	375,624	410,700	458,261	443,556
Missouri.....	6,693	6,900	133,860	241,500	191,420	275,310

CORN—Continued.

TABLE 5.—Corn: Acreage, production, and total farm value, by States, 1917 and 1918—Continued.

State.	Thousands of acres.		Production (thousands of bushels).		Total value, basis December 1 price (thousands of dollars).	
	1918	1917	1918	1917	1918	1917
North Dakota.....	484	590	9,106	5,310	11,955	8,018
South Dakota.....	3,182	3,350	108,188	93,800	119,007	112,560
Nebraska.....	6,954	9,240	123,086	249,480	157,550	299,376
Kansas.....	6,130	9,156	48,523	119,028	64,849	148,785
Kentucky.....	3,600	3,650	93,600	114,975	136,656	139,120
Tennessee.....	3,500	3,600	84,000	104,400	121,800	125,280
Alabama.....	4,636	4,825	67,686	77,200	100,175	96,500
Mississippi.....	3,900	3,786	66,300	77,613	100,113	107,106
Louisiana.....	1,850	1,800	29,600	32,400	47,656	47,304
Texas.....	6,900	6,900	69,000	75,900	121,440	126,753
Oklahoma.....	3,250	3,900	24,375	33,150	39,975	48,730
Arkansas.....	2,700	2,674	35,100	64,176	63,180	89,846
Montana.....	100	81	2,100	1,012	2,835	1,771
Wyoming.....	40	35	1,000	700	1,400	1,225
Colorado.....	527	532	11,067	10,640	14,940	13,300
New Mexico.....	170	170	4,250	3,400	7,650	6,392
Arizona.....	34	32	952	864	1,999	1,642
Utah.....	24	26	672	500	1,216	850
Nevada.....	2	2	64	60	134	90
Idaho.....	23	18	920	558	1,684	865
Washington.....	43	41	1,634	1,517	2,778	2,458
Oregon.....	44	42	1,364	1,260	2,114	1,890
California.....	85	75	2,975	2,400	5,742	4,440
United States.....	107,494	116,730	2,582,814	3,065,233	3,528,313	3,920,228

TABLE 6.—Corn: Production and distribution in the United States, 1897–1918.

[000 omitted.]

Year.	Old stock on farms Nov. 1.	Crop.			Total supplies.	Stock on farms Mar. 1 following.	Shipped out of county where grown.
		Quantity.	Quality.	Proportion merch- antable.			
	<i>Bushels.</i>	<i>Bushels.</i>	<i>Per cent.</i>	<i>Per cent.</i>	<i>Bushels.</i>	<i>Bushels.</i>	<i>Bushels.</i>
1897.....	290,934	1,902,968	86.3	84.8	2,193,902	782,871	411,617
1898.....	137,894	1,924,185	83.8	86.8	2,062,079	800,533	396,005
1899.....	113,644	2,078,144	87.2	82.2	2,191,788	773,730	348,098
1900.....	92,328	2,105,103	85.5	86.9	2,197,431	776,166	478,417
1901.....	96,825	1,522,520	73.7	86.3	1,618,345	441,132	153,213
1902.....	29,267	2,523,648	83.1	2,552,915	1,050,653	557,296
1903.....	131,210	2,244,177	86.2	78.2	2,375,387	839,053	419,877
1904.....	80,246	2,467,481	90.6	76.0	2,547,727	954,268	551,635
1905.....	82,285	2,707,994	90.6	84.8	2,790,279	1,108,364	681,539
1906.....	119,633	2,927,416	89.9	88.4	3,047,049	1,297,979	679,544
1907.....	130,995	2,592,320	82.8	89.1	2,723,315	962,429	467,675
1908.....	71,124	2,668,651	86.9	77.7	2,739,775	1,047,763	568,129
1909.....	79,779	2,552,190	84.2	88.2	2,631,969	977,561	635,248
1910.....	115,696	2,886,260	87.2	82.5	3,001,956	1,165,378	661,777
1911.....	123,824	2,531,488	80.6	86.4	2,655,312	884,059	517,766
1912.....	64,764	3,124,746	85.5	80.1	3,189,510	1,290,642	680,831
1913.....	137,972	2,446,988	82.2	85.0	2,584,960	866,352	422,059
1914.....	80,046	2,672,804	85.1	80.1	2,752,850	910,894	498,285
1915.....	96,009	2,994,793	77.2	84.5	3,090,892	1,116,559	560,824
1916.....	87,908	2,566,927	83.8	71.1	2,654,835	782,303	450,589
1917.....	34,448	3,065,233	75.2	83.9	3,099,681	1,253,290	678,027
1918.....	114,678	2,582,814	85.6	60.0	2,697,492	884,476	374,604

CORN—Continued.

TABLE 7.—Corn: Yield per acre, price per bushel Dec. 1, and value per acre, by States.

State.	Yield per acre (bushels).										Farm price per bushel (cents).					Value per acre (dollars). ¹			
	10-year average, 1909-1918.	1909	1910	1911	1912	1913	1914	1915	1916	1917	1918	10-year average, 1909-1918.	1914	1915	1916	1917	1918	5-year average, 1914-1918.	1918
Me.	41.8	38.0	46.0	44.0	40.0	38.0	46.0	41.0	43.0	37.0	45.0	109	88	85	119	228	167	57.20	75.15
N. H.	43.1	35.1	46.0	45.0	46.0	37.0	46.0	45.0	46.0	40.0	45.0	102	82	76	115	217	150	55.82	67.50
Vt.	41.7	37.0	43.0	41.0	40.0	37.0	47.0	46.0	43.0	45.0	38.0	103	81	84	110	213	170	56.89	64.60
Mass.	44.6	38.0	45.5	44.0	45.0	40.5	47.0	47.0	42.0	45.0	52.0	107	85	80	120	215	170	62.62	88.40
R. I.	39.8	33.2	40.0	45.0	41.5	36.5	42.0	43.0	31.0	42.0	44.0	121	98	100	138	236	180	61.05	79.20
Conn.	47.0	41.0	53.2	48.5	50.0	38.5	46.0	50.0	43.0	50.0	50.0	107	89	85	120	215	171	65.61	85.50
N. Y.	35.8	36.0	38.3	38.5	38.6	28.5	41.0	40.0	30.0	31.0	36.0	101	83	78	110	198	175	44.52	63.00
N. J.	38.2	32.7	36.0	36.3	38.0	39.5	38.5	38.0	40.0	42.0	41.0	92	76	75	100	170	150	46.13	61.50
Pa.	39.8	32.0	41.0	44.5	42.5	39.0	42.5	38.5	39.0	39.0	40.0	88	73	70	97	153	155	43.49	62.00
Del.	32.9	31.0	31.8	34.0	34.0	31.5	36.0	31.5	34.0	34.0	31.0	77	62	62	89	140	136	32.37	42.16
Md.	35.6	31.4	33.5	36.5	36.5	33.0	37.0	35.0	39.0	39.0	35.0	80	68	61	89	140	135	36.61	47.25
Va.	25.5	23.2	25.5	24.0	24.0	26.0	20.5	28.5	28.0	27.0	28.0	92	81	71	93	153	160	30.56	44.80
W. Va.	30.2	31.4	26.0	25.7	33.8	31.0	31.0	31.5	30.5	33.0	31.0	97	83	74	101	170	180	37.33	55.80
N. C.	19.2	16.8	18.6	18.4	18.2	19.2	20.3	21.0	18.5	20.0	21.0	103	86	77	110	170	177	25.03	37.17
S. C.	17.7	16.7	18.5	18.2	17.9	19.5	18.5	16.5	15.5	19.0	17.0	112	92	87	113	192	195	23.71	33.15
Ga.	14.9	13.9	14.5	16.0	13.8	15.5	14.0	15.0	15.5	16.0	15.0	101	85	78	100	160	165	17.89	24.75
Fla.	14.5	12.6	13.0	14.6	13.0	15.0	16.0	15.0	15.0	15.0	16.0	93	80	73	90	140	138	16.07	22.08
Ohio.	38.1	39.5	36.5	38.6	42.8	37.5	39.1	41.5	31.5	38.0	36.0	74	61	56	90	136	130	34.78	46.80
Ind.	36.6	40.0	39.3	36.0	40.3	36.0	33.0	38.0	34.0	36.0	33.0	68	58	51	84	125	119	30.27	39.27
Ill.	34.3	35.9	39.1	33.0	40.0	27.0	29.0	36.0	29.5	38.0	35.5	68	61	54	84	110	120	29.26	42.60
Mich.	31.5	35.4	32.4	33.0	34.0	33.5	36.0	32.0	27.5	21.5	30.0	84	67	68	95	182	130	30.03	39.00
Wis.	34.0	33.0	32.5	36.3	35.7	40.5	40.5	23.0	36.0	22.0	40.5	80	65	68	92	163	130	32.72	52.65
Minn.	33.7	34.8	32.7	33.7	34.5	40.0	35.0	23.0	33.5	30.0	40.0	65	52	62	80	110	111	27.33	44.40
Iowa.	35.3	31.5	36.3	31.0	43.0	34.0	38.0	30.0	36.5	37.0	36.0	65	55	51	80	108	122	29.86	43.92
Mo.	26.1	26.4	33.0	26.0	32.0	17.5	22.0	29.5	19.5	35.0	20.0	76	68	57	90	114	143	23.57	28.60
N. Dak.	22.2	31.0	14.0	25.0	26.7	28.8	28.0	14.0	26.5	9.0	19.0	76	58	67	84	151	130	17.23	24.70
S. Dak.	28.0	31.7	25.0	22.0	30.6	25.5	26.0	29.0	28.5	28.0	34.0	64	50	49	77	120	110	24.03	37.40
Nebr.	23.6	24.8	25.8	21.0	24.0	15.0	24.5	30.0	26.0	27.0	17.7	67	53	47	78	120	128	20.48	22.66
Kans.	15.9	19.9	19.0	14.5	23.0	3.2	18.5	31.0	10.0	13.0	7.1	76	63	51	90	125	149	12.66	10.58
Ky.	27.5	29.0	29.0	26.0	30.4	20.5	25.0	30.0	28.0	31.5	26.0	78	64	56	87	121	146	26.65	37.96
Tenn.	25.2	22.0	25.9	26.8	26.5	20.5	24.0	27.0	26.0	29.0	24.0	81	68	58	94	120	145	25.20	34.80
Ala.	16.1	13.5	18.0	18.0	17.2	17.3	17.0	17.0	12.5	16.0	14.6	93	80	69	102	125	148	15.94	21.61
Miss.	18.1	14.5	20.5	19.0	18.3	20.0	18.5	19.0	14.0	20.5	17.0	89	73	65	98	138	151	18.71	25.67
La.	20.0	23.0	23.6	18.5	18.0	22.0	19.3	20.5	21.0	18.0	16.0	88	75	64	94	146	161	19.88	25.76
Tex.	17.3	15.0	20.0	9.5	21.0	24.0	19.5	23.5	19.0	11.0	10.0	94	74	58	104	167	176	16.76	17.60
Okla.	14.1	17.0	16.0	6.5	18.7	11.0	12.5	29.5	13.5	8.5	7.5	80	64	46	93	147	164	11.79	12.30
Ark.	19.7	18.0	24.0	20.8	20.4	19.0	17.5	23.0	17.7	24.0	13.0	91	80	64	98	140	180	20.61	23.40
Mont.	25.6	35.0	23.0	26.5	25.5	31.5	28.0	28.0	25.0	25.0	21.0	96	76	69	93	175	135	22.82	28.35
Wyo.	22.2	28.0	10.0	15.0	23.0	29.0	25.0	25.0	22.0	20.0	25.0	91	70	67	90	175	140	24.81	35.00
Colo.	19.7	24.2	19.9	14.0	20.8	15.0	23.0	24.0	15.5	20.0	21.0	80	60	55	90	125	135	18.86	28.35
N. Mex.	24.0	31.3	23.0	24.7	22.4	18.5	28.0	26.0	21.0	20.0	25.0	105	80	73	113	188	180	29.54	45.00
Ariz.	31.1	32.1	32.5	33.0	33.0	28.0	32.0	30.0	35.0	27.0	28.0	129	120	115	140	190	210	46.40	58.80
Utah.	31.6	31.4	30.3	35.0	30.0	34.0	35.0	34.0	33.0	25.0	28.0	102	75	80	115	170	181	36.92	50.68
Nev.	32.4	—	—	—	—	—	—	—	—	—	—	118	110	93	125	150	210	45.37	67.20
Idaho.	32.9	30.6	32.0	30.0	32.8	32.0	31.0	35.0	35.0	31.0	40.0	94	72	65	100	155	183	40.26	73.20
Wash.	30.6	27.8	28.0	28.5	27.3	28.0	27.0	27.0	37.0	37.0	38.0	98	73	77	100	162	170	40.41	64.60
Oreg.	30.4	30.7	25.5	28.5	31.5	28.0	30.0	35.0	33.0	30.0	31.0	95	82	82	95	150	155	35.03	48.05
Calif.	35.4	34.8	37.5	36.0	37.0	33.0	36.0	41.0	32.0	32.0	35.0	111	87	88	124	185	193	46.77	67.55
U. S.	25.8	25.5	27.7	23.9	29.2	23.1	25.8	28.2	24.4	26.3	24.0	76.2	64.4	57.5	88.9	127.9	136.6	24.19	32.82

¹ Based upon farm price Dec. 1.

CORN—Continued.

TABLE 8.—Corn: Wholesale price per bushel, 1913–1918.

Date.	New York.			Baltimore.			Cincinnati.			Chicago.			Detroit.			St. Louis.			San Francisco.		
	No. 2 yellow.			Mixed.			No. 2 mixed.			Contract.			No. 3.			No. 2.			White (per 100 pounds).		
	Low.	High.	Average.	Low.	High.	Average.	Low.	High.	Average.	Low.	High.	Average.	Low.	High.	Average.	Low.	High.	Average.	Low.	High.	Average.
1913.	<i>Cts.</i>	<i>Cts.</i>	<i>Cts.</i>	<i>Cts.</i>	<i>Cts.</i>	<i>Cts.</i>	<i>Cts.</i>	<i>Cts.</i>	<i>Cts.</i>	<i>Cts.</i>	<i>Cts.</i>	<i>Cts.</i>	<i>Cts.</i>	<i>Cts.</i>	<i>Cts.</i>	<i>Cts.</i>	<i>Cts.</i>	<i>Cts.</i>	<i>Dolls.</i>	<i>Dolls.</i>	<i>Dolls.</i>
Jan.–June.....	55½	66	58.8	52½	65½	57.3	48	65	56.5	46½	63	54.0	48	62	54.0	45	64	54.0	1.59	1.80	1.701
July–Dec.....	79	86	82.9	64½	68	66.0	63½	85	73.2	60	78½	71.0	60½	78	71.0	61½	82	72.6	1.51½	1.87	1.743
1914.																					
Jan.–June.....	60	82½	75.4	66½	77	70.6	64	75	72.9	60	73½	66.4	62	74	67.1	63	73½	68.6	1.61	1.78	1.708
July–Dec.....	71½	93½	82.1	67½	89	79.4	63½	88½	78.3	62½	86	73.4	63½	88	75.0	62½	87	73.6	1.67½	1.93	1.820
1915.																					
Jan.–June.....	77½	90½	84.6	72	84½	78.7	70	81	76.5	68½	79	74.3	70	80	75.6	68½	78½	74.3	1.72	1.90	1.82
July–Dec.....	72½	92½	82.8	67½	87	77.2	62	84	72.8	59½	82½	72.0	64	84	74.9	58½	81	70.4	1.46	1.80	1.685
1916.																					
Jan.–June.....	79½	92½	86.2	70	84½	79.6	70½	79	75.7	69	79½	75.2	71½	79½	75.8	69½	77	73.9	1.70	1.80	1.732
July–Dec.....	88½	120	101.6	85½	107	96.1	79	107	90.0	78	111	90.4	79½	117	94.0	75½	111	89.4	1.75	2.45	1.881
1917.																					
January.....	93½	116½	111.2	105	115½	111.1	95	105½	101.8	93½	103	99.0	102	106	104.0	94½	102	98.8	2.05	2.20	2.113
February.....	108½	121½	115.8	106	116½	112.8	103	109	105.7	96½	102½	100.8	102	107	105.0	95½	101	99.5	2.15	2.22	2.198
March.....	118	132½	125.4	114	128	119.1	105½	122	112.5	102½	122½	111.8	107	127	115.7	101½	123	112.1	2.20	2.60	2.347
April.....	134	173½	156.7	128½	173½	149.0	128½	154½	144.3	123	160	145.1	133½	165	150.5	126	161	146.6	2.55	3.30	3.006
May.....	162½	183	175.7	164	180	172.8	154	173	163.7	152	174	164.0	161	175	168.8	152½	171	163.2	3.25	3.50	3.365
June.....	170½	186	180.1	161	182	177.0	164½	176	172.8	158	176	170.8	162	176½	171.9	155	175½	169.4	3.20	3.40	3.340
Jan.–June.....	93½	186	144.2	105	182	140.3	95	176	133.5	93½	176	131.9	102	176½	136.0	94½	175½	131.6	2.05	3.50	2.728
July.....	189	239½	214.6	183½	221	200.0	182	223	197.6	177½	232	204.1	181	235	206.7	177	231	202.9	3.35	4.50	3.762
August.....	181	245	212.1	178	230	197.7	170	235	202.5	169	236	196.5	182	240	206.9	161	233	195.0	3.65	4.67	4.225
September.....	205	235	222.7	190	215½	205.2	197	214	205.0	195	224	208.6	205	230	217.2	190	222	207.1	3.65	3.70	3.680
October.....	202	220	207.9	198	205	202.8	194	204	195.6	189	215½	197.9	198	220	205.8	190	210	196.4
November.....	154	232	195.4	140	175	162.1	190	224	213.3	185	229	210.0	211	231	224.7	174	196	187.0
December.....	214	214	214.0	155	175	171.1	160	185	173.8	160	190	160.4	200	211	206.3	162½	179	165.6	3.38	3.38	3.380
July–Dec.....	154	245	211.1	140	230	189.8	160	235	198.0	160	236	196.2	181	240	211.3	161	233	192.3	3.35	4.67	3.762

Statistics of Corn.

CORN—Continued.

TABLE 8.—Corn: Wholesale price per bushel, 1913-1918—Continued.

Date.	New York.			Baltimore.			Cincinnati.			Chicago.			Detroit.			St. Louis.			San Francisco.			
	No. 2 yellow.			No. 3 yellow.			No. 2 mixed.			Contract.			No. 3.			No. 2.			White (per 100 pounds).			
	Low.	High.	Average.	Low.	High.	Average.	Low.	High.	Average.	Low.	High.	Average.	Low.	High.	Average.	Low.	High.	Average.	Low.	High.	Average.	
1918.	<i>Cts.</i>	<i>Cts.</i>	<i>Cts.</i>	<i>Cts.</i>	<i>Cts.</i>	<i>Cts.</i>	<i>Cts.</i>	<i>Cts.</i>	<i>Cts.</i>	<i>Cts.</i>	<i>Cts.</i>	<i>Cts.</i>	<i>Cts.</i>	<i>Cts.</i>	<i>Cts.</i>	<i>Cts.</i>	<i>Cts.</i>	<i>Cts.</i>	<i>Cts.</i>	<i>Dolls.</i>	<i>Dolls.</i>	<i>Dolls.</i>
January.....	177	192	182.6	185	192	189.9	170	185	177.9	185	215	189.0	165	179	170.5	3.20	3.40	3.316	3.20	3.40	3.316	
February.....	177½	216½	190.7	185	192	189.9	170	180	174.5	185	195	188.0	170	183	175.1	3.30	3.50	3.441	3.30	3.50	3.441	
March.....	173½	221½	202.4	190	195	194.7	165	175	172.3	175	187	181.0	155	190	172.3	3.40	3.50	3.450	3.40	3.50	3.450	
April.....	160	202½	179.1	170	180	177.3	160	175	166.5	165	180	173.0	160	174	168.3	
May.....	150	181½	162.6	142½	178	170.9	140	145	142.5	150	170	162.3	155	160	155.7	153	172	164.7	
June.....	163½	183½	170.2	141	170	161.7	145	175	161.9	150	165	158.8	150	170	156.8	148	167	156.5	
Jan.-June.....	150	221½	181.3	141	195	178.9	140	175	152.2	150	185	168.7	150	215	173.9	148	190	167.9	3.20	3.50	3.402	
July.....	178½	203½	191.9	168	195	182.3	155	180	166.2	155	175	166.2	170	185	177.8	154	180	167.8	
August.....	187½	209½	200.8	170	185	174.6	164	185	172.5	160	180	169.8	163	187	179.6	162	195	179.8	
September.....	173½	188½	181.7	175	175	175.0	155	170	161.2	140	165	159.4	145	170	159.9	163	170	166.8	
October.....	154	174½	162.7	165	175	169.9	135	165	145.5	135	145	139.4	135	150	141.4	145	150	147.9	
November.....	140	168½	154.6	150	165	157.9	130	145	138.8	130	145	136.5	140	150	144.1	142	147	144.3	
December.....	159½	181½	166.5	150	165	160.8	145	153	149.8	135	155	145.6	145	158	154.3	145	156	149.4	2.75	3.00	2.875	
July-Dec.....	140	209½	176.4	150	195	170.1	130	185	155.7	130	180	152.8	135	187	159.5	142	195	159.3	2.75	3.00	2.875	

CORN—Continued.

TABLE 9.—Corn: Condition of crop, United States, on first of months named, 1898–1918.

Year.	July.	Aug.	Sept.	Oct.	Year.	July.	Aug.	Sept.	Oct.	Year.	July.	Aug.	Sept.	Oct.
1898....	P. ct.	P. ct.	P. ct.	P. ct.	1905....	P. ct.	P. ct.	P. ct.	P. ct.	1912....	P. ct.	P. ct.	P. ct.	P. ct.
1899....	90.5	87.0	84.1	82.0	1906....	87.3	89.0	89.5	89.2	1913....	81.5	80.0	82.1	82.2
1900....	86.5	89.9	85.2	82.7	1907....	87.5	88.0	90.2	90.1	1914....	86.9	75.8	65.1	65.3
1901....	89.5	87.5	80.6	78.2	1908....	82.0	82.8	80.2	78.0	1915....	85.8	74.8	71.7	72.9
1902....	81.3	54.0	51.7	52.1	1909....	82.8	82.5	79.4	77.8	1916....	81.2	79.5	78.8	79.7
1903....	87.5	86.5	84.3	79.6	1910....	89.3	84.4	74.6	73.8	1917....	82.0	75.3	71.3	71.5
1904....	79.4	78.7	80.1	80.8	1911....	85.4	79.3	78.2	80.3	1918....	81.1	78.8	76.7	75.9
	86.4	87.3	84.6	83.9		80.1	69.6	70.3	70.4		87.1	78.5	67.4	68.6

TABLE 10.—Corn: Farm price, cents per bushel on first of each month, 1909–1918.

Date.	1918	1917	1916	1915	1914	1913	1912	1911	1910	1909	Average.
Jan 1.....	134.8	90.0	62.1	66.2	69.6	48.9	62.2	48.2	62.3	60.7	70.5
Feb. 1.....	138.8	95.8	66.7	72.8	68.3	50.6	64.6	49.0	65.2	61.4	73.3
Mar. 1.....	154.3	100.9	68.2	75.1	69.1	52.2	66.6	48.9	65.9	64.7	76.6
Apr. 1.....	153.6	113.4	70.3	75.1	70.7	53.7	71.1	49.7	65.5	67.5	79.1
May 1.....	155.7	150.6	72.3	77.7	72.1	56.8	79.4	51.8	63.5	71.9	85.2
June 1.....	152.5	160.1	74.1	77.9	75.0	60.6	82.5	55.1	65.2	76.3	87.9
July 1.....	153.7	164.6	75.4	77.7	75.5	63.2	81.1	60.0	66.2	77.0	89.4
Aug. 1.....	159.7	196.6	79.4	78.9	76.8	65.4	79.3	65.8	67.2	75.2	94.4
Sept. 1.....	165.7	175.5	83.6	77.3	81.5	75.4	77.6	65.9	66.3	71.0	94.0
Oct. 1.....	159.5	175.1	82.3	70.5	78.2	75.3	70.2	65.7	61.1	67.1	90.5
Nov. 1.....	140.3	146.0	85.0	61.9	70.6	70.7	58.4	64.7	52.6	62.2	81.2
Dec. 1.....	136.6	127.9	88.9	57.5	64.4	69.1	48.7	61.8	48.0	57.9	76.1
Average.....	147.3	129.2	73.8	71.2	71.4	59.4	67.6	55.3	62.1	65.9	80.3

TABLE 11.—Corn (including meal): International trade, calendar years 1909–13, 1916, 1917.

[The item *maicens* or *maizena* is included as "Corn and cornmeal."]

GENERAL NOTE.—Substantially the international trade of the world. It should not be expected that the world export and import totals for any year will agree. Among sources of disagreement are these: (1) Different periods of time covered in the "year" of the various countries; (2) imports received in year subsequent to year of export; (3) want of uniformity in classification of goods among countries; (4) different practices and varying degrees of failure in recording countries of origin and ultimate destination; (5) different practices of recording reexported goods; (6) opposite methods of treating free ports; (7) clerical errors, which, it may be assumed, are not infrequent.

The exports given are domestic exports, and the imports given are imports for consumption as far as it is feasible and consistent so to express the facts. While there are some inevitable omissions, on the other hand, there are some duplications because of reshipments that do not appear as such in official reports. For the United Kingdom, import figures refer to imports for consumption, when available otherwise total imports, less exports, of "foreign and colonial merchandise." Figures for the United States include Alaska, Porto Rico, and Hawaii.

EXPORTS.

[000 omitted.]

Country.	Average, 1909–1913.	1916 (prelim.)	1917 (prelim.)	Country.	Average, 1909–1913.	1916 (prelim.)	1917 (prelim.)
FROM—	<i>Bushels.</i>	<i>Bushels.</i>	<i>Bushels.</i>	FROM—	<i>Bushels.</i>	<i>Bushels.</i>	<i>Bushels.</i>
Argentina.....	115,749	113,143	Russia.....	30,034	97
Austria-Hungary.....	268	United States.....	45,054	55,237	57,014
Belgium.....	8,130	Uruguay.....	201
British South Africa.....	4,075	6,629	Other countries.....	10,452
Bulgaria.....	9,307	Total.....	270,986
Netherlands.....	8,750				
Roumania.....	38,966				

IMPORTS.

INTO—	1916 (prelim.)	1917 (prelim.)	INTO—	1916 (prelim.)	1917 (prelim.)
Austria-Hungary.....	13,877	Netherlands.....	29,580	27,514
Belgium.....	25,801	Norway.....	1,079	1,889
British South Africa.....	237	48	Portugal.....	1,674
Canada.....	10,629	8,872	Russia.....	335	322
Cuba.....	2,746	Spain.....	9,775	4,248
Denmark.....	11,440	17,721	Sweden.....	1,476
Egypt.....	471	Switzerland.....	3,987	4,767
France.....	18,708	28,379	United Kingdom.....	82,976	68,759
Germany.....	32,160	Other countries.....	4,721
Italy.....	14,895	2,184	Total.....	270,971
Mexico.....	4,404	8,372			

WHEAT.

TABLE 12.—Wheat: Area and production of undermentioned countries, 1916–1918.

Country.	Area.			Production.		
	1916	1917	1918	1916	1917	1918
NORTH AMERICA.						
United States.....	<i>Acres.</i> 52,316,000	<i>Acres.</i> 45,083,000	<i>Acres.</i> 59,110,000	<i>Bushels.</i> 636,318,000	<i>Bushels.</i> 636,655,000	<i>Bushels.</i> 917,100,000
Canada:						
New Brunswick.....	14,000	16,000	49,000	242,000	192,000
Ontario.....	865,000	770,000	714,000	17,931,000	16,318,000
Manitoba.....	2,726,000	2,449,000	2,984,000	29,667,000	41,040,000
Saskatchewan.....	9,032,000	8,273,000	9,249,000	147,559,000	117,921,000
Alberta.....	2,605,000	2,897,000	3,892,000	65,088,000	52,992,000
Other.....	128,000	351,000	465,000	2,294,000	5,280,000
Total Canada.....	15,379,000	14,756,000	17,353,000	262,781,000	233,743,000	189,391,000
Mexico.....	(¹)	(¹)	² 11,468,000
Total.....	910,567,000
SOUTH AMERICA.						
Argentina.....	16,420,000	16,089,000	17,875,000	172,620,000	70,224,000	219,431,000
Chile.....	1,143,000	20,184,000	24,067,000	28,292,000
Uruguay.....	950,000	780,000	1,014,000	9,867,000	5,390,000	12,860,000
Total.....	18,513,000	202,671,000	99,681,000
EUROPE.						
Austria-Hungary:						
Austria ³	⁴ 1,588,000	⁴ 28,286,000
Hungary proper.....	⁴ 8,288,000	⁴ 152,934,000
Croatia-Slavonia.....	⁵ 741,000	⁴ 15,000,000
Bosnia-Herzegovina.....	⁶ 320,000	⁴ 3,000,000
Total Austria-Hungary.....	10,937,000	⁴ 199,220,000
Belgium.....	⁵ 400,000	⁴ 8,000,000
Bulgaria.....	⁵ 2,638,000	38,241,000
Denmark.....	152,000	131,000	141,000	6,044,000	4,296,000	6,320,000
Finland.....	⁷ 8,000	⁶ 196,000
France ⁸	12,429,000	10,439,000	11,927,000	204,908,000	144,149,000
Germany.....	⁴ 4,950,000	⁴ 141,676,000
Greece.....	(¹)	⁴ 6,000,000
Italy.....	11,679,000	10,556,000	10,798,000	176,530,000	139,999,000	176,368,000
Luxemburg.....	27,000	22,000	24,000	433,000	388,000	512,000
Netherlands.....	136,000	122,000	143,000	4,085,000	3,452,000	4,823,000
Norway.....	14,000	20,000	20,000	317,000	432,000
Portugal.....	(¹)	685,000	6,640,000	5,560,000
Roumania.....	4,844,000	78,520,000
Russia:						
Russia proper.....	42,030,000	440,082,000
Poland.....	⁶ 1,312,000	⁶ 24,011,000
Northern Caucasia.....	⁴ 10,021,000	⁴ 127,631,000
Total Russia, European.....	53,363,000	591,724,000
Serbia.....	⁶ 573,000	⁴ 10,000,000	135,709,000
Spain.....	10,148,000	10,340,000	10,228,000	152,329,000	142,674,000	135,709,000
Sweden.....	307,000	329,000	377,000	8,979,000	6,864,000	6,616,000
Switzerland.....	124,000	139,000	203,000	4,053,000	4,556,000	7,095,000
Turkey, European.....	⁹ 19,460,000
United Kingdom:						
England.....	1,862,000	1,855,000	54,941,000	57,397,000
Wales.....	50,000	64,000	1,466,000	1,726,000
Scotland.....	63,000	61,000	2,336,000	2,510,000
Ireland.....	76,000	124,000	2,916,000	4,717,000
Total United Kingdom.....	2,051,000	2,104,000	61,659,000	66,350,000	93,099,000
Total.....	1,699,504,000

¹ No official estimates.² Figures for 1907.³ Galicia and Bukovina not included.⁴ Figures for 1915.⁵ Figures for 1914.⁶ Figures for 1913.⁷ Figures for 1910.⁸ Excludes territory occupied by the enemy.⁹ Figures for 1911.

WHEAT—Continued.

TABLE 12.—Wheat: Area and production of undermentioned countries, 1916–1918—Con.

Country.	Area.			Production.		
	1916	1917	1918	1916	1917	1918
ASIA.						
British India ¹	Acres. 30,320,000	Acres. 32,940,000	Acres. 35,497,000	Bushels. 323,008,000	Bushels. 379,232,000	Bushels. 379,829,000
Cyprus.....	(²)	(²)		³ 1,924,000		
Japanese Empire:						
Japan.....	1,304,000	1,393,000	1,486,000	30,137,000	34,739,000	31,127,000
Formosa.....	14,000			138,000		
Korea.....	³ 499,000			³ 6,146,000		
Persia.....	(²)			³ 16,000,000		
Russia:						
Central Asia (4 govern- ments of).....	³ 5,421,000			³ 44,132,000		
Siberia (4 governments of).....	³ 7,727,000			³ 50,308,000		
Transcaucasia (1 gov- ernment).....	³ 10,000			³ 126,000		
Total.....	13,158,000			³ 94,566,000		
Turkey (Asiatic).....				⁴ 145,519,000		
Total.....				617,438,000		
AFRICA.						
Algeria.....	3,272,000	3,222,000	3,186,000	29,151,000	23,151,000	49,199,000
Egypt.....	1,447,000	1,116,000	1,286,000	36,543,000	29,834,000	32,555,000
Tunis.....	1,482,000	1,310,000	1,413,000	7,165,000	6,963,000	8,451,000
Union of South Africa.....	785,000	755,000	925,000	6,477,000	4,790,000	8,833,000
Total.....	6,986,000			79,336,000		
AUSTRALASIA.						
Australia:						
Queensland.....	94,000	228,000		427,000	2,463,000	
New South Wales.....	4,189,000	3,806,000		68,869,000	36,585,000	
Victoria.....	3,680,000	3,126,000		60,366,000	51,162,000	
South Australia.....	2,739,000	2,778,000		35,210,000	45,745,000	
Western Australia.....	1,734,000	1,567,000		18,811,000	16,103,000	
Tasmania.....	49,000	28,000		1,025,000	348,000	
Other.....		1,000			14,000	
Total Australia.....	12,485,000	11,533,000	9,880,000	184,709,000	152,420,000	114,866,000
New Zealand.....	329,000	219,000	294,000	7,108,000	5,083,000	6,761,000
Total Australasia.....	12,814,000	11,752,000		191,817,000	157,503,000	121,627,000
Grand total.....				3,701,333,000		

¹ Includes Native States. ² No official estimates. ³ Figures for 1915. ⁴ Figures for 1911.

WHEAT—Continued.

TABLE 13.—Wheat: Total production of countries named in Table 12, 1891–1916.

Year.	Production.	Year.	Production.	Year.	Production.	Year.	Production.
	<i>Bushels.</i>		<i>Bushels.</i>		<i>Bushels.</i>		<i>Bushels.</i>
1891....	2,432,322,000	1898....	2,948,305,000	1905....	3,327,084,000	1912....	3,791,951,000
1892....	2,481,805,000	1899....	2,783,885,000	1906....	3,434,354,000	1913....	4,127,437,000
1893....	2,559,174,000	1900....	2,610,751,000	1907....	3,133,965,000	1914....	3,585,916,000
1894....	2,660,557,000	1901....	2,955,975,000	1908....	3,182,105,000	1915....	4,127,685,000
1895....	2,593,312,000	1902....	3,090,116,000	1909....	3,581,519,000	1916....	3,701,333,000
1896....	2,506,320,000	1903....	3,189,813,000	1910....	3,575,055,000		
1897....	2,236,268,000	1904....	3,163,542,000	1911....	3,551,795,000		

TABLE 14.—Wheat: Average yield per acre in undermentioned countries, 1890–1918.

Year.	United States.	Russia (European). ¹	Germany. ¹	Austria. ¹	Hungary proper. ¹	France. ²	United Kingdom. ²
Average:	<i>Bushels.</i>	<i>Bushels.</i>	<i>Bushels.</i>	<i>Bushels.</i>	<i>Bushels.</i>	<i>Bushels.</i>	<i>Bushels.</i>
1890–1899.....	13.2	8.9	24.5	16.2	18.6	18.6	31.2
1900–1909.....	14.1	9.7	28.9	18.0	17.5	20.5	33.1
1910–1914.....	14.8	10.3	31.7	20.8	18.6	19.1	32.4
1906.....	15.5	7.7	30.3	20.3	22.5	20.2	34.8
1907.....	14.0	8.0	29.6	18.0	14.9	23.2	35.1
1908.....	14.0	8.8	29.7	21.0	17.5	19.6	33.4
1909.....	15.4	12.5	30.5	19.9	14.1	22.0	35.0
1910.....	13.9	11.2	29.6	19.2	19.8	15.9	31.4
1911.....	12.5	7.0	30.6	19.6	20.9	19.8	34.0
1912.....	15.9	10.3	33.6	22.3	19.8	21.0	30.0
1913.....	15.2	13.5	35.1	19.9	19.6	19.9	32.7
1914.....	16.6	9.4	29.6	22.9	13.1	18.9	33.8
1915.....	17.0	11.6	28.6	17.8	18.4	16.6	32.7
1916.....	12.2	16.5	30.0
1917.....	14.1	13.8	31.5
1918.....	15.5

¹ Bushels of 60 pounds.

² Winchester bushels.

TABLE 15.—Wheat: Acreage, production, value, exports, etc., in the United States, 1849–1918.

NOTE.—Figures in *italics* are census returns; figures in roman are estimates of the Department of Agriculture. Estimates of acres are obtained by applying estimated percentages of increase or decrease to the published numbers of the preceding year, except that a revised base is used for applying percentage estimates whenever new census data are available.

Year.	Acreage harvested.	Average yield per acre.	Production.	Average farm price per bushel Dec. 1.	Farm value Dec. 1.	Chicago cash price per bushel, No. 1 northern spring.				Domestic exports, including flour, fiscal year beginning July 1.	Percent of crop exported.
						December.		Following May.			
						Low.	High.	Low.	High.		
1849....	<i>Acres.</i>	<i>Bush.</i>	<i>Bushels.</i>	<i>Cents.</i>	<i>Dollars.</i>	<i>Cts.</i>	<i>Cts.</i>	<i>Cts.</i>	<i>Cts.</i>	<i>Bushels.</i>	<i>P. ct.</i>
1859....	100,486,000	7,535,901	7.5
.....	173,105,000	17,213,133	9.9
1866....	15,424,000	9.9	152,000,000	152.7	232,110,000	129	145	185	211	12,646,941	8.3
1867....	18,322,000	11.6	212,441,000	145.2	308,387,000	126	140	134	161	26,323,014	12.4
1868....	18,460,000	12.1	224,037,000	108.5	243,033,000	80	88	87	96	29,717,201	13.3
1869....	19,181,000	13.6	260,147,000	76.5	199,025,000	63	76	79	92	53,900,780	20.7
1869....	287,746,000
1870....	18,993,000	12.4	235,885,000	94.4	222,767,000	91	98	113	120	52,574,111	22.3
1871....	19,944,000	11.6	230,722,000	114.5	264,076,000	107	111	120	143	38,995,755	16.9
1872....	20,858,000	12.0	249,997,000	111.4	278,522,000	97	108	112	122	52,014,715	20.8
1873....	22,172,000	12.7	281,255,000	106.9	300,670,000	96	106	105	114	91,510,398	32.5
1874....	24,967,000	12.3	308,103,000	86.3	265,881,000	78	83	78	94	72,912,817	23.7

WHEAT—Continued.

TABLE 15.—Wheat: Acreage, production, value, exports, etc., in the United States, 1849-1918—Continued.

Year.	Acreage harvested.	Average yield per acre.	Production.	Average farm price per bushel Dec. 1.	Farm value Dec. 1.	Chicago cash price per bushel, No. 1 northern spring.				Domestic exports, including flour, fiscal year beginning July 1.	Per cent of crop exported.
						December.		Following May.			
						Low.	High.	Low.	High.		
	<i>Acres.</i>	<i>Bush.</i>	<i>Bushels.</i>	<i>Cents.</i>	<i>Dollars.</i>	<i>Cts.</i>	<i>Cts.</i>	<i>Cts.</i>	<i>Cts.</i>	<i>Bushels.</i>	<i>P. ct.</i>
1875...	26,382,000	11.1	292,136,000	89.5	261,397,000	82	91	89	100	74,750,682	25.6
1876...	27,627,000	10.5	289,356,000	97.0	280,743,000	104	117	130	172	57,043,936	19.7
1877...	26,278,000	13.9	364,194,000	105.7	385,089,000	103	108	98	113	92,141,626	25.3
1878...	32,109,000	13.1	420,122,000	77.6	325,814,000	81	84	91	102	150,502,506	35.8
1879...	32,546,000	13.8	448,757,000	110.8	497,030,000	122	133½	112½	119	180,304,181	40.2
1879...	35,430,000	13.0	459,483,000
1880...	37,987,000	13.1	498,550,000	95.1	474,202,000	93½	109½	101	112½	186,321,514	37.4
1881...	37,709,000	10.2	383,280,000	119.2	456,880,000	124½	129	123	140	121,892,389	31.8
1882...	37,067,000	13.6	504,185,000	88.4	445,602,000	91½	94½	108	113½	111,811,916	29.3
1883...	36,456,000	11.6	421,086,000	91.1	383,649,000	94½	99½	85	94	111,534,182	26.5
1884...	39,476,000	13.0	512,765,000	64.5	330,862,000	69½	76½	85½	90½	132,570,366	25.9
1885...	34,189,000	10.4	357,112,000	77.1	275,320,000	82½	89	72½	79	94,565,793	26.5
1886...	36,806,000	12.4	457,218,000	68.7	314,226,000	75½	79½	80½	88½	153,804,969	33.6
1887...	37,642,000	12.1	456,329,000	68.1	310,613,000	75½	79½	81½	89	119,625,344	26.2
1888...	37,336,000	11.1	415,868,000	92.6	385,248,000	96½	105½	77½	95½	88,600,748	21.3
1889...	38,124,000	12.9	490,580,000	69.8	342,492,000	76½	80½	89½	100	109,430,467	22.3
1889...	35,580,000	13.9	468,374,000
1890...	36,087,000	11.1	399,262,000	83.8	334,774,000	87½	92½	98½	108½	106,181,316	26.6
1891...	39,917,000	15.3	611,781,000	83.9	513,473,000	89½	93½	80	85½	225,665,811	36.9
1892...	38,554,000	13.4	515,947,000	62.4	322,112,000	69½	73	68½	76½	191,912,635	37.2
1893...	34,629,000	11.4	396,132,000	53.8	213,171,000	59½	64½	52½	60½	164,283,129	41.5
1894...	34,882,000	13.2	460,267,000	49.1	225,902,000	52½	63½	60½	85½	144,812,718	31.5
1895...	34,047,000	13.7	467,103,000	50.9	237,939,000	53½	64½	57½	67½	126,443,968	27.1
1896...	34,619,000	12.4	427,684,000	72.6	310,598,000	74½	93½	68½	97½	145,124,972	33.9
1897...	39,465,000	13.4	530,149,000	80.8	428,547,000	92	109	117	185	217,306,005	41.0
1898...	44,055,000	15.3	675,149,000	58.2	392,770,000	62½	70	68½	79½	222,618,420	33.0
1899...	44,593,000	12.3	547,304,000	58.4	319,545,000	64	69½	63½	67½	186,096,762	34.0
1899...	52,589,000	12.5	658,534,000
1900...	42,495,000	12.3	522,230,000	61.9	323,515,000	69½	74½	70	75½	215,990,073	41.4
1901...	49,896,000	15.0	748,460,000	62.4	467,360,000	73	79½	72½	76½	234,772,516	31.4
1902...	46,202,000	14.5	670,063,000	63.0	422,224,000	71½	77½	74½	80½	202,905,598	30.3
1903...	49,465,000	12.9	637,822,000	69.5	443,025,000	77½	87	87½	101½	120,727,613	18.9
1904...	44,075,000	12.5	552,400,000	92.4	510,490,000	115	122	89½	113½	44,112,910	8.0
1905...	47,854,000	14.5	692,979,000	74.8	518,373,000	82½	90	84	87½	97,609,007	14.1
1906...	47,306,000	15.5	735,261,000	66.7	490,333,000	80½	106	146,700,425	20.0
1907...	45,211,000	14.0	634,887,000	87.4	554,437,000	163,043,669	25.7
1908...	47,557,000	14.0	664,602,000	92.8	616,826,000	106½	112	126½	137	114,268,468	17.2
1909...	46,723,000	15.8	737,189,000
1909...	44,262,000	15.4	683,379,000	98.6	668,680,000	106	119½	100	119½	87,364,318	12.8
1910 ¹ ...	45,681,000	13.9	635,121,000	88.3	561,051,000	104	110	98	103	69,311,760	10.9
1911...	49,543,000	12.5	621,338,000	87.4	543,063,000	105	110	115	122	79,689,404	12.8
1912...	45,814,000	15.9	730,267,000	76.0	555,280,000	85	90½	96	104	142,879,596	19.6
1913...	50,184,000	15.2	763,380,000	79.9	610,122,000	89½	93	96	100	145,590,349	19.1
1914...	53,541,000	16.6	891,017,000	98.6	878,680,000	115	131	141	164½	332,464,975	37.3
1915...	60,469,000	17.0	1,025,801,000	91.9	942,303,000	106	128½	116	126	243,117,026	23.7
1916...	52,316,000	12.2	636,318,000	160.3	1,019,968,000	155½	190	258	340	203,573,928	32.0
1917...	45,089,000	14.1	636,655,000	200.8	1,278,112,000	220	220	220	220	132,579,533	20.8
1918...	59,110,000	15.5	917,100,000	204.4	1,874,623,000	220	220	220	220

¹ Figures adjusted to census basis.

WHEAT—Continued.

TABLE 17.—Winter and spring wheat: Acreage, production, and farm value Dec. 1, by States in 1918, and United States totals, 1890–1917—Continued.

[000 omitted.]

State.	Winter wheat.						Spring wheat.				
	Acreage sown in preceding fall.	Acreage harvested.	Average yield per acre.	Production.	Average farm price Dec. 1.	Farm value Dec. 1.	Acreage.	Average yield per acre.	Production.	Average farm price Dec. 1.	Farm value Dec. 1.
1918.	<i>Acres.</i>	<i>Acres.</i>	<i>Bu.</i>	<i>Bush.</i>	<i>Cts.</i>	<i>Dollars.</i>	<i>Acres.</i>	<i>Bu.</i>	<i>Bush.</i>	<i>Cts.</i>	<i>Dollars.</i>
Tenn.....	765	750	10.0	7,500	214	16,050
Ala.....	144	140	9.5	1,330	245	3,258
Miss.....	36	30	16.5	495	250	1,238
Tex.....	1,622	892	10.0	8,920	215	19,178
Okla.....	3,264	2,611	12.6	32,899	201	66,127
Ark.....	260	254	12.0	3,048	207	6,309
Mont.....	775	682	12.0	8,184	194	15,877	1,380	12.5	17,250	194	33,465
Wyo.....	87	80	24.0	1,920	189	3,629	180	26.0	4,680	189	8,845
Colo.....	585	430	16.5	7,095	195	13,835	312	20.0	6,240	195	12,168
N. Mex.....	140	127	10.0	1,270	210	2,667	86	24.0	2,064	210	4,334
Ariz.....	44	38	26.0	988	240	2,371
Utah.....	165	160	16.6	2,656	188	4,993	160	23.8	3,808	188	7,159
Nev.....	5	5	29.0	145	206	299	37	25.0	925	206	1,906
Idaho.....	315	298	22.0	6,556	192	12,588	547	21.0	11,487	192	22,055
Wash.....	422	401	23.5	9,424	196	18,471	1,790	9.5	17,005	196	33,330
Oreg.....	650	635	17.0	10,795	201	21,698	403	11.0	4,433	201	8,910
Calif.....	633	506	15.0	7,590	216	16,394
U. S.....	42,301	36,704	15.2	558,449	206.7	1,154,200	22,406	16.0	358,651	200.9	720,423
1917.....	40,534	27,257	15.1	412,901	202.8	837,237	17,832	12.5	223,754	197.0	440,875
1916.....	39,203	34,709	13.8	480,553	162.7	781,906	17,607	8.8	155,765	152.8	238,062
1915.....	42,881	41,308	16.3	673,947	94.7	638,149	19,161	18.4	351,854	86.4	304,154
1914.....	37,128	36,008	19.0	684,990	98.6	675,623	17,533	11.8	206,027	98.6	203,057
1913.....	33,618	31,699	16.5	523,561	82.9	483,995	18,485	13.0	239,819	73.4	176,127
1912.....	33,215	26,571	15.1	399,919	80.9	323,572	19,243	17.2	330,348	70.1	231,708
1911.....	32,648	29,162	14.8	430,656	88.0	379,151	20,381	9.4	190,682	86.0	163,912
1910.....	31,656	27,329	15.9	434,142	88.1	382,318	18,352	11.0	200,979	88.9	173,733
1909 ¹	29,301	27,151	15.5	419,733	102.4	426,184	17,111	15.4	263,646	92.5	242,496
1908.....	31,646	30,349	14.4	437,908	93.7	410,330	17,208	13.2	226,694	91.1	206,496
1907.....	31,665	28,132	14.6	409,442	88.2	361,217	17,079	13.2	224,645	86.0	193,220
1906.....	31,312	29,600	16.7	492,888	68.3	336,435	17,706	13.7	242,373	63.5	153,898
1905.....	31,155	29,864	14.3	428,463	78.2	334,987	17,990	14.7	264,517	69.3	183,386
1904.....	31,654	26,866	12.4	332,935	97.8	325,611	17,209	12.8	219,464	84.2	184,879
1903.....	34,071	32,511	12.3	399,867	71.6	286,243	16,954	14.0	237,955	65.9	156,782
1902.....	32,432	28,581	14.4	411,789	64.8	266,727	17,621	14.7	258,274	60.2	155,497
1901.....	30,283	30,240	15.2	458,835	66.1	303,227	19,656	14.7	289,626	56.7	164,133
1900.....	30,883	26,236	13.3	350,025	63.3	221,668	16,259	10.6	172,204	59.1	101,847
1899.....	29,954	25,358	11.5	291,706	63.0	183,767	19,235	13.3	255,598	53.1	135,778
1898.....	27,642	25,745	14.9	382,492	62.2	237,736	18,310	16.0	292,657	53.0	155,034
1897.....	24,765	22,926	14.1	323,616	85.1	275,323	16,539	12.5	206,533	74.2	153,224
1896.....	23,383	22,794	11.8	267,934	77.0	206,270	11,825	13.5	159,750	65.3	104,328
1895.....	24,224	22,609	11.6	261,242	57.8	150,944	11,438	18.0	205,861	42.3	86,995
1894.....	21,553	23,519	14.0	329,290	49.8	164,022	11,368	11.5	130,977	47.2	61,880
1893.....	23,118	12.0	278,469	56.3	156,720	11,511	10.2	117,662	48.0	56,451
1892.....	26,209	13.7	359,416	65.1	234,037	12,345	12.7	156,531	56.3	88,075
1891.....	27,524	14.7	405,116	88.0	356,415	12,393	16.7	206,665	76.0	157,058
1890.....	24,359	10.9	255,374	87.5	223,362	12,567	11.4	143,890	77.4	111,411

¹ Census acreage and production.

WHEAT—Continued.

TABLE 18.—Winter and spring wheat: Yield per acre in States producing both, for 10 years.

WINTER WHEAT.

State.	Yield per acre (bushels).										
	10-year aver., 1909- 1918.	1909	1910	1911	1912	1913	1914	1915	1916	1917	1918
New York.....										21.0	18.0
Ohio.....										22.0	19.0
Indiana.....										18.5	21.0
Illinois.....										18.5	21.5
Michigan.....										18.0	14.0
Wisconsin.....	20.7	20.4	20.0	17.5	19.5	20.1	21.5	23.0	19.0	24.0	22.0
Minnesota.....	17.9					16.2	19.5	19.5	14.0	18.0	20.0
Iowa.....	20.8	21.6	21.2	19.7	23.0	23.4	21.6	21.5	18.5	17.5	20.5
Missouri.....										15.3	17.2
South Dakota.....	15.5					9.0	14.0	20.5	18.5	14.0	17.0
Nebraska.....	16.7	19.4	16.5	13.8	18.0	18.6	19.3	18.5	20.0	12.0	11.1
Colorado.....	13.9	14.5	14.2	10.8	15.5	13.0	20.5	12.5	12.0	12.2	14.1
Montana.....	23.3	32.5	22.0	31.7	24.5	25.6	23.0	27.0	21.5	13.0	12.0
Wyoming.....	25.2	32.5	25.0	26.0	28.0	25.0	24.0	26.0	21.0	20.0	24.0
Colorado.....	22.7	29.7	23.0	18.0	24.5	21.1	25.0	26.0	20.0	23.0	16.5
New Mexico.....	18.6		20.0	25.0	20.0	18.6	25.0	22.0	16.5	10.0	10.0
Utah.....	21.2	24.0	20.5	20.0	24.0	23.0	25.0	25.0	20.0	14.0	16.6
Nevada.....	25.6	24.0	24.0	23.0	27.5	23.0	29.0	26.0	24.5	26.0	29.0
Idaho.....	26.1	29.0	23.7	31.5	28.7	27.4	27.5	29.0	24.0	18.0	22.0
Washington.....	25.4	25.8	20.5	27.3	27.6	27.0	26.5	27.6	26.5	21.5	23.5
Oregon.....	21.9	21.0	23.7	22.2	26.8	21.4	22.0	24.0	23.0	17.5	17.0
United States....	15.8	15.8	15.9	14.8	15.1	16.5	19.0	16.3	13.8	15.1	15.2

SPRING WHEAT.

New York.....										21.0	20.0
Ohio.....											21.5
Indiana.....										20.0	23.0
Illinois.....										25.0	26.9
Michigan.....										17.7	18.1
Wisconsin.....	19.1	19.0	18.7	14.5	18.5	18.6	17.0	22.5	16.6	21.2	24.6
Minnesota.....	14.8	16.8	16.0	10.1	15.5	16.2	10.5	17.0	7.5	17.5	21.0
Iowa.....	16.6	14.7	20.9	13.8	17.0	17.0	13.5	16.7	13.0	21.5	18.0
Missouri.....										9.0	15.6
South Dakota.....	11.9	14.1	12.8	4.0	14.2	9.0	9.0	17.0	6.3	14.0	19.0
Nebraska.....	13.2	14.0	13.9	10.0	14.1	12.0	11.5	16.0	12.5	16.5	11.9
Kansas.....	9.9	11.5	8.4	4.2	15.0	8.5	15.0	12.0	10.5	6.0	8.0
Montana.....	20.4	28.8	22.0	25.2	23.5	21.5	17.0	26.0	18.0	9.0	12.5
Wyoming.....	25.1	27.0	25.0	26.0	29.2	25.0	22.0	27.0	22.0	22.0	26.0
Colorado.....	22.1	29.4	21.9	19.5	24.0	21.0	22.5	21.0	19.5	22.0	20.0
New Mexico.....	21.5	24.5	20.0	20.5	22.0	19.0	23.0	22.5	21.5	18.0	24.0
Utah.....	26.5	28.5	25.3	27.0	29.2	28.0	25.0	28.0	25.0	25.0	23.8
Nevada.....	29.8	28.7	29.0	32.5	30.2	31.0	30.0	32.0	31.5	28.0	25.0
Idaho.....	24.9	26.0	20.4	29.0	28.3	28.0	24.0	26.5	23.5	22.0	21.0
Washington.....	18.1	20.6	14.5	19.5	20.4	19.0	20.0	22.2	21.5	13.6	9.5
Oregon.....	17.2	18.7	18.0	17.7	19.5	19.5	16.5	17.0	23.0	11.0	11.0
United States....	13.4	15.8	11.0	9.4	17.2	13.0	11.8	18.4	8.8	12.5	16.0

WHEAT—Continued.

TABLE 19.—Wheat: Acreage, production, and total farm value, by States, 1917 and 1918.

State.	Thousands of acres.		Production (thousands of bushels.		Total value, basis Dec. 1 price (thousands of dollars).	
	1918	1917	1918	1917	1918	1917
Maine.....	23	11	506	154	1,199	362
Vermont.....	18	6	396	120	915	283
New York.....	430	420	7,840	8,820	16,856	18,522
New Jersey.....	100	89	1,700	1,691	3,655	3,602
Pennsylvania.....	1,454	1,399	24,718	24,482	52,897	50,188
Delaware.....	133	131	1,729	2,162	3,838	4,497
Maryland.....	732	675	11,346	11,475	24,848	23,753
Virginia.....	1,300	1,200	15,600	15,600	34,164	33,696
West Virginia.....	348	315	4,942	4,410	10,922	9,570
North Carolina.....	1,015	860	7,105	8,600	16,342	20,124
South Carolina.....	205	165	2,255	1,732	5,863	5,023
Georgia.....	356	244	3,631	2,074	9,658	6,015
Ohio.....	2,290	1,870	43,547	41,140	92,320	83,926
Indiana.....	2,353	1,807	49,427	33,432	102,808	67,867
Illinois.....	2,774	1,650	60,991	30,850	126,861	62,008
Michigan.....	754	857	10,716	15,422	22,397	31,460
Wisconsin.....	406	239	9,837	5,327	20,166	10,761
Minnesota.....	3,799	2,947	79,710	51,611	162,608	104,254
Iowa.....	1,050	420	19,650	8,350	39,300	16,616
Missouri.....	3,092	1,896	53,154	28,971	108,966	56,493
North Dakota.....	7,770	7,000	101,010	56,000	205,050	112,000
South Dakota.....	3,765	3,200	71,305	44,800	141,896	87,808
Nebraska.....	3,828	997	43,141	13,764	84,988	26,840
Kansas.....	7,248	3,737	102,008	45,443	202,996	89,977
Kentucky.....	933	750	12,129	9,000	25,956	19,080
Tennessee.....	750	500	7,500	4,600	16,050	10,212
Alabama.....	140	93	1,330	930	3,258	2,511
Mississippi.....	30	14	495	210	1,238	630
Texas.....	892	1,350	8,920	16,200	19,178	34,020
Oklahoma.....	2,611	3,100	32,899	35,650	66,127	69,161
Arkansas.....	254	195	3,048	3,120	6,309	6,271
Montana.....	2,062	1,727	25,434	17,963	49,342	34,489
Wyoming.....	260	203	6,600	4,306	12,474	8,612
Colorado.....	742	600	13,335	13,536	26,003	26,124
New Mexico.....	213	203	3,334	2,582	7,001	5,551
Arizona.....	38	33	988	825	2,371	1,732
Utah.....	320	296	6,464	5,640	12,152	10,039
Nevada.....	42	41	1,070	1,140	2,205	2,052
Idaho.....	845	756	18,043	15,332	34,643	27,904
Washington.....	2,191	1,855	26,429	29,218	51,801	56,391
Oregon.....	1,038	863	15,228	12,548	30,608	22,838
California.....	506	375	7,590	7,425	16,394	14,850
United States.....	59,110	45,089	917,100	636,655	1,874,623	1,278,112

WHEAT—Continued.

TABLE 20.—Wheat: Production and distribution in the United States, 1897–1918.

[000 omitted.]

Year.	Old stock on farms July 1.	Crop.			Total supplies.	Stock on farms Mar. 1 following.	Shipped out of county where grown.
		Quantity.	Weight per bushel.	Quality.			
	<i>Bushels.</i>	<i>Bushels.</i>	<i>Pounds.</i>	<i>Per cent.</i>	<i>Bushels.</i>	<i>Bushels.</i>	<i>Bushels.</i>
1897.....	23,347	530,149	57.1	553,496	121,320	269,126
1898.....	17,839	675,149	57.7	87.9	692,988	198,056	398,882
1899.....	64,061	547,304	56.9	83.7	611,365	158,746	305,020
1900.....	50,900	522,230	56.3	87.8	573,130	128,098	281,372
1901.....	30,552	748,460	57.5	88.8	779,012	173,353	372,717
1902.....	52,437	670,063	57.6	722,500	164,047	388,554
1903.....	42,540	637,822	57.3	680,362	132,608	369,582
1904.....	36,634	552,400	57.4	589,034	111,055	302,771
1905.....	24,257	692,979	55.5	717,236	158,403	404,092
1906.....	46,053	735,261	58.3	781,314	206,642	427,253
1907.....	54,853	634,087	58.2	89.9	688,940	148,721	367,607
1908.....	33,797	664,602	58.3	89.4	698,399	143,692	393,435
1909.....	15,062	683,379	57.9	90.4	698,441	159,100	414,166
1910.....	35,680	635,121	58.5	93.1	670,801	162,705	352,906
1911.....	34,071	621,338	57.8	88.3	655,409	122,041	348,739
1912.....	23,876	730,267	58.3	90.0	754,143	156,471	449,881
1913.....	35,515	763,380	58.7	93.2	798,895	151,795	411,733
1914.....	32,236	891,017	58.0	89.7	923,253	152,903	541,193
1915.....	28,972	1,025,801	57.9	88.4	1,054,773	244,448	633,380
1916.....	74,731	636,318	57.1	87.0	711,049	100,650	361,088
1917.....	15,611	636,655	58.5	92.4	652,266	107,745	325,500
1918.....	8,063	917,100	58.8	93.1	925,163	129,258	588,333

WHEAT—Continued.

TABLE 21.—Wheat: Yield per acre, price per bushel Dec. 1, and value per acre, by States.

State.	Yield per acre (bushels).										Farm price per bushel (cents).					Value per acre (dollars), ¹			
	10-year average, 1909-1918.	1909	1910	1911	1912	1913	1914	1915	1916	1917	1918	10-year average, 1909-1918.	1914	1915	1916	1917	1918	5-year average, 1914-1918.	1918
Me.	24.3	25.5	29.7	21.0	23.5	25.5	27.0	28.0	27.0	14.0	22.0	141	109	112	187	235	237	39.26	52.14
Vt.	25.8	25.0	29.3	27.8	25.0	24.5	29.0	30.0	25.0	20.0	22.0	136	100	107	165	236	231	40.07	50.82
N. Y.	20.8	21.0	23.7	19.5	16.0	20.0	22.5	25.0	21.0	21.0	18.2	130	108	101	168	210	215	33.61	39.13
N. J.	18.4	17.9	18.5	17.4	18.5	17.6	18.0	20.0	20.0	19.0	17.0	130	109	106	164	213	215	30.13	36.55
Pa.	17.3	17.0	17.8	13.5	18.0	17.0	18.1	18.5	19.0	17.5	17.0	127	104	104	162	205	214	28.22	36.38
Del.	16.0	14.0	17.0	16.7	17.5	14.5	20.5	15.0	15.0	16.5	13.0	128	109	109	162	208	222	25.23	28.86
Md.	16.2	14.5	17.4	15.5	15.0	13.3	21.5	16.1	16.0	17.0	15.5	128	106	105	171	207	219	27.24	33.94
Va.	12.7	11.2	12.8	12.0	11.6	13.6	14.5	13.8	12.7	13.0	12.0	132	108	108	165	216	219	21.18	26.28
W. Va.	13.7	13.0	12.5	11.5	14.5	13.0	15.0	15.0	14.5	14.0	14.2	133	108	108	160	217	221	23.47	31.38
N. C.	10.2	9.5	11.4	10.6	8.9	11.7	12.0	10.9	10.5	10.0	7.0	143	117	120	176	234	230	17.02	16.10
S. C.	10.8	10.0	11.0	11.4	9.2	12.3	11.5	10.8	10.6	10.5	11.0	167	145	138	189	290	260	22.13	28.60
Ga.	10.7	10.0	10.5	12.0	9.3	12.2	12.1	11.0	11.4	8.5	10.2	164	134	129	186	290	266	20.68	27.13
Ohio.	16.7	15.9	16.2	16.0	8.0	18.0	18.5	20.3	13.5	22.0	19.0	128	105	104	169	204	212	29.70	40.28
Ind.	15.8	15.3	15.6	14.7	8.0	18.5	17.4	17.2	12.0	18.5	21.0	125	103	102	169	203	208	27.40	43.68
Ill.	16.5	17.4	15.0	16.0	8.3	18.7	18.5	19.0	11.0	18.7	22.0	123	101	100	165	201	208	27.84	45.76
Mich.	17.0	18.8	18.0	18.0	10.0	15.3	19.7	21.3	16.6	18.0	14.2	126	103	101	167	204	209	27.18	29.68
Wis.	19.9	19.5	19.3	15.9	19.0	16.9	17.1	22.7	17.6	22.3	24.2	120	100	95	160	202	205	32.70	49.61
Minn.	14.8	16.8	16.0	10.1	15.5	16.2	10.6	17.0	7.6	17.5	21.0	119	102	90	162	202	204	23.32	42.84
Iowa.	18.8	17.0	21.0	16.4	19.8	20.6	18.0	20.0	16.3	19.9	18.7	116	96	87	156	199	200	27.55	37.40
Mo.	14.0	14.7	13.8	15.7	12.5	17.1	17.0	12.3	8.5	15.3	13.0	122	98	98	165	195	205	19.84	26.65
N. Dak.	11.1	13.7	5.0	8.0	18.0	10.5	11.2	18.2	5.5	8.0	13.0	116	101	87	152	200	203	15.58	26.39
S. Dak.	12.0	14.1	12.8	4.0	14.2	9.0	9.1	17.1	6.8	14.0	18.9	114	94	86	150	196	199	19.70	37.61
Nebr.	16.5	18.8	16.2	13.4	17.6	17.9	18.6	18.3	19.4	13.8	11.3	113	95	84	160	195	197	22.65	22.26
Kans.	13.9	14.4	14.1	10.7	15.5	13.0	20.5	12.5	12.0	12.2	14.1	117	95	89	164	198	199	20.50	28.06
Ky.	12.2	11.8	12.8	12.7	10.0	13.6	16.5	11.0	9.0	12.0	13.0	129	103	105	166	212	214	19.35	27.82
Tenn.	11.1	10.4	11.7	11.5	10.5	12.0	15.5	10.5	9.5	9.2	10.0	132	105	108	169	222	214	17.10	21.40
Ala.	11.0	10.5	12.0	11.5	10.6	11.7	13.0	12.0	9.5	10.0	9.5	154	126	125	185	270	245	19.85	23.28
Miss.	14.2	11.0	14.0	12.0	12.0	14.0	13.0	20.0	15.0	15.0	16.5	148	125	105	175	300	250	29.95	41.25
Tex.	12.8	9.1	15.0	9.4	15.0	17.5	13.0	15.5	11.0	12.0	10.0	131	99	107	173	210	215	19.04	21.50
Okla.	12.4	12.8	16.3	8.0	12.8	10.0	19.0	11.6	9.7	11.5	12.6	118	92	89	167	194	201	18.33	25.33
Ark.	12.0	11.4	13.9	10.5	10.0	13.0	13.0	12.5	8.0	16.0	12.0	125	99	101	163	201	207	19.11	24.84
Mont.	21.8	30.8	22.0	28.7	24.1	23.8	20.2	26.5	19.3	10.4	12.3	110	91	78	161	192	194	22.79	23.86
Wyo.	25.1	28.7	25.0	26.0	28.7	25.0	22.9	26.5	21.6	21.2	25.4	114	89	78	145	200	189	32.60	48.21
Colo.	22.4	29.5	22.3	18.9	24.2	21.0	23.8	24.2	19.8	22.6	18.0	112	87	80	150	193	195	29.70	35.10
N. Mex.	20.0	24.5	20.0	22.9	20.9	18.8	24.2	22.2	18.6	12.7	15.7	126	90	90	150	215	210	25.99	32.97
Ariz.	27.6	25.0	22.3	29.6	30.7	32.0	28.0	28.0	29.0	25.0	26.0	141	125	115	150	210	240	45.12	62.40
Utah.	23.1	25.9	22.1	22.3	25.7	24.2	25.5	25.7	21.2	19.1	20.2	108	86	86	152	178	188	29.56	37.98
Nev.	28.2	28.7	26.5	28.3	29.9	27.7	29.6	29.6	28.9	27.8	25.5	121	95	95	140	180	206	39.85	52.53
Idaho.	25.7	27.8	22.6	30.7	28.6	27.6	26.2	28.0	23.8	20.3	21.4	104	87	80	146	182	192	31.60	41.09
Wash.	21.0	23.2	16.9	22.7	23.5	23.2	23.5	25.7	23.7	15.8	12.1	110	100	82	143	193	196	26.53	23.72
Oreg.	20.4	20.2	22.1	21.0	25.0	21.0	20.8	22.2	23.0	14.5	14.7	111	102	84	145	182	201	25.83	29.55
Calif.	16.5	14.0	18.0	18.0	17.0	14.0	17.0	16.0	16.0	19.8	15.0	125	104	95	152	200	216	25.84	32.40
U. S.	14.9	15.8	13.9	12.5	15.9	15.2	16.6	17.0	12.2	14.1	15.5	118.7	98.6	91.9	160.3	200.8	204.4	22.31	31.71

¹ Based upon farm price Dec. 1.

WHEAT—Continued.

TABLE 22.—*Winter and spring wheat: Condition of crop, United States, on first of months named, 1890–1919.*

Year.	Winter wheat.					Spring wheat.			
	Decem-ber of pre-vious year.	April.	May.	June.	When har-vested.	June.	July.	August.	When har-vested.
	<i>P. ct.</i>	<i>P. ct.</i>	<i>P. ct.</i>	<i>P. ct.</i>	<i>P. ct.</i>	<i>P. ct.</i>	<i>P. ct.</i>	<i>P. ct.</i>	<i>P. ct.</i>
1890.....	95.3	81.0	80.0	78.1	76.2	91.3	94.4	83.2	79.7
1891.....	98.4	96.9	97.9	96.6	96.2	92.6	94.1	95.5	97.2
1892.....	85.3	81.2	84.0	88.3	89.6	92.3	90.9	87.3	81.2
1893.....	87.4	77.4	75.4	75.5	77.7	86.4	74.1	67.0	68.9
1894.....	91.5	86.7	81.4	83.2	83.9	88.0	68.4	67.1	69.9
1895.....	89.0	81.4	82.9	71.1	65.8	97.8	102.2	95.9	94.9
1896.....	81.4	77.1	82.7	77.9	75.6	99.9	93.3	78.9	73.8
1897.....	99.5	81.4	80.2	78.5	81.2	89.6	91.2	86.7	80.8
1898.....	92.6	86.7	86.5	90.8	85.7	100.9	95.0	96.5	91.7
1899.....	97.1	77.9	76.2	67.3	65.6	91.4	91.7	83.6	77.2
1900.....	97.1	82.1	88.9	82.7	80.8	87.3	55.2	56.4	56.1
1901.....	97.1	91.7	94.1	87.8	88.3	92.0	95.6	80.3	78.4
1902.....	86.7	78.7	76.4	76.1	77.0	95.4	92.4	89.7	87.2
1903.....	99.7	97.3	92.6	82.2	78.8	95.9	82.5	77.1	78.1
1904.....	86.6	76.5	76.5	77.7	78.7	93.4	93.7	87.5	66.2
1905.....	82.9	91.6	92.5	85.5	82.7	93.7	91.0	89.2	87.3
1906.....	94.1	89.1	90.9	82.7	85.6	93.4	91.4	86.9	83.4
1907.....	94.1	89.9	82.9	77.4	78.3	88.7	87.2	79.4	77.1
1908.....	91.1	91.3	89.0	86.0	80.6	95.0	89.4	80.7	77.6
1909.....	85.3	82.2	83.5	80.7	82.4	95.2	92.7	91.6	88.6
1910.....	95.8	80.8	82.1	80.0	81.5	92.8	61.6	61.0	63.1
1911.....	82.5	83.3	86.1	80.4	76.8	94.6	73.8	59.8	56.7
1912.....	86.6	80.6	79.7	74.3	73.3	95.8	89.3	90.4	90.8
1913.....	93.2	91.6	91.9	83.5	81.6	93.5	73.8	74.1	75.3
1914.....	97.2	95.6	95.9	92.7	94.1	95.5	92.1	75.5	68.0
1915.....	88.3	88.8	92.9	85.8	84.4	94.9	93.3	93.4	94.6
1916.....	87.7	78.3	82.4	73.2	75.7	88.2	89.0	63.4	48.6
1917.....	85.7	63.4	73.2	70.9	75.9	91.6	83.6	68.7	71.2
1918.....	79.3	78.6	86.4	83.8	79.5	95.2	86.1	79.6	82.1
1919.....	98.6								

TABLE 23.—*Winter wheat: Per cent of area sown which was abandoned (not harvested).*

Year.	Per cent.	Year.	Per cent.	Year.	Per cent.
1902.....	15.2	1908.....	4.2	1914.....	3.1
1903.....	2.8	1909.....	7.5	1915.....	2.7
1904.....	15.4	1910.....	13.7	1916.....	11.4
1905.....	4.6	1911.....	10.7	1917.....	31.0
1906.....	5.5	1912.....	20.1	1918.....	13.7
1907.....	11.2	1913.....	4.7		

TABLE 24.—*Wheat: Farm price, cents per bushel on first of each month, 1909–1918.*

Date.	1918	1917	1916	1915	1914	1913	1912	1911	1910	1909	Average.
Jan. 1.....	201.9	150.3	102.8	107.8	81.0	76.2	88.0	88.6	103.4	93.5	109.4
Feb. 1.....	201.2	164.8	113.9	129.9	81.6	79.9	90.4	89.8	105.0	95.2	115.2
Mar. 1.....	202.7	164.4	102.9	133.6	83.1	80.6	90.7	85.4	105.1	103.9	115.2
Apr. 1.....	202.6	180.0	98.6	131.7	84.2	79.1	92.5	83.8	104.5	107.0	116.4
May 1.....	203.6	245.9	102.5	139.6	83.9	80.9	99.7	84.6	99.9	115.9	125.6
June 1.....	202.5	248.5	100.0	131.5	84.4	82.7	102.8	86.3	97.6	123.5	126.0
July 1.....	203.2	220.1	93.0	102.8	76.9	81.4	99.0	84.3	95.3	120.8	117.7
Aug. 1.....	204.5	228.9	107.1	106.5	76.5	77.1	89.7	82.7	98.9	107.1	117.9
Sept. 1.....	205.6	209.7	131.2	95.0	93.3	77.1	85.8	84.8	95.8	95.2	117.4
Oct. 1.....	205.8	200.6	136.3	90.9	93.5	77.9	83.4	84.8	93.7	94.6	116.5
Nov. 1.....	206.0	200.0	158.4	93.1	97.2	77.0	83.8	91.5	90.5	99.9	119.7
Dec. 1.....	204.4	200.8	160.3	91.9	98.6	79.9	76.0	87.4	88.3	98.6	118.6
Average.....	204.3	200.8	125.9	105.2	88.4	78.4	87.4	86.9	96.5	101.3	117.5

WHEAT—Continued.

TABLE 25.—Wheat: Wholesale price per bushel, 1913-1918—Continued.

Date.	New York.			Baltimore.			Chicago.			Detroit.			St. Louis.			Minneapolis.			San Francisco.		
	No. 2 red winter. ¹			No. 2 red.			No. 1 northern spring.			No. 2 red.			No. 2 red winter.			No. 1 northern			White (per 100 lbs.)		
	Low.	High.	Average.	Low.	High.	Average.	Low.	High.	Average.	Low.	High.	Average.	Low.	High.	Average.	Low.	High.	Average.	Low.	High.	Average.
1918.	<i>Cts.</i>	<i>Cts.</i>	<i>Cts.</i>	<i>Cts.</i>	<i>Cts.</i>	<i>Cts.</i>	<i>Cts.</i>	<i>Cts.</i>	<i>Cts.</i>	<i>Cts.</i>	<i>Cts.</i>	<i>Cts.</i>	<i>Cts.</i>	<i>Cts.</i>	<i>Cts.</i>	<i>Cts.</i>	<i>Cts.</i>	<i>Cts.</i>	<i>Cts.</i>	<i>Cts.</i>	<i>Cts.</i>
January.....	229	229	229.0	222	224	223.0	220	220	220.0	217	219	218.0	215	215	215.0	215	215	215.0	350	350	350.0
February.....	228	229	228.5	222	227	225.0	220	220	220.0	217	219	218.0	215	215	215.0	215	217	216.0	350	350	350.0
March.....	228	228	228.0	227	227	227.0	220	220	220.0	217	219	218.0	215	215	215.0	217	217	217.0	350	350	350.0
April.....	228	228	228.0	227	227	227.0	220	220	220.0	217	217	217.0	215	215	215.0	217	217	217.0	350	350	350.0
May.....	228	228	228.0	227	227	227.0	220	220	220.0	217	217	217.0	215	215	215.0	217	217	217.0	350	350	350.0
June.....	228	228	228.0	227	227	227.0	220	220	220.0	217	217	217.0	215	215	215.0	217	217	217.0	350	350	350.0
Jan.-June.....	228	229	228.2	222	227	226.0	220	220	220.0	217	219	217.5	215	215	215.0	215	217	216.5	350	350	350.0
July.....	229	240½	234.3	233½	235¾	235.2	226	232	229.4	217	228	224.4	221	235	224.1	221½	238	232.9	350	350	350.0
August.....	240½	240½	240.5	230	235¾	235.8	226	234	227.2	220½	223	221.8	221	224	221.6	222½	235	228.9	350	350	350.0
September.....	240½	240½	240.5	235¾	235¾	235.8	226	229	226.8	219	222	220.2	221	226½	221.8	222	222	222.0	350	350	350.0
October.....	240½	240½	240.5	235¾	235¾	235.8	226	228	226.8	222	223½	222.7	221	224½	220.0	221½	222	221.6	350	350	350.0
November.....	240½	240½	240.5	235¾	235¾	235.8	226	229	227.2	223½	224	223.7	221	228	222.7	222	223½	222.5	350	350	350.0
December.....	240½	240½	240.5	235¾	235¾	235.8	226	231	228.1	224	230	228.1	225½	248½	234.9	221½	223	222.5	350	350	350.0
July-Dec.....	229	240½	239.5	230	235¾	235.7	226	234	227.6	217	230	223.5	221	248½	224.2	221½	238	225.1	350	350	350.0

¹ No. 1 northern spring 1916-1918.

WHEAT—Continued.

TABLE 26.—Wheat flour: Wholesale price per barrel, 1913–1918.

Date.	Chicago.						Cincinnati.			New York.			St. Louis.		
	Winter patents.			Spring patents.			Winter patents.			Spring patents.			Winter patents.		
	Low.	High.	Average.	Low.	High.	Average.	Low.	High.	Average.	Low.	High.	Average.	Low.	High.	Average.
1913.															
Jan.–June.....	4.30	5.10	4.10	5.60	3.25	4.15	4.40	5.00	4.30	5.15
July–Dec.....	3.90	4.35	4.00	5.50	2.90	3.50	4.40	5.00	3.70	4.55
1914.															
Jan.–June.....	3.50	4.40	4.00	5.50	3.20	3.50	4.50	5.10	3.35	4.35
July–Dec.....	3.45	5.50	4.00	6.90	3.05	4.90	4.35	7.00	3.35	5.70
1915.															
Jan.–June.....	5.10	7.80	5.50	6.75	4.75	6.65	5.50	8.25	5.10	7.50
July–Dec.....	4.50	5.75	4.50	6.90	4.65	5.65	4.90	7.25	4.60	5.90
1916.															
Jan.–June.....	5.00	6.80	5.00	6.85	4.50	5.50	5.45	7.25	4.75	6.10
July–Dec.....	5.10	8.65	5.20	9.75	4.50	8.75	5.50	10.00	4.75	9.00
1917.															
January.....	8.20	9.50	9.10	10.00	7.25	8.75	8.85	10.20	8.15	9.00
February.....	8.10	8.40	8.20	9.80	7.75	8.50	8.65	9.25	7.90	8.70
March.....	8.20	9.50	8.50	10.20	8.00	9.00	9.40	10.40	8.40	9.25
April.....	9.75	12.50	10.00	13.30	8.50	12.50	10.15	13.75	8.60	13.25
May.....	14.75	17.00	14.25	17.80	12.00	15.25	13.50	16.75	12.50	15.25
June.....	13.00	14.65	11.25	15.60	11.00	13.75	12.25	14.75	10.50	13.50
January–June.....	8.10	17.00	8.20	17.80	7.25	15.25	8.65	16.75	7.90	15.25
July.....	10.50	12.50	11.25	14.00	10.50	11.50	11.75	13.75	9.80	11.75
August.....	11.75	12.40	12.00	14.00	9.50	11.50	12.00	13.50	10.00	11.75
September.....	9.85	10.65	10.50	12.00	9.50	10.00	11.25	12.25	10.15	10.50
October.....	10.00	10.65	10.40	11.40	9.90	10.00	10.85	12.00	9.95	10.50
November.....	13.00	10.50	10.20	10.85	9.70	9.90	10.65	11.55	10.00	10.40
December.....	13.30	10.50	10.30	10.70	9.70	9.70	10.45	11.35	10.20	10.50
July–December.....	9.85	12.50	10.20	14.00	9.50	11.50	10.45	13.75	9.80	11.75
1918.															
January.....	10.10	10.75	10.62	10.20	10.70	10.70	10.70	11.00	10.73	10.55	10.70	10.62	10.25	10.90	10.36
February.....	10.25	11.00	10.49	10.50	11.00	10.72	10.80	11.15	10.91	10.55	11.00	10.68	10.40	11.25	10.69
March.....	10.50	10.80	10.70	10.65	11.75	10.86	10.80	11.35	11.10	10.55	11.25	10.96	10.60	11.25	10.56
April.....	10.70	10.80	10.75	11.25	11.75	11.50	10.90	11.35	11.12	10.75	11.25	11.00	10.50	12.50	11.18
May.....	10.40	10.80	10.68	10.50	11.75	11.19	10.75	11.35	11.05	10.75	11.20	10.98	10.00	11.80	10.94
June.....	10.40	11.25	10.68	10.10	11.25	10.77	10.75	11.25	11.00	10.75	11.20	10.87	10.40	11.20	10.72
January–June.....	10.10	11.25	10.65	10.10	11.75	10.96	10.70	11.35	10.98	10.55	11.25	10.98	10.00	12.50	10.74
July.....	10.40	10.87	10.66	10.50	11.72	11.30	10.75	11.25	11.00	10.75	11.95	11.42	9.50	11.00	10.12
August.....	10.60	10.87	10.73	11.25	11.72	11.35	10.75	11.25	11.00	10.90	11.50	11.28	8.89	10.30	9.60
September.....	10.50	10.90	10.69	11.25	11.37	11.30	10.75	11.25	11.00	10.75	11.75	11.07	9.05	10.50	9.65
October.....	13.25	10.90	10.58	11.00	11.35	11.18	10.75	11.25	10.91	10.50	11.25	10.89	9.05	10.50	9.49
November.....	10.30	10.90	10.50	10.00	11.35	10.77	10.35	11.00	10.60	13.50	11.10	10.79	9.10	10.60	9.58
December.....	9.80	10.90	10.47	9.80	11.00	10.67	10.35	11.25	10.82	10.50	11.10	10.88	9.40	11.65	9.79
July–December.....	9.80	10.90	10.60	9.80	11.72	11.10	10.35	11.25	10.89	10.50	11.95	11.06	8.89	11.65	9.70

WHEAT—Continued.

TABLE 27.—Wheat and flour: International trade calendar years 1909–13, 1916–17.

["Temporary" imports into Italy of wheat, to be used for manufacturing products for export, are included in the total imports as given in the official Italian returns. In the trade returns of Chile the item *trigo mote* (prepared corn) which might easily be confused with *trigo* (wheat) is omitted. See "General note," Table 11.]

EXPORTS.

[000 omitted.]

Country.	Wheat.			Wheat flour.			Wheat and flour.		
	Average 1909-1913	1916 (Prelim.)	1917 (Prelim.)	Average 1909-1913	1916 (Prelim.)	1917 (Prelim.)	Average 1909-1913	1916 (Prelim.)	1917 (Prelim.)
FROM—	<i>Bushels.</i>	<i>Bushels.</i>	<i>Bushels.</i>	<i>Barrels.</i>	<i>Barrels.</i>	<i>Barrels.</i>	<i>Bushels.</i>	<i>Bushels.</i>	<i>Bushels.</i>
Argentina.....	89,102	84,321	1,365	1,623	95,243	91,625
Australia.....	41,997	55,279	1,719	3,000	49,732	68,780
Austria-Hungary.....	36	193	906
Belgium.....	19,607	686	22,694
British India.....	48,781	23,986	607	2,422	51,510	27,323
Bulgaria.....	8,840	534	11,244
Canada.....	74,247	191,218	146,874	3,694	7,921	8,771	90,871	226,862	186,342
Chile.....	2,221	83	2,593
Germany.....	12,214	1,986	21,149
Netherlands.....	53,397	1	222	10	54,391	44
Roumania.....	49,106	725	52,370
Russia.....	155,752	8,656	1,337	1,440	161,766	15,134
United States.....	553,316	154,050	106,202	10,443	14,379	13,920	100,310	218,755	168,841
Other countries.....	16,210	3,154	30,412
Total.....	624,827	26,748	745,194

IMPORTS.

INTO—									
Belgium.....	73,826	31	73,967
Brazil.....	12,283	15,574	1,825	1,329	20,495	21,553
British South Africa.....	3,425	3,772	2,586	729	452	283	6,708	5,805	3,885
Denmark.....	4,088	2,100	583	344	6,711	3,649
France.....	38,172	82,841	117	5,246	38,698	106,447
Germany.....	88,982	172	89,755
Greece.....	6,973	13	7,034
Italy.....	52,775	67,260	70,400	15	1,517	1,522	52,866	74,088	77,249
Japan.....	2,629	644	192	10	3,495	687
Netherlands.....	66,896	27,651	2,168	576	76,653	30,242
Portugal.....	3,228	3,228
Spain.....	4,468	11,576	1,858	1	16	4,471	11,648	1,861
Sweden.....	6,771	82	7,140
Switzerland.....	16,558	21,971	517	18,885	21,971
United Kingdom.....	192,134	186,425	6,005	5,646	219,156	217,476
Other countries.....	21,790	11,070	71,574
Total.....	594,998	23,520	700,836

OATS.

TABLE 28.—Oats: Area and production in undermentioned countries, 1916–1918.

Country.	Area.			Production.		
	1916	1917	1918	1916	1917	1918
NORTH AMERICA.						
United States.....	<i>Acres.</i> 41,527,000	<i>Acres.</i> 43,553,000	<i>Acres.</i> 44,400,000	<i>Bushels.</i> 1,251,837,000	<i>Bushels.</i> 1,592,740,000	<i>Bushels.</i> 1,538,359,000
Canada:						
New Brunswick.....	198,000	190,000	224,000	6,039,000	4,275,000
Quebec.....	1,073,000	1,493,000	1,933,000	24,411,000	32,466,000
Ontario.....	1,991,000	2,687,000	2,924,000	50,771,000	98,075,000
Manitoba.....	1,444,000	1,500,000	1,715,000	48,439,000	45,375,000
Saskatchewan.....	3,792,000	4,522,000	4,988,000	163,278,000	123,214,000
Alberta.....	2,124,000	2,532,000	2,652,000	102,199,000	86,289,000
Other.....	374,000	383,000	354,000	15,074,000	13,316,000
Total Canada.....	10,996,000	13,313,000	14,790,000	410,211,000	403,010,000	380,274,000
Mexico.....	(1)	2 15,000
Total.....	1,662,063,000
SOUTH AMERICA.						
Argentina.....	2,565,000	2,525,000	3,200,000	75,280,000	31,781,000	75,783,000
Chile.....	161,000	6,350,000
Uruguay.....	105,000	142,000	156,000	2,283,000	1,926,000
Total.....	2,831,000	83,913,000
EUROPE.						
Austria-Hungary:						
Austria ³	4 2,663,000	4 57,625,000
Hungary proper.....	4 2,664,000	4 80,925,000
Croatia-Slavonia.....	6 256,000	4 5,000,000
Bosnia-Herzegovina.....	6 299,000	4 4,000,000
Total Austria-Hungary.....	5,882,000	4 147,550,000
Belgium.....	6 686,000	(1)
Bulgaria.....	6 379,000	7,372,000
Denmark.....	1,042,000	981,000	981,000	51,656,000	37,653,000
Finland.....	7 987,000	6 19,572,000
France ⁸	7,777,000	7,706,000	7,227,000	277,179,000	237,426,000
Germany.....	4 11,404,000	4 412,400,000
Italy.....	1,103,000	1,107,000	1,211,000	26,076,000	33,889,000	41,336,000
Luxemburg.....	69,000	56,000	48,000	2,720,000	2,015,000	1,459,000
Netherlands.....	343,000	371,000	356,000	22,240,000	18,594,000	17,182,000
Norway.....	307,000	356,000	343,000	13,502,000	14,591,000
Roumania.....	1,068,000	28,935,000
Russia:						
Russia proper ⁸	34,706,000	843,249,000
Poland.....	6 2,981,000	6 84,412,000
Northern Caucasia.....	4 985,000	4 25,267,000
Total.....	38,672,000	952,928,000
Serbia.....	5 972,000	4 4,000,000
Spain.....	1,398,000	1,425,000	1,507,000	32,163,000	33,048,000	30,474,000
Sweden.....	1,954,000	1,929,000	1,785,000	93,089,000	70,754,000	64,684,000
United Kingdom:						
England.....	1,862,000	2,013,000	77,676,000	80,981,000
Wales.....	222,000	246,000	8,237,000	8,678,000
Scotland.....	991,000	1,041,000	37,362,000	44,949,000
Ireland.....	1,072,000	1,464,000	52,774,000	80,119,000
Total United Kingdom.....	4,147,000	4,764,000	176,049,000	214,727,000	309,564,000
Total.....	77,449,000	2,267,431,000

¹ No official statistics.

² Data for 1907.

³ Galicia and Bukowina not included.

⁴ Data for 1915.

⁵ Data for 1913.

⁶ Data for 1914.

⁷ Data for 1910.

⁸ Excludes territory occupied by the enemy.

OATS—Continued.

TABLE 28.—Oats: Area and production in undermentioned countries, 1916–1918—Contd.

Country.	Area.			Production.		
	1916	1917	1918	1916	1917	1918
ASIA.						
Cyprus.....	<i>Acres.</i> (1)	<i>Acres.</i>	<i>Acres.</i>	<i>Bushels.</i> 2 405,000	<i>Bushels.</i>	<i>Bushels.</i>
Russia:						
Central Asia (4 govern- ments of).....	2 986,000			2 16,422,000		
Siberia (4 governments of).....	2 5,161,000			2 68,381,000		
Transcaucasia (1 govern- ment of).....	2 2,000			2 36,000		
Total.....	6,149,000			84,839,000		
Total.....				85,244,000		
AFRICA.						
Algeria.....	536,000	682,000	588,000	13,140,000	16,125,000	26,564,000
Tunis.....	164,000	124,000	148,000	2,067,000	3,996,000	3,858,000
Union of South Africa.....	(1)	250,000	257,000		6,928,000	
Total.....	700,000			15,207,000		
Total.....						
AUSTRALASIA.						
Australia:						
Queensland.....	(3)	7,000		2,000	109,000	
New South Wales.....	58,000	67,000		1,344,000	1,083,000	
Victoria.....	354,000	442,000		9,329,000	8,289,000	
South Australia.....	127,000	152,000		2,134,000	1,840,000	
Western Australia.....	104,000	122,000		1,538,000	1,689,000	
Tasmania.....	78,000	55,000		2,189,000	1,006,000	
Total Australia.....	722,000	844,000		16,539,000	14,018,000	9,850,000
New Zealand.....	213,000	177,000		7,653,000	5,371,000	4,943,000
Total Australasia.....	935,000	1,021,000		24,192,000	19,389,000	
Total.....						
Grand total.....				4,138,050,000		

1 No official statistics.

2 Data for 1915.

3 Less than 500 acres.

4 Including "Territories."

TABLE 29.—Oats: Total production in countries named in Table 28, 1895–1916.

Year.	Production.	Year.	Production.	Year.	Production.	Year.	Production.
	<i>Bushels.</i>		<i>Bushels.</i>		<i>Bushels.</i>		<i>Bushels.</i>
1895.....	3,008,154,000	1901.....	2,862,615,000	1907.....	3,603,396,000	1913.....	4,697,437,000
1896.....	2,847,115,000	1902.....	3,626,303,000	1908.....	3,591,012,000	1914.....	4,034,857,000
1897.....	2,633,971,000	1903.....	3,378,034,000	1909.....	4,312,882,000	1915.....	4,362,713,000
1898.....	2,903,974,000	1904.....	3,611,302,000	1910.....	4,182,410,000	1916.....	4,138,050,000
1899.....	3,256,256,000	1905.....	3,510,167,000	1911.....	3,808,561,000		
1900.....	3,166,002,000	1906.....	3,544,961,000	1912.....	4,617,394,000		

TABLE 30.—Oats: Average yield per acre in undermentioned countries, 1890–1918.

Year.	United States.	Russia (European). ¹	Germany. ¹	Austria. ¹	Hungary proper. ¹	France. ²	United Kingdom. ²
Average:							
1890–1899.....	<i>Bushels.</i> 26.1	<i>Bushels.</i> 17.8	<i>Bushels.</i> 40.0	<i>Bushels.</i> 25.3	<i>Bushels.</i>	<i>Bushels.</i> 29.8	<i>Bushels.</i> 43.6
1900–1909.....	29.3	20.0	50.7	29.8	30.7	31.6	44.3
1910–1914.....	30.5	21.8	54.7	37.5	31.9	31.0	42.9
1906.....	31.2	15.1	55.7	34.1	34.2	27.0	43.8
1907.....	29.7	19.7	58.3	35.7	30.0	31.8	45.1
1908.....	25.0	20.1	50.2	32.0	26.8	29.6	43.5
1909.....	28.6	25.7	59.0	37.4	33.8	34.1	45.9
1910.....	31.6	22.5	51.3	31.5	26.8	29.8	44.3
1911.....	24.4	18.6	49.6	33.7	33.8	30.8	41.5
1912.....	37.4	23.6	54.1	36.2	31.1	31.9	41.7
1913.....	29.2	26.3	61.1	39.3	34.6	31.6	43.0
1914.....	29.7	17.9	57.4	46.6	33.2	31.0	44.0
1915.....	37.8	22.4	36.2	21.6	30.4	25.6	44.3
1916.....	30.1					30.2	42.5
1917.....	36.6					1 36.8	45.1
1918.....	34.6						

¹ Bushels of 32 pounds.² Winchester bushels.

OATS—Continued.

TABLE 31.—Oats: Acreage, production, value, exports, etc., in the United States, 1849—1918.

NOTE.—Figures in *italics* are census returns; figures in roman are estimates of the Department of Agriculture. Estimates of acres are obtained by applying estimated percentages of increase or decrease to the published numbers of the preceding year, except that a revised base is used for applying percentage estimates whenever new census data are available.

Year.	Acreage.		Average yield per acre.	Production.	Average farm price per bushel Dec. 1.	Farm value, Dec. 1.	Chicago cash price per bushel, contract. ¹				Domestic exports, including oatmeal, fiscal year beginning July 1. ²	Imports, during fiscal year beginning July 1. ³	
	Acres.	Bush.					December.		Following May.				
			Low.	High.	Low.	High.							
1849				<i>146,584,000</i>									
1850				<i>172,643,000</i>									
1856	8,864,000	30.2	268,141,000	35.1	94,058,000	36	43	59	78	825,895	778,198		
1857	10,082,000	27.6	278,698,000	44.5	123,903,000	52	57½	62½	62½	122,554	780,798		
1858	9,666,000	26.4	254,961,000	41.7	106,356,000	43	49½	56½	62½	481,871	326,659		
1859	9,461,000	30.5	288,334,000	38.0	109,522,000	40	44½	46½	53½	121,517	2,266,785		
1869			<i>232,107,000</i>										
1870	8,792,000	28.1	247,277,000	39.0	96,444,000	37½	41	47½	51	147,572	599,514		
1871	8,366,000	30.6	255,743,000	36.2	92,591,000	30½	33	34½	42½	262,975	535,250		
1872	9,001,000	30.2	271,747,000	29.9	81,304,000	23½	25½	30	34	714,072	225,555		
1873	9,752,000	27.7	270,340,000	34.6	93,474,000	34	40½	44	48½	812,873	191,802		
1874	10,897,000	22.1	240,369,000	47.1	113,134,000	51½	54½	57½	64½	504,770	1,600,400		
1875	11,915,000	29.7	354,318,000	32.0	113,441,000	29½	30½	28½	31½	1,466,228	121,547		
1876	13,359,000	24.0	320,884,000	32.4	103,845,000	31½	34½	37½	45½	2,854,128	41,597		
1877	12,826,000	31.7	406,394,000	28.4	115,546,000	24½	27	23	27	3,715,479	21,391		
1878	13,176,000	31.4	413,579,000	24.6	101,752,000	19½	20½	24½	30½	5,452,136	13,995		
1879	12,684,000	28.7	363,761,000	33.1	120,533,000	32½	36½	29½	34½	766,366	489,576		
1879	<i>16,145,000</i>	<i>25.3</i>	<i>407,859,000</i>										
1880	16,185,000	25.8	417,885,000	36.0	150,244,000	29½	33½	36½	39½	402,904	64,412		
1881	16,832,000	24.7	416,481,000	46.4	193,199,000	43½	46½	48½	56½	625,690	1,850,980		
1882	18,495,000	26.4	488,251,000	37.5	182,978,000	34½	41½	38½	42½	461,966	815,017		
1883	20,325,000	28.1	571,302,000	32.7	187,040,000	29½	36½	30½	34½	3,274,622	121,069		
1884	21,301,000	27.4	583,628,000	27.7	161,528,000	22½	25½	34½	37	6,203,104	94,310		
1885	22,784,000	27.6	629,409,000	29.8	179,632,000	27	29	26½	29½	7,311,306	149,480		
1886	23,655,000	26.4	624,134,000	28.5	186,138,000	25½	27½	25½	27½	1,374,635	139,575		
1887	25,921,000	25.4	659,618,000	30.4	200,700,000	28½	30½	32½	38	573,080	123,817		
1888	26,998,000	26.0	701,735,000	27.8	195,424,000	25	26½	21½	23½	1,191,471	131,501		
1889	27,462,000	27.4	751,515,000	22.9	171,781,000	20	21	24½	30	15,107,238	153,232		
1889	<i>28,321,000</i>	<i>28.6</i>	<i>407,859,000</i>										
1890	26,431,000	19.8	523,621,000	42.4	222,048,000	39½	43½	45½	54	1,382,836	41,848		
1891	25,582,000	28.9	738,394,000	31.5	232,312,000	31½	33½	28½	33½	10,586,644	47,782		
1892	27,064,000	24.4	661,035,000	31.7	209,254,000	25½	31½	28½	32½	2,700,793	49,433		
1893	27,273,000	23.4	638,855,000	29.4	187,576,000	27½	29½	32½	36	6,290,229	31,759		
1894	27,024,000	24.5	662,037,000	32.4	214,817,000	28½	29½	27½	30½	1,708,824	330,318		
1895	27,878,000	29.6	824,444,000	19.9	163,655,000	16½	17½	18	19½	15,156,618	66,602		
1896	27,566,000	25.7	807,346,000	18.7	132,485,000	16½	18½	16½	18½	37,725,083	131,204		
1897	25,739,000	27.2	698,768,000	21.2	147,975,000	21	23½	26	32	73,880,307	25,093		
1898	25,777,000	28.4	730,907,000	25.5	186,405,000	26	27½	24	27½	33,534,362	28,098		
1899	26,341,000	30.2	796,178,000	24.9	198,168,000	22½	23	21½	23½	45,048,857	54,576		
1899	<i>29,540,000</i>	<i>31.9</i>	<i>943,389,000</i>										
1900	27,365,000	29.6	809,126,000	25.8	208,669,000	21½	22½	27½	31	42,268,931	32,107		
1901	28,541,000	25.8	736,809,000	39.9	293,659,000	42	48½	41	49	13,277,612	38,978		
1902	28,653,000	34.5	987,843,000	30.7	303,585,000	29½	32	33½	38½	8,381,805	150,065		
1903	27,638,000	28.4	784,094,000	34.1	267,662,000	34½	38	39½	44½	1,960,740	183,983		
1904	27,843,000	32.1	894,596,000	31.3	279,900,000	28½	32	28½	32	8,394,692	55,699		
1905	28,047,000	34.0	953,216,000	29.1	277,048,000	29½	32½	32½	34½	48,434,541	40,025		
1906	30,959,000	31.2	964,905,000	31.7	306,293,000	33	35½	44½	48½	6,386,334	91,289		
1907	31,837,000	25.0	754,443,000	44.3	334,588,000	46	50½	52½	56½	2,518,855	383,418		
1908	32,344,000	25.7	807,156,000	47.2	381,171,000	48½	50½	56½	62½	2,333,817	6,691,700		
1909	33,204,000	30.3	1,007,353,000										
1909	<i>35,139,000</i>	<i>28.6</i>	<i>1,007,143,000</i>	40.2	405,121,000	40	45	36½	43½	2,548,726	1,034,511		
1910	37,548,000	31.6	1,186,341,000	34.4	408,388,000	31	32½	31½	36	3,845,850	107,318		
1911	37,763,000	24.4	922,298,000	45.0	414,663,000	46½	47½	50½	58	2,677,749	2,622,357		
1912	37,917,000	37.4	1,418,337,000	31.9	452,469,000	31	31½	35½	43	36,455,474	723,899		
1913	38,399,000	29.2	1,121,768,000	39.2	439,596,000	37	40½	37	42½	2,748,743	22,273,624		
1914	38,442,000	29.7	1,141,060,000	43.8	499,431,000	46½	49½	50½	56	100,608,272	630,722		
1915	40,996,000	37.8	1,549,030,000	36.1	659,506,000	40½	44	39½	49	98,960,481	665,314		
1916	41,527,000	30.1	1,251,837,000	52.4	655,928,000	46½	54	59½	74	95,105,698	761,644		
1917	43,553,000	36.6	1,592,740,000	66.6	1,061,474,000	70½	80½	72	79	125,134,576	2,591,977		
1918	44,400,000	34.6	1,538,359,000	71.0	1,092,423,000	68	74½						

¹ Quotations are for No. 2 to 1906. ² Oatmeal not included 1867 to 1882, inclusive, and 1909. ³ Oatmeal not included 1866 to 1882, inclusive. ⁴ Figures adjusted to census basis.

OATS—Continued.

TABLE 32.—Oats: Revised acreage, production, and farm value, 1879 and 1889–1909.

[See head note of Table 4.]

Year.	Acreage.	Average yield per acre.	Production.	Average farm price per bushel Dec. 1.	Farm value Dec. 1.
	<i>Acres.</i>	<i>Bushels.</i>	<i>Bushels.</i>	<i>Cents.</i>	<i>Dollars.</i>
1879.....	16, 145, 000	27.9	450, 745, 000	33.3	150, 178, 000
1881.....	28, 321, 000	28.3	801, 583, 000	21.9	175, 801, 000
1890.....	28, 102, 000	20.4	572, 665, 000	41.6	238, 345, 000
1891.....	27, 604, 000	30.4	838, 876, 000	30.6	256, 814, 000
1892.....	28, 023, 000	24.8	695, 267, 000	31.5	218, 954, 000
1893.....	28, 452, 000	23.8	676, 154, 000	29.1	196, 505, 000
1894.....	28, 362, 000	25.2	715, 559, 000	32.1	229, 538, 000
1895.....	29, 379, 000	30.2	885, 900, 000	19.4	172, 186, 000
1896.....	29, 645, 000	26.3	789, 563, 000	18.3	143, 192, 000
1897.....	28, 353, 000	27.9	791, 591, 000	20.8	164, 886, 000
1898.....	28, 763, 000	29.3	842, 747, 000	25.2	212, 482, 000
1899.....	29, 540, 000	31.3	925, 555, 000	24.5	226, 588, 000
1900.....	30, 290, 000	29.9	904, 566, 000	25.4	230, 160, 000
1901.....	29, 894, 000	26.0	778, 531, 000	40.0	311, 374, 000
1902.....	30, 578, 000	34.5	1, 055, 441, 000	30.6	322, 944, 000
1903.....	30, 866, 000	27.5	848, 824, 000	33.8	286, 879, 000
1904.....	31, 353, 000	32.1	1, 007, 183, 000	31.0	312, 467, 000
1905.....	32, 072, 000	33.3	1, 068, 780, 000	28.8	308, 086, 000
1906.....	33, 353, 000	31.0	1, 034, 623, 000	31.8	329, 142, 000
1907.....	33, 641, 000	24.0	807, 308, 000	44.3	357, 340, 000
1908.....	34, 095, 000	24.9	847, 109, 000	47.3	400, 363, 000
1909.....	35, 159, 000	30.4	1, 068, 289, 000	40.6	433, 869, 000

TABLE 33.—Oats: Acreage, production, and total farm value, by States, 1917 and 1918.

State.	Thousands of acres.		Production (thousands of bushels).		Total value, basis Dec. 1 price (thousands of dollars).	
	1918	1917	1918	1917	1918	1917
Maine.....	169	120	6, 760	3, 480	6, 084	2, 958
New Hampshire.....	24	17	912	646	793	543
Vermont.....	103	82	4, 223	2, 952	3, 801	2, 509
Massachusetts.....	12	7	480	259	437	210
Rhode Island.....	2	2	84	62	76	46
Connecticut.....	24	18	912	594	821	469
New York.....	1, 260	1, 200	51, 660	42, 090	43, 394	31, 500
New Jersey.....	85	75	3, 400	2, 550	2, 686	1, 785
Pennsylvania.....	1, 210	1, 150	47, 190	40, 250	37, 752	29, 382
Delaware.....	5	4	175	128	152	100
Maryland.....	60	47	1, 980	1, 457	1, 703	1, 093
Virginia.....	225	225	5, 175	5, 512	5, 175	4, 630
West Virginia.....	160	125	4, 320	3, 375	3, 931	2, 666
North Carolina.....	325	275	6, 500	4, 400	7, 020	4, 092
South Carolina.....	500	400	11, 000	6, 000	12, 980	6, 000
Georgia.....	600	550	12, 000	8, 800	14, 280	10, 296
Florida.....	60	55	1, 080	770	1, 242	755
Ohio.....	1, 890	1, 775	79, 200	78, 100	55, 440	49, 984
Indiana.....	2, 025	2, 022	85, 050	84, 924	56, 984	53, 592
Illinois.....	4, 508	4, 600	198, 352	239, 200	132, 896	155, 480
Michigan.....	1, 658	1, 550	66, 320	55, 800	45, 761	35, 712
Wisconsin.....	2, 364	2, 250	110, 162	99, 000	73, 809	65, 340
Minnesota.....	3, 282	3, 250	134, 562	120, 250	81, 774	75, 758
Iowa.....	5, 466	5, 412	229, 572	254, 364	146, 926	167, 249
Missouri.....	1, 524	1, 480	44, 196	59, 200	30, 937	36, 112
North Dakota.....	2, 575	2, 575	60, 512	38, 625	35, 912	23, 948
South Dakota.....	2, 160	2, 138	84, 240	72, 692	49, 702	41, 342
Nebraska.....	2, 531	3, 038	56, 188	115, 444	36, 522	70, 421
Kansas.....	2, 329	2, 284	51, 238	70, 804	37, 404	45, 315
Kentucky.....	400	310	9, 600	8, 060	8, 640	6, 126

OATS—Continued.

TABLE 33.—Oats: Acreage, production, and total farm value, by States, 1917 and 1918—Continued.

State.	Thousands of acres.		Production (thousands of bushels).		Total value, basis Dec. 1 price (thousands of dollars).	
	1918	1917	1918	1917	1918	1917
Tennessee.....	325	290	8,125	7,250	7,556	6,018
Alabama.....	428	420	8,132	7,560	8,701	7,711
Mississippi.....	280	300	5,600	5,700	5,992	5,358
Louisiana.....	80	84	2,000	1,873	1,980	1,761
Texas.....	1,510	1,425	22,197	37,050	20,421	30,381
Oklahoma.....	1,380	1,150	33,120	26,450	27,821	19,838
Arkansas.....	442	340	11,271	9,520	9,918	7,140
Montana.....	680	680	20,400	13,600	16,320	11,016
Wyoming.....	285	263	11,685	9,468	9,348	7,574
Colorado.....	293	293	9,669	11,134	7,735	8,462
New Mexico.....	45	45	1,260	1,350	1,121	1,134
Arizona.....	11	10	440	400	528	384
Utah.....	98	100	4,410	4,400	4,278	3,740
Nevada.....	14	14	532	560	628	538
Idaho.....	237	250	9,480	9,500	8,911	7,315
Washington.....	310	292	8,370	11,242	8,203	9,106
Oregon.....	361	365	9,025	9,125	8,664	6,844
California.....	175	196	5,600	6,860	5,264	5,831
United States.....	44,400	43,553	1,538,359	1,592,740	1,092,423	1,061,474

TABLE 34.—Oats: Production and distribution in the United States, 1897–1918.

[000 omitted.]

Year.	Old stock on farms Aug. 1.	Crop.			Total supplies.	Stock on farms Mar. 1 following.	Shipped out of county where grown.
		Quantity.	Weight per bushel.	Quality.			
	<i>Bushels.</i>	<i>Bushels.</i>	<i>Lbs.</i>	<i>P. ct.</i>	<i>Bushels.</i>	<i>Bushels.</i>	<i>Bushels.</i>
1897.....	71,139	698,768	28.6	87.6	769,907	271,729	204,147
1898.....	44,554	730,907	30.5	84.5	775,461	283,209	193,527
1899.....	50,837	796,178	29.7	89.5	846,715	290,937	223,014
1900.....	54,214	809,126	31.3	89.2	863,340	292,803	242,850
1901.....	47,713	736,809	31.1	83.7	784,522	226,393	143,398
1902.....	30,570	987,843	30.7	86.7	1,018,413	364,926	258,438
1903.....	73,352	784,094	31.0	79.9	857,446	273,708	223,959
1904.....	42,194	894,596	29.7	91.4	936,790	347,166	261,989
1905.....	55,836	953,216	31.5	92.4	1,009,052	379,805	277,133
1906.....	67,688	964,905	32.0	88.2	1,032,593	384,461	266,182
1907.....	68,258	754,443	29.4	77.0	822,701	267,476	210,923
1908.....	37,797	807,156	29.8	81.3	844,953	278,847	244,444
1909.....	26,323	1,007,143	32.7	91.4	1,033,466	365,438	329,255
1910.....	64,200	1,186,341	32.7	93.8	1,250,541	442,665	363,103
1911.....	67,801	922,298	31.1	84.6	990,099	289,989	265,944
1912.....	34,875	1,418,337	33.0	91.0	1,453,212	604,249	438,130
1913.....	103,916	1,121,768	32.1	89.1	1,225,684	419,481	297,365
1914.....	62,467	1,141,060	31.5	86.5	1,203,527	379,369	335,539
1915.....	55,607	1,549,030	33.0	87.5	1,604,637	598,148	465,823
1916.....	113,728	1,251,837	31.2	88.2	1,365,565	394,211	355,092
1917.....	47,834	1,592,740	33.4	95.1	1,640,574	599,208	514,117
1918.....	81,424	1,538,359	33.2	93.6	1,619,783	588,421	418,480

OATS—Continued.

TABLE 35.—Oats: Yield per acre, price per bushel Dec. 1, and value per acre, by States.

State.	Yield per acre (bushels).										Farm price per bushel (cents).					Value per acre (dollars). ¹			
	10-year average, 1909-1918.	1909	1910	1911	1912	1913	1914	1915	1916	1917	1918	10-year average, 1909-1918.	1914	1915	1916	1917	1918	5-year average, 1914-1918.	1918
	Me.....	37.8	37.0	42.4	38.5	34.6	40.0	41.0	40.0	36.0	29.0	40.0	61	57	45	67	85	90	25.23
N. H.....	37.1	31.5	42.8	33.8	39.0	35.0	38.0	38.0	37.0	38.0	38.0	63	58	54	69	84	87	26.61	33.06
Vt.....	38.5	32.2	41.5	35.0	43.0	39.0	42.5	43.0	32.0	36.0	41.0	61	55	53	65	85	90	26.89	36.90
Mass.....	35.2	31.0	35.5	35.0	34.0	35.0	37.0	36.0	32.0	37.0	40.0	61	56	51	66	81	91	25.31	36.40
R. I.....	30.4	25.0	35.0	29.0	28.6	26.0	27.5	33.0	27.0	31.0	42.0	60	58	50	68	75	90	22.37	37.80
Conn.....	32.1	27.5	36.8	35.1	30.7	28.0	29.0	32.5	30.0	33.0	38.0	60	55	55	69	79	90	22.96	34.20
N. Y.....	33.0	28.2	34.5	29.5	30.8	33.5	31.5	40.5	26.0	35.0	41.0	55	51	45	62	75	84	22.22	34.44
N. J.....	31.3	25.5	37.1	28.5	27.6	29.0	29.0	32.5	30.0	34.0	40.0	55	54	48	61	70	79	20.99	31.60
Pa.....	32.7	26.0	35.2	28.3	33.1	31.0	30.0	38.0	31.0	35.0	39.0	53	51	44	57	73	80	21.29	31.20
Del.....	30.8	25.5	33.8	30.0	30.5	27.0	33.5	30.0	32.0	35.0	56	50	51	62	78	87	20.92	30.45	
Md.....	29.5	25.4	30.0	27.0	30.0	28.0	27.0	34.0	29.5	31.0	33.0	56	52	49	61	75	86	20.07	28.38
Va.....	21.6	19.0	22.0	20.0	22.2	21.5	15.5	25.0	23.5	24.5	23.0	62	58	55	63	84	100	16.22	23.00
W. Va.....	24.7	22.0	25.2	22.0	28.0	24.0	20.0	29.0	23.0	27.0	27.0	60	55	51	64	79	91	17.28	24.57
N. C.....	18.3	16.5	18.2	16.5	18.6	19.5	17.5	23.0	17.5	16.0	20.0	71	65	62	74	93	108	15.01	21.96
S. C.....	20.1	21.0	21.0	20.4	21.5	23.5	20.0	19.0	18.0	15.0	22.0	78	71	67	80	100	118	16.46	25.60
Ga.....	19.6	19.0	18.2	21.5	20.8	22.0	20.0	19.5	19.5	16.0	20.0	79	70	66	79	117	119	16.96	23.80
Fla.....	16.7	17.0	16.2	13.5	17.2	18.0	18.0	20.0	15.0	14.0	18.0	78	70	70	71	98	115	14.33	20.70
Ohio.....	36.4	32.5	37.2	32.1	44.0	30.2	30.5	41.0	28.0	44.0	44.0	46	45	36	53	64	70	24.46	30.80
Ind.....	33.9	30.5	35.4	28.7	40.1	21.4	28.5	40.0	30.0	42.0	42.0	44	43	34	51	63	67	19.15	28.14
Ill.....	37.9	36.6	38.0	28.8	43.3	23.8	29.3	45.0	38.5	52.0	44.0	44	44	35	51	65	67	22.31	29.48
Mich.....	34.0	30.5	34.0	28.6	34.9	30.0	33.5	42.0	30.0	36.0	40.0	46	45	35	53	64	69	19.26	27.60
Wis.....	37.0	35.0	29.8	28.8	37.3	36.5	27.0	46.5	37.0	44.0	46.6	45	43	36	51	66	67	21.50	31.22
Minn.....	34.0	33.0	28.7	22.8	41.7	37.8	28.0	43.0	26.5	37.0	41.0	41	40	32	47	63	63	17.31	25.83
Iowa.....	36.8	27.0	37.8	25.5	44.2	34.5	33.0	40.0	37.0	47.0	42.0	41	41	32	48	63	64	20.12	26.88
Mo.....	27.1	27.0	33.6	14.8	33.0	21.2	21.5	26.0	25.0	40.0	29.0	47	44	38	53	61	70	15.46	20.30
N. Dak.....	25.8	32.0	7.0	23.5	41.4	25.7	28.0	40.0	21.5	15.0	23.5	39	37	27	44	62	61	10.85	14.34
S. Dak.....	29.4	30.0	23.0	7.4	43.8	26.5	27.5	42.0	30.5	34.0	39.0	40	38	28	46	61	59	16.00	23.01
Nebr.....	27.8	25.0	28.0	13.9	24.4	26.5	32.0	32.5	35.5	38.0	22.2	42	40	31	47	61	65	15.40	14.43
Kans.....	36.4	28.2	33.3	15.0	32.0	19.5	33.5	26.5	23.5	31.0	22.0	47	42	37	55	64	73	14.54	16.06
Ky.....	23.0	22.3	25.0	18.4	26.9	19.8	21.0	26.0	21.0	26.0	24.0	57	53	48	60	76	90	15.51	21.60
Tenn.....	22.4	20.0	23.0	19.5	21.7	21.0	23.0	24.5	21.0	25.0	25.0	59	53	50	62	83	93	16.29	23.25
Ala.....	19.0	16.5	18.5	19.2	20.0	20.5	22.0	19.0	17.5	18.0	19.0	74	69	63	75	102	107	15.79	20.33
Miss.....	19.2	16.0	19.2	18.4	17.4	20.0	23.0	21.5	18.0	19.0	20.0	71	65	60	74	94	107	16.09	21.40
La.....	22.0	20.0	21.5	21.0	20.8	22.0	23.0	25.0	19.0	22.3	25.0	66	63	55	68	94	99	17.37	24.75
Tex.....	27.7	18.7	35.0	25.1	36.0	32.5	25.0	35.5	28.5	26.0	14.7	58	48	42	61	82	92	15.83	13.52
Okla.....	23.2	29.0	36.5	9.0	25.1	18.0	27.5	27.0	12.5	23.0	24.0	50	41	35	57	75	84	13.05	20.16
Ark.....	24.2	22.8	27.5	20.0	19.9	26.5	24.0	27.0	21.0	28.0	25.5	60	53	52	68	75	88	16.90	22.44
Mont.....	40.6	51.3	38.0	49.8	48.0	43.5	35.0	52.0	38.0	20.0	30.0	47	39	32	47	81	80	10.67	24.00
Wyo.....	37.0	35.0	32.0	34.5	41.8	38.0	35.0	42.0	35.0	36.0	41.0	54	48	43	60	80	80	23.49	32.80
Colo.....	37.3	38.0	39.1	35.0	42.8	35.0	40.0	39.0	33.0	38.0	33.0	53	45	41	60	76	80	21.80	26.40
N. Mex.....	33.2	40.0	27.4	38.8	34.7	30.0	38.0	36.0	29.0	30.0	28.0	62	45	50	67	84	89	20.93	24.92
Ariz.....	40.3	37.0	40.1	42.0	44.7	43.0	42.0	37.0	37.5	40.0	40.0	78	70	64	80	96	120	33.90	48.00
Utah.....	45.6	46.1	43.0	44.0	46.4	46.0	50.0	47.0	43.5	44.0	45.0	57	43	45	61	85	97	30.05	43.65
Nev.....	43.1	40.0	44.7	45.0	40.0	43.0	52.0	45.0	43.0	40.0	38.0	70	55	55	75	96	118	33.77	44.84
Idaho.....	43.4	44.5	38.5	44.0	48.9	46.5	44.0	47.0	43.0	38.0	40.0	50	38	34	54	77	94	24.56	37.60
Wash.....	45.4	49.0	42.8	51.7	48.2	47.5	47.0	50.0	52.0	38.5	27.0	53	42	37	51	81	98	24.48	26.46
Oreg.....	36.4	37.8	34.5	34.7	38.2	42.3	35.0	44.0	48.0	25.0	25.0	52	45	37	49	75	96	19.66	24.00
Calif.....	34.0	31.4	37.0	34.0	39.0	31.6	35.0	33.0	32.5	35.0	32.0	64	53	50	72	85	94	23.66	30.08
U. S.....	32.2	30.3	31.6	24.4	37.4	29.2	29.7	37.8	30.1	36.6	34.6	46.1	43.8	36.1	52.4	66.6	71.0	18.28	24.60

¹ Based upon farm price Dec. 1.

OATS—Continued.

TABLE 36.—Oats: Farm price, cents per bushel on first of each month, 1909–1918.

Date.	1918	1917	1916	1915	1914	1913	1912	1911	1910	1909	Average.
Jan. 1.....	73.9	51.4	39.1	45.0	39.1	32.2	45.1	33.2	42.8	48.1	45.0
Feb. 1.....	78.7	55.2	44.6	50.1	39.3	32.4	47.5	33.1	45.0	48.1	47.4
Mar. 1.....	86.2	56.9	42.7	52.1	38.9	33.1	49.8	32.8	46.0	51.1	49.0
Apr. 1.....	88.9	61.5	42.0	53.4	39.5	33.1	52.0	32.3	45.6	53.2	50.2
May 1.....	86.0	71.0	42.6	53.4	39.5	34.2	56.0	33.2	43.3	55.3	51.4
June 1.....	78.1	69.9	42.1	51.3	40.0	36.0	55.3	34.7	43.0	57.4	50.8
July 1.....	76.3	68.9	40.4	46.7	38.8	37.7	52.5	37.5	42.1	56.2	49.7
Aug. 1.....	73.0	73.7	40.1	45.4	36.7	37.6	44.3	40.2	41.7	50.0	48.3
Sept. 1.....	70.3	61.7	43.1	38.5	42.3	39.3	35.0	40.4	38.4	42.3	45.1
Oct. 1.....	71.0	62.3	44.5	34.5	43.3	39.6	33.6	42.5	36.2	41.0	44.8
Nov. 1.....	68.2	61.7	49.0	34.9	42.9	37.9	33.6	43.8	34.9	41.0	44.8
Dec. 1.....	71.0	66.6	52.4	36.1	43.8	39.2	31.9	45.0	34.4	40.2	46.1
Average.....	74.7	62.7	44.0	42.5	40.9	36.8	41.4	38.7	39.9	46.4	46.8

TABLE 37.—Oats: Condition of crop, United States, on first of months named, 1898–1918.

Year.					Year.					Year.				
	June.	July.	August.	When har-vested.		June.	July.	August.	When har-vested.		June.	July.	August.	When har-vested.
	<i>P. ct.</i>	<i>P. ct.</i>	<i>P. ct.</i>	<i>P. ct.</i>		<i>P. ct.</i>	<i>P. ct.</i>	<i>P. ct.</i>	<i>P. ct.</i>		<i>P. ct.</i>	<i>P. ct.</i>	<i>P. ct.</i>	<i>P. ct.</i>
1898....	98.0	92.8	84.2	79.0	1905....	92.9	92.1	90.8	90.3	1912....	91.1	89.2	90.3	92.3
1899....	88.7	90.0	90.8	87.2	1906....	85.9	84.0	82.8	81.9	1913....	87.0	76.3	73.8	74.0
1900....	91.7	85.5	85.0	82.9	1907....	81.6	81.0	75.6	65.5	1914....	89.5	84.7	79.4	75.8
1901....	85.3	83.7	73.6	72.1	1908....	92.9	85.7	76.8	69.7	1915....	92.2	93.9	91.6	91.1
1902....	90.6	92.1	89.4	87.2	1909....	88.7	88.3	85.5	83.8	1916....	86.9	86.3	81.5	78.0
1903....	85.5	84.3	79.5	75.7	1910....	91.0	82.2	81.5	82.3	1917....	88.8	89.4	87.2	90.4
1904....	89.2	89.8	86.6	85.6	1911....	85.7	68.8	65.7	64.5	1918....	93.2	85.5	82.8	84.4

TABLE 38.—Oats: Wholesale price per bushel, 1913-1918.

Date.	New York, No. 2, white. ¹			Baltimore, No. 3, white.			Cincinnati, No. 2, mixed.			Chicago, contract.			Milwaukee, No. 3, white.			Duluth, No. 3, white.			Detroit, Standard.			San Francisco, white (per 100 pounds).		
	Low.	High.	Average.	Low.	High.	Average.	Low.	High.	Average.	Low.	High.	Average.	Low.	High.	Average.	Low.	High.	Average.	Low.	High.	Average.	Low.	High.	Average.
1913	<i>Cts.</i>	<i>Cts.</i>	<i>Cts.</i>	<i>Cts.</i>	<i>Cts.</i>	<i>Cts.</i>	<i>Cts.</i>	<i>Cts.</i>	<i>Cts.</i>	<i>Cts.</i>	<i>Cts.</i>	<i>Cts.</i>	<i>Cts.</i>	<i>Cts.</i>	<i>Cts.</i>	<i>Cts.</i>	<i>Cts.</i>	<i>Cts.</i>	<i>Cts.</i>	<i>Cts.</i>	<i>Dolls.</i>	<i>Dolls.</i>	<i>Dolls.</i>	
Jan.—June.....	36½	47	40.4	38½	47	41.6	33½	43½	36.4	31½	42½	35.4	31½	42½	35.4	27½	41½	33.0	34½	44½	1.43½	1.67½	1.55	
July—Dec.....	42½	48½	45.4	45	47½	46.2	39	47	42.3	36½	43½	39.7	37½	44	40.6	33½	42½	37.8	41	45½	1.37½	1.57½	1.48	
1914.																								
Jan.—June.....	43½	48½	45.9	42½	46½	45.6	39½	44	41.6	36½	42½	38.9	36½	43	39.4	33½	40	37.0	39½	45	41.6	1.22½	1.46½	1.313
July—Dec.....	43½	58½	51.3	41½	55	49.7	35	51	45.7	33½	51½	45.0	34½	52	45.2	33½	50½	43.7	37½	53	47.4	1.20	1.60	1.432
1915.																								
Jan.—June.....	53½	66½	61.2	50	64	59.0	46	61½	55.8	46½	60½	54.2	47½	61½	54.8	44½	58½	52.9	50	62	57.0	1.40	1.85	1.725
July—Dec.....	55	70½	64.2	38	66	47.1	33	58	42.0	35½	60	43.9	33½	63	42.4	31½	58	39.2	36½	65	45.8	1.30	1.50	1.393
1916.																								
Jan.—June.....	44½	57½	54.1	43	55½	48.4	38	55½	45.0	37½	51	45.0	38½	55	44.7	36½	49½	42.1	41	55½	47.4	1.32½	1.57½	1.465
July—Dec.....	44½	64	60.3	43½	61½	53.0	39	91	54.4	38½	57	47.3	38½	58½	48.1	36½	57½	45.9	42½	60½	51.3	1.50	2.07½	1.771
1917.																								
January.....	61	69½	66.9	61	70	64.5	53½	60	57.5	53½	58½	56.1	53½	58½	56.8	50½	57½	54.5	58	60½	59.8	2.00	2.02½	2.012
February.....	65	77	67.1	65	73½	67.1	57	62½	59.2	51½	56½	54.4	51½	60½	56.7	49½	56½	53.6	57	64½	60.6	1.95	2.02½	1.984
March.....	73	78	76.8	72½	76	73.9	62	70	64.8	55½	62½	58.2	57½	67	61.6	53½	62½	57.8	64½	70	66.8	1.96½	2.22½	2.048
April.....	75	79½	78.7	73½	79	76.4	68½	74½	71.9	63½	71½	66.4	67	77	70.6	61	72½	65.8	72	79	76.7	2.21½	2.95	2.575
May.....	67	79½	76.8	66½	80	75.6	65	73½	70.6	59½	74	68.7	61	76	70.8	57½	76½	67.5	66	78½	73.2	2.60	2.90	2.786
June.....	68	76	73.7	65½	75½	70.7	61½	69	66.5	62	69	66.4	62½	71½	67.5	58½	69½	64.2	65	72½	69.9	2.50	2.65	2.556
Jan.—June.....	61	79½	73.3	61	80	71.4	53½	74½	65.1	51½	74	61.7	51½	77	64.0	49½	76½	60.6	57	79	67.8	1.95	2.95	2.327
July.....	76	93½	86.0	76½	92	83.8	73	86½	77.8	68½	85	76.2	71	89½	78.3	65½	89	74.2	73	89½	81.7	2.25	2.50	2.347
August.....	67	90	77.3	62	100	87.6	56½	85½	68.7	51	80	62.0	52	82½	64.0	51½	79	61.5	56	87½	72.0	2.45	2.95	2.849
September.....	65	70	68.4	64	66½	65.5	56	62	59.6	56½	61½	59.0	57½	63½	60.4	55½	61½	58.9	58½	64	61.8	2.85	3.00	2.936
October.....	64½	68	66.4	64½	67½	64.7	64	66	60.4	59½	61	59.2	58½	60½	60.5	59½	62	57.7	55½	59½	62.2	2.50	3.00	2.723
November.....	65	80	72.4	66	77	70.4	60½	74½	64.9	58½	72½	65.1	59	75½	66.6	57½	70½	63.6	62½	77	69.0	2.70	2.75	2.718
December.....	79	92½	88.9	77	87	83.5	74	82½	77.7	70½	80½	75.7	72½	83	77.6	67½	81½	74.8	76	83½	80.1	2.70	2.75	2.725
July—Dec.....	64½	93½	76.6	62	100	75.9	56	86½	68.2	51	85	66.2	52	89½	67.9	51½	89	65.1	55½	89½	71.1	2.25	3.00	2.716

¹No. 3 white 1916-1918.

1918.

January.....	93½	102	98.3	88	101	95.6	80	88½	84.0	78½	84½	80.5	80	88½	83.4	77½	87½	81.3	82½	89½	85.1
February.....	99	106	102.4	100	105	102.5	88	99	92.1	81½	93	86.0	84	95	89.4	82½	96½	88.5	89	97	92.5
March.....	104½	109	106.9	100	107½	104.3	91	98	93.5	84½	92½	90.8	87½	96	93.4	85½	95	91.3	92	101	97.6
April.....	93½	107½	101.0	89	102	96.7	85	93	88.8	80½	90½	85.3	83½	93	89.6	82½	92½	87.9	88	95½	92.7
May.....	79	91	84.2	76½	89	81.3	70	83	74.4	72	79½	75.8	72	82½	77.0	69	81½	74.3	76	87	79.6
June.....	79	89½	84.9	77	85½	83.3	68	76	73.2	71	80½	76.8	71½	80½	77.5	69	82½	75.8	75	82	78.7
Jan.-June.....	79	109	96.3	76½	107½	94.0	68	99	84.3	71	93	82.5	71½	96	85.0	69	96½	83.2	75	101	87.7
July.....	83½	90½	88.1	83	88	86.1	75	77	76.0	72½	78½	76.1	73½	80	77.8	66½	79½	75.1	77½	83½	80.8
August.....	79	84½	81.7	76½	83	79.0	64	74	67.4	67½	72	69.8	67½	74½	70.4	65½	72½	68.8	68	77½	71.6
September.....	81	86	83.2	70	80½	77.5	68	77	73.4	70½	73½	71.8	69	75½	72.3	67½	72½	69.5	70	75½	73.1
October.....	78½	85½	82.1	76	80½	79.4	70½	73	71.8	68½	71½	68.8	65½	73	68.7	61½	68½	65.1	70	73½	72.0
November.....	81	84½	80.7	79	80½	79.7	69	74	71.1	67½	77½	73.2	65½	76	72.4	62½	73½	69.0	70	77½	73.4
December.....	78½	85	82.2	79½	81½	80.2	72½	74	73.1	68	74½	71.7	67½	75	72.0	63½	72	68.0	72	78	75.4
July-Dec.....	78½	90½	83.0	70	88	80.3	64	77	72.1	66½	78½	71.9	65½	80	72.3	61½	79½	69.2	68	83½	74.4

OATS—Continued.

TABLE 39.—Oats: International trade, calendar years 1911–13, 1916–17.

[See "General note," Table 11.]

EXPORTS.

[000 omitted.]

Country.	Average 1911–1913	1916 (prelim.)	1917 (prelim.)	Country.	Average 1911–1913	1916 (prelim.)	1917 (prelim.)
FROM—				FROM—			
	<i>Bushels.</i>	<i>Bushels.</i>	<i>Bushels.</i>		<i>Bushels.</i>	<i>Bushels.</i>	<i>Bushels.</i>
Algeria.....	1,296	Netherlands.....	33,814	17
Argentina.....	52,754	55,421	Roumania.....	10,012
Bulgaria.....	278	Russia.....	65,279	27
Canada.....	16,583	72,058	59,791	Sweden.....	2,342
China.....	412	70	229	United Kingdom...	1,411	1,271
Chile.....	2,499	United States.....	12,592	101,411	98,689
Denmark.....	151	4	Other countries...	3,727
Finland.....	433	9				
Germany.....	30,844	Total.....	234,427

IMPORTS.

INTO—				INTO—			
Austria-Hungry...	3,426	Philippine Islands.	486	165	200
Belgium.....	8,845	Russia.....	1,643	4
Denmark.....	4,126	8	Sweden.....	6,055
Cuba.....	1,361	Switzerland.....	12,484	7,320
Finland.....	1,187	18	United Kingdom...	64,755	48,986
France.....	30,746	72,324	United States.....	5,557	105,838	113,608
Germany.....	41,320	Other countries...	2,417
Italy.....	9,040	38,308	19,802				
Netherlands.....	41,901	4,902	Total.....	236,047
Norway.....	698	798	691				

BARLEY.

TABLE 40.—Barley: Area and production in undermentioned countries, 1916–1918.

Country.	Area.			Production.		
	1916	1917	1918	1916	1917	1918
NORTH AMERICA.						
United States.....	<i>Acres.</i> 7,757,000	<i>Acres.</i> 8,933,000	<i>Acres.</i> 9,679,000	<i>Bushels.</i> 182,309,000	<i>Bushels.</i> 211,759,000	<i>Bushels.</i> 256,375,000
Canada:						
New Brunswick.....	2,000	2,000	7,000	45,000	40,000
Quebec.....	73,000	166,000	189,000	1,456,000	3,064,000
Ontario.....	326,000	361,000	660,000	7,498,000	11,191,000
Manitoba.....	688,000	708,000	1,103,000	13,729,000	15,930,000
Saskatchewan.....	367,000	670,000	699,000	9,916,000	14,068,000
Alberta.....	337,000	472,000	470,000	9,774,000	10,386,000
Other.....	10,000	13,000	25,000	352,000	379,000
Total Canada.....	1,803,000	2,332,000	3,154,000	42,770,000	55,058,000	77,290,000
Mexico.....	(¹)	² 10,840,000
Total.....				235,919,000		
SOUTH AMERICA.						
Argentina.....	431,000	388,000	5,430,000	2,165,000
Chile.....	121,000	(¹)	4,358,000
Uruguay.....	10,000	13,000	115,000	110,000
Total.....	562,000	9,903,000

¹ No official statistics.² Data for 1907.

BARLEY—Continued.

TABLE 40.—Barley: Area and production in undermentioned countries, 1916–1918—Contd.

Country.	Area.			Production.		
	1916	1917	1918	1916	1917	1918
EUROPE.						
Austria-Hungary:	<i>Acres.</i>	<i>Acres.</i>	<i>Acres.</i>	<i>Bushels.</i>	<i>Bushels.</i>	<i>Bushels.</i>
Austria ¹	² 1,578,000	² 29,733,000
Hungary proper.....	² 2,830,000	² 56,186,000
Croatia-Slavonia.....	³ 158,000	² 1,938,000
Bosnia-Herzegovina.....	⁸ 263,000	² 3,000,000
Total Austria-Hungary.....	4,829,000	90,857,000
Belgium.....	⁴ 84,000	² 4,000,000
Bulgaria.....	⁴ 554,000	14,739,000
Denmark.....	633,000	592,000	594,000	24,477,000	17,881,000
Finland.....	⁵ 273,000	⁴ 4,316,000
France ⁶	1,538,000	1,789,000	1,396,000	38,268,000	39,557,000
Germany.....	² 4,002,000	² 114,077,000
Italy.....	596,000	469,000	494,000	11,041,000	7,422,000	9,186,000
Luxemburg.....	5,000	7,000	7,000	125,000	154,000	136,000
Netherlands.....	60,000	52,000	58,000	2,498,000	2,573,000	2,176,000
Norway.....	98,000	97,000	116,000	3,415,000	3,000,000
Roumania.....	1,454,000	30,038,000
Russia:
Russia proper ⁶	22,031,000	350,223,000
Poland.....	⁸ 1,283,000	⁸ 29,859,000
Northern Caucasia.....	² 4,400,000	² 75,328,000
Total Russia (European).....	27,714,000	455,410,000
Serbia.....	³ 149,000	² 2,250,000
Spain.....	3,886,000	4,088,000	4,203,000	86,863,000	76,747,000	90,496,000
Sweden.....	421,000	438,000	452,000	14,621,000	12,263,000	12,947,000
United Kingdom:
England.....	1,245,000	1,365,600	40,022,000	42,897,000
Wales.....	87,000	95,000	2,731,000	2,781,000
Scotland.....	170,000	159,000	5,340,000	5,816,000
Ireland.....	150,000	177,000	6,474,000	7,796,000
Total United Kingdom.....	1,652,000	1,796,000	54,567,000	59,290,000	65,029,000
Total.....	47,943,000	951,562,000
ASIA.						
British India.....	7,924,000	7,856,000	147,653,000	155,447,000
Cyprus.....	(⁷)	² 2,000,000
Japanese Empire:
Japan.....	3,075,000	2,888,000	2,721,000	89,336,000	88,896,000	76,052,000
Formosa.....	5,000	50,000
Korea ⁴	1,185,000	24,872,000
Total Japanese Empire.....	4,265,000	114,258,000
Russia:
Central Asia (4 governments of).....	² 350,000	² 3,278,000
Siberia (4 governments of).....	² 651,000	² 5,753,000
Transcaucasia (1 government of).....	² 2,000	² 38,000
Total.....	² 1,003,000	² 9,069,000
Total.....	13,192,000	272,980,000

¹ Galicia and Bukowina not included.

² Data for 1915.

³ Data for 1913.

⁴ Data for 1914.

⁵ Data for 1910.

⁶ Excludes territory occupied by the enemy.

⁷ No official statistics.

BARLEY—Continued.

TABLE 40.—Barley: Area and production in undermentioned countries, 1916–1918—Contd.

Country.	Area.			Production.		
	1916	1917	1918	1916	1917	1918
AFRICA.						
	<i>Acres.</i>	<i>Acres.</i>	<i>Acres.</i>	<i>Bushels.</i>	<i>Bushels.</i>	<i>Bushels.</i>
Algeria.....	3,009,000	2,839,000	2,794,000	35,969,000	28,529,000	58,422,000
Egypt.....	439,000	445,000	336,000	13,161,000	13,598,000	9,871,000
Tunis.....	1,233,000	1,038,000	1,238,000	4,914,000	8,267,000	9,186,000
Union of South Africa.....	64,000	57,000	58,000	(¹)	1,000,000
Total.....	4,745,000	54,044,000	54,394,000
AUSTRALASIA.						
Australia:						
Queensland.....	1,000	13,000	8,000	250,000
New South Wales.....	6,000	5,000	115,000	73,000
Victoria.....	61,000	93,000	1,735,000	1,800,000
South Australia.....	85,000	104,000	1,698,000	1,734,000
Western Australia.....	10,000	11,000	131,000	134,000
Tasmania.....	5,000	5,000	116,000	89,000
Total Australia.....	170,000	230,000	3,802,000	4,080,000
New Zealand.....	30,000	30,000	31,000	820,000	759,000	833,000
Total Australasia.....	200,000	260,000	4,622,000	4,839,000
Grand total.....	1,529,031,000

¹ No official statistics.

TABLE 41.—Barley: Total production of countries named in Table 40, 1895–1916.

Year.	Production.	Year.	Production.	Year.	Production.	Year.	Production.
	<i>Bushels.</i>		<i>Bushels.</i>		<i>Bushels.</i>		<i>Bushels.</i>
1895.....	915,504,000	1901.....	1,072,195,000	1907.....	1,271,237,000	1913.....	1,650,265,000
1896.....	932,100,000	1902.....	1,229,132,000	1908.....	1,274,897,000	1914.....	1,463,289,000
1897.....	864,605,000	1903.....	1,235,786,000	1909.....	1,458,263,000	1915.....	1,522,732,000
1898.....	1,030,581,000	1904.....	1,175,784,000	1910.....	1,388,734,000	1916.....	1,529,031,000
1899.....	965,720,000	1905.....	1,180,053,000	1911.....	1,373,286,000		
1900.....	959,622,000	1906.....	1,296,579,000	1912.....	1,466,977,000		

TABLE 42.—Barley: Average yield per acre in undermentioned countries, 1890–1918.

Year.	United States.	Russia (Euro-pean). ¹	Ger-many. ¹	Austria. ¹	Hungary proper. ¹	France. ²	United King-dom. ²
Average:	<i>Bushels.</i>	<i>Bushels.</i>	<i>Bushels.</i>	<i>Bushels.</i>	<i>Bushels.</i>	<i>Bushels.</i>	<i>Bushels.</i>
1890–1899.....	23.4	13.3	29.4	21.1	22.6	39.8
1900–1909.....	25.5	14.3	35.3	26.3	23.4	23.6	35.0
1910–1914.....	24.6	15.7	38.0	29.1	25.0	24.6	34.4
1906.....	28.3	13.0	35.2	26.1	26.8	20.8	36.1
1907.....	23.8	14.2	38.2	27.3	23.1	24.4	36.8
1908.....	35.1	14.2	34.9	25.2	21.3	22.6	34.9
1909.....	22.5	17.9	39.5	28.4	25.1	25.4	38.9
1910.....	22.5	16.3	34.4	24.9	19.7	23.5	34.3
1911.....	21.0	14.4	37.0	27.5	26.9	25.0	34.0
1912.....	29.7	16.2	40.7	29.7	26.9	26.1	33.1
1913.....	23.8	18.5	41.3	29.7	27.6	24.5	35.1
1914.....	25.8	12.9	36.8	33.8	24.1	24.0	35.6
1915.....	32.0	14.7	28.4	18.8	19.7	19.7	31.8
1916.....	23.6	23.8	33.0
1917.....	23.7	26.8	33.0
1918.....	26.5

¹ Bushels of 48 pounds.² Winchester bushels.

BARLEY—Continued.

TABLE 43.—Barley: Acreage, production, value, exports, etc., in the United States, 1849–1918.

NOTE.—Figures in *italics* are census returns; figures in roman are estimates of the Department of Agriculture. Estimates of acres are obtained by applying estimated percentages of increase or decrease to the published numbers of the preceding year, except that a revised base is used for applying percentage estimates whenever new census data are available.

Year.	Acreage.		Average yield per acre.	Production.		Average farm price per bushel Dec. 1.	Farm value Dec. 1.	Chicago cash price per bushel, low malting to fancy. ¹				Domestic exports, fiscal year beginning July 1.	Imports, fiscal year beginning July 1.	
	Acres.	Bush.		Bushels.	Cents.			Dollars.	December.		Following May.			
									Low.	High.	Low.			High.
1849														
1859														
1866	493,000	22.9	11,284,000	70.2	7,916,000	59	70	85	100			3,247,250		
1867	1,131,000	22.7	25,727,000	70.1	18,028,000	150	180	227	250	9,810		3,783,966		
1868	1,397,000	24.4	22,896,000	109.0	24,948,000	140	170	149	175	9,077		5,069,880		
1869	1,026,000	27.9	28,761,000	70.8	20,298,000	74	85	50	62	255,490		6,727,597		
1879			29,761,000											
1870	1,109,000	23.7	26,295,000	79.1	20,792,000	68	80	72	95	340,093		4,866,700		
1871	1,114,000	24.0	26,718,000	75.8	20,264,000	55½	64	55	71	86,891		5,565,591		
1872	1,397,000	19.2	26,846,000	68.6	18,416,000	60	70	71	85	482,410		4,244,751		
1873	1,387,000	23.1	32,044,000	86.7	27,794,000	132	158	130	155	320,399		4,891,189		
1874	1,581,000	20.6	32,552,000	86.0	27,998,000	120	129½	115	137	91,118		6,255,063		
1875	1,790,000	20.6	36,909,000	74.1	27,368,000	81	88	62½	72½	317,781		10,285,957		
1876	1,767,000	21.9	38,710,000	63.0	24,403,000	63½	68½	80	85	1,186,129		6,702,965		
1877	1,669,000	21.4	35,733,000	62.5	22,287,000	56½	64	46½	52½	3,921,501		6,764,228		
1878	1,790,000	23.6	42,246,000	57.9	24,454,000	91	100	64	73	715,536		5,720,979		
1879	1,681,000	24.0	40,283,000	58.9	23,714,000	86	92	75	80	1,128,923		7,135,258		
1879	1,998,000	22.0	43,997,000											
1880	1,843,000	24.5	45,165,000	66.6	30,091,000	100	120	95	105	185,246		9,528,616		
1881	1,968,000	20.9	41,161,000	82.3	33,863,000	101	107	100	100	205,930		2,182,722		
1882	2,272,000	21.5	48,954,000	62.9	30,768,000	79	82	80	80	433,005		10,059,687		
1883	2,379,000	21.1	50,136,000	58.7	29,420,000	62	67	65	74	724,955		8,596,122		
1884	2,609,000	23.5	61,203,000	48.7	29,779,000	53	58	65	65	629,130		9,986,507		
1885	2,729,000	21.4	58,360,000	56.3	32,868,000	62	65	58	60	252,183		10,197,115		
1886	2,653,000	22.4	59,428,000	53.6	31,841,000	51	54	57	57	1,305,300		13,355,594		
1887	2,902,000	19.6	56,812,000	51.9	29,464,000	80	80	69	77	550,884		10,831,461		
1888	2,996,000	21.3	63,884,000	59.0	37,672,000					1,440,321		11,368,414		
1889	3,221,000	24.3	78,333,000	41.6	32,614,000	58	58			1,408,311		11,332,545		
1889	3,221,000	24.3	78,333,000											
1890	3,135,000	21.4	67,168,000	62.7	42,141,000					973,062		5,078,733		
1891	3,353,000	25.9	86,839,000	62.4	45,470,000					2,800,075		3,146,328		
1892	3,400,000	23.6	80,097,000	47.5	38,026,000	65	67	65	65	3,035,267		1,970,129		
1893	3,220,000	21.7	69,869,000	41.1	28,729,000	52	54	55	60	5,219,405		791,061		
1894	3,171,000	19.4	61,400,000	44.2	27,134,000	53½	55½	51	52	1,563,754		2,116,816		
1895	3,300,000	26.4	87,073,000	33.7	29,312,000	33	40	25	36	7,680,331		837,384		
1896	2,951,000	23.6	69,695,000	32.3	22,491,000	22	37	24½	35	20,030,301		1,271,787		
1897	2,719,000	24.5	66,685,000	37.7	25,142,000	25½	42	36	53	11,237,077		124,804		
1898	2,583,000	21.6	55,792,000	41.3	23,064,000	40	50½	36	42	2,267,073		110,475		
1899	2,878,000	25.5	73,382,000	40.3	29,594,000	35	45	36	44	23,661,662		189,757		
1899	4,470,000	26.8	119,635,000											
1900	2,894,000	20.4	58,926,000	40.9	24,075,000	37	61	37	57	6,293,207		171,004		
1901	4,296,000	25.6	109,933,000	45.2	49,705,000	56	63	64	72	8,714,268		57,406		
1902	4,661,000	29.0	134,954,000	45.9	61,899,000	36	70	48	56	8,429,141		56,462		
1903	4,993,000	26.4	131,861,000	45.6	60,166,000	42	61½	38	59	10,881,627		91,708		
1904	5,146,000	27.2	139,749,000	42.0	58,652,000	32	52	40	50	10,661,655		81,020		
1905	5,096,000	26.8	136,551,000	40.5	54,993,000	37	53	42	55½	17,729,360		18,049		
1906	6,324,000	28.3	178,916,000	41.5	74,236,000	41	56	66	85	8,238,842		38,319		
1907	6,448,000	23.8	153,597,000	66.6	102,290,000	78	102	60	75	4,349,078		199,741		
1908	6,646,000	25.1	166,756,000	55.4	92,442,000	57	64½	66	75	6,580,393		2,644		
1909	7,011,000	24.3	170,284,000											
1909	7,699,000	22.5	173,344,000	54.0	93,539,000	55	72	50	68	4,311,566				
1910 ²	7,743,000	22.5	173,832,000	57.8	100,426,000	72	90	75	115	9,399,346				
1911	7,627,000	21.0	160,240,000	86.9	139,182,000	102	130	68	132	1,585,242				
1912	7,530,000	20.7	223,824,000	50.5	112,957,000	43	79	45	68	17,536,703				
1913	7,499,000	23.8	178,189,000	53.7	95,731,000	50	77	51	66	6,614,747				
1914	7,565,000	25.8	194,953,000	54.3	105,903,000	60	75	74½	82	26,754,522				
1915	7,148,000	32.0	228,851,000	51.6	118,172,000	62	77	70	83	27,473,160				
1916	7,757,000	23.5	182,309,000	88.1	160,646,000	95	125	128	165	16,381,077				
1917	8,933,000	23.7	211,759,000	113.7	240,758,000	125	163	105	176	26,408,978				
1918	9,679,000	26.5	256,375,000	91.8	235,269,000	88	105							

¹ Prices 1895 to 1908 for No. 3 grade.

² Figures adjusted to census basis.

BARLEY—Continued.

TABLE 44.—Barley: Revised acreage, production, and farm value, 1879 and 1889–1909.

[See head note of Table 4.]

Year.	Acreage.	Average yield per acre.	Production.	Average farm price per bushel Dec. 1.	Farm value Dec. 1.
	<i>Acres.</i>	<i>Bushels.</i>	<i>Bushels.</i>	<i>Cents.</i>	<i>Dollars.</i>
1879.....	1,993,000	24.4	48,721,000	59.4	28,928,000
1889.....	3,221,000	24.3	78,213,000	41.6	32,574,000
1890.....	3,406,000	21.4	73,017,000	62.6	45,719,000
1891.....	3,705,000	26.1	96,589,000	51.8	50,051,000
1892.....	3,892,000	23.6	92,037,000	46.5	42,790,000
1893.....	3,855,000	21.7	83,700,000	40.5	33,922,000
1894.....	4,005,000	19.5	78,051,000	43.5	33,924,000
1895.....	4,263,000	26.9	114,732,000	32.0	36,678,000
1896.....	4,172,000	23.8	99,394,000	30.0	29,814,000
1897.....	4,150,000	24.9	103,279,000	35.2	36,346,000
1898.....	4,237,000	23.5	99,490,000	38.9	38,701,000
1899.....	4,470,000	26.1	116,552,000	39.0	45,479,000
1900.....	4,545,000	21.1	96,041,000	40.5	38,896,000
1901.....	4,742,000	25.7	121,784,000	45.2	55,068,000
1902.....	5,126,000	29.1	149,389,000	45.5	67,944,000
1903.....	5,568,000	26.4	146,864,000	45.4	66,700,000
1904.....	5,912,000	27.4	162,105,000	41.6	67,427,000
1905.....	6,250,000	27.2	170,174,000	39.4	67,005,000
1906.....	6,730,000	28.6	192,270,000	41.6	80,069,000
1907.....	6,941,000	24.5	170,008,000	66.3	112,675,000
1908.....	7,294,000	25.3	184,857,000	55.2	102,037,000
1909.....	7,699,000	24.4	187,973,000	54.8	102,947,000

TABLE 45.—Barley: Acreage, production, and total farm value, by States, 1918.

[000 omitted.]

State.	Acreage.	Production.	Farm value Dec. 1.	State.	Acreage.	Production.	Farm value Dec. 1.
	<i>Acres.</i>	<i>Bushels.</i>	<i>Dollars.</i>		<i>Acres.</i>	<i>Bushels.</i>	<i>Dollars.</i>
Maine.....	12	300	447	Kansas.....	604	6,040	5,738
New Hampshire.....	1	32	48	Kentucky.....	7	196	274
Vermont.....	16	496	759	Tennessee.....	8	184	280
New York.....	125	3,938	4,962	Texas.....	10	170	221
Pennsylvania.....	15	420	504	Oklahoma.....	8	136	169
Maryland.....	6	186	223	Montana.....	87	1,914	1,914
Virginia.....	12	324	518	Wyoming.....	30	1,110	1,443
Ohio.....	100	3,150	2,930	Colorado.....	176	4,928	5,569
Indiana.....	45	1,665	1,732	New Mexico.....	14	392	431
Illinois.....	250	9,000	8,100	Arizona.....	30	1,020	1,326
Michigan.....	275	8,332	8,332	Utah.....	32	1,120	1,568
Wisconsin.....	711	25,383	23,352	Nevada.....	12	408	628
Minnesota.....	1,400	43,400	34,720	Idaho.....	175	4,900	6,370
Iowa.....	360	11,340	9,639	Washington.....	173	2,630	3,024
Missouri.....	10	250	288	Oregon.....	178	4,450	6,052
North Dakota.....	1,724	37,281	27,215	California.....	1,320	34,320	39,468
South Dakota.....	1,400	41,300	32,214	United States..	9,679	256,375	235,269
Nebraska.....	343	5,660	4,811				

BARLEY—Continued.

TABLE 46.—Barley: Yield per acre, price per bushel Dec. 1, and value per acre, by States.

State.	Yield per acre (bushels).																		Farm price per bushel (cents).					Value per acre (dollars). ¹	
	10-year aver- age, 1909-1918.	1909	1910	1911	1912	1913	1914	1915	1916	1917	1918	10-year aver- age, 1909-1918.	1914	1915	1916	1917	1918	5-year average, 1914-1918.	1918						
	Me.	27.0	28.5	31.0	28.0	26.2	28.0	30.0	26.5	26.0	21.0	25.0	94	81	75	104	130	149	27.15	37.25					
N. H.	27.8	25.0	26.0	24.0	28.0	28.0	32.0	30.0	28.0	25.0	32.0	98	82	79	90	175	150	33.38	48.00						
Vt.	31.6	30.0	31.0	30.5	35.0	32.0	34.5	35.0	27.5	29.0	31.0	93	75	75	100	140	153	33.53	47.43						
N. Y.	27.4	24.8	28.3	25.0	26.0	26.7	28.0	32.0	23.3	28.0	31.5	88	71	75	101	130	126	28.70	39.69						
Pa.	26.5	21.8	26.5	25.0	27.5	26.0	28.0	29.5	25.0	28.0	28.0	81	70	75	75	140	120	26.65	33.60						
Md.	29.7	32.0	31.0	23.0	27.0	29.0	33.0	34.0	32.0	25.0	31.0	78	66	70	73	130	120	27.73	37.20						
Va.	27.1	28.5	29.3	23.0	25.0	26.0	26.0	29.0	27.5	30.0	27.0	89	80	75	85	139	160	30.17	43.20						
Ohio.	28.5	25.9	28.5	27.2	31.0	24.0	25.0	31.0	27.8	33.0	31.5	72	59	54	80	118	93	24.29	39.30						
Ind.	27.9	23.5	27.0	26.5	29.5	25.0	25.0	28.0	27.0	30.5	37.0	72	67	65	75	104	104	25.08	38.48						
Ill.	31.3	28.0	30.2	28.0	31.5	26.0	29.5	34.0	32.0	37.5	36.0	74	61	57	103	121	90	29.62	32.40						
Mich.	26.0	24.7	26.0	24.0	26.0	24.8	26.0	29.5	24.5	24.4	30.3	77	65	62	91	119	100	23.37	30.30						
Wis.	29.4	28.0	25.9	25.5	29.4	25.0	27.3	35.5	30.0	32.0	35.7	77	62	56	105	124	92	28.17	32.84						
Minn.	24.6	23.6	21.0	19.0	28.2	24.0	23.0	30.5	19.0	27.0	31.0	67	53	49	87	111	80	19.69	24.80						
Iowa.	28.2	22.0	29.5	21.9	31.0	25.0	26.0	31.0	29.5	35.0	31.5	70	55	49	91	117	85	24.81	26.78						
Mo.	23.8	25.0	27.0	20.0	24.8	22.0	24.0	25.0	20.0	25.0	25.0	76	65	63	93	94	115	20.44	28.75						
N. Dak.	19.7	21.0	5.5	19.5	29.9	20.0	19.5	32.0	15.5	12.5	21.5	60	45	44	80	100	73	12.69	15.70						
S. Dak.	22.1	119.5	18.2	5.4	26.0	17.5	23.0	32.0	22.7	27.0	29.5	64	50	46	83	110	78	19.55	23.01						
Nebr.	21.5	22.0	18.5	11.0	22.0	16.0	23.5	31.0	28.0	26.5	16.5	59	47	42	75	98	85	17.06	14.02						
Kans.	16.4	18.0	18.0	6.5	23.5	8.1	24.5	31.0	16.0	8.0	10.0	63	47	42	77	115	95	11.11	9.50						
Ky.	27.0	24.0	24.0	28.7	26.0	26.6	28.5	30.0	26.0	28.0	28.0	87	77	77	90	115	140	27.98	39.20						
Tenn.	23.9	24.0	23.0	28.0	26.0	25.0	27.0	24.0	23.7	15.0	23.0	95	82	75	100	144	152	24.08	34.96						
Tex.	22.8	19.4	30.0	18.0	29.3	32.0	26.0	28.0	17.0	20.0	17.0	93	70	68	80	137	130	19.93	22.10						
Okla.	19.1	23.0	30.0	10.0	20.0	9.0	25.0	26.5	12.5	18.0	17.0	78	53	50	100	148	124	17.34	21.08						
Mont.	29.8	38.0	28.0	34.5	36.5	31.0	33.0	34.0	28.0	15.0	22.0	67	53	48	76	103	100	18.24	22.00						
Wyo.	33.4	31.0	30.0	34.0	30.0	30.5	33.0	36.0	33.0	36.0	37.0	80	64	55	87	130	130	32.91	48.10						
Colo.	33.6	36.0	32.0	29.0	39.0	32.5	38.5	36.0	32.0	33.0	28.0	70	55	48	82	104	113	26.13	31.64						
N. Mex.	30.8	40.0	25.0	33.0	35.0	44.0	34.0	33.0	28.0	28.0	28.0	89	75	70	100	139	110	29.36	30.80						
Ariz.	36.9	40.0	36.0	36.5	40.0	29.0	36.0	37.0	35.0	35.0	34.0	93	60	56	108	150	130	35.66	44.20						
Utah	39.8	40.0	36.0	43.0	45.0	38.5	45.0	42.5	36.0	37.0	35.0	74	50	52	76	120	140	33.07	49.00						
Nev.	40.5	38.0	40.0	40.0	41.0	41.0	47.0	48.0	41.0	35.0	34.0	91	65	70	95	119	154	39.42	52.36						
Idaho.	37.5	40.0	33.0	42.0	43.5	42.0	38.0	40.5	39.0	29.0	28.0	70	50	52	82	105	130	27.78	36.40						
Wash.	35.5	39.5	29.0	37.0	43.0	40.0	45.0	39.0	41.5	32.0	15.2	72	52	56	84	115	115	25.81	17.48						
Oreg.	32.6	31.5	31.5	34.0	36.0	35.0	30.0	36.0	33.5	29.0	25.0	76	61	62	80	115	136	27.75	34.00						
Calif.	28.4	26.5	31.0	28.0	30.0	26.0	30.0	29.0	28.0	29.0	26.0	80	59	62	95	120	115	25.40	29.90						
U. S.	25.3	24.3	22.5	21.0	29.7	23.8	25.8	32.0	23.5	23.7	26.5	70.4	54.3	51.6	88.1	113.7	91.8	20.50	24.31						

¹ Based upon farm price Dec. 1.

TABLE 47.—Barley: Condition of crop, United States, on first of months named, 1897-1918.

Year.	Year.				Year.	Year.			
	June.	July.	August.	When harvested.		June.	July.	August.	When harvested.
	<i>P. ct.</i>	<i>P. ct.</i>	<i>P. ct.</i>	<i>P. ct.</i>		<i>P. ct.</i>	<i>P. ct.</i>	<i>P. ct.</i>	<i>P. ct.</i>
1897	87.4	88.5	87.5	86.4	1908	89.7	86.2	83.1	81.2
1898	78.8	85.7	79.3	79.2	1909	90.6	90.2	85.4	80.5
1899	91.4	92.0	93.6	86.7	1910	89.6	73.7	70.0	69.8
1900	86.2	76.3	71.6	70.7	1911	90.2	72.1	66.2	65.5
1901	91.0	91.3	86.9	83.8	1912	91.1	88.3	89.1	88.9
1902	93.6	93.7	90.2	89.7	1913	87.1	76.6	74.9	73.4
1903	91.5	86.8	83.4	82.1	1914	95.5	92.6	85.3	82.4
1904	90.5	88.5	88.1	87.4	1915	94.6	94.1	93.8	94.2
1905	93.7	91.5	89.5	87.8	1916	86.3	87.9	80.0	76.6
1906	93.5	92.5	90.3	89.4	1917	89.3	85.4	77.9	76.3
1907	84.9	84.4	84.5	78.5	1918	90.5	84.7	82.0	81.5

BARLEY—Continued.

TABLE 48.—Barley: Farm price, cents per bushel on first of each month, 1909–1918.

	1918	1917	1916	1915	1914	1913	1912	1911	1910	1909	Average.
Jan. 1.....	126.5	87.1	54.9	54.3	52.2	49.9	86.4	59.8	57.6	56.5	68.5
Feb. 1.....	131.9	92.7	61.7	62.9	52.4	51.4	91.2	64.1	59.3	58.3	72.6
Mar. 1.....	161.1	96.9	59.6	67.7	51.1	49.0	91.0	63.0	60.2	59.4	75.9
Apr. 1.....	170.2	102.3	57.2	64.7	51.7	48.5	92.3	69.1	59.7	61.2	77.7
May 1.....	158.5	120.1	59.6	63.8	49.3	48.3	96.2	74.0	56.5	63.8	79.0
June 1.....	135.4	119.3	59.6	62.0	49.1	52.7	91.1	73.8	55.7	67.0	76.6
July 1.....	113.6	106.6	59.3	55.8	47.5	83.7	81.9	70.1	53.9	67.0	70.9
Aug. 1.....	110.0	114.5	59.3	56.7	45.1	50.8	66.8	69.3	54.7	61.2	68.8
Sept. 1.....	100.9	110.0	72.9	51.9	52.5	55.2	53.5	77.0	57.2	54.6	68.6
Oct. 1.....	95.5	113.9	76.5	46.8	51.8	56.8	54.8	81.7	56.1	53.4	59.7
Nov. 1.....	94.9	111.3	83.2	50.1	51.7	54.7	53.8	84.9	55.3	53.3	69.3
Dec. 1.....	91.8	113.7	88.1	51.6	54.3	53.7	50.5	86.9	57.8	54.0	70.2
Average.....	112.5	107.7	71.0	54.1	51.5	53.3	66.9	75.2	56.9	56.5	70.6

TABLE 49.—Barley: Wholesale price per bushel, 1913–1918.

Date.	Cincinnati.			Chicago.			Milwaukee.			Minneapolis.			San Francisco.		
	Spring malt.			Low malting to fancy.			No. 3.			All grades.			Feed (per 100 lbs.).		
	Low.	High.	Average.	Low.	High.	Average.	Low.	High.	Average.	Low.	High.	Average.	Low.	High.	Average.
1913.	Cts.	Cts.	Cts.	Cts.	Cts.	Cts.	Cts.	Cts.	Cts.	Cts.	Cts.	Cts.	Cts.	Cts.	Cts.
Jan.–June.....	70	86	79.1	42	71	57.0	53	73	61.8	39	63	50.9	128	150	137.0
July–Dec.....	87	92	89.5	43	85	66.2	58	60	68.4	42	73	56.9	123½	142½	132.0
1914.															
Jan.–June.....	60	70	64.5	49	79	60.6	53	68	61.0	41	65	51.1	90	132½	109.2
July–Dec.....	70	80	75.3	50	82	65.6	51½	82	67.9	40	76	56.6	95	130	110.0
1915.															
Jan.–June.....	72	102	83.9	66	91	78.1	70½	93	78.9	58	86	70.7	100	162½	131.6
July–Dec.....	70	102	83.0	51	85	65.6	54	81	66.9	42	78	58.9	100	132½	121.7
1916.															
Jan.–June.....	83	102	93.8	64	86	74.6	68	82	75.7	59	76½	67.4	127½	136½	131.7
July–Dec.....	93	145	124.2	68	128	99.4	70	128	106.3	57	112	82.4	127½	225	178.3
1917.															
January.....	135	155	147.5	102	134	120.2	120½	129	125.7	85	122	101.2	215	227½	219.9
February.....	140	155	148.8	108	130	118.6	122	129	122.7	85	117	101.6	215	227½	223.0
March.....	140	162	151.1	108	136	123.0	127	137	131.1	92	129	109.8	215	227½	219.0
April.....	153	170	163.4	116	162	137.1	138	162½	150.9	102	155	128.6	225	305	266.7
May.....	167	182	178.0	128	165	148.4	153	166	158.9	99	155	123.5	230	240	273.7
June.....	153	170	179.2	116	162	135.4	138	162½	146.1	102	155	117.6	225	305	215.6
Jan.–June.....	135	182	161.3	102	165	130.4	120½	166	139.2	85	155	114.6	215	305	236.3
July.....	175	182	178.1	120	160	141.6	152	162	156.2	95	160	133.2	205	230	210.8
August.....	175	185	178.5	112	150	131.8	120	152	133.7	93	150	120.2	227½	257½	255.6
September.....	158	171	169.5	116	146	133.3	124	144	137.5	98	149	123.4	230	250	229.4
October.....	153	171	164.6	120	144	139.9	127	141½	133.7	98	138	119.5	240	250	244.6
November.....	147	160	154.3	115	141	126.8	123	140	133.7	95	137	158.5	240	252½	245.5
December.....	150	176	164.8	125	163	144.0	136	160	142.0	111	160	138.0	250	285	261.9
July–Dec.....	147	185	168.3	112	163	136.2	120	162	139.5	88	160	132.1	205	285	241.3
1918.															
January.....	172	176	174.0	142	175	152.0	155	168	159.1	127	175	146.8	280	295	286.0
February.....	177	216	197.0	160	218	185.2	173	220	189.5	150	216	175.9	292½	350	323.1
March.....	218	256	241.8	165	243	204.0	190	239	217.4	137	237	195.8	320	350	337.5
April.....	205	237	221.8	150	195	171.6	176	193	185.4	140	198	165.3
May.....	195	221	206.2	105	176	144.9	130	165	146.9	95	177	132.4
June.....	189	199	194.0	100	150	120.0	115	144	128.8	85	140	109.7
Jan.–June.....	172	256	205.8	100	243	163.0	115	239	171.2	85	237	154.3	280	350	315.5
July.....	180	188	184.4	100	128	112.2	114	125	120.2	90	130	103.8
August.....	180	208	196.4	90	115	100.7	97	115	105.0	82	110	95.8
September.....	204	208	206.0	90	108	99.5	100	112	102.7	83	106	91.5
October.....	108	120	112.2	80	105	94.5	95	103½	100.7	80	95	85.5	210	217½	213.8
November.....	108	112	110.0	80	109	96.6	93	108	103.4	84	100	92.1	210	217½	217.5
December.....	108	112	110.0	88	105	96.1	101	107	102.9	83	96	89.6	210	222½	215.7
July–Dec.....	108	208	153.2	80	128	99.9	93	125	105.8	80	130	94.4	210	222½	215.7

BARLEY—Continued.

TABLE 50.—Barley and malt: International trade, calendar years 1911-13, 1916-17.

[See "General note," Table 11.]

EXPORTS.

[000 omitted.]

Country.	Barley.			Malt.			Barley and malt in terms of barley.		
	Average 1911-1913	1916 (prelim.)	1917 (prelim.)	Average 1911-1913	1916 (prelim.)	1917 (prelim.)	Average 1911-1913	1916 (prelim.)	1917 (prelim.)
FROM—	<i>Bushels.</i>	<i>Bushels.</i>	<i>Bushels.</i>	<i>Bushels.</i>	<i>Bushels.</i>	<i>Bushels.</i>	<i>Bushels.</i>	<i>Bushels.</i>	<i>Bushels.</i>
Algeria.....	4,720						4,720		
Argentina.....	917	3,104					917	3,104	
Austria-Hungary...	7,529			11,816			18,271		
Belgium.....	3,629			246			3,553		
British India.....	17,129						17,129		
Bulgaria.....	1,700						1,700		
Canada.....	6,656	9,906	7,034	15	81	202	6,670	9,980	7,218
Chile.....	608			25			631		
China.....	660	45					660	45	
Denmark.....	3,473	4		97			3,561	4	
France.....	609	135		33	545		639	630	
Germany.....	139			1,194			1,225		
Netherlands.....	28,995			678			29,611		
Roumania.....	16,690			3			16,692		
Russia.....	168,289	123		189	401		168,461	488	
United Kingdom.....	107	6		908	1,745		932	1,593	
United States.....	8,177	22,486	17,859	244	5,133	4,157	8,400	27,152	21,638
Other countries.....	15,560			10			15,569		
Total.....	285,587			15,458			299,641		

IMPORTS.

INTO—									
Argentina.....	3	1		1,437	1,085		1,310	988	
Austria-Hungary.....	838			1			839		
Belgium.....	19,546			759			20,236		
Brazil.....	1	2		1,074	718		978	655	
British South Africa.....	2			383	287	150	351	261	137
Canada.....	33	2	3	147	8	1,144	166	10	1,147
Cuba.....	278						278		
Denmark.....	2,041	1,096		62			2,098	1,096	
Egypt.....	690	70		218	169		889	224	
France.....	6,993	10,200		178	227		7,155	10,406	
Finland.....	311	199		237	404		526	566	
Germany.....	150,706			3,122			153,544		
Italy.....	815	38	1,229		522	331	815	513	1,530
Netherlands.....	37,646	5,846		3,893			41,184	5,846	
Norway.....	4,218	2,291	2,115	126	192	154	4,333	2,465	2,255
Russia.....	940	1		37			974	1	
Switzerland.....	1,143	1,172		3,626	1,207		4,440	2,268	
United Kingdom.....	51,636	36,909		100	54		51,727	36,957	
Other countries.....	1,751			556			2,253		
Total.....	279,591			15,956			294,036		

RYE.

TABLE 51.—*Rye: Area and production in undermentioned countries, 1916–1918.*

Country.	Area.			Production.		
	1916	1917	1918	1916	1917	1918
NORTH AMERICA.						
United States.....	Acres. 3, 213, 000	Acres. 4, 317, 000	Acres. 6, 185, 000	Bushels. 48, 862, 000	Bushels. 62, 933, 000	Bushels. 89, 103, 000
Canada:						
Quebec.....	8, 000	22, 000	29, 000	118, 000	376, 000	545, 000
Ontario.....	69, 000	68, 000	113, 000	1, 208, 000	1, 207, 000	2, 142, 000
Manitoba.....	30, 000	37, 000	240, 000	557, 000	638, 000	5, 110, 000
Saskatchewan.....	23, 000	53, 000	124, 000	548, 000	998, 000	1, 667, 000
Alberta.....	13, 000	31, 000	48, 000	440, 000	633, 000	874, 000
Other.....	(¹)	1, 000	1, 000	5, 000	5, 000	38, 000
Total Canada.....	148, 000	212, 000	555, 000	2, 876, 000	3, 857, 000	10, 376, 000
Mexico.....	(²)	(²)	³ 65, 000
Total.....	51, 803, 000
SOUTH AMERICA.						
Argentina.....	212, 000	180, 000	2, 008, 000	858, 000
Chile.....	11, 000	187, 000
Uruguay.....	(¹)	(¹)	1, 000	1, 000
Total.....	2, 195, 000
EUROPE.						
Austria-Hungary:						
Austria.....	⁵ 3, 120, 000	⁵ 51, 211, 000	(²)
Hungary.....	⁵ 2, 625, 000	⁵ 45, 975, 000	(²)
Croatia-Slavonia.....	⁶ 167, 000	⁶ 600, 000	(²)
Bosnia-Herzegovina.....	⁶ 65, 000	⁵ 2, 500, 000	(²)
Total Austria-Hungary.....	5, 977, 000	100, 286, 000
Belgium.....	⁷ 645, 000	⁶ 18, 000, 000
Bulgaria.....	⁷ 527, 000	8, 490, 000
Denmark.....	481, 000	436, 000	537, 000	10, 801, 000	8, 858, 000	12, 716, 000
Finland.....	⁸ 592, 000	⁷ 11, 291, 000
France.....	2, 149, 000	2, 002, 000	1, 942, 000	33, 351, 000	27, 509, 000
Germany.....
Italy.....	290, 000	279, 000	272, 000	5, 582, 000	4, 460, 000	4, 724, 000
Luxemburg.....	23, 000	17, 000	17, 000	² 66, 000	292, 000	422, 000
Netherlands.....	499, 000	463, 000	441, 000	12, 321, 000	11, 958, 000	10, 207, 000
Norway.....	48, 000	48, 000	37, 000	913, 000	656, 000
Roumania.....	200, 000	(²)
Russia:						
Russia proper.....	55, 637, 000	843, 740, 000
Poland.....
Northern Caucasia.....
Total.....
Serbia.....
Spain.....	1, 846, 000	1, 800, 000	1, 818, 000	28, 782, 000	24, 365, 000	30, 445, 000
Sweden.....	913, 000	813, 000	936, 000	22, 929, 000	15, 747, 000	25, 648, 000
Switzerland.....	71, 000	55, 000	72, 000	2, 000, 000	1, 752, 000	1, 850, 000
United Kingdom.....	60, 000	64, 000	116, 000	(²)	(²)	(²)
Total.....
AUSTRALASIA.						
Australia:						
Queensland.....	(¹)	(¹)	1, 000	2, 000
New South Wales.....	3, 000	2, 000	32, 000	31, 000
Victoria.....	3, 000	3, 000	43, 000	43, 000
South Australia.....	3, 000	2, 000	31, 000	11, 000
Western Australia.....	1, 000	1, 000	4, 000	4, 000
Tasmania.....	1, 000	1, 000	17, 000	7, 000
Total Australia.....	11, 000	9, 000	127, 000	97, 000
Grand total.....

¹ Less than 500 acres.² No official estimates.³ Data for 1907.⁴ Galicia and Bukowina not included.⁵ Data for 1915.⁶ Data for 1913.⁷ Data for 1914.⁸ Census of 1910.⁹ Excludes territory occupied by the enemy.

RYE—Continued.

TABLE 52.—Rye: Total production of countries named in Table 51, 1895–1915.

Year.	Production.	Year.	Production.	Year.	Production.	Year.	Production.
	<i>Bushels.</i>		<i>Bushels.</i>		<i>Bushels.</i>		<i>Bushels.</i>
1895....	1,468,212,000	1901.....	1,416,022,000	1907.....	1,538,778,000	1913.....	1,880,387,000
1896....	1,499,250,000	1902.....	1,647,845,000	1908.....	1,590,057,000	1914.....	1,596,882,000
1897....	1,300,645,000	1903.....	1,659,961,000	1909.....	1,747,123,000	1915.....	1,577,490,000
1898....	1,461,171,000	1904.....	1,742,112,000	1910.....	1,673,473,000		
1899....	1,583,179,000	1905.....	1,495,751,000	1911.....	1,753,933,000		
1900....	1,557,634,000	1906.....	1,433,395,000	1912.....	1,886,517,000		

TABLE 53.—Rye: Average yield per acre in undermentioned countries, 1890–1918.

Year.	United States.	Russia (European). ¹	Germany. ¹	Austria. ¹	Hungary proper. ¹	France. ²	Ireland. ¹
Average:	<i>Bushels.</i>	<i>Bushels.</i>	<i>Bushels.</i>	<i>Bushels.</i>	<i>Bushels.</i>	<i>Bushels.</i>	<i>Bushels.</i>
1890–1899.....	13.9	10.4	20.9	16.1	17.6	17.6	25.2
1900–1909.....	15.7	11.5	25.6	19.0	17.6	17.1	27.5
1910–1914.....	16.3	12.5	28.3	22.2	18.5	16.1	29.9
1906.....	16.7	8.8	25.1	19.9	19.8	16.3	27.6
1907.....	16.4	10.8	25.8	18.9	16.0	18.2	27.0
1908.....	16.4	11.0	28.0	22.0	17.5	16.8	29.2
1909.....	13.4	12.6	28.8	22.3	17.8	18.1	30.8
1910.....	16.0	12.3	27.1	21.3	18.9	14.7	30.3
1911.....	15.6	10.5	28.2	20.9	18.7	15.8	29.0
1912.....	16.8	14.3	29.5	23.3	19.4	16.5	30.6
1913.....	16.2	13.5	30.4	22.0	19.6	17.0	30.0
1914.....	16.8	12.1	26.4	23.7	16.1	16.6	29.4
1915.....	17.3	14.6	22.8	16.4	17.5	14.3	29.2
1916.....	15.3					15.4	29.0
1917.....	14.6					13.7	29.2
1918.....	14.4						

¹ Bushels of 56 pounds.

² Winchester bushels.

TABLE 54.—Rye: Acreage, production, value, exports, etc., in the United States, 1849–1918.

NOTE.—Figures in *italics* are census returns; figures in *roman* are estimates of the Department of Agriculture. Estimates of acres are obtained by applying estimated percentages of increases or decrease to the published numbers of the preceding year, except that a revised base is used for applying percentage estimates whenever new census data are available.

Year.	Acreage harvested.	Average yield per acre.	Production.	Average farm price per bushel Dec. 1.	Farm value Dec. 1.	Chicago cash price per bushel, No. 2.				Domestic exports, including rye flour, fiscal year beginning July 1..
						December.		Following May.		
						Low.	High.	Low.	High.	
1849.....			14,189,000							
1859.....			21,101,000							
1866.....	1,548,000	13.5	20,865,000	82.2	17,150,000			142	150	234,971
1867.....	1,689,000	13.7	23,184,000	100.4	23,281,000	132	157	173	185	564,901
1868.....	1,651,000	13.6	22,505,000	94.9	21,349,000	106½	118	100	115½	92,869
1869.....	1,658,000	13.6	22,528,000	77.0	17,342,000	66	77½	78	83½	199,450
1869.....			16,919,000							
1870.....	1,176,000	13.2	15,474,000	73.2	11,327,000	67	74	81	91	87,174
1871.....	1,070,000	14.4	15,366,000	71.1	10,928,000	62	63½	75	93	832,689
1872.....	1,049,000	14.2	14,889,000	67.6	10,071,000	57½	70	68½	70	611,749
1873.....	1,150,000	13.2	15,142,000	70.3	10,638,000	70	81	91	102	1,923,404
1874.....	1,117,000	13.4	14,991,000	77.4	11,610,000	93	99½	103	107½	267,058
1875.....	1,360,000	13.0	17,722,000	67.1	11,894,000	67	68½	61½	70½	589,159
1876.....	1,468,000	13.9	20,375,000	61.4	12,505,000	65½	73	70	92½	2,234,856
1877.....	1,413,000	15.0	21,170,000	57.6	12,202,000	55½	56½	54	60	4,249,684
1878.....	1,623,000	15.9	25,843,000	52.5	13,566,000	44	44½	47	52	4,877,821
1879.....	1,625,000	14.5	23,639,000	65.6	15,507,000	73½	81	73½	85	2,943,894
1879.....	1,842,000	10.8	19,832,000							
1880.....	1,768,000	13.9	24,541,000	75.6	18,565,000	82	91½	115	118	1,955,155
1881.....	1,789,000	11.6	20,705,000	93.3	19,327,000	96½	98	77	83	1,003,609
1882.....	2,228,000	13.4	29,960,000	61.5	18,439,000	57	58½	62	67	2,206,212
1883.....	2,315,000	12.1	28,059,000	58.1	16,301,000	56½	60	60½	62½	6,247,590
1884.....	2,344,000	12.2	28,640,000	51.9	14,857,000	51	52	68	73	2,974,390

RYE—Continued.

TABLE 54.—*Rye: Acreage, production, value, exports, etc., in the United States, 1849–1918—Continued.*

Year.	Acreage harvested.	Average yield per acre.	Production.	Average farm price per bushel Dec. 1.	Farm value Dec. 1.	Chicago cash price per bushel, No. 2.				Domestic exports, including rye flour, fiscal year beginning July 1.
						December.		Following May.		
						Low.	High.	Low.	High.	
	<i>Acres.</i>	<i>Bush.</i>	<i>Bushels.</i>	<i>Cents.</i>	<i>Dollars.</i>	<i>Cts.</i>	<i>Cts.</i>	<i>Cts.</i>	<i>Cts.</i>	<i>Bushels.</i>
1885.....	2,129,000	10.2	21,756,000	57.9	12,558,000	58½	61	58	61	216,699
1886.....	2,130,000	11.5	24,489,000	53.8	13,181,000	53½	54½	54½	56½	377,302
1887.....	2,053,000	10.1	20,693,000	54.5	11,283,000	55½	61½	63	68	94,827
1888.....	2,365,000	12.0	28,415,000	58.8	16,722,000	50	52	39	41½	309,266
1889.....	2,171,000	13.1	28,420,000	42.3	12,010,000	44	45½	49½	54	2,280,975
1889.....	2,172,000	13.1	28,421,000							
1890.....	2,142,000	12.0	25,807,000	62.9	16,230,000	64½	68½	83	92	358,263
1891.....	2,176,000	14.6	31,752,000	77.4	24,589,000	86	92	70½	79	12,068,628
1892.....	2,164,000	12.9	27,979,000	54.2	15,160,000	46	51	50½	62	1,493,924
1893.....	2,038,000	13.0	26,555,000	51.3	13,612,000	45	47½	44½	48	249,152
1894.....	1,945,000	13.7	26,728,000	50.1	13,395,000	47½	49	62½	67	32,045
1895.....	1,890,000	14.4	27,210,000	44.0	11,965,000	32	35½	33	36½	1,011,128
1896.....	1,831,000	13.3	24,369,000	40.9	9,961,000	37	42½	32½	35½	8,575,663
1897.....	1,704,000	16.1	27,363,000	44.7	12,240,000	45½	47	48	75	15,562,035
1898.....	1,643,000	15.6	25,658,000	46.3	11,875,000	52½	55½	56½	62	10,169,822
1899.....	1,659,000	14.4	23,962,000	51.0	12,214,000	49	52	53	56½	2,382,012
1899.....	2,054,000	12.4	25,569,000							
1900.....	1,591,000	15.1	23,996,000	51.2	12,295,000	45½	49½	51½	54	2,345,512
1901.....	1,988,000	15.3	30,345,000	55.7	16,910,000	59	65½	54½	58	2,712,077
1902.....	1,979,000	17.0	33,631,000	50.8	17,081,000	48	49½	48	50½	5,445,273
1903.....	1,907,000	15.4	29,363,000	54.5	15,994,000	50½	52½	69½	78	784,068
1904.....	1,793,000	15.2	27,242,000	68.8	18,748,000	73	75	70	84	29,749
1905.....	1,730,000	16.5	28,486,000	61.1	17,414,000	64	68	58	62	1,387,826
1906.....	2,002,000	16.7	33,375,000	58.9	19,671,000	61	65	69	87½	769,717
1907.....	1,926,000	16.4	31,566,000	73.1	23,068,000	75	82	79	86	2,444,588
1908.....	1,948,000	16.4	31,851,000	73.6	23,455,000	75	77½	83	90	1,295,701
1909.....	2,006,000	16.1	32,239,000							
1909.....	2,196,000	13.4	29,520,000	71.8	21,163,000	72	80	74	80	242,262
1910 ¹	2,185,000	16.0	34,897,000	71.5	24,953,000	80	82	90	113	40,123
1911.....	2,127,000	15.6	33,119,000	83.2	27,557,000	91	94	90	95½	31,384
1912.....	2,117,000	16.8	35,664,000	66.3	23,636,000	58	64	60	64	1,854,738
1913.....	2,557,000	16.2	41,381,000	63.4	26,220,000	61	65	62	67	2,272,492
1914.....	2,541,000	16.8	42,779,000	86.5	37,018,000	107½	112½	115	122	13,026,778
1915.....	3,129,000	17.3	54,050,000	83.4	45,083,000	94½	98½	96½	99½	15,250,151
1916.....	3,213,000	15.2	48,862,000	122.1	59,676,000	130	151	200	240	13,703,499
1917.....	4,317,000	14.6	62,933,000	166.0	104,447,000	176	184	180	260	17,130,226
1918.....	6,185,000	14.4	89,103,000	151.5	134,947,000	154	164			

¹ Figures adjusted to census basis.TABLE 55.—*Rye: Revised acreage, production, and farm value, 1879 and 1889–1909.*

[See head note of Table 4.]

Year.	Acreage.	Average yield per acre.	Production.	Average farm price per bushel Dec. 1.		Farm value Dec. 1.
				<i>Cents.</i>	<i>Dollars.</i>	
1879.....	1,842,000	13.7	25,201,000	67.6		17,040,000
1889.....	2,172,000	13.1	28,378,000	42.3		11,991,000
1890.....	2,184,000	12.1	26,414,000	62.6		16,536,000
1891.....	2,234,000	14.7	32,761,000	77.1		25,264,000
1892.....	2,251,000	13.0	29,253,000	53.6		15,674,000
1893.....	2,178,000	13.1	28,592,000	50.2		14,360,000
1894.....	2,164,000	13.7	29,613,000	49.4		14,622,000
1895.....	2,153,000	14.5	31,139,000	42.2		13,151,000
1896.....	2,126,000	13.6	28,913,000	38.8		11,231,000
1897.....	2,077,000	16.1	33,433,000	43.2		14,454,000
1898.....	2,071,000	15.9	32,888,000	44.5		14,640,000
1899.....	2,054,000	14.8	30,334,000	49.6		15,046,000
1900.....	2,042,000	15.1	30,791,000	49.8		15,341,000
1901.....	2,033,000	15.3	31,103,000	55.4		17,220,000
1902.....	2,051,000	17.2	35,255,000	50.5		17,798,000
1903.....	2,074,000	15.4	31,990,000	54.0		17,272,000
1904.....	2,085,000	15.3	31,805,000	68.9		21,923,000
1905.....	2,141,000	16.4	35,167,000	60.4		21,241,000
1906.....	2,186,000	16.7	36,559,000	58.5		21,381,000
1907.....	2,167,000	16.4	35,455,000	72.5		25,709,000
1908.....	2,175,000	16.4	35,768,000	72.8		26,023,000
1909.....	2,196,000	16.1	35,406,000	72.2		25,548,000

RYE—Continued.

TABLE 56.—Rye: Acreage (sown and harvested) production, and total farm value, by States, 1918.

[000 omitted.]

State.	Acreage.		Production.	Farm value Dec. 1.
	Sown in fall of 1917.	Harvested.		
	<i>Acres.</i>	<i>Acres.</i>	<i>Bushels.</i>	<i>Dollars.</i>
Vermont.....	1	1	21	35
Massachusetts.....	4	4	80	182
Connecticut.....	12	11	242	496
New York.....	140	112	1,848	3,179
New Jersey.....	75	73	1,350	2,336
Pennsylvania.....	265	250	4,250	7,012
Delaware.....	1	1	14	24
Maryland.....	31	30	450	765
Virginia.....	105	100	1,200	2,100
West Virginia.....	24	22	301	542
North Carolina.....	65	60	480	950
South Carolina.....	20	18	202	596
Georgia.....	21	20	176	370
Ohio.....	120	111	1,887	2,830
Indiana.....	415	410	6,765	10,283
Illinois.....	210	200	3,800	5,700
Michigan.....	480	472	6,750	10,125
Wisconsin.....	475	436	7,674	11,511
Minnesota.....	452	435	8,700	13,050
Iowa.....	63	54	1,026	1,508
Missouri.....	38	34	476	776
North Dakota.....	2,200	1,945	20,422	29,612
South Dakota.....	600	575	10,350	14,594
Nebraska.....	400	388	5,005	6,757
Kansas.....	175	170	2,431	4,133
Kentucky.....	65	65	884	1,423
Tennessee.....	30	30	300	576
Alabama.....	4	4	44	115
Texas.....	4	4	22	52
Oklahoma.....	10	8	88	165
Arkansas.....	2	2	21	44
Montana.....	25	20	240	346
Wyoming.....	30	25	450	684
Colorado.....	78	27	324	454
Utah.....	16	16	208	374
Idaho.....	4	4	60	99
Washington.....	7	7	70	140
Oregon.....	41	41	492	1,009
United States.....	6,708	6,185	89,103	134,947

TABLE 57.—Rye: Acreage sown and harvested, United States, 1906–1918.

Year.	Acreage sown in preceding fall.	Acreage harvested.	Year.	Acreage sown in preceding fall.	Acreage harvested.
	<i>Acres.</i>	<i>Acres.</i>		<i>Acres.</i>	<i>Acres.</i>
1906.....	2,100,000	2,002,000	1913.....	2,731,000	2,557,000
1907.....	2,061,000	1,926,000	1914.....	2,773,000	2,541,000
1908.....	2,015,000	1,948,000	1915.....	3,153,000	3,129,000
1909.....	2,326,000	2,196,000	1916.....	3,474,000	3,213,000
1910.....	2,413,000	2,185,000	1917.....	4,480,000	4,317,000
1911.....	2,415,000	2,127,000	1918.....	6,708,000	6,185,000
1912.....	2,478,000	2,117,000	1919.....	6,820,000

RYE—Continued.

TABLE 58.—*Rye: Condition of crop, United States, on first of months named, 1892–1918.*

Year.	When harvested.					Year.	When harvested.				
	December of previous year.	April.	May.	June.	When harvested.		December of previous year.	April.	May.	June.	When harvested.
	<i>P. ct.</i>	<i>P. ct.</i>	<i>P. ct.</i>	<i>P. ct.</i>	<i>P. ct.</i>		<i>P. ct.</i>	<i>P. ct.</i>	<i>P. ct.</i>	<i>P. ct.</i>	<i>P. ct.</i>
1892.....	88.8	87.0	88.9	91.0	92.8	1906.....	95.4	90.9	92.9	89.9	91.3
1893.....	89.4	85.7	82.7	84.6	85.3	1907.....	96.2	92.0	88.0	88.1	89.7
1894.....	94.6	94.4	90.7	93.2	87.0	1908.....	91.4	89.1	90.3	91.3	91.2
1895.....	96.2	87.0	88.7	85.7	80.7	1909.....	87.6	87.2	88.1	89.6	91.4
1896.....	94.9	82.9	87.7	85.2	88.4	1910.....	94.1	92.3	91.3	90.6	87.5
1897.....	99.8	88.9	88.0	89.9	93.4	1911.....	92.6	89.3	90.0	88.6	85.0
1898.....	91.0	92.1	94.5	97.1	94.6	1912.....	93.3	87.9	87.5	87.7	88.2
1899.....	98.9	84.9	85.2	84.5	85.6	1913.....	93.5	89.3	91.0	90.9	88.6
1900.....	98.2	84.8	88.5	87.6	80.4	1914.....	95.3	91.3	93.4	93.6	92.9
1901.....	99.1	93.1	94.6	93.9	93.0	1915.....	93.6	89.5	93.3	92.0	92.0
1902.....	89.9	85.4	83.4	88.1	90.2	1916.....	91.5	87.8	88.7	86.9	87.0
1903.....	98.1	97.9	93.3	90.6	89.5	1917.....	88.8	86.0	88.8	84.3	79.4
1904.....	92.7	82.3	81.2	86.3	88.9	1918.....	81.1	83.8	85.8	83.6	80.8
1905.....	90.5	92.1	93.5	94.0	93.2	1919.....	89.0

TABLE 59.—*Rye: Yield per acre, price per bushel Dec. 1, and value per acre, by States.*

State.	Yield per acre (bushels).										Farm price per bushel (cents).					Value per acre (dollars). ¹			
	10-year average, 1909–1918.	1909	1910	1911	1912	1913	1914	1915	1916	1917	1918	10-year average, 1909–1918.	1914	1915	1916	1917	1918	5-year average, 1914–1918.	1918
Vt.....	19.2	15.5	17.5	22.5	20.0	18.0	20.0	17.0	20.0	20.0	21.0	109	80	85	120	175	166	24.86	34.86
Mass.....	18.3	16.2	17.0	16.0	18.5	18.5	19.0	20.0	18.5	19.0	20.0	125	101	102	127	200	227	29.30	45.40
Conn.....	19.7	18.7	20.0	18.5	17.5	19.3	19.0	21.5	19.6	20.5	22.0	119	98	102	125	210	205	30.64	45.10
N. Y.....	17.6	17.0	18.3	16.7	16.5	17.2	17.7	18.7	18.0	19.0	16.5	106	89	93	128	184	172	23.90	28.38
N. J.....	18.1	16.3	18.0	16.4	17.5	18.0	18.5	20.0	19.0	18.5	18.5	104	82	92	117	175	173	24.04	32.00
Pa.....	16.9	15.3	17.0	15.1	17.5	17.5	18.0	18.0	17.0	17.0	17.0	100	83	84	109	170	165	21.11	28.05
Del.....	15.1	14.0	15.5	15.0	14.0	14.0	17.5	15.5	15.0	16.0	14.5	106	92	99	123	178	171	20.63	24.80
Md.....	15.5	14.1	16.1	14.5	15.5	14.4	17.0	16.5	15.5	16.0	15.0	102	86	88	110	168	170	19.71	25.50
Va.....	12.9	12.3	13.5	11.5	12.5	12.3	13.0	14.5	12.5	15.0	12.0	106	90	93	107	175	175	17.16	21.00
W. Va.....	13.6	13.5	12.9	11.0	13.0	13.5	14.5	14.0	16.0	13.5	13.7	109	90	93	119	169	180	18.52	24.66
N. C.....	9.8	9.4	10.0	10.0	9.3	10.3	10.0	11.5	9.7	10.0	8.0	124	105	105	130	200	198	14.21	15.84
S. C.....	10.2	9.8	10.0	10.0	9.5	10.5	11.5	15.0	9.8	10.0	11.2	179	150	151	185	285	295	22.40	33.04
Ga.....	9.3	9.0	10.4	9.5	9.2	9.5	9.3	9.2	9.5	8.3	8.8	163	150	140	160	270	210	16.58	18.48
Ohio.....	16.5	17.2	16.5	15.5	15.5	16.5	17.0	17.5	14.5	18.0	17.0	97	81	83	120	161	150	20.03	25.50
Ind.....	15.4	16.5	15.8	13.7	14.5	15.2	16.3	16.0	14.0	15.0	16.5	95	85	82	119	160	152	18.54	25.08
Ill.....	17.1	17.8	17.4	16.8	16.0	16.5	16.0	18.5	15.5	17.5	19.0	97	85	83	122	165	150	21.05	28.50
Mich.....	14.7	15.5	15.3	14.6	13.3	14.3	16.0	15.5	14.3	14.0	14.3	97	91	85	130	165	150	18.18	21.45
Wis.....	17.2	16.3	16.0	17.0	18.3	17.5	16.5	18.5	16.2	18.5	17.6	97	91	87	132	169	150	22.03	26.40
Minn.....	18.8	19.0	17.0	18.0	20.0	19.0	18.8	19.5	15.0	18.5	20.0	91	89	81	127	175	152	22.50	30.00
Iowa.....	18.3	17.8	18.5	18.0	19.0	18.2	19.0	18.5	17.0	18.0	19.0	90	77	80	115	155	147	20.96	27.98
Mo.....	14.1	15.0	15.0	14.1	14.8	15.0	14.0	13.5	11.0	14.7	14.0	102	87	86	123	165	163	16.88	22.82
N. Dak.....	14.1	18.4	8.5	16.6	18.0	14.4	17.1	15.0	13.3	9.5	10.5	88	84	79	125	164	145	14.73	15.22
S. Dak.....	16.6	17.5	17.0	10.0	19.5	13.2	17.0	19.5	18.0	16.0	18.0	87	78	76	118	155	141	19.90	25.38
Nebr.....	15.4	16.5	16.0	13.0	16.0	14.5	16.0	17.5	16.0	15.6	12.9	86	74	73	116	155	135	16.96	17.42
Kans.....	14.8	14.2	14.0	11.0	15.9	14.0	20.0	16.0	14.5	14.0	14.3	98	80	76	110	167	170	18.36	24.31
Ky.....	12.6	12.7	13.0	12.0	13.0	12.4	13.7	12.0	11.2	12.5	13.6	110	95	94	129	175	161	16.51	21.90
Tenn.....	11.0	10.7	11.0	11.9	11.5	12.0	13.0	12.0	10.5	10.0	10.0	121	98	103	135	195	192	15.07	19.20
Ala.....	12.1	11.3	12.0	10.0	11.5	11.0	13.0	10.0	13.0	9.5	11.0	160	110	135	175	288	261	20.94	28.71
Tex.....	12.2	11.2	11.5	10.0	16.6	15.0	14.8	17.0	10.0	10.0	5.4	130	99	103	120	196	235	15.29	12.69
Okla.....	11.9	13.5	13.7	9.5	12.0	9.5	16.0	13.5	10.0	10.0	11.0	110	95	77	125	170	187	15.13	20.57
Ark.....	11.0	10.5	12.0	10.0	10.5	11.5	10.5	10.5	10.0	13.5	10.5	117	105	100	115	150	210	15.06	22.05
Mont.....	20.5	29.0	20.0	23.0	25.1	20.2	21.0	22.2	20.5	20.5	12.7	87	70	65	96	165	144	17.45	17.28
Wyo.....	18.7	26.0	18.5	20.0	19.0	19.0	17.0	20.0	15.5	14.0	18.0	98	81	90	108	155	152	19.51	27.36
Colo.....	16.2	22.0	14.0	12.0	19.5	17.0	17.5	17.5	14.0	16.0	12.0	85	65	70	105	146	140	15.70	16.80
Utah.....	15.4	22.0	18.5	15.5	15.0	17.0	17.5	15.5	12.0	8.0	13.0	90	60	65	100	160	180	13.76	23.40
Idaho.....	19.6	21.5	20.0	22.5	22.0	22.0	20.0	20.0	17.0	15.5	15.0	85	67	68	95	135	165	17.76	24.75
Wash.....	18.0	21.0	20.0	22.0	20.0	21.0	19.7	18.2	14.5	12.7	10.0	103	85	75	111	175	200	17.74	20.00
Oreg.....	16.1	17.0	15.1	19.5	16.0	17.5	16.0	18.0	17.0	12.7	12.0	112	100	90	115	170	205	19.59	24.60
U. S.....	15.9	16.1	16.0	15.6	16.8	16.2	16.8	17.3	15.2	14.6	14.4	96.8	86.5	83.4	122.1	166.0	151.5	18.71	21.82

¹ Based upon farm price Dec. 1.

RYE—Continued.

TABLE 60.—Rye: Farm price, cents per bushel on first of each month, 1909–1918.

Date.	1918	1917	1916	1915	1914	1913	1912	1911	1910	1909	Average.
Jan. 1.....	170.3	118.5	85.3	90.2	62.5	63.8	82.7	73.3	74.8	73.4	89.5
Feb. 1.....	174.8	123.5	88.3	100.6	61.7	68.9	84.4	73.1	76.1	73.8	92.5
Mar. 1.....	201.0	126.0	85.6	105.4	61.9	63.2	84.0	71.9	76.5	75.0	95.0
Apr. 1.....	235.1	135.6	83.6	100.4	63.0	62.9	85.1	75.4	76.6	77.3	99.5
May 1.....	221.1	164.1	83.7	101.9	62.9	62.4	84.6	75.8	74.9	78.8	101.0
June 1.....	187.6	183.0	83.8	98.1	64.4	64.1	86.1	77.9	74.8	81.2	100.1
July 1.....	170.0	177.1	83.3	93.7	63.1	63.2	83.6	76.9	74.6	81.7	96.7
Aug. 1.....	163.9	178.1	83.4	89.0	61.0	60.7	77.9	75.5	74.4	78.5	94.2
Sept. 1.....	159.3	169.9	99.7	85.5	75.4	63.0	70.8	76.9	74.1	72.4	93.9
Oct. 1.....	154.0	169.8	104.1	81.7	79.0	64.8	70.1	79.7	72.8	72.8	94.9
Nov. 1.....	152.6	168.8	115.3	85.7	80.1	63.2	68.8	83.1	71.6	73.6	96.3
Dec. 1.....	151.5	166.0	122.1	83.4	86.5	63.4	66.3	83.2	71.5	71.8	96.6
Average.....	167.4	156.5	99.7	89.2	72.8	63.8	74.9	78.1	73.7	74.2	95.0

TABLE 61.—Rye: Wholesale price per bushel, 1913–1918.

Date.	Philadelphia.			Cincinnati.			Chicago.			Duluth.			San Francisco (per 100 lbs.).		
	Low.	High.	Average.	No. 2.			No. 2.			Low.	High.	Average.	Low.	High.	Average.
				Low.	High.	Average.	Low.	High.	Average.						
1913.	Cts.	Cts.	Cts.	Cts.	Cts.	Cts.	Cts.	Cts.	Cts.	Cts.	Cts.	Cts.	Cts.	Cts.	Cts.
Jan.-June.....	65	70	60	70	65.8	58	65½	62.5	52	59	55.6	132½	147½	140.0
July-Dec.....	65	77	60	72	65.3	61	70½	64.9	50	65	56.4	135	165	145.0
1914.															
Jan.-June.....	65	75	62	71	65.7	58	67	62.8	50	62	56.3	152½	165	159.1
July-Dec.....	65	125	109.4	60	115	92.6	55	112½	89.2	57	107	86.6	130	165	154.2
1915.															
Jan.-June.....	105	130	117.0	107	133	115.9	111½	131	118.9	106	128	114.2	160	225	186.6
July-Dec.....	90	112	92	112	102.1	91	119	100.3	87	111	94.4	145	165	156.5
1916.															
Jan.-June.....	90	118	90	106	98.9	90	104½	97.8	89	98	93.4	150	160	155.4
July-Dec.....	90	155	138.3	96	155	127.3	94	153	125.5	87	150	123.0	152½	265	197.6
1917.															
January.....	140	155	151.5	140	152	148.1	138	148½	145.9	136	144	139.9	250	265	257.5
February.....	140	158	149.0	146	154	149.6	140	152	146.0	134	147	139.3	240	265	251.2
March.....	153	175	163.4	153	164	158.4	152	170	161.1	147	165	155.6	240	250	245.0
April.....	170	205	189.4	170	192	182.1	168	205	189.7	164	200	182.6	230	305	267.4
May.....	200	245	227.1	200	220	208.6	200	240	226.3	198	240	220.5	350	400	376.8
June.....	235	245	240.8	230	240	233.8	230	245	240.4	218	235	228.5
Jan.-June.....	140	245	186.9	140	240	180.1	138	245	184.9	134	240	177.7	230	400	279.6
July.....	240	245	242.5	220	280	238.8	210	243	222.9	185	298	225.8	290	300	295.5
August.....	170	215	187.7	165	215	185.1	168	190	179.0	290	300	295.0
September.....	174	190	183.8	179	192	186.5	180	190	184.8	290	350	313.6
October.....	177	188	181.8	178	190½	182.0	175	186	178.8	325	400	340.1
November.....	173	186	178.8	170	180	176.1	176	180½	178.4	174	178	175.9	390	400	395.0
December.....	175	186	180.5	179	184	180.1	176	184	179.9	179	184½	182.6	390	400	395.0
July-Dec.....	173	245	200.6	170	280	191.4	165	243	189.1	168	298	187.8	290	400	339.0
1918.															
January.....	175	188	177.7	179	204	186.1	183	218	192.5	182	215	190.4	390	425	401.3
February.....	178	188	183.0	206	235	218.6	212	265	227.8	210	260	222.6	400	425	412.5
March.....	265	280	273.8	272	295	285.7	260	300	285.3	400	425	412.5
April.....	205	275	240.9	240	287	264.2	248	294	267.2	400	425	412.5
May.....	185	250	213.0	180	260	215.6	267	267	267.0
June.....	175	190	181.2	160	200	185.7
Jan.-June.....	175	188	180.4	175	280	218.9	160	295	228.6	182	300	246.5	390	425	409.7
July.....	170	170	170.0	155	170	161.9	160	185	171.9	184	186	185.0
August.....	165	170	167.3	155	167	160.5	155	179	163.6	160	165	166.8
September.....	165	173½	168.5	155	162	159.2	165	179	162.8	158	164	163.0
October.....	176½	176½	176.2	160	163	161.4	161	164	162.4	161	161	161.0
November.....	176½	176½	176.5	155	164	160.2	160½	176½	162.2	150½	169½	161.6
December.....	176½	176½	176.5	159	163	161.2	154	164	162.1	150	158½	156.1
July-Dec.....	165	176½	172.5	155	170	160.7	154	185	164.5	150	186	165.6

RYE—Continued.

TABLE 62.—Rye (including flour): International trade, calendar years 1911-13, 1916-17.

[See "General note," Table 11.]

EXPORTS.

[000 omitted.]

Country.	Average 1911-1913.	1916 (prelim.)	1917 (prelim.)	Country.	Average 1911-1913.	1916 (prelim.)	1917 (prelim.)
FROM—	<i>Bushels.</i>	<i>Bushels.</i>	<i>Bushels.</i>	FROM—	<i>Bushels.</i>	<i>Bushels.</i>	<i>Bushels.</i>
Argentina.....	443	129	Roumania.....	3,411
Belgium.....	914	Russia.....	34,921	12,315
Bulgaria.....	2,336	United States.....	855	15,838	14,689
Canada.....	69	989	833	Other countries.....	514
Denmark.....	303	1	Total.....	107,587
Germany.....	44,951				
Netherlands.....	18,870	14				

IMPORTS.

INTO—				INTO—			
Austria-Hungary...	1,224	Norway.....	10,520	7,329	5,095
Belgium.....	6,157	Russia.....	5,231
Denmark.....	8,587	2,313	Sweden.....	3,769
Finland.....	15,472	12,639	Switzerland.....	729	42
France.....	4,138	14	United Kingdom.....	2,195	2,054
Germany.....	16,900	Other countries.....	677
Italy.....	721	1	1,440	Total.....	107,343
Netherlands.....	31,023	721				

BUCKWHEAT.

TABLE 63.—Buckwheat: Acreage, production, and value in the United States, 1849-1918.

NOTE.—Figures in *italics* are census returns; figures in roman are estimates of the Department of Agriculture. Estimates of acres are obtained by applying estimated percentages of increase or decrease to the published numbers of the preceding year, except that a revised base is used for applying percentage estimates whenever new census data are available.

Year.	Acreage (thousands of acres).	Average yield per acre (bushels).	Production (thousands of bushels).	Average farm price Dec. 1 (cents per bushel).	Farm value Dec. 1 (thousands of dollars).	Year.	Acreage (thousands of acres).	Average yield per acre (bushels).	Production (thousands of bushels).	Average farm price Dec. 1 (cents per bushel).	Farm value Dec. 1 (thousands of dollars).
1849.....	8,957	1891.....	849	15.0	12,761	57.0	7,272
1859.....	17,572	1892.....	861	14.1	12,143	51.8	6,296
1866.....	1,046	21.8	22,792	67.6	15,413	1893.....	816	14.9	12,132	58.3	7,074
1867.....	1,228	17.4	21,359	78.7	16,812	1894.....	789	16.1	12,668	55.6	7,040
1868.....	1,114	17.8	19,864	78.0	15,490	1895.....	763	20.1	15,341	45.2	6,936
1869.....	1,029	16.9	17,431	71.9	12,535	1896.....	755	18.7	14,090	39.2	5,522
1869.....	9,822	1897.....	718	20.9	14,997	42.1	6,319
1870.....	537	18.3	9,842	70.5	6,937	1898.....	678	17.3	11,722	45.0	5,271
1871.....	414	20.1	8,329	74.5	6,208	1899.....	670	16.6	11,094	55.7	6,184
1872.....	448	18.1	8,134	73.5	5,979	1899.....	807	13.9	11,234
1873.....	454	17.3	7,838	75.0	5,879	1900.....	638	15.0	9,567	55.8	5,341
1874.....	453	17.7	8,017	72.9	5,844	1901.....	811	18.6	15,126	56.3	8,523
1875.....	576	17.5	10,082	62.0	6,255	1902.....	805	18.1	14,530	59.6	8,655
1876.....	666	14.5	9,669	66.6	6,436	1903.....	804	17.7	14,244	60.7	8,651
1877.....	650	15.7	10,177	66.9	6,808	1904.....	794	18.9	15,008	62.2	9,331
1878.....	673	18.2	12,247	52.6	6,441	1905.....	760	19.2	14,585	58.7	8,565
1879.....	640	20.5	13,140	59.8	7,856	1906.....	789	18.6	14,642	59.6	8,727
1879.....	848	13.9	11,817	1907.....	800	17.9	14,290	69.8	9,975
1880.....	823	17.8	14,618	59.4	8,682	1908.....	803	19.8	15,874	75.6	12,004
1881.....	829	11.4	9,486	86.5	8,206	1909.....	834	20.9	17,438
1882.....	847	13.0	11,019	73.0	8,039	1909.....	878	16.9	14,849	70.1	10,346
1883.....	857	8.9	7,669	82.2	6,304	1910.....	860	20.5	17,598	66.1	11,636
1884.....	879	12.6	11,116	58.9	6,549	1911.....	833	21.1	17,549	72.6	12,735
1885.....	914	13.8	12,626	55.9	7,057	1912.....	841	22.9	19,249	66.1	12,720
1886.....	918	12.9	11,869	54.5	6,465	1913.....	805	17.2	13,833	75.5	10,445
1887.....	911	11.9	10,844	56.5	6,122	1914.....	792	21.3	16,881	76.4	12,892
1888.....	913	13.2	12,050	63.3	7,628	1915.....	769	19.6	15,056	78.7	11,843
1889.....	837	14.5	12,110	50.5	6,113	1916.....	828	14.1	11,662	112.7	13,147
1889.....	837	14.5	12,110	1917.....	924	17.3	16,022	160.0	25,631
1890.....	845	14.7	12,433	57.2	7,110	1918.....	1,040	16.5	17,182	166.4	28,585

1 Figures adjusted to census basis.

BUCKWHEAT—Continued.

TABLE 64.—*Buckwheat: Revised acreage, production, and farm value, 1879 and 1889–1909.*

[See head note of Table 4.]

Year.	Acreage.	Average yield per acre.	Production.	Average farm price per bushel Dec. 1.	Farm value Dec. 1.
1879.....	848,000	20.7	17,530,000	60.3	10,575,000
1889.....	837,000	14.5	12,109,000	50.5	6,115,000
1890.....	863,000	14.7	12,678,000	57.3	7,264,000
1891.....	867,000	15.0	13,013,000	57.0	7,422,000
1892.....	899,000	14.1	12,643,000	52.0	6,573,000
1893.....	873,000	14.7	12,866,000	58.3	7,503,000
1894.....	864,000	15.9	13,721,000	55.7	7,638,000
1895.....	842,000	19.9	16,748,000	45.3	7,583,000
1896.....	853,000	18.5	15,805,000	39.3	6,211,000
1897.....	838,000	20.6	17,260,000	42.1	7,259,000
1898.....	811,000	17.2	13,961,000	45.0	6,278,000
1899.....	807,000	16.1	13,001,000	55.9	7,263,000
1900.....	795,000	14.9	11,810,000	55.8	6,588,000
1901.....	852,000	18.4	15,693,000	56.4	8,857,000
1902.....	856,000	17.9	15,286,000	59.6	9,110,000
1903.....	870,000	17.5	15,248,000	60.8	9,277,000
1904.....	876,000	18.6	16,327,000	62.5	10,208,000
1905.....	840,000	18.8	15,797,000	58.6	9,261,000
1906.....	865,000	18.2	15,734,000	59.7	9,386,000
1907.....	838,000	17.7	14,858,000	70.0	10,397,000
1908.....	853,000	19.4	16,541,000	75.7	12,518,000
1909.....	878,000	20.5	17,983,000	70.2	12,628,000

TABLE 64A.—*Buckwheat: Acreage, production, and total farm value, by States, 1918.*

[000 omitted.]

State.	Acreage.	Production.	Farm value Dec. 1.	State.	Acreage.	Production.	Farm value Dec. 1.
	<i>Acres.</i>	<i>Bushels.</i>	<i>Dollars.</i>		<i>Acres.</i>	<i>Bushels.</i>	<i>Dollars.</i>
Maine.....	21	420	630	Ohio.....	28	448	699
New Hampshire.....	2	34	68	Indiana.....	24	360	576
Vermont.....	14	294	470	Illinois.....	4	71	128
Massachusetts.....	2	32	63	Michigan.....	78	780	1,326
Connecticut.....	8	152	319	Wisconsin.....	40	636	1,049
New York.....	315	4,725	8,269	Minnesota.....	15	255	434
New Jersey.....	17	306	520	Iowa.....	16	240	432
Pennsylvania.....	325	5,850	9,360	Missouri.....	7	91	164
Delaware.....	4	82	117	Nebraska.....	2	28	46
Maryland.....	14	280	462	Tennessee.....	5	90	126
Virginia.....	38	798	1,301	United States.....	1,040	17,182	28,585
West Virginia.....	47	916	1,585				
North Carolina.....	14	294	441				

TABLE 65.—*Buckwheat: Condition of crop, United States, on first of months named, 1898–1918.*

Year.	Aug.	Sept.	When harvested.	Year.	Aug.	Sept.	When harvested.	Year.	Aug.	Sept.	When harvested.
	<i>P. ct.</i>	<i>P. ct.</i>	<i>P. ct.</i>		<i>P. ct.</i>	<i>P. ct.</i>	<i>P. ct.</i>		<i>P. ct.</i>	<i>P. ct.</i>	<i>P. ct.</i>
1898.....	87.2	88.8	76.2	1905.....	92.6	91.8	91.6	1912.....	88.4	91.6	89.2
1899.....	93.2	75.2	70.2	1906.....	93.2	91.2	84.9	1913.....	85.5	75.4	65.9
1900.....	87.9	80.5	72.8	1907.....	91.9	77.4	80.1	1914.....	88.8	87.1	83.3
1901.....	91.1	90.9	90.5	1908.....	89.4	87.8	81.6	1915.....	92.6	88.6	81.9
1902.....	91.4	86.4	80.5	1909.....	86.4	81.0	79.5	1916.....	87.8	78.5	66.9
1903.....	93.9	91.0	83.0	1910.....	87.9	82.3	81.7	1917.....	92.2	90.2	74.8
1904.....	92.8	91.5	88.7	1911.....	82.9	83.8	81.4	1918.....	88.6	83.3	75.6

BUCKWHEAT—Continued.

TABLE 66.—*Buckwheat: Yield per acre, price per bushel Dec. 1, and value per acre, by States.*

State.	Yield per acre (bushels).										Farm price per bushel (cents.)					Value per acre (dollars). ¹			
	10-year average, 1909-1918.	1909	1910	1911	1912	1913	1914	1915	1916	1917	1918	10-year average, 1909-1918.	1914	1915	1916	1917	1918	5-year average, 1914-1918.	1918
	Me.	27.2	28.0	32.5	30.0	29.4	32.0	29.0	26.0	24.0	21.5	20.0	86	60	70	95	150	150	24.13
N. H.	25.0	22.0	31.0	27.3	31.0	31.0	25.0	30.0	20.0	16.0	17.0	99	70	81	109	183	200	25.02	34.00
Vt.	23.9	22.0	24.0	24.3	30.0	25.0	28.0	27.0	17.5	20.0	21.0	96	82	82	105	150	160	25.42	33.60
Mass.	18.2	19.3	22.0	21.0	21.0	17.0	18.5	16.0	16.0	15.0	16.0	110	84	95	140	166	196	21.88	31.36
Conn.	18.9	19.5	19.5	19.0	20.5	17.0	18.5	20.0	19.0	17.3	19.0	118	95	96	120	200	210	26.82	39.90
N. Y.	19.3	24.0	23.0	21.3	23.8	14.3	23.0	19.0	12.0	18.0	15.0	96	76	80	122	160	175	20.47	26.25
N. J.	20.4	21.8	21.5	20.0	22.0	21.0	21.0	19.0	18.0	18.0	19.0	97	83	83	108	158	172	28.88	30.60
Pa.	19.5	19.5	19.5	21.9	24.2	18.5	20.5	21.0	14.0	18.0	18.0	92	76	78	111	163	160	21.13	28.80
Del.	18.9	19.8	20.5	19.0	16.0	17.0	19.0	18.5	19.0	20.0	20.5	88	76	75	118	148	143	21.93	29.32
Md.	18.8	16.6	18.5	20.0	17.5	16.5	18.5	20.0	19.0	21.0	20.0	95	81	72	110	165	165	23.59	33.00
Va.	19.7	18.0	18.0	16.0	21.5	23.1	19.4	20.0	19.2	21.1	21.0	95	84	80	95	150	163	23.28	34.23
W. Va.	21.6	22.7	23.0	24.0	24.0	21.0	21.5	22.0	18.3	20.0	19.5	100	83	80	101	170	173	24.33	33.74
N. C.	19.0	19.8	19.0	19.0	17.5	19.3	19.0	17.5	17.5	20.0	21.0	93	83	82	85	130	150	20.50	31.50
Ohio.	19.6	21.2	18.0	21.0	19.5	18.0	24.0	23.0	17.7	17.2	16.0	95	76	77	110	153	156	21.34	24.96
Ind.	17.0	17.3	17.7	18.3	19.0	18.5	17.5	14.0	18.0	15.0	15.0	95	78	80	112	155	160	18.45	24.00
Ill.	18.4	18.2	20.0	18.1	22.0	17.0	17.7	17.0	17.0	19.0	17.8	109	95	90	130	170	180	23.71	32.04
Mich.	14.3	14.3	15.3	18.0	17.0	15.0	18.5	14.5	11.0	9.0	10.0	91	71	72	115	147	170	13.29	17.00
Wis.	15.0	12.3	14.0	17.5	17.0	16.5	17.5	13.0	14.0	12.2	15.9	98	76	83	116	174	165	17.56	26.24
Minn.	16.7	15.2	16.0	18.0	21.0	16.5	17.0	17.5	15.0	14.0	17.0	91	70	75	112	135	170	17.92	28.90
Iowa.	15.4	15.0	14.9	17.5	19.0	14.0	18.3	13.0	15.0	12.0	15.0	108	77	80	125	200	180	18.85	27.00
Mo.	14.6	21.0	16.5	10.0	15.0	11.0	15.5	15.0	14.0	15.0	13.0	110	93	90	133	144	180	18.31	23.40
Nebr.	17.6	16.0	20.0	16.0	18.0	20.0	18.5	20.0	17.0	16.0	14.0	105	84	95	110	150	165	20.07	23.10
Tenn.	17.2	15.0	15.0	16.0	18.0	15.0	22.3	18.0	18.0	17.0	18.0	94	78	76	100	150	140	19.95	25.20
U. S.	19.1	20.9	20.5	21.1	22.9	17.2	21.3	19.6	14.1	17.3	16.5	94.4	76.4	78.7	112.7	160.0	166.4	20.56	27.49

¹ Based upon farm price Dec. 1.

TABLE 67.—*Buckwheat: Farm price, cents per bushel on first of each month, 1909-1918.*

	1918	1917	1916	1915	1914	1913	1912	1911	1910	1909	Average.
Jan. 1	162.7	117.2	81.5	77.9	76.6	66.8	73.7	65.8	70.0	74.3	86.6
Feb. 1	161.9	114.6	80.7	83.7	75.6	69.4	73.6	64.4	72.0	74.2	87.0
Mar. 1	168.2	124.8	83.2	85.5	75.1	67.0	76.9	64.1	70.6	75.5	89.1
Apr. 1	170.1	128.3	83.1	85.3	76.9	68.3	76.9	65.3	73.4	76.2	90.4
May 1	176.0	150.6	84.0	84.6	77.3	71.4	79.9	65.8	71.0	78.8	94.0
June 1	191.0	183.7	87.0	86.9	79.0	70.8	84.8	70.1	73.7	83.4	101.0
July 1	200.8	209.2	93.1	92.1	85.5	72.9	86.2	72.4	78.0	86.9	107.7
Aug. 1	192.7	189.3	89.0	89.2	81.2	72.4	83.6	76.0	74.8	82.9	103.1
Sept. 1	189.2	164.3	86.4	81.4	79.8	70.0	76.6	74.0	72.6	76.9	97.1
Oct. 1	180.0	154.4	90.4	73.7	78.7	74.1	69.7	69.6	71.3	75.0	93.7
Nov. 1	173.0	154.2	102.9	78.5	78.0	75.5	65.5	73.0	65.9	71.6	93.8
Dec. 1	166.4	160.0	112.7	78.7	76.4	75.5	66.1	72.6	66.1	70.1	94.5
Average	174.6	153.2	94.7	81.0	77.9	72.4	72.6	70.3	69.8	75.0	94.2

FLAX.

TABLE 68.—Flax: Area and production in undermentioned countries, 1915–1917.

[000 omitted.]

Country.	Area.			Production.					
	1915	1916	1917	Seed.			Fiber.		
				1915	1916	1917	1915	1916	1917
NORTH AMERICA	<i>Acres.</i>	<i>Acres.</i>	<i>Acres.</i>	<i>Bush.</i>	<i>Bush.</i>	<i>Bush.</i>	<i>Pounds.</i>	<i>Pounds.</i>	<i>Pounds.</i>
United States.....	1,387	1,474	1,984	14,030	14,296	9,164			
Canada:									
Quebec.....	1	1	6	7	5	7			
Ontario.....	5	4	4	62	42	52			
Manitoba.....	14	16	16	120	210	147			
Saskatchewan.....	395	542	754	5,255	6,692	4,710			
Alberta.....	48	95	140	670	1,311	979			
Total Canada.....	463	658	920	6,114	8,260	5,935			
Mexico.....	(1)			110					
Total.....				20,254	22,556				
SOUTH AMERICA.									
Argentina.....	4,258	4,001	3,207	45,040	39,289	3,996			
Uruguay.....	101	44	36	588	391	122			
Total.....	4,359			45,628	39,680	4,118			
EUROPE.									
Austria-Hungary:									
Austria ²	44			332			26,110		
Hungary proper.....	³ 32			³ 255			³ 29,999		
Croatia-Slavonia.....	³ 16			³ 18			³ 8,640		
Bosnia-Herzegovina.....	(1)			³ 4			³ 1,000		
Total, Austria-Hungary.....				609			65,749		
Belgium.....	⁴ 32			³ 387			³ 39,437		
Bulgaria.....	⁴ 2			³ 8			³ 308		
France ⁶	20	15	20	161	146	134	11,061		8,909
Ireland.....	53	91	108				21,648	32,461	34,410
Italy.....	21	21	20	323	362	323	5,512	5,512	5,291
Netherlands.....	22	30	30	295	367	222	12,922		11,756
Romania.....	14	20		134			1,187		
Russia:									
Russia proper.....	2,843	3,505		16,593					
Poland.....	² 88			² 878					
Northern Caucasia.....	48			499					
Total.....	2,979			17,970			815,438		
Serbia.....	⁴ 4	(1)					⁴ 2,095		
Spain.....	3	3	4			22	(1)	(1)	1,520
Sweden ⁷	⁵ 3	(1)		3	3		328	333	
Total.....									
ASIA.									
British India ⁸	3,325	3,334	3,564	15,880	19,040	21,040			
Japan.....			61						
Russia:									
Central Asia (4 govern- ments of).....	83			566					
Siberia (4 governments of).....	152			796					
Transcaucasia (1 gov- ernment of).....	³ 30			³ 258					
Total.....	265			17,500					
AFRICA.									
Algeria.....	⁴ 1	(1)	1	³ 15	(1)				
Grand total.....				103,287			975,685		

¹ No official estimates.

² Galicia and Bukovina not included.

³ Data for 1913.

⁴ Data for 1914.

⁵ Data for 1912.

⁶ Excludes territory occupied by the enemy.

⁷ Includes hemp.

⁸ Includes certain native states.

FLAX—Continued.

TABLE 69.—*Flax (seed and fiber): Total production of countries named in Table 68, 1896–1915.*

Year.	Production.		Year.	Production.	
	Seed.	Fiber.		Seed.	Fiber.
	<i>Bushels.</i>	<i>Pounds.</i>		<i>Bushels.</i>	<i>Pounds.</i>
1896.....	82,684,000	1,714,205,000	1906.....	88,165,000	1,871,723,000
1897.....	57,596,000	1,498,054,000	1907.....	102,960,000	2,042,390,000
1898.....	72,938,000	1,780,693,000	1908.....	100,850,000	1,907,591,000
1899.....	66,348,000	1,138,763,000	1909.....	100,820,000	1,384,524,000
1900.....	62,432,000	1,315,931,000	1910.....	85,253,000	913,112,000
1901.....	72,314,000	1,050,260,000	1911.....	101,339,000	1,011,350,000
1902.....	83,891,000	1,564,840,000	1912.....	130,291,000	1,429,967,000
1903.....	110,455,000	1,492,383,000	1913.....	132,477,000	1,384,757,000
1904.....	107,743,000	1,517,922,000	1914.....	94,559,000	1,042,746,000
1905.....	100,458,000	1,494,229,000	1915.....	103,287,000	975,685,000

TABLE 70.—*Flaxseed: Acreage, production, value, and condition in the United States, 1849–1918.*

NOTE.—Figures in *italics* are census returns; figures in roman are estimates of the Department of Agriculture. Estimates of acres are obtained by applying estimated percentages of increase or decrease to the published numbers of the preceding year, except that a revised base is used for applying percentage estimates whenever new census data are available.

Year.	Acreage.	Average yield per acre.	Production.	Average farm price per bushel Dec. 1.	Farm value Dec. 1.	Condition of growing crop.			
						July 1.	Aug. 1.	Sept. 1.	When harvested.
	<i>Acres.</i>	<i>Bushels.</i>	<i>Bushels.</i>	<i>Cents.</i>	<i>Dollars.</i>	<i>P. ct.</i>	<i>P. ct.</i>	<i>P. ct.</i>	<i>P. ct.</i>
1849.....			562,000						
1859.....			567,000						
1869.....			1,730,000						
1879.....			7,171,000						
1889.....	1,519,000	7.8	10,250,000						
1899.....	2,111,000	9.5	19,979,000						
1902.....	3,740,000	7.8	29,285,000	105.2	30,815,000				
1903.....	3,233,000	8.4	27,301,000	81.7	22,292,000	86.2	80.3	80.5	74.0
1904.....	2,264,000	10.3	23,401,000	99.3	23,229,000	86.6	78.9	85.8	87.0
1905.....	2,535,000	11.2	28,478,000	84.4	24,049,000	92.7	96.7	94.2	91.5
1906.....	2,506,000	10.2	25,576,000	101.3	25,899,000	93.2	92.2	89.0	87.4
1907.....	2,864,000	9.0	25,851,000	95.6	24,713,000	91.2	91.9	85.4	78.0
1908.....	2,679,000	9.6	25,805,000	118.4	30,577,000	92.5	86.1	82.5	81.2
1909.....	2,742,000	9.4	25,856,000						
1909.....	2,033,000	9.4	19,513,000	153.0	29,796,000	95.1	92.7	88.9	84.9
1910.....	2,467,000	5.2	12,718,000	231.7	29,472,000	65.0	51.7	48.3	47.2
1911.....	2,757,000	7.0	19,370,000	182.1	35,272,000	80.9	71.0	68.4	69.6
1912.....	2,851,000	9.8	28,073,000	114.7	32,202,000	88.9	87.5	86.3	83.8
1913.....	2,291,000	7.8	17,853,000	119.9	21,399,000	82.0	77.4	74.9	74.7
1914.....	1,645,000	8.4	13,749,000	126.0	17,318,000	90.5	82.1	72.9	77.4
1915.....	1,387,000	10.1	14,030,000	174.0	24,410,000	88.5	91.2	87.6	84.5
1916.....	1,474,000	9.7	14,296,000	248.6	35,541,000	90.3	84.0	84.8	86.2
1917.....	1,984,000	4.6	9,164,000	296.6	27,182,000	84.0	60.6	50.2	51.3
1918.....	1,938,000	7.6	14,657,000	340.2	49,870,000	79.8	70.6	72.6	70.8

¹ Figures adjusted to census basis.

FLAX—Continued.

TABLE 71.—Flaxseed: Acreage, production, and total farm value, by States, 1918.

State.	Acreage.	Average yield per acre.	Production.	Average farm price per bushel Dec. 1.	Farm value Dec. 1.
	<i>Acres.</i>	<i>Bushels.</i>	<i>Bushels.</i>	<i>Dollars.</i>	<i>Dollars.</i>
Minnesota.....	300,000	10.4	3,120,000	3.41	10,639,000
Iowa.....	13,000	11.0	143,000	3.20	458,000
Missouri.....	6,000	8.0	48,000	3.00	144,000
North Dakota.....	880,000	7.8	6,864,000	3.45	23,681,000
South Dakota.....	144,000	9.5	1,368,000	3.25	4,446,000
Nebraska.....	4,000	9.5	38,000	3.30	125,000
Kansas.....	41,000	5.0	205,000	3.30	676,000
Montana.....	547,000	5.2	2,844,000	3.38	9,613,000
Wyoming.....	3,000	9.0	27,000	3.25	88,000
United States.....	1,938,000	7.6	14,657,000	3.40	49,870,000

TABLE 72.—Flaxseed: Yield per acre, price per bushel Dec. 1, and value per acre, by States.

State.	Yield per acre (bushels).										Farm price per bushel (cents).					Value per acre (dollars). ¹			
	10-year aver- age, 1909-1918	1909	1910	1911	1912	1913	1914	1915	1916	1917	1918	10-year aver- age, 1909-1918	1914	1915	1916	1917	1918	5-year average, 1914-1918	1918
	Minn.....	9.3	10.0	7.5	8.0	10.2	9.0	9.3	10.5	8.5	9.5	10.4	198	128	176	240	295	341	22.85
Iowa.....	10.1	9.8	12.2	8.0	11.5	9.4	9.5	9.0	10.0	11.0	11.0	186	120	150	215	275	320	22.37	35.20
Mo.....	7.0	8.1	8.4	3.0	6.0	5.0	8.0	8.0	7.0	8.5	8.0	177	104	135	212	275	300	16.27	24.00
N. Dak.....	7.8	9.3	3.6	7.6	9.7	7.2	8.3	9.9	10.3	3.9	7.8	201	128	178	252	300	345	18.56	26.91
S. Dak.....	8.0	9.4	5.0	5.3	8.6	7.2	7.5	11.0	9.3	7.0	9.5	195	123	167	247	299	325	20.47	30.88
Nebr.....	7.8	8.5	8.0	5.0	9.5	6.0	7.0	11.0	8.0	5.5	9.5	185	119	147	230	250	330	17.60	31.35
Kans.....	6.0	7.0	8.2	3.0	6.0	6.0	6.0	5.7	5.8	7.0	5.0	188	125	145	234	290	330	13.23	16.50
Mont.....	8.4	12.0	7.0	7.7	12.0	9.0	8.0	10.5	9.5	3.0	5.2	198	120	170	248	295	338	15.49	17.58
Wyo.....	9.3	10.0	12.0	9.9	7.0	13.0	7.0	6.5	9.0	239	145	225	261	325	16.16	29.25
U. S.....	8.0	9.4	5.2	7.0	9.8	7.8	8.4	10.1	9.7	4.6	7.6	198.6	126.0	174.0	248.6	296.6	340.2	18.33	25.73

¹ Based upon farm price Dec. 1.

TABLE 73.—Flaxseed: Farm price, cents per bushel on first of each month, 1909-1918.

	1918	1917	1916	1915	1914	1913	1912	1911	1910	1909	Average.
Jan. 1.....	310.8	250.7	185.9	134.8	124.2	106.2	187.1	221.1	171.2	123.2	181.5
Feb. 1.....	326.7	253.7	210.9	163.7	127.8	109.3	190.8	233.9	192.9	129.8	194.0
Mar. 1.....	349.8	253.1	202.5	157.9	132.5	119.0	183.9	240.7	193.1	141.3	197.4
Apr. 1.....	379.7	266.1	202.1	167.7	132.8	113.6	191.3	234.6	193.9	145.6	202.7
May 1.....	373.3	300.6	191.8	169.6	134.7	114.3	181.0	241.9	209.5	148.7	206.5
June 1.....	363.6	298.8	176.5	169.5	136.8	115.8	205.0	225.0	195.5	153.4	204.0
July 1.....	349.3	278.0	163.2	152.5	136.0	113.4	198.4	205.6	183.5	153.2	193.3
Aug. 1.....	410.5	271.6	178.1	144.6	150.7	118.6	175.2	199.2	209.7	137.0	199.5
Sept. 1.....	381.2	302.8	190.2	143.5	139.3	127.8	162.6	203.6	220.0	123.1	199.4
Oct. 1.....	380.9	308.5	199.2	148.1	127.4	122.6	147.7	205.0	234.3	122.8	199.6
Nov. 1.....	333.8	295.9	234.7	162.9	118.7	118.7	133.4	210.6	229.4	139.8	197.8
Dec. 1.....	340.2	296.6	248.6	174.0	126.0	119.9	114.7	182.1	231.7	152.9	198.7
Average.....	345.5	288.7	218.4	159.5	125.6	117.7	148.6	207.8	217.9	138.5	196.8

FLAX—Continued.

TABLE 74.—Flaxseed: Wholesale price per bushel, 1913-1918.

Date.	Cincinnati.			Minneapolis.			Milwaukee.			Duluth.		
	Low.	High.	Average.	Low.	High.	Average.	No. 1. Northwest- ern.			Low.	High.	Average.
							Low.	High.	Average.			
1913.												
Jan.-June.....	\$1.50	\$1.50	\$1.50	\$1.23½	\$1.40	\$1.25½	\$1.42½	\$1.31	\$1.22½	\$1.39	\$1.30
July-Dec.....	1.50	1.50	1.50	1.31½	1.53½	1.30½	1.54½	1.41	1.34½	1.53½	1.42
1914.												
Jan.-June.....	1.50	1.50	1.50	1.47½	1.61½	\$1.55	1.45½	1.75	1.57	1.48	1.63½	1.56
July-Dec.....	1.40	1.50	1.41	1.28	1.88	1.52	1.30	1.93	1.56	1.28½	1.93	1.53
1915.												
Jan.-June.....	1.70	1.80	1.59½	2.08½	1.87	1.51½	2.05	1.86	1.61½	2.09	1.89
July-Dec.....	1.70	1.70	1.52½	2.21	1.82	1.52½	2.18	1.81	1.53	2.20½	1.82
1916.												
Jan.-June.....	2.85	2.85	2.85	1.73½	2.41½	2.14	1.73½	2.38	2.11	1.76	2.43½	2.12
July-Dec.....	1.50	2.85	2.05	1.60	2.94	2.38	1.77	2.89	2.37	1.80	2.94½	2.41
1917.												
January.....	2.25	2.25	2.25	2.83½	2.94½	2.89	2.83½	2.91½	2.87	2.85½	2.92½	2.89
February.....	2.25	2.25	2.25	2.75	2.93½	2.82	2.75½	2.82½	2.78	2.78	2.86	2.81
March.....	2.25	2.25	2.25	2.75½	3.00	2.89	2.75½	2.91	2.85	2.79½	2.95½	2.89
April.....	2.60	2.80	2.65	2.21½	3.39	3.15	2.93	3.33	3.15	2.98	3.39	3.21
May.....	3.00	3.25	3.09	2.92	3.61	3.32	2.92	3.55	3.30	2.95	3.64	3.26
June.....	3.25	3.25	3.25	2.87	3.32	3.13	2.81½	3.26	3.08	2.85½	3.28	3.09
Jan.-June.....	2.25	3.25	2.62	2.21½	3.61	3.03	2.75½	3.55	3.00	2.78	3.64	3.04
July.....	3.25	3.25	3.25	2.64	3.36	3.01	2.68	3.30	2.99	2.69	3.35	3.04
August.....	3.25	3.30	3.28	3.30	3.76	3.46	3.26	3.71	3.42	3.28	3.79	3.49
September.....	3.30	3.30	3.30	3.16	3.55½	3.40	3.16	3.55	3.38	3.24	3.57	3.41
October.....	3.30	3.30	3.30	3.05	3.35½	3.17	3.01½	3.30½	3.16	3.02½	3.32½	3.14
November.....	3.30	4.20	3.76	3.18½	3.43	3.29	3.18½	3.41	3.28	3.00	3.46	3.27
December.....	4.20	4.25	4.21	3.21	3.57	3.40	3.21	3.54	3.36	3.21	3.54	3.36
July-Dec.....	3.25	4.25	3.52	2.64	3.76	3.29	2.68	3.71	3.26	2.69	3.79	3.28
1918.												
January.....	4.25	4.25	4.25	3.45½	3.66	3.99	3.50	3.62	3.58	3.46	3.73	3.59
February.....	3.75	3.75	3.75	3.60½	3.94	3.74	3.61½	3.98	3.72	3.52	4.09	3.75
March.....	3.75	3.75	3.75	4.00	4.34	4.16	4.00	4.32½	4.15	3.98	4.36	4.19
April.....	3.75	3.75	3.75	4.00	4.15	4.10	3.98	4.16	4.08	3.95	4.21½	4.10
May.....	3.75	3.75	3.75	3.70½	4.07	3.93	3.60	4.06	3.91	3.75	4.06	3.95
June.....	3.75	3.75	3.75	3.66	3.99½	3.86	3.66	3.95	3.84	3.71	3.99½	3.88
Jan.-June.....	3.75	4.25	3.83	3.45½	4.34	3.96	3.50	4.32½	3.88	3.46	4.36	3.91
July.....	3.75	3.75	3.75	3.67½	4.70	4.40	3.88½	4.67	4.36	3.89	4.73	4.33
August.....	3.50	3.75	3.70	4.17	4.66½	4.39	4.21½	4.63	4.38	4.27	4.65	4.42
September.....	3.50	4.50	3.88	3.91	4.33	4.10	3.90	4.22½	4.09	3.90½	4.40	4.13
October.....	3.75	4.75	4.27	3.31	3.89½	3.61	3.33	3.87	3.60	3.31	3.91½	3.62
November.....	3.75	4.75	4.03	3.52	3.92	3.79	3.60	4.03½	3.83	3.51½	4.10	3.80
December.....	3.25	4.75	3.81	3.45½	3.64	3.53	3.41½	3.66	3.54	3.44	3.66	3.52
July-Dec.....	3.25	4.75	3.91	3.31	4.70	3.97	3.33	4.67	3.97	3.31	4.73	3.97

RICE.

TABLE 75.—Rice: Area and production in undermentioned countries, 1915–1917.

(Expressed in terms of hulled rice.)

Country.	Area.			Production.		
	1915	1916	1917	1915	1916	1917
<i>North America.</i>						
United States.....	<i>Acres.</i> 803,000	<i>Acres.</i> 869,000	<i>Acres.</i> 981,000	<i>Pounds.</i> 804,083,000	<i>Pounds.</i> 1,135,028,000	<i>Pounds.</i> 964,972,000
Hawaii ¹	9,000	(²)		25,820,000		
Porto Rico ¹	16,000					
<i>Central America:</i>						
Guatemala.....			29,000	24,015,000	13,744,000	20,733,000
Salvador.....	41,000			40,537,000		
Costa Rica.....	7,000					
Honduras.....						
Mexico.....		66,000		3,252,000	34,222,000	
<i>South America.</i>						
Argentina.....	8,000	17,000				
Brazil: Sao Paulo.....				79,380,000	153,235,000	204,327,000
British Guiana.....	47,000			91,630,000		
Dutch Guiana.....				6,913,000		
Peru.....				82,123,000	79,320,000	101,805,000
<i>Europe.</i>						
Bulgaria.....	8,000	9,000		8,889,000	16,000,000	
France.....	³ 1,000			³ 980,000		
Italy.....	356,000	353,000	341,000	762,900,000	708,058,000	716,359,000
Russia (northern Caucasias).....	⁴ 1,000			⁴ 729,000		
Spain.....	99,000	100,000	106,000	320,022,000	328,931,000	322,130,000
<i>Asia.</i>						
British India ⁵	78,152,000	80,080,000	79,698,000	73,525,760,000	77,931,840,000	80,516,800,000
Ceylon.....	785,000			⁶ 319,356,000		
Federated Malay States.....	³ 124,000			³ 87,321,000		
<i>Japanese Empire:</i>						
Japan.....	7,491,000	7,527,000	7,557,000	17,569,018,000	18,359,997,000	18,792,894,000
Formosa.....	1,214,000	1,166,000		1,503,101,000	1,460,563,000	
Korea.....	2,764,000			3,573,193,000	3,936,361,000	
Java and Madura.....	6,940,000	7,521,000		⁴ 7,826,026,000		
Philippine Islands.....	2,794,000	2,819,000		1,099,914,000	1,234,332,000	1,671,684,000
Russia: Transcaucasia and Turkestan ⁷	635,000			379,817,000		
Straits Settlements.....	⁸ 92,000	89,000				
Siam.....	5,181,000			5,517,167,000		
<i>Africa.</i>						
Egypt.....	331,000	150,000	273,000	542,439,000	236,528,000	487,163,000
Madagascar.....	1,198,000	1,176,000		1,023,012,000	1,017,470,000	
Nyasaland.....				1,606,000		
<i>Oceania.</i>						
Australia.....	(⁹)	(⁹)		⁴ 7,000	(¹⁰)	
Fiji.....	⁴ 12,000					

¹ Census of 1909.

² No official statistics.

³ Data for 1913.

⁴ Data for 1914.

⁵ Excluding a large area the production of which is not officially reported.

⁶ Excluding production of Matara, which in 1913 was 55,483,000 pounds.

⁷ Excluding Khiva and Bokhara.

⁸ Data for 1912.

⁹ Less than 500 acres.

¹⁰ Less than 500 pounds.

RICE—Continued.

TABLE 76.—Rice (cleaned): Total production in principal countries for which estimates are available, 1900–1915.

[The figures below include the principal countries for which estimates are available. The totals shown are merely approximate. China and French Indo-China are not included below. Three Provinces of China in 1910 produced 47,204,000,000 pounds of rice. The totals below may represent at least two-thirds of the total world production of rice.]

Year.	Production.	Year.	Production.	Year.	Production.
	<i>Pounds.</i>		<i>Pounds.</i>		<i>Pounds.</i>
1900.....	100,400,000,000	1906.....	105,800,000,000	1912.....	97,300,000,000
1901.....	94,400,000,000	1907.....	100,300,000,000	1913.....	100,700,000,000
1902.....	101,600,000,000	1908.....	102,900,000,000	1914.....	102,986,000,000
1903.....	101,800,000,000	1909.....	127,700,000,000	1915.....	115,193,190,000
1904.....	110,700,000,000	1910.....	128,100,000,000		
1905.....	102,400,000,000	1911.....	102,100,000,000		

TABLE 77.—Rice: Acreage, production, value, and condition, in the United States, 1904–1918.

Year.	Acreage.	Average yield per acre.	Production.	Average farm price per bushel Dec. 1.	Farm value Dec. 1.	Condition of growing crop.			
						July 1.	Aug. 1.	Sept. 1.	When harvested.
	<i>Acres.</i>	<i>Bushels.</i>	<i>Bushels.</i>	<i>Cents.</i>	<i>Dollars.</i>	<i>Per ct.</i>	<i>Per ct.</i>	<i>Per ct.</i>	<i>Per ct.</i>
1904.....	662,000	31.9	21,096,000	65.8	13,892,000	88.2	90.2	89.7	87.3
1905.....	482,000	28.2	13,607,000	95.2	12,956,000	88.0	92.9	92.2	89.3
1906.....	575,000	31.1	17,855,000	90.3	16,121,000	82.9	83.1	86.8	87.2
1907.....	627,000	29.9	18,738,000	85.8	16,081,000	88.7	88.6	87.0	88.7
1908.....	655,000	33.4	21,890,000	81.2	17,771,000	92.9	94.1	93.5	87.7
1909.....	720,000	33.8	24,368,000	79.6	17,383,000	90.7	84.5	84.7	81.2
1909.....	610,000	35.8	21,839,000	67.8	16,624,000	86.3	87.6	88.8	88.1
1910.....	723,000	33.9	24,510,000	79.7	18,274,000	87.7	88.3	87.2	85.4
1911.....	696,000	32.9	22,934,000	93.5	23,423,000	86.3	86.3	88.8	89.2
1912.....	723,000	34.7	25,054,000	85.8	22,090,000	88.4	88.7	88.0	80.3
1913.....	827,000	31.1	25,744,000	92.4	21,849,000	86.5	87.6	88.9	88.0
1914.....	694,000	34.1	23,649,000	90.6	26,212,000	90.5	90.0	82.3	80.9
1915.....	803,000	36.1	28,947,000	88.9	36,311,000	92.7	92.2	91.2	91.5
1916.....	869,000	47.0	40,861,000	189.6	65,879,000	85.1	85.0	78.4	79.7
1917.....	981,000	35.4	34,739,000	191.7	77,474,000	91.1	85.7	83.7	85.4
1918.....	1,113,000	36.3	40,424,000						

TABLE 78.—Rice: Acreage, production, and farm value, by States, 1918.

State.	Acreage.	Average yield per acre.	Production.	Average farm price per bushel Dec. 1.	Farm value Dec. 1.
	<i>Acres.</i>	<i>Bushels.</i>	<i>Bushels.</i>	<i>Dollars.</i>	<i>Dollars.</i>
North Carolina.....	500	20.0	10,000	2.00	20,000
South Carolina.....	4,500	23.0	104,000	1.95	203,000
Georgia.....	1,200	26.0	31,000	1.75	54,000
Florida.....	1,200	24.0	29,000	1.40	41,000
Missouri.....	550	45.0	25,000	1.80	45,000
Alabama.....	600	25.0	15,000	1.50	22,000
Mississippi.....	3,000	23.0	69,000	1.50	104,000
Louisiana.....	580,000	31.0	17,980,000	1.95	35,061,000
Texas.....	245,000	32.0	7,840,000	1.97	15,445,000
Arkansas.....	170,000	43.0	7,310,000	1.80	13,158,000
California.....	106,220	66.0	7,011,000	1.90	13,321,000
United States.....	1,112,770	36.3	40,424,000	1.92	77,474,000

RICE—Continued.

TABLE 79.—Rice: Yield per acre, price per bushel Dec. 1, and value per acre, by States.

State.	Yield per acre (bushels).										Farm price per bushel (cents).					Value per acre (dollars). ¹			
	10-year average, 1909-1918.	1909	1910	1911	1912	1913	1914	1915	1916	1917	1918	10-year average, 1909-1918.	1914	1915	1916	1917	1918	5-year average, 1914-1918.	1918
N. C.	24.6	30.2	26.5	25.6	25.0	24.0	26.3	21.0	21.0	26.0	20.0	105	75	85	85	195	200	29.22	40.00
S. C.	22.6	25.6	21.0	11.7	25.0	30.0	26.0	24.3	14.0	25.0	23.0	109	92	90	90	195	195	30.40	44.85
Ga.	26.8	23.9	22.0	26.8	30.0	32.0	28.0	29.3	20.0	30.0	26.0	105	89	88	87	195	175	34.42	45.50
Fla.	24.6	25.0	21.0	25.0	25.0	25.0	25.0	25.0	25.0	26.0	24.0	93	70	75	75	195	140	27.86	33.60
Mo.	47.8	50.0	51.0	45.0	45.0	142	100	100	190	180	66.88	81.00
Ala.	26.2	35.0	25.0	20.0	30.0	22.0	28.0	25.0	25.0	27.0	25.0	93	70	75	75	190	159	29.18	37.50
Mis.	29.5	30.0	30.0	36.0	35.0	28.0	30.0	25.0	28.0	30.0	23.0	98	85	88	80	190	150	32.28	34.50
La.	33.6	33.8	34.4	31.5	33.5	29.0	32.1	34.2	46.0	31.0	31.0	106	93	90	90	190	195	44.28	60.45
Tex.	34.0	34.0	33.0	34.3	35.5	32.0	33.8	30.5	45.0	30.0	32.0	107	92	89	86	200	197	44.00	63.04
Ark.	41.5	40.0	40.0	39.0	37.5	36.0	39.8	48.4	50.5	41.0	43.0	108	90	95	96	190	180	57.12	77.40
Calif.	53.8	33.0	40.0	50.0	48.0	53.3	66.7	59.0	68.0	66.0	107	100	90	78	175	190	80.75	125.40
U. S.	35.5	33.8	33.9	32.9	34.7	31.1	34.1	36.1	47.0	35.4	36.3	105.9	92.4	90.6	88.9	189.6	191.7	48.54	69.62

¹ Based upon farm price Dec. 1.

TABLE 80.—Rice: Wholesale price per pound, 1913-1918.

Date.	New York.			Cincinnati.			Lake Charles.			New Orleans.			Houston.		
	Domestic (good).			Prime.			Rough, per 162 pounds.			Honduras, cleaned.			Head rice, cleaned.		
	Low.	High.	Average.	Low.	High.	Average.	Low.	High.	Average.	Low.	High.	Average.	Low.	High.	Average.
1913.															
Jan.-June	Cts. 4 3/4	Cts. 5	Cts. 5 1/2	Cts. 6 1/4	Dols. 2.50	Dols. 3.82	Cts. 2 3/4	Cts. 5 3/8	Cts. 4 1/2	Cts. 5 1/2
July-Dec.	4 3/4	5 1/4	5 3/4	6 1/4	2.00	3.76	1.15	7	4 1/2	5 1/2
1914.															
Jan.-June	4 3/4	5	5 3/4	6 1/4	1.40	3.76	1 1/2	6 1/8	3 3/8	5 1/4
July-Dec.	4 3/4	5 3/8	5 3/4	6 1/4	2.00	4.55	1 1/2	6 3/8	3	5 1/2
1915.															
Jan.-June	5	5 1/2	5 3/4	6 1/2	2.85	4.61 1/2	2 1/2	5 1/2	4 1/2	5
July-Dec.	4 1/2	5 1/2	5	6 1/2	2.80	3.65	2	5 1/2	4 1/2	5 3/8
1916.															
Jan.-June	5	5 1/2	5 1/2	5 3/4	2.65	4.25	2	5 1/2	3 3/4	4 3/4
July-Dec.	5	5 1/2	5 1/2	5 1/2	2.60	3.65	2 1/2	5 1/2	3 1/2	4 1/2
1917.															
January	5 1/2	5 1/2	5 1/2	5 3/4	2.70	3.40	2 1/2	5 1/2	4 3/4	5
February	5 1/2	5 1/2	5 1/2	5 3/4	3.00	3.75	2 1/2	5 1/2	4 3/4	5 1/2
March	5 1/2	5 1/2	5 1/2	5 3/4	3.20	4.25	2 1/2	5 3/8	4 3/4	5 1/2
April	5 1/2	5 1/2	5 1/2	5 3/4	3.60	6.21	2 1/2	7 1/8	5	8
May	8 3/4	9	8 3/4	8 1/2	4.10	7.00	3 3/8	8 1/2	7 3/4	8
June	8 1/2	9	8 1/2	8 1/2	4 3/8	8 1/2	7 1/2	8 1/2
Jan.-June	5 1/2	9	5 1/2	8 1/2	2.70	7.00	2 1/2	8 1/2	4 3/4	8
July	8	8 3/4	8	8 1/2	5.50	6.00	4 3/4	8 1/2	7 1/2	7 3/4
August	7 3/8	8 1/2	8	8 3/8	5.50	6.68	4 1/2	7 3/8	7	7 1/2
September	7 3/8	8 1/2	8	8 3/8	5.50	6.50	4 1/2	8 1/2	7	7 1/2
October	7 3/8	9	8 1/2	8 3/8	5.93	7.50	5	8 3/8	7 3/8	8
November	8 3/8	9 1/2	8 1/2	8 3/8	5.65	7.38	5	8 1/2	7 3/8	8 1/2
December	8 3/8	9	8 1/2	8 3/8	5.34	7.20	5 1/2	8 3/8	7 3/8	8 1/2
July-Dec.	7 3/8	9 1/2	8	8 3/4	5.34	7.50	4 3/4	8 1/2	7	8 1/2

RICE—Continued.

TABLE 80.—Rice: Wholesale price per pound, 1913–1918—Continued.

Date.	New York.			Cincinnati.			Lake Charles.			New Orleans.			Houston.		
	Domestic (good).			Prime.			Rough, per 162 pounds.			Honduras, cleaned.			Head rice, cleaned.		
	Low.	High.	Average.	Low.	High.	Average.	Low.	High.	Average.	Low.	High.	Average.	Low.	High.	Average.
1918.															
January.....	Cts. 8½	Cts. 9	Cts. 8.9	Cts. 8½	Cts. 8½	Cts. 8.6	Dols.	Dols.	Dols.	Cts. 5½	Cts. 5½	Cts. 6.8	Cts.	Cts.	Cts.
February.....	8½	9½	8.9	8½	8½	8.6	5½	5½	7.0
March.....	9½	9½	9.4	8½	9½	8.9	6	9½	7.6
April.....	9½	10	9.6	9	9½	9.3	6½	9½	8.2
May.....	9½	10	9.9	9½	9½	9.4	7	9½	8.3
June.....	9½	10½	10.0	9½	10	9.4	7	9½	8.3
Jan.-June....	8½	10½	9.4	8½	10	9.0	5½	9½	7.7
July.....	10	10½	10.1	10	10	10.0	7	10½	8.4
August.....	10	10½	10.1	10	10	10.0	6½	9½	7.6
September....	10	10½	10.1	10	10	10.0	5½	9½	7.6
October.....	10	10½	10.2	10	10½	10.2	5½	9½	7.5
November....	9½	10½	10.5	10	10½	10.2	4½	9½	7.3
December....	10½	10½	10.5	10	10½	10.2	5	9½	7.5
July-Dec....	9½	10½	10.2	10	10½	10.1	4½	10½	7.6

TABLE 81.—Rice: International trade, calendar years 1909–13, 1916–17.

[Mostly cleaned rice. Under rice is included paddy, unhulled, rough, cleaned, polished, broken, and cargo rice, in addition to rice flour and meal. Rice bran is not included. Rough rice or paddy, where specifically reported, has been reduced to terms of cleaned rice at ratio of 162 pounds rough or unhulled to 100 pounds cleaned. "Rice, other than whole or cleaned rice," in the returns of United Kingdom is not considered paddy, since the chief sources of supply indicate that it is practically all hulled rice. Cargo rice, a mixture of hulled and unhulled, is included without being reduced to terms of cleaned. Broken rice and rice flour and meal are taken without being reduced to terms of whole cleaned rice. See "General note," Table 11.]

EXPORTS.

[000 omitted.]

Country.	Average, 1909–1913	1916 (prelim.)	1917 (prelim.)	Country.	Average, 1909–1913	1916 (prelim.)	1917 (prelim.)
FROM—	Pounds.	Pounds.	Pounds.	FROM—	Pounds.	Pounds.	Pounds.
Belgium.....	99,948	Penang.....	357,548
British India.....	5,337,516	Siam.....	1,928,507	2,627,250
Dutch East Indies.....	132,400	Singapore.....	753,875
France.....	79,087	41,875	Other countries.....	866,020
French Indo-China.....	2,283,040	Total.....	12,720,845
Germany.....	396,628				
Netherlands.....	476,276	9,127				

IMPORTS.

INTO—				INTO—			
Austria-Hungary...	183,411	Netherlands.....	778,682	144,254
Belgium.....	180,830	Penang.....	511,035
Brazil.....	24,753	1,575	Perak.....	179,187
British India.....	278,272	Philippine Islands.....	412,781	418,512	324,045
Ceylon.....	821,654	Russia.....	250,461	166,779
China.....	704,992	1,504,536	1,311,624	Selangor.....	159,178
Cuba.....	262,207	Singapore.....	975,095
Dutch East Indies.....	1,178,111	United Kingdom.....	768,853	988,577
Egypt.....	98,690	17,368	United States.....	209,814	215,712	266,471
France.....	517,861	501,923	Other countries.....	1,242,092
Germany.....	913,772	Total.....	11,439,950
Japan.....	655,676	63,613				
Mauritius.....	132,543				

STATISTICS OF CROPS OTHER THAN GRAIN CROPS.

POTATOES.

TABLE 82.—Potatoes: Area and production of undermentioned countries, 1915–1917.

Country.	Area.			Production.		
	1915	1916	1917	1915	1916	1917
NORTH AMERICA.						
United States.....	3,734,000	3,565,000	4,374,000	359,721,000	286,953,000	438,618,000
Canada:						
Prince Edward Island....	31,000	31,000	35,000	3,558,000	6,386,000	6,125,000
Nova Scotia.....	34,000	34,000	41,000	4,759,000	6,935,000	7,173,000
New Brunswick.....	40,000	39,000	46,000	5,772,000	7,488,000	6,891,000
Quebec.....	117,000	112,000	227,000	17,510,000	14,672,000	18,158,000
Ontario.....	155,000	133,000	142,000	14,362,000	8,113,000	18,981,000
Manitoba.....	30,000	32,000	34,000	2,565,000	4,709,000	3,643,000
Saskatchewan.....	35,000	47,000	68,000	3,847,000	7,319,000	9,010,000
Alberta.....	28,000	29,000	49,000	4,024,000	4,783,000	7,409,000
British Columbia.....	16,000	15,000	15,000	3,956,000	2,892,000	2,502,000
Total Canada.....	486,000	473,000	657,000	60,353,000	63,297,000	79,892,000
Mexico.....	(1)			2 623,000		
Newfoundland.....		(1)		3 1,524,000	(1)	
Total.....				422,221,000		
SOUTH AMERICA.						
Argentina.....	306,000	322,000		29,597,000	31,138,000	
Chile.....	78,000	79,000		9,546,000	11,598,000	
Total.....	384,000			39,143,000	42,736,000	
EUROPE.						
Austria-Hungary:						
Austria 4.....	1,757,000			232,203,000		
Hungary proper.....	1,577,000			209,356,000		
Croatia-Slavonia.....	5 194,000			6 21,140,000		
Bosnia-Herzegovina.....	5 67,000			5 2,998,000		
Total Austria-Hungary..	3,595,000			465,697,000		
Belgium.....	5 395,000			5 117,613,000		
Bulgaria.....	3 8,000			3 503,000		
Denmark.....	160,000	159,000	143,000	42,349,000	26,629,000	31,882,000
Finland.....	6 181,000			7 18,736,000		
France.....	3,223,000	3,222,000	3,482,000	332,788,000	335,507,000	401,336,000
Germany.....	8,827,000			1,983,161,000	882,000,000	
Italy.....	725,000	729,000	732,000	56,768,000	54,277,000	48,112,000
Luxemburg.....	36,000	34,000	27,000	6,422,000	2,971,000	5,925,000
Malta.....	3,000	3,000		568,000	356,000	
Netherlands.....	438,000	413,000	419,000	126,741,000	88,490,000	89,858,000
Norway.....	113,000	114,000	145,000	19,957,000	31,310,000	42,584,000
Roumania 8.....	28,000	35,000		3,765,000		
Do 9.....	52,000			865,000		
Russia, European:						
Russia proper.....	6,815,000	5,879,000		770,709,000	662,169,000	
Poland.....	5 2,662,000			5 383,736,000		
Northern Caucasia.....	165,000			15,796,000		
Total European Russia..	9,642,000			1,170,241,000		
Serbia.....	3 31,000			3 2,173,000		
Spain.....	7 688,000		839,000	7 76,657,000		113,477,000
Sweden.....	382,000	373,000	397,000	71,756,000	54,972,000	83,700,000
Switzerland.....	159,000	200,000	140,000	30,681,000	18,372,000	38,580,000
United Kingdom:						
England.....	437,000	400,000	473,000	100,881,000	88,484,000	117,351,000
Scotland.....	144,000	130,000	148,000	36,291,000	19,825,000	41,443,000
Wales.....	26,000	28,000	35,000	5,821,000	5,018,000	7,380,000
Ireland.....	594,000	586,000	709,000	138,509,000	90,845,000	155,036,000
Total United Kingdom..	1,201,000	1,144,000	1,365,000	281,502,000	204,172,000	321,209,000
Total.....				4,808,943,000		

1 No official statistics.

2 Data for 1907.

3 Data for 1912.

4 Galicia and Bukowina not included.

5 Data for 1913.

6 Data for 1910.

7 Data for 1914.

8 Grown alone.

9 Grown with corn.

POTATOES—Continued.

TABLE 82.—Potatoes: Area and production of undermentioned countries, 1915–1917—Con.

Country.	Area.			Production.		
	1915	1916	1917	1915	1916	1917
ASIA.	<i>Acres.</i>	<i>Acres.</i>	<i>Acres.</i>	<i>Bushels.</i>	<i>Bushels.</i>	<i>Bushels.</i>
Japan.....	225,000	254,000	246,000	35,103,000	38,613,000	36,924,000
Russia, Asiatic:						
Central Asia (4 govern- ments of).....	106,000			7,974,000		
Siberia (4 governments of) Transcaucasia (1 govern- ment of).....	296,000			24,307,000		
	2,000			100,000		
Total Asiatic Russia.....	404,000			32,381,000		
Total.....				67,484,000		
AFRICA.						
Algeria.....	148,000		27,000	12,119,000		2,756,000
Union of South Africa.....	262,000			3,685,000		
Total.....				5,804,000		
AUSTRALASIA.						
Australia:						
Queensland.....	8,000	6,000	9,000	598,000	278,000	726,000
New South Wales.....	30,000	20,000	22,000	1,520,000	1,658,000	1,691,000
Victoria.....	65,000	57,000	74,000	7,064,000	6,489,000	7,018,000
South Australia.....	8,000	4,000	5,000	673,000	485,000	759,000
Western Australia.....	5,000	5,000	6,000	550,000	527,000	629,000
Tasmania.....	32,000	29,000	34,000	2,946,000	2,983,000	2,503,000
Total Australia.....	148,000	121,000	150,000	13,351,000	12,421,000	13,326,000
New Zealand.....	22,000	30,000	26,000	4,952,000	4,809,000	4,992,000
Total Australasia.....	170,000	151,000	176,000	18,303,000	17,230,000	18,318,000
Grand total.....				5,361,898,000		

¹ Data for 1913.² Census of 1911.

TABLE 83.—Potatoes: Total production of countries mentioned in Table 82, 1900–1915.

Year.	Production.	Year.	Production.	Year.	Production.	Year.	Production.
	<i>Bushels.</i>		<i>Bushels.</i>		<i>Bushels.</i>		<i>Bushels.</i>
1900.....	4,382,031,000	1904.....	4,298,049,000	1908.....	5,295,043,000	1912.....	5,872,953,000
1901.....	4,669,958,000	1905.....	5,254,598,000	1909.....	5,595,567,000	1913.....	5,802,910,000
1902.....	4,674,000,000	1906.....	4,789,112,000	1910.....	5,242,278,000	1914.....	5,016,291,000
1903.....	4,408,793,000	1907.....	5,122,078,000	1911.....	4,842,109,000	1915.....	5,361,898,000

TABLE 84.—Potatoes: Average yield, per acre, of undermentioned countries in 1900–1918.

Year.	United States.	Russia (Euro- pean). ¹	Ger- many. ¹	Austria. ¹	Hungary proper. ¹	France. ¹	United King- dom. ¹
Average:	<i>Bushels.</i>	<i>Bushels.</i>	<i>Bushels.</i>	<i>Bushels.</i>	<i>Bushels.</i>	<i>Bushels.</i>	<i>Bushels.</i>
1900–1909.....	91.4	99.9	200.0	151.1	118.7	133.8	193.8
1910–1915.....	97.6	107.9	205.7	145.6	122.2	116.3	222.8
1906.....	102.2	94.9	193.3	158.4	128.7	99.5	192.2
1907.....	95.4	102.4	205.3	173.2	126.6	136.2	171.0
1908.....	85.7	102.9	209.2	154.0	96.6	163.7	231.1
1909.....	106.8	111.5	208.9	157.3	125.2	160.3	222.1
1910.....	93.8	121.1	196.1	160.0	117.4	81.9	209.1
1911.....	80.9	104.2	153.9	137.2	106.3	121.8	241.5
1912.....	113.4	121.5	223.5	149.0	129.2	142.9	177.0
1913.....	90.4	110.6	235.8	134.7	118.4	127.3	242.0
1914.....	110.5	102.8	200.1	160.7	129.0	119.9	233.3
1915.....	96.3	87.1	224.7	132.1	132.8	103.9	234.1
1916.....	80.4					104.1	178.5
1917.....	100.8					115.2	235.2
1918.....	95.0						

¹ Bushels of 60 pounds.

POTATOES—Continued.

TABLE 85.—Potatoes: Acreage, production, value, exports, etc., in the United States, 1849—1918.

NOTE.—Figures in *italics* are census returns; figures in roman are estimates of the Department of Agriculture. Estimates of acres are obtained by applying estimated percentages of increase or decrease to the published numbers of the preceding year, except that a revised base is used for applying percentage estimates whenever new census data are available.

Year.	Acreage.	Average yield per acre.	Production.	Average farm price per bushel Dec. 1.	Farm value Dec. 1.	Chicago cash price per bushel, fair to fancy. ¹				Domestic exports, fiscal year beginning July 1.	Imports during fiscal year beginning July 1.
						December.		Following May.			
						Low.	High.	Low.	High.		
1849			<i>65,798,000</i>							155,595	
1859			<i>111,149,000</i>							380,372	
1866	1,069,000	100.2	107,201,000	47.3	50,723,000					512,380	198,265
1867	1,192,000	82.0	97,783,000	65.9	64,462,000					378,605	209,555
1868	1,132,000	93.8	106,090,000	59.3	62,919,000					508,249	138,470
1869	1,222,000	109.5	133,886,000	42.9	57,481,000					596,968	75,336
1869			<i>143,337,000</i>								
1870	1,325,000	86.6	114,775,000	65.0	74,621,000					553,070	458,758
1871	1,221,000	98.7	120,462,000	53.9	64,905,000					621,537	96,259
1872	1,331,000	85.3	113,516,000	53.5	60,692,000					515,306	346,840
1873	1,295,000	81.9	106,089,000	65.2	69,154,000					497,413	549,073
1874	1,310,000	80.9	105,981,000	61.5	65,223,000					609,642	188,757
1875	1,510,000	110.5	166,877,000	34.4	57,358,000					704,379	92,148
1876	1,742,000	71.7	124,827,000	61.9	77,320,000					529,650	3,205,555
1877	1,792,000	94.9	170,092,000	43.7	74,272,000					744,409	528,584
1878	1,777,000	69.9	124,127,000	58.7	72,924,000					625,342	2,624,149
1879	1,837,000	98.9	181,626,000	43.6	79,154,000					696,080	721,868
1879			<i>169,459,000</i>								
1880	1,843,000	91.0	167,660,000	48.3	81,062,000					638,840	2,170,372
1881	2,042,000	53.5	109,145,000	91.0	99,291,000					408,286	8,789,860
1882	2,172,000	78.7	170,973,000	55.7	95,305,000					439,443	2,362,362
1883	2,289,000	90.9	208,164,000	42.2	87,849,000					554,613	425,408
1884	2,221,000	85.8	190,642,000	39.6	75,524,000					380,868	658,633
1885	2,266,000	77.2	175,029,000	44.7	78,153,000			33	50	494,948	1,937,416
1886	2,287,000	73.5	168,051,000	46.7	78,442,000	44	47	65	90	434,864	1,432,490
1887	2,357,000	56.9	134,103,000	68.2	91,507,000	70	83	65	85	403,880	8,259,538
1888	2,533,000	79.9	202,365,000	40.2	81,414,000	30	37	24	45	471,955	883,380
1889	2,648,000	77.4	204,881,000	35.4	72,611,000	33	45	30	60	406,618	3,415,578
1889			<i>217,546,000</i>								
1890	2,652,000	55.9	148,290,000	75.8	112,342,000	82	93	95	110	341,189	5,401,912
1891	2,715,000	93.7	254,424,000	35.8	91,013,000	30	40	30	50	557,022	186,871
1892	2,548,000	61.5	156,655,000	66.1	103,568,000	60	72	70	98	845,720	4,317,021
1893	2,605,000	70.3	183,034,000	59.4	108,662,000	51	60	64	88	803,111	3,002,578
1894	2,738,000	62.4	170,787,000	53.6	91,527,000	43	58	40	70	572,957	1,341,533
1895	2,955,000	100.6	297,237,000	26.6	78,985,000	18	24	10	23	680,049	175,240
1896	2,767,000	91.1	252,235,000	28.6	72,182,000	18	26	19	26	926,646	246,178
1897	2,535,000	64.7	164,016,000	54.7	89,643,000	50	62	60	87	605,187	1,171,378
1898	2,558,000	75.2	192,306,000	41.4	79,575,000	30	36	33	52	579,833	530,420
1899	2,581,000	88.6	228,783,000	39.0	89,329,000	35	46	27	39	809,472	155,861
1899			<i>273,318,000</i>								
1900	2,611,000	80.8	210,927,000	43.1	90,811,000	40	48	35	60	741,483	371,911
1901	2,804,000	65.5	187,598,000	76.7	143,979,000	75	82	58	100	528,484	7,656,162
1902	2,966,000	96.0	284,633,000	47.1	134,111,000	42	48	42	60	843,075	358,505
1903	2,917,000	84.7	247,128,000	61.4	151,638,000	60	66	95	116	484,042	3,161,581
1904	3,016,000	110.4	332,830,000	45.3	150,673,000	32	38	20	25	1,163,270	186,199
1905	2,997,000	87.0	260,741,000	61.7	160,821,000	55	66	48	73	1,000,326	1,948,160
1906	3,013,000	102.2	308,038,000	51.1	157,547,000	40	43	55	75	1,530,461	176,917
1907	3,128,000	95.4	298,262,000	61.8	184,184,000	46	58	50	80	1,203,894	403,952
1908	3,257,000	85.7	278,985,000	70.6	197,039,000	60	77	70	150	763,651	8,383,966
1909	3,525,000	106.8	376,537,000								
1909			<i>389,195,000</i>								
1910	3,720,000	93.8	349,032,000	55.7	194,566,000	20	58	16	34	999,476	353,208
1911	3,619,000	80.9	292,737,000	79.9	233,778,000	30	48	35	75	2,383,887	218,984
1912	3,711,000	113.4	420,647,000	50.5	212,550,000	40	65	33	70	2,028,261	13,734,095
1913	3,668,000	90.4	331,525,000	68.7	227,903,000	50	70	60	90	1,794,073	337,230
1914	3,711,000	110.5	409,921,000	48.7	199,460,000	30	66	34	150	3,135,474	270,942
1915	3,734,000	96.3	359,721,000	61.7	221,992,000	53	95	80	110	4,017,760	209,532
1916	3,565,000	80.5	286,953,000	146.1	419,333,000	125	190	200	375	2,489,001	3,679,025
1917	4,384,000	100.8	442,108,000	122.8	542,774,000	93	135	80	250	3,453,307	1,180,480
1918	4,210,000	95.0	400,106,000	119.5	478,136,000	30	225				

¹ Burbank to 1910.

² Figures adjusted to census basis.

³ Per 100 pounds.

POTATOES—Continued.

TABLE 86.—Potatoes: Revised acreage, production, and farm value, 1889–1909.

NOTE.—This revision consists (1) in using the Department of Agriculture's estimate of average yield per acre to compute, from census acreage, the total production, (2) in adjusting the department's estimate of acreage for each year so as to be consistent with the following as well as the preceding census acreage, and (3) in recomputing total farm value from these revised production figures.

Year.	Acreage.	Average yield per acre.	Production.	Average farm price per bushel Dec. 1.	Farm value Dec. 1.
	<i>Acres.</i>	<i>Bushels.</i>	<i>Bushels.</i>	<i>Cents.</i>	<i>Dollars.</i>
1889.....	2,601,000	77.4	201,200,000	35.4	71,294,000
1890.....	2,653,000	56.7	150,494,000	75.3	113,291,000
1891.....	2,732,000	93.7	256,122,000	35.6	91,229,000
1892.....	2,650,000	62.1	164,516,000	65.5	107,835,000
1893.....	2,722,000	71.7	195,040,000	58.4	113,886,000
1894.....	2,891,000	63.6	183,841,000	52.8	97,030,000
1895.....	3,101,000	102.3	371,114,000	26.2	85,151,000
1896.....	2,975,000	91.4	271,769,000	29.0	78,783,000
1897.....	2,813,000	67.9	191,025,000	54.2	103,442,000
1898.....	2,841,000	77.0	218,772,000	41.5	90,897,000
1899.....	2,939,000	88.6	260,257,000	39.7	103,365,000
1900.....	2,987,000	82.9	247,759,000	42.3	104,764,000
1901.....	2,996,000	66.3	198,626,000	76.3	151,602,000
1902.....	3,078,000	95.5	293,918,000	46.9	137,730,000
1903.....	3,080,000	85.1	262,053,000	60.9	159,620,000
1904.....	3,172,000	111.1	352,268,000	44.8	157,646,000
1905.....	3,195,000	87.3	278,885,000	61.1	170,340,000
1906.....	3,244,000	102.2	331,685,000	50.6	167,795,000
1907.....	3,375,000	95.7	322,954,000	61.3	197,863,000
1908.....	3,503,000	86.2	302,000,000	69.7	210,618,000
1909.....	3,669,000	107.5	394,553,000	54.2	213,679,000

TABLE 87.—Potatoes: Acreage, production, and total farm value, by States, 1918.

[000 omitted.]

State.	Acreage.	Production.	Farm value Dec. 1.	State.	Acreage.	Production.	Farm value Dec. 1.
	<i>Acres.</i>	<i>Bushels.</i>	<i>Dollars.</i>		<i>Acres.</i>	<i>Bushels.</i>	<i>Dollars.</i>
Maine.....	112	22,400	26,880	North Dakota.....	90	8,910	6,504
New Hampshire.....	21	2,940	4,263	South Dakota.....	90	8,190	7,617
Vermont.....	26	3,380	4,664	Nebraska.....	121	10,406	12,279
Massachusetts.....	36	4,788	8,140	Kansas.....	80	4,240	6,106
Rhode Island.....	5	650	1,124	Kentucky.....	75	5,625	9,281
Connecticut.....	26	2,470	4,076	Tennessee.....	50	3,500	5,775
New York.....	380	34,960	42,651	Alabama.....	60	4,800	8,688
New Jersey.....	92	8,464	14,389	Mississippi.....	20	1,600	2,640
Pennsylvania.....	305	24,400	36,844	Louisiana.....	55	4,345	6,518
Delaware.....	11	957	1,340	Texas.....	60	3,300	6,600
Maryland.....	50	4,000	4,800	Oklahoma.....	37	1,258	2,453
Virginia.....	125	11,750	14,100	Arkansas.....	48	2,400	4,416
West Virginia.....	60	5,220	8,352	Montana.....	52	7,020	5,616
North Carolina.....	45	4,275	5,771	Wyoming.....	30	4,500	3,825
South Carolina.....	28	2,856	5,512	Colorado.....	72	11,376	11,262
Georgia.....	23	1,610	2,978	New Mexico.....	10	1,000	1,600
Florida.....	35	3,500	7,000	Arizona.....	5	425	871
Ohio.....	160	11,040	16,560	Utah.....	20	3,600	3,492
Indiana.....	97	7,760	10,476	Nevada.....	9	1,539	1,893
Illinois.....	160	11,520	17,050	Idaho.....	29	5,220	4,228
Michigan.....	340	28,560	25,418	Washington.....	65	8,580	8,666
Wisconsin.....	295	33,040	26,432	Oregon.....	50	5,500	5,600
Minnesota.....	312	32,760	24,570	California.....	90	12,870	15,444
Iowa.....	134	9,648	12,832				
Missouri.....	114	6,954	10,640	United States..	4,210	400,106	478,136

POTATOES—Continued.

TABLE 88.—Potatoes: Condition of crop, United States, on 1st of months named, 1897-1918.

Year.	Year.				Year.	Year.			
	July.	Aug.	Sept.	Oct.		July.	Aug.	Sept.	Oct.
	<i>P. ct.</i>	<i>P. ct.</i>	<i>P. ct.</i>	<i>P. ct.</i>		<i>P. ct.</i>	<i>P. ct.</i>	<i>P. ct.</i>	<i>P. ct.</i>
1897.....	87.8	77.9	66.7	61.6	1908.....	89.6	82.9	73.7	68.7
1898.....	95.5	83.9	77.7	72.5	1909.....	93.0	85.8	80.9	78.8
1899.....	93.8	93.0	86.3	81.7	1910.....	86.3	75.8	70.5	71.8
1900.....	91.3	88.2	80.0	74.4	1911.....	76.0	62.3	59.8	62.3
1901.....	87.4	62.3	52.2	54.0	1912.....	88.9	87.8	87.2	85.1
1902.....	92.9	94.8	89.1	82.5	1913.....	86.2	78.0	69.9	67.7
1903.....	88.1	87.2	84.3	74.6	1914.....	83.6	79.0	75.8	78.3
1904.....	93.9	94.1	91.6	89.5	1915.....	91.1	92.0	82.7	74.2
1905.....	91.2	87.2	80.9	74.3	1916.....	87.8	80.8	67.4	62.6
1906.....	91.5	89.0	85.3	82.2	1917.....	90.1	89.0	82.7	79.0
1907.....	90.2	88.5	80.2	77.0	1918.....	87.6	79.9	74.5	73.7

TABLE 89.—Potatoes: Yield per acre, price per bushel Dec. 1, and value per acre, by States.

State.	Yield per acre (bushels).										Farm price per bushel (cents).					Value per acre (dollars). ¹			
	10-year aver- age, 1909-1918.										10-year aver- age, 1909-1918.					5-year aver- age, 1914-1918.			
	1909	1910	1911	1912	1913	1914	1915	1916	1917	1918	1914	1915	1916	1917	1918	1918	1918		
Me.....	201	225	220	180	198	220	260	179	200	125	200	77	33	70	142	130	120	180.66	240.00
N. H.....	129	130	150	125	140	122	159	95	120	107	140	98	60	95	166	167	145	153.31	203.00
Vt.....	123	155	130	105	140	127	168	108	112	100	130	84	47	81	139	140	138	128.30	179.40
Mass.....	119	125	125	93	130	105	155	120	91	115	133	109	71	94	175	175	170	161.89	226.10
R. I.....	123	125	136	110	113	130	165	110	74	135	130	112	70	92	185	175	173	162.95	224.90
Conn.....	106	120	125	85	107	92	140	95	95	110	95	109	65	96	175	164	165	137.12	156.75
N. Y.....	94	120	102	74	106	74	145	62	70	95	92	86	44	82	158	130	122	92.20	112.24
N. J.....	104	90	105	73	108	95	108	130	122	114	92	100	61	75	155	141	170	133.92	156.40
Pa.....	84	78	88	56	109	88	105	72	70	92	80	91	58	75	148	135	151	92.70	120.80
Del.....	89	96	103	60	100	87	80	95	90	95	87	91	70	75	125	130	140	97.01	121.80
Md.....	87	80	95	45	112	87	78	97	95	100	80	83	60	62	133	119	120	89.66	96.00
Va.....	93	92	98	45	87	94	65	125	130	99	94	89	77	61	137	125	120	108.19	112.80
W. Va.....	89	98	92	45	112	83	54	117	88	115	87	99	81	65	158	132	160	109.97	139.20
N. C.....	80	74	89	48	85	80	52	90	95	90	95	100	92	73	140	143	135	100.70	128.25
S. C.....	84	85	90	70	90	80	70	80	75	96	102	140	125	115	175	210	193	141.84	196.86
Ga.....	73	81	82	72	78	81	60	65	60	84	70	127	105	99	175	195	185	105.13	129.50
Fla.....	87	95	90	90	93	76	80	80	74	91	100	142	113	115	200	205	200	143.39	200.00
Ohio.....	81	93	82	65	112	64	95	82	45	100	69	93	53	70	182	143	150	87.23	103.50
Ind.....	80	95	84	58	114	53	80	95	44	92	80	89	56	56	177	139	135	82.35	108.00
Ill.....	75	91	75	50	101	46	60	110	58	90	72	96	61	59	179	152	148	89.74	106.56
Mich.....	91	105	105	94	105	96	121	59	48	95	84	67	30	56	160	105	89	64.12	74.76
Wis.....	103	102	95	116	120	109	124	87	47	114	112	62	30	45	147	90	80	67.53	89.60
Minn.....	103	115	61	115	135	110	114	106	60	112	105	60	32	39	130	91	75	67.30	78.75
Iowa.....	79	89	72	74	109	48	86	105	42	95	72	87	59	54	175	131	133	80.23	95.76
Mo.....	67	85	86	27	84	38	45	98	60	87	61	100	73	60	180	137	153	82.43	93.33
N. Dak..	92	110	41	120	128	85	109	90	93	43	99	68	42	41	115	130	73	63.56	72.27
S. Dak..	83	80	44	72	105	78	90	115	66	90	91	74	47	35	137	111	93	71.50	84.63
Nebr.....	75	78	60	52	80	48	80	105	73	85	86	84	54	42	150	107	118	77.85	101.48
Kans.....	61	79	57	22	82	40	62	83	71	57	53	105	77	74	165	152	144	77.85	76.32
Ky.....	80	92	92	39	101	49	45	126	84	96	75	99	84	55	142	140	165	96.91	123.75
Tenn.....	72	75	80	41	88	64	43	88	82	94	70	100	91	63	149	126	165	90.14	115.50
Ala.....	80	80	80	78	81	84	79	80	90	72	80	123	101	90	169	182	181	115.95	144.80
Miss.....	82	87	85	83	89	80	80	90	65	78	80	117	95	84	160	168	165	103.73	132.00
La.....	67	75	55	69	73	70	70	51	65	64	79	115	97	95	167	184	150	92.23	118.50
Tex.....	56	50	51	57	63	52	61	65	50	60	55	137	104	105	190	210	200	92.54	110.00
Okla.....	58	70	60	18	60	60	70	85	53	69	34	126	90	84	195	180	195	85.65	66.30
Ark.....	70	70	84	55	70	72	60	90	65	80	50	119	97	76	190	137	184	93.54	92.00
Mont.....	140	180	120	150	165	140	140	155	125	95	135	73	64	50	120	102	80	104.40	108.00
Wyo.....	128	160	100	42	140	140	108	150	130	155	150	86	70	60	128	104	85	124.14	127.50
Colo.....	122	160	100	35	95	115	120	135	138	160	158	75	50	55	135	91	99	124.51	156.42

¹ Based upon farm price Dec. 1.

POTATOES—Continued.

TABLE 89.—Potatoes: Yield per acre, price per bushel Dec. 1, and value per acre, by States—Continued.

State.	Yield per acre (bushels).										Farm price per bushel (cents).						Value per acre (dollars). ¹		
	10-year average, 1909-1918.	1909	1910	1911	1912	1913	1914	1915	1916	1917	1918	10-year average, 1909-1918.	1914	1915	1916	1917	1918	5-year average, 1914-1918.	1918
N. Mex..	90	85	47	80	100	68	100	100	102	116	100	120	95	95	175	165	160	143.98	160.00
Ariz.....	99	90	92	95	125	75	110	95	115	105	85	141	120	100	180	150	205	153.15	174.25
Utah.....	164	180	142	140	185	180	140	125	180	189	180	72	60	63	130	78	97	143.75	174.60
Nev.....	170	180	150	160	178	160	130	172	190	207	171	90	70	70	130	120	123	183.43	210.33
Idaho...	164	200	142	180	185	170	155	125	150	156	180	65	48	56	127	79	81	120.79	145.80
Wash.....	144	170	131	160	167	123	128	135	165	125	132	68	55	53	98	92	101	110.39	133.32
Oreg.....	126	160	105	130	155	135	97	115	150	108	110	68	60	60	90	80	100	91.72	110.00
Calif.....	134	130	130	135	130	113	138	130	141	145	143	94	70	75	140	150	120	156.12	171.60
U. S. . .	96.8	106.8	93.8	80.9	113.4	90.4	110.5	96.3	80.5	100.8	95.0	80.8	48.7	61.7	146.1	122.8	119.5	93.64	113.57

Based upon farm price Dec. 1.

TABLE 90.—Potatoes: Stocks on January 1.

State and year.	Total production (000 omitted).	Stocks Jan. 1.				Price per bushel—	
		Per cent of crop.	Bushels (000 omitted).	Per cent of stock held by—		Dec. 1.	Mar. 1.
				Growers.	Dealers.		
Total (21 Northern States):	<i>Bushels.</i>					<i>Cents.</i>	<i>Cents.</i>
1918-19.....	277,475	43.5	120,769	82.4	17.6	115
1917-18.....	303,899	49.6	150,666	84.6	15.4	122	116
1916-17.....	183,281	33.1	60,603	74.9	25.1	152	252
1915-16.....	254,235	43.6	110,810	79.5	20.5	60	93
Total (11 Far West States):							
1918-19.....	61,630	48.0	29,590	85.3	14.7	158
1917-18.....	70,779	42.0	32,748	86.8	13.2	105	88
1916-17.....	54,081	44.6	24,140	71.0	29.0	120	238
1915-16.....	48,776	53.5	26,312	80.6	19.4	61	104
Total (16 Southern States):							
1918-19.....	60,996	32.3	19,734	79.5	20.5	101
1917-18.....	67,430	31.0	20,900	82.8	17.2	147	171
1916-17.....	49,591	16.3	8,065	68.8	31.2	151	204
1915-16.....	56,710	27.2	15,432	82.1	17.9	70	88
Maine:							
1918-19.....	22,400	54	12,096	81	19	120
1917-18.....	18,750	55	10,313	84	16	130	135
1916-17.....	25,500	47	11,985	72	28	142	260
1915-16.....	25,418	50	12,709	82	18	70	105
New York:							
1918-19.....	34,960	50	17,480	92	8	122
1917-18.....	38,000	58	22,040	95	5	130	120
1916-17.....	22,400	41	9,184	85	15	158	275
1915-16.....	22,010	58	12,766	95	5	82	108
Pennsylvania:							
1918-19.....	24,400	42	10,248	88	12	151
1917-18.....	29,532	43	12,699	88	12	135	131
1916-17.....	19,040	32	6,092	81	19	148	264
1915-16.....	20,160	40	8,064	85	15	75	109
Ohio:							
1918-19.....	11,040	39	4,396	74	26	150
1917-18.....	16,000	53	8,480	87	13	143	134
1916-17.....	6,300	21	1,323	71	29	182	286
1915-16.....	12,546	44	5,520	84	16	70	101
Indiana:							
1918-19.....	7,760	48	2,724	81	19	135
1917-18.....	8,464	47	3,978	81	19	139	138
1916-17.....	3,256	20	652	85	15	177	272
1915-16.....	7,125	42	2,992	69	31	56	92
Illinois:							
1918-19.....	11,520	34	3,917	74	26	148
1917-18.....	13,500	40	5,400	88	12	152	153
1916-17.....	7,250	27	1,958	74	26	179	270
1915-16.....	13,860	35	4,851	74	26	59	105

POTATOES—Continued.

TABLE 90.—Potatoes: Stocks on January 1—Continued.

State and year.	Total production (000 omitted).	Stocks Jan. 1.				Price per bushel—	
		Per cent of crop.	Bushels (000 omitted).	Per cent of stock held by—		Dec. 1.	Mar. 1.
				Growers.	Dealers.		
	<i>Bushels.</i>					<i>Cents.</i>	<i>Cents.</i>
Michigan:							
1918-19.....	28,560	51	14,565	82	18	89
1917-18.....	35,910	58	20,828	88	12	105	85
1916-17.....	15,360	36	5,530	78	22	160	235
1915-16.....	20,945	57	11,938	82	18	56	86
Wisconsin:							
1918-19.....	33,010	51	16,850	80	20	80
1917-18.....	34,998	60	20,999	80	20	90	83
1916-17.....	13,630	56	7,633	79	21	147	227
1915-16.....	25,926	59	15,296	78	22	45	75
Minnesota:							
1918-19.....	32,760	42	13,759	76	24	75
1917-18.....	33,600	50	16,800	80	20	91	75
1916-17.....	16,800	37	6,216	62	38	130	210
1915-16.....	30,210	46	13,896	72	28	39	67
North Dakota:							
1918-19.....	8,910	42	3,743	86	14	73
1917-18.....	3,870	29	1,122	86	14	130	140
1916-17.....	6,975	22	1,534	63	37	115	173
1915-16.....	7,200	41	2,952	73	27	41	74
Nebraska:							
1918-19.....	10,406	37	3,851	76	24	118
1917-18.....	12,495	48	5,998	79	21	107	126
1916-17.....	7,665	29	2,223	69	31	150	228
1915-16.....	11,550	41	4,735	73	27	42	88
Kentucky:							
1918-19.....	5,625	52	2,925	75	25	165
1917-18.....	6,720	53	3,562	83	17	140	156
1916-17.....	4,116	36	1,482	89	11	142	235
1915-16.....	6,426	52	3,342	86	14	55	94
Montana:							
1918-19.....	7,020	66	4,633	82	18	80
1917-18.....	5,415	45	2,437	84	16	102	104
1916-17.....	4,875	64	3,120	63	37	120	163
1915-16.....	6,045	69	4,171	89	11	50	74
Colorado:							
1918-19.....	11,376	56	6,371	89	11	99
1917-18.....	12,800	60	7,680	90	10	91	91
1916-17.....	6,900	42	2,898	86	14	135	238
1915-16.....	7,155	55	3,935	87	13	55	71
Idaho:							
1918-19.....	5,220	58	3,028	86	14	81
1917-18.....	6,034	46	2,799	87	13	79	65
1916-17.....	4,050	44	1,782	84	16	127	175
1915-16.....	3,500	38	1,330	92	8	56	73
Washington:							
1918-19.....	8,580	62	5,320	89	11	101
1917-18.....	9,875	36	3,555	83	17	92	62
1916-17.....	9,900	32	3,168	69	31	98	168
1915-16.....	8,235	46	3,789	72	28	53	71

TABLE 91.—Potatoes: Farm price, cents per bushel, on 1st of each month, 1909-1918.

	1918	1917	1916	1915	1914	1913	1912	1911	1910	1909	Average.
Jan. 1.....	121.0	147.3	70.6	49.7	68.4	50.6	84.5	54.1	56.0	72.0	77.4
Feb. 1.....	122.9	172.4	88.0	50.4	69.7	53.1	94.4	55.1	56.2	73.3	83.6
Mar. 1.....	120.3	240.7	94.4	50.4	70.7	52.0	102.0	55.3	54.6	80.0	92.0
Apr. 1.....	92.6	234.7	97.6	47.8	70.0	50.3	117.1	55.5	47.4	86.3	89.9
May 1.....	80.1	279.6	94.8	50.5	71.4	48.2	127.3	62.5	38.4	97.3	95.0
June 1.....	75.5	274.0	98.8	50.8	71.3	55.2	119.7	63.3	37.4	97.7	94.4
July 1.....	94.9	247.9	102.3	52.1	81.5	49.8	103.6	96.3	40.1	91.0	96.0
Aug. 1.....	141.6	170.8	95.4	56.3	87.1	69.2	86.5	136.0	64.9	85.1	99.3
Sept. 1.....	148.8	139.1	109.3	50.5	74.9	75.3	65.0	113.7	72.9	71.5	92.1
Oct. 1.....	143.6	122.1	112.0	48.8	64.7	73.9	51.1	88.3	67.8	64.3	83.7
Nov. 1.....	127.2	127.8	135.7	60.8	52.8	69.6	45.5	76.3	55.7	57.8	80.9
Dec. 1.....	119.5	122.8	146.1	61.7	48.7	68.7	50.5	79.9	55.7	54.1	80.8
Average.....	121.8	164.9	114.1	54.4	64.4	64.3	72.5	80.6	56.4	70.8	86.4

POTATOES—Continued.

TABLE 92.—Potatoes: Wholesale price, 1913-1918.

Date.	New York, State and Western (per 180 pounds).			Chicago, fair to fancy (per bushel).			Minneapolis (per bushel).			St. Louis, Burbank (per bushel).			Cincinnati (per bushel).			Denver (per 100 pounds).			San Francisco (per 100 pounds).		
	Low.	High.	Average.	Low.	High.	Average.	Low.	High.	Average.	Low.	High.	Average.	Low.	High.	Average.	Low.	High.	Average.	Low.	High.	Average.
1913.																					
Jan.-June	\$1.70	\$2.87	\$0.15	\$0.70	\$0.33	\$0.60	\$0.30	\$0.87	\$0.30	\$1.00	\$0.50	\$4.00	\$0.20	\$1.65
July-Dec	1.75	2.3750	.8250	1.0045	.9365	1.0060	2.5050	1.25
1914.																					
Jan.-June	2.00	3.0056	1.7555	1.3565	1.6065	1.15	1.00	2.5080	1.65
July-Dec	1.25	2.1228	1.6528	1.5033	1.5045	1.7090	2.7560	1.30
1915.																					
Jan.-June	1.00	1.7518	1.5030	.6538	.5530	.5090	2.25	1.00	3.50
July-Dec	1.75	3.0017	.9525	1.0022	.9630	.9085	2.2585	1.50
1916.																					
Jan.-June	2.85	3.9060	1.3062	1.3573	1.3565	1.30	1.40	5.0090	2.25
July-Dec	3.40	5.2565	2.0075	1.7550	2.1080	1.90	1.65	3.25	1.00	2.50
1917.																					
January	4.75	7.00	1.60	2.25	1.50	2.25	1.70	2.18	1.85	2.20	2.25	3.50	2.00	3.00
February	6.00	10.50	1.90	3.05	1.80	2.80	1.98	2.93	2.15	3.00	3.00	5.25	2.75	4.10
March	6.75	9.00	2.00	2.85	2.10	3.05	2.13	2.70	2.45	3.00	3.50	5.25	2.75	4.00
April	7.00	10.25	2.25	4.50	2.15	3.10	2.23	3.28	2.45	3.35	3.50	5.75	2.90	5.00
May	8.25	11.00	2.00	3.75	2.35	2.90	2.25	3.35	2.50	3.25	5.00	6.50	2.50	4.50
June	9.00	11.00	1.00	3.70	2.40	4.20	3.00	3.33	2.40	3.90	4.15	6.25	1.90	4.00
Jan.-June	4.75	11.00	1.00	4.50	1.50	4.20	1.70	3.35	1.85	3.90	2.25	6.50	1.90	5.00
July	1.00	2.85	1.00	2.75	1.50	2.50	3.00	4.25	1.75	2.50
August90	1.65	1.10	1.30	1.25	1.70	2.25	4.00	2.00	2.75
September	3.00	4.7590	1.4090	1.40	1.05	1.50	1.10	1.30	2.00	2.75	1.75	2.35
October	4.00	5.75	1.00	1.6090	1.45	1.14	1.70	1.10	1.60	2.00	2.75	1.75	2.35
November	3.45	4.7596	1.50	1.17	1.5090	1.50	2.25	2.75	2.25	2.75	1.75	2.10
December	3.50	4.7393	1.3599	1.2987	1.44	2.15	2.75	2.00	2.75	1.25	1.95
July-Dec	3.00	5.7590	2.8590	2.7587	1.70	1.10	2.75	2.00	4.25	1.25	2.75

1918.		Per 100 lbs.			Per 100 lbs.			Per 100 lbs.			Per 100 lbs.											
January	2.00	3.33	\$2.68	1.85	2.25	\$2.06	1.90	2.10	\$1.98	1.75	2.40	\$2.00	1.50	2.25	\$1.80	1.25	1.75	\$1.50
February	1.80	2.80	2.39	1.40	2.25	2.02	1.90	2.10	1.98	1.60	2.45	2.01	1.50	2.00	1.75	1.00	2.00	1.39
March	1.60	2.25	1.92	.45	1.90	1.14	.80	1.60	1.25	1.00	1.80	1.33	1.25	2.00	1.93	1.00	1.90	1.25
April	1.25	2.12	1.79	.50	3.50	1.36	.90	1.35	1.15	.80	1.71	1.3075	1.50	1.11	1.00	1.50	1.25
May	1.00	2.25	1.48	.80	2.50	1.57	1.05	1.35	1.22	.85	1.60	1.3275	1.65	1.95	1.25	1.50	1.38
June	1.50	2.22	1.85	.90	3.10	1.99	1.25	3.25	2.25	1.10	2.25	1.4575	3.25	3.77	1.25	2.00	1.46
Jan.-June	1.00	3.33	2.02	.45	3.50	1.69	.80	3.25	1.64	.80	2.45	1.5775	3.25	2.05	1.00	2.00	1.37
July	1.30	3.20	2.48	1.50	3.25	2.38	1.00	3.65	5.34	1.25	2.65	2.03
August	1.80	3.25	2.41	2.50	3.65	3.20	1.90	2.75	2.44
September	1.65	3.10	2.28	2.30	2.40	2.35	2.00	2.85	2.50	2.25	2.75	2.50	1.75	2.60	2.17
October	1.75	2.40	2.15	.90	2.15	1.63	1.90	2.40	2.06	1.15	2.35	2.06	1.75	2.75	2.24	1.25	2.50	1.79
November	1.65	2.40	2.11	.85	2.30	1.57	1.50	1.70	1.59	1.07	2.45	1.98	1.75	2.25	2.00	1.50	2.10	1.84
December	1.85	2.40	2.19	.90	2.25	1.67	1.50	1.65	1.58	1.50	2.15	1.93	1.40	2.25	1.80	1.50	1.90	1.70
July-Dec	1.65	2.40	2.15	.85	3.25	2.01	1.50	3.25	2.08	1.07	2.85	1.41	1.00	3.65	2.85	1.25	2.75	2.00

POTATOES—Continued.

TABLE 93.—Potatoes: International trade, calendar years 1911–1917.

GENERAL NOTE.—Substantially the international trade of the world. It should not be expected that the world export and import totals for any year will agree. Among sources of disagreement are these: (1) Different periods of time covered in the "year" of the various countries; (2) imports received in year subsequent to year of export; (3) want of uniformity in classification of goods among countries; (4) different practices and varying degrees of failure in recording countries of origin and ultimate destination; (5) different practices of recording reexported goods; (6) opposite methods of treating free ports; (7) clerical errors, which, it may be assumed, are not infrequent.

The exports given are domestic exports, and the imports given are imports for consumption as far as it is feasible and consistent so to express the facts. While there are some inevitable omissions, on the other hand there are some duplications because of reshipments that do not appear as such in official reports. For the United Kingdom, import figures refer to imports for consumption, when available, otherwise total imports, less exports, of "foreign and colonial merchandise." Figures for the United States include Alaska, Porto Rico, and Hawaii.

EXPORTS.

[000 omitted.]

Country.	Average, 1911–1913.	1916 (prelim.)	1917 (prelim.)	Country.	Average, 1911–1913.	1916 (prelim.)	1917 (prelim.)
<i>From—</i>	<i>Bush.</i>	<i>Bush.</i>	<i>Bush.</i>	<i>From—</i>	<i>Bush.</i>	<i>Bush.</i>	<i>Bush.</i>
Argentina.....	543	1,014	542	Netherlands.....	16,451	6,238
Austria-Hungary.....	1,451	Portugal.....	506
Belgium.....	8,692	Russia.....	7,762	45
Canada.....	1,207	1,558	4,039	Spain.....	1,835	1,957	900
China.....	288	334	242	United Kingdom.....	6,246	1,346
Denmark.....	928	United States.....	1,814	3,230	2,425
France.....	8,683	1,819	Other countries.....	1,924
Germany.....	12,412	Total.....	75,151
Italy.....	3,975	2,066	583				
Japan.....	440	454				

IMPORTS.

<i>Into—</i>				<i>Into—</i>			
Algeria.....	1,218	Norway.....	215	488
Argentina.....	1,337	235	15	Philippine Islands.....	334	305	287
Austria-Hungary.....	4,070	Portugal.....	273
Belgium.....	4,921	Russia.....	309	2
Brazil.....	939	167	Sweden.....	700
Canada.....	525	573	463	Switzerland.....	3,172	2,857
Cuba.....	2,001	United Kingdom.....	11,382	3,331
Egypt.....	599	353	United States.....	5,707	886	3,182
Finland.....	479	109	Other countries.....	2,311
France.....	7,143	2,577	Total.....	78,767
Germany.....	29,180				
Netherlands.....	1,952	2				

SWEET POTATOES.

TABLE 94.—Sweet potatoes: Acreage, production, and value, in the United States, 1849-1918.

NOTE.—Figures in *italics* are census returns; figures in roman are estimates of the Department of Agriculture. Estimates of acres are obtained by applying estimated percentages of increase or decrease to the published numbers of the preceding year, except that a revised base is used for applying percentage estimates whenever new census data are available.

Year.	Acreage.	Average yield per acre.	Production.	Average farm price per bushel Dec. 1.	Farm value Dec. 1.
	<i>Acres.</i>	<i>Bushels.</i>	<i>Bushels.</i>	<i>Cents.</i>	<i>Dollars.</i>
1849			38,268,000		
1859			42,095,000		
1869			21,710,000		
1879			33,379,000		
1889			43,950,000		
1899	537,000	79.1	42,517,000	52.9	22,476,000
1900	544,000	88.9	48,346,000	50.6	24,478,000
1901	547,000	81.7	44,697,000	57.5	25,720,000
1902	532,000	85.2	45,344,000	58.1	26,358,000
1903	548,000	89.2	48,870,000	58.3	28,478,000
1904	548,000	88.9	48,705,000	60.4	29,424,000
1905	551,000	92.6	51,034,000	58.3	29,734,000
1906	554,000	90.2	49,948,000	62.2	31,063,000
1907	565,000	88.2	49,813,000	70.0	34,858,000
1908	599,000	92.4	55,352,000	66.1	36,564,000
1909	641,000	92.4	59,232,000	69.4	41,052,000
1910	641,000	93.5	59,938,000	67.1	40,216,000
1911	605,000	90.1	54,538,000	75.5	41,202,000
1912	583,000	95.2	55,479,000	72.6	40,264,000
1913	625,000	94.5	59,057,000	72.6	42,884,000
1914	603,000	93.8	56,574,000	73.0	41,294,000
1915	731,000	103.5	75,639,000	62.1	46,980,000
1916	774,000	91.7	70,955,000	84.8	60,141,000
1917	919,000	91.2	83,822,000	110.8	92,916,000
1918	922,000	93.6	86,334,000	135.4	116,867,000

TABLE 95.—Sweet potatoes: Acreage, production, and total farm value, by States, 1918.

[000 omitted.]

State.	Acreage.	Production.	Farm value Dec. 1.	State.	Acreage.	Production.	Farm value Dec. 1.
	<i>Acres.</i>	<i>Bushels.</i>	<i>Dollars.</i>		<i>Acres.</i>	<i>Bushels.</i>	<i>Dollars.</i>
New Jersey	23	2,875	5,462	Missouri	8	728	1,354
Pennsylvania	1	120	222	Kansas	4	320	710
Delaware	5	600	750	Kentucky	13	1,235	2,161
Maryland	11	1,430	2,145	Tennessee	30	2,940	3,998
Virginia	28	3,360	4,872	Alabama	153	14,688	16,891
West Virginia	2	212	432	Mississippi	89	8,455	8,793
North Carolina	81	8,910	11,761	Louisiana	65	4,875	6,240
South Carolina	80	7,600	10,792	Texas	87	5,046	8,830
Georgia	130	11,960	14,950	Oklahoma	15	975	2,145
Florida	36	3,960	4,950	Arkansas	38	3,420	4,720
Ohio	1	96	168	New Mexico	2	250	625
Indiana	3	324	632	California	6	1,020	1,530
Illinois	8	656	1,148				
Iowa	3	279	586	United States..	922	86,334	116,867

SWEET POTATOES—Continued.

TABLE 96.—Sweet potatoes: Condition of crop, United States, on 1st of months named, 1898-1918.

Year.	1898-1904				1905-1911				1912-1918					
	July.	Aug.	Sept.	Oct.	Year.	July.	Aug.	Sept.	Oct.	Year.	July.	Aug.	Sept.	Oct.
	<i>P. ct.</i>	<i>P. ct.</i>	<i>P. ct.</i>	<i>P. ct.</i>		<i>P. ct.</i>	<i>P. ct.</i>	<i>P. ct.</i>	<i>P. ct.</i>		<i>P. ct.</i>	<i>P. ct.</i>	<i>P. ct.</i>	<i>P. ct.</i>
1898.....	92.0	90.6	89.9	89.9	1905.....	90.6	90.1	89.5	88.6	1912.....	86.9	85.0	84.1	82.0
1899.....	85.1	84.1	80.7	74.9	1906.....	90.9	91.2	88.7	86.0	1913.....	86.5	85.8	81.4	80.1
1900.....	93.7	92.2	83.6	80.0	1907.....	89.5	85.7	85.7	82.7	1914.....	77.1	75.5	81.8	80.7
1901.....	93.1	80.7	78.7	79.0	1908.....	89.8	88.8	88.7	85.5	1915.....	88.7	85.5	87.5	85.0
1902.....	83.6	78.3	77.2	79.7	1909.....	89.7	86.9	81.3	77.8	1916.....	90.4	85.9	82.7	79.2
1903.....	90.2	88.7	91.1	83.7	1910.....	87.3	85.4	83.9	80.2	1917.....	81.9	84.8	85.7	83.2
1904.....	87.3	88.5	89.9	86.1	1911.....	78.4	77.7	79.1	78.1	1918.....	86.4	78.3	74.5	77.4

TABLE 97.—Sweet potatoes: Yield per acre, price per bushel Dec. 1, and value per acre, by States.

State.	Yield per acre (bushels).										Farm price per bushel (cents).					Value per acre (dollars). ¹			
	10-year average, 1909-1918.										10-year average, 1909-1918.					5-year average, 1914-1918.			
	1909.	1910.	1911.	1912.	1913.	1914.	1915.	1916.	1917.	1918.	1914.	1915.	1916.	1917.	1918.	1918.	1918.		
N. J.....	125	123	140	130	120	138	100	155	100	120	125	104	95	70	120	160	190	150.60	237.50
Pa.....	108	88	105	121	120	110	105	105	100	110	120	106	86	75	135	140	185	136.01	222.00
N. C.....	125	125	115	140	120	135	120	135	125	112	120	77	70	62	81	120	125	110.67	150.00
Del.....	124	115	110	115	125	141	125	130	126	118	130	80	70	70	88	100	150	120.48	195.00
Md.....	104	100	100	90	90	108	92	110	130	104	120	84	76	65	90	110	145	109.36	174.00
Va.....	110	100	101	110	115	91	92	110	140	140	106	112	98	92	126	140	204	156.00	216.24
W. Va.....	99	99	105	86	90	100	90	105	107	95	110	73	65	56	75	105	132	88.50	145.20
S. C.....	93	95	91	84	105	92	85	105	86	95	95	81	80	65	85	104	142	86.91	134.90
Ga.....	87	93	83	81	90	87	85	85	80	93	92	78	69	61	81	105	125	77.59	115.00
Fla.....	108	105	108	108	112	110	120	112	100	95	110	85	80	68	86	115	125	100.98	137.50
Ohio.....	102	110	98	113	118	90	110	95	99	95	96	116	96	98	150	175	175	136.29	168.00
Ind.....	103	101	104	114	116	78	100	104	100	106	108	114	90	90	150	165	195	143.82	210.60
Ill.....	94	110	110	89	98	70	84	110	90	97	82	111	95	82	125	150	175	114.30	143.50
Iowa.....	95	110	98	105	90	80	100	95	91	90	93	141	127	108	192	210	210	157.72	195.30
Mo.....	88	90	102	91	88	56	84	100	70	112	91	113	96	82	150	141	186	118.96	169.26
Kans.....	90	96	101	75	99	50	110	110	92	92	80	129	106	100	150	160	222	137.88	177.60
Tenn.....	92	88	85	96	90	75	105	105	90	95	95	96	77	70	100	125	175	105.87	166.25
Ky.....	92	87	85	85	90	80	100	105	100	95	98	82	69	59	87	105	136	90.20	133.28
Ala.....	90	80	85	97	100	95	93	90	74	90	96	74	65	57	74	92	115	71.94	110.40
Miss.....	90	82	94	85	97	98	90	110	82	65	95	70	63	55	67	97	104	66.80	98.80
La.....	86	90	93	90	84	85	87	92	90	79	75	73	64	50	66	104	128	67.85	96.00
Tex.....	76	50	56	71	75	80	101	98	89	78	58	107	87	70	90	140	175	89.45	101.50
Okla.....	82	70	70	75	92	64	102	115	74	90	65	124	89	73	135	160	220	112.33	143.00
Ark.....	94	58	98	92	88	90	95	130	91	110	90	88	77	61	90	96	138	92.83	124.20
N. Mex.....	137	180	100	150	141	125	143	160	125	118	125	148	113	120	180	205	250	226.60	312.50
Calif.....	158	160	160	140	156	170	161	135	160	167	170	106	87	80	150	150	150	182.71	255.00
U. S.....	93.7	90.1	93.5	90.1	95.2	94.5	93.8	103.5	91.7	91.2	93.6	82.5	73.0	62.1	84.8	110.8	135.4	87.66	126.75

¹ Based upon farm price Dec. 1.

TABLE 98.—Sweet potatoes: Farm price, cents per bushel on 1st of each month, 1910-1918.

Date.	1918	1917	1916	1915	1914	1913	1912	1911	1910
Jan. 1.....	117.2	90.1	64.9	79.0	79.2	80.4	83.0	75.0
Feb. 1.....	123.1	95.8	71.2	82.0	84.3	85.4	90.2	80.4	76.8
Mar. 1.....	142.7	110.7	77.3	84.7	86.7	88.9	98.0	84.4	79.4
Apr. 1.....	151.6	124.0	78.0	90.7	89.6	92.6	109.9	91.2	82.4
May 1.....	155.0	141.3	80.5	95.6	94.5	93.8	118.0	99.3	83.4
June 1.....	148.8	149.4	83.4	96.7	94.2	92.0	115.0	98.7	79.4
July 1.....	134.3	140.5	79.4	88.9	82.6	90.1	112.2	99.0	75.1
Aug. 1.....	144.7	129.3	87.1	85.8	97.5	94.1	107.8	105.8	78.2
Sept. 1.....	156.2	132.6	89.9	84.6	92.8	94.3	95.7	102.6	81.2
Oct. 1.....	160.6	116.1	83.7	72.7	87.3	83.9	84.4	91.8	77.6
Nov. 1.....	146.0	111.2	80.6	63.7	76.3	75.7	76.8	80.9	71.8
Dec. 1.....	135.4	110.8	84.8	62.1	73.0	72.6	72.6	75.5	67.1

SWEET POTATOES—Continued.

TABLE 99.—Sweet potatoes: Wholesale price per barrel, 1913-1918.

Date.	Baltimore.			St. Louis (per bushel).			New Orleans.			New York.					
										Jersey.			Southern.		
	Low.	High.	Average.	Low.	High.	Average.	Low.	High.	Average.	Low.	High.	Average.	Low.	High.	Average.
1913.															
Jan.-June.....	\$2.00	\$3.50		\$1.63	\$3.75		\$2.00	\$2.00		\$2.00	\$3.00		\$1.75	\$2.50	
July-Dec.....	.75	7.00		.88	6.25		2.00	2.00		1.25	3.50		.40	5.50	
1914.															
Jan.-June.....	1.00	2.50		1.50	2.50		1.00	3.20		1.50	2.00		.75	1.50	
July-Dec.....	1.00	5.50		1.75	4.50		.80	3.50		2.00	3.50		.75	5.00	
1915.															
Jan.-June.....	1.50	5.50		2.50	4.50		1.00	3.00		2.50	3.00		2.00	3.50	
July-Dec.....	.75	6.50		1.50	3.40		.70	3.00		.50	2.50		.50	5.00	
1916.															
Jan.-June.....	1.00	3.00		1.50	2.65		.50	1.70		1.75	2.50		1.00	2.00	
July-Dec.....	1.25	5.50		2.00	3.25		.80	2.50		2.00	3.25		1.00	5.50	
1917.															
January.....	2.75	4.00		.75	1.40		.65	.90							
February.....	3.00	5.50		1.10	2.00		.75	1.25							
March.....	4.00	5.50		1.25	2.00		.65	1.25					3.75	5.25	
April.....	3.50	6.00		1.50	2.25		1.00	2.25					2.50	5.00	
May.....	4.50	6.00		2.00	2.75		2.00	2.25							
June.....	4.50	6.00													
Jan.-June.....	2.75	6.00		.75	2.75		.65	2.25					2.50	5.25	
July.....	10.00	12.00													
August.....	3.00	8.50		1.25	2.50								1.25	9.00	
September.....	2.50	4.25		.50	1.75					4.00	5.00		1.25	5.75	
October.....	2.25	3.50		.40	1.35					3.25	5.00		1.50	5.00	
November.....	.50	3.50		.75	1.50		.90	1.60		1.50	5.00		.50	4.00	
December.....	1.00	6.00		1.10	2.00		.80	1.60					1.00	4.00	
July-Dec.....	.50	12.00		.40	2.50		.80	1.60		1.50	5.00		.50	9.00	
1918.															
January.....	1.00	6.00	\$3.64	1.50	1.75	\$1.61	3.00	4.60	\$3.67				1.50	2.50	\$2.00
February.....	2.00	6.00	4.94	.80	2.25	1.72	2.20	4.00	2.84						
March.....	3.00	5.00	3.97	1.35	2.25	2.05	2.00	3.60	2.55						
April.....	3.00	5.25	4.46	(¹)		(²)	3.50	7.00	4.71						
May.....	4.00	6.50	5.61	(³)		(⁴)									
June.....	7.00	8.00	7.50												
Jan.-June.....	1.00	8.00	5.02	.80	2.25	1.79	2.00	7.00	3.44				1.50	2.50	2.00
July.....	9.00	10.00	9.50				3.20	4.80	3.91						
August.....	6.00	9.00	7.51	1.00	3.00	2.24	3.20	4.80	3.79				1.25	10.00	5.14
September.....	3.75	6.00	5.00	.65	3.25	1.72	2.40	4.00	3.24				1.50	7.50	3.89
October.....	2.50	3.75	2.99	.70	1.75	1.26	2.00	4.40	2.71				1.50	4.50	2.87
November.....	3.00	6.50	4.25	1.00	1.85	1.47	1.20	4.40	1.73				2.00	6.50	4.53
December.....	5.00	8.00	6.06	1.25	2.15	1.67	1.00	2.25	1.72				1.50	6.50	4.66
July-Dec.....	2.50	10.00	5.88	.65	3.25	1.67	1.00	4.80	2.85				1.25	10.00	4.22

12 to 6 cents per pound. ² 4.5 cents per pound. ³ 5 to 7 cents per pound. ⁴ 6.0 cents per pound.

HAY.

TABLE 100.—Hay: Acreage, production, value, exports, etc., in the United States, 1849-1918.

NOTE.—Figures in *italics* are census returns; figures in roman are estimates of the Department of Agriculture. Estimates of acres are obtained by applying estimated percentages of increase or decrease to the published numbers of the preceding year, except that a revised base is used for applying percentage estimates whenever new census data are available.

Year.	Acreage.	Average yield per acre.	Production.	Average farm price per ton Dec. 1.	Farm value Dec. 1.	Chicago prices No. 1 timothy per ton, by carload lots.				Domestic exports fiscal year beginning July 1.
						December.		Following May.		
						Low.	High.	Low.	High.	
	<i>Acres.</i>	<i>Tons.¹</i>	<i>Tons.¹</i>	<i>Dolls.</i>	<i>Dollars.</i>	<i>Dolls.</i>	<i>Dolls.</i>	<i>Dolls.</i>	<i>Dolls.</i>	<i>Tons.²</i>
1849			13,839,000							
1850			19,084,000							
1866	17,669,000	1.23	21,779,000	10.14	220,835,000					5,028
1867	20,021,000	1.31	26,277,000	10.21	268,301,000					5,645
1868	21,542,000	1.21	26,142,000	10.08	263,589,000					
1869	18,591,000	1.42	26,420,000	10.18	268,933,000					6,723
1869			<i>27,316,000</i>							
1870	19,862,000	1.23	24,525,000	12.47	305,743,000					4,581
1871	19,009,000	1.17	22,239,000	14.30	317,940,000					5,266
1872	20,319,000	1.17	23,813,000	12.94	308,025,000					4,557
1873	21,894,000	1.15	25,085,000	12.53	314,241,000					4,889
1874	21,770,000	1.15	25,134,000	11.94	300,222,000					7,183
1875	23,508,000	1.19	27,874,000	10.78	300,378,000					7,528
1876	25,283,000	1.22	30,867,000	8.97	276,991,000			9.00	10.00	7,287
1877	25,368,000	1.25	31,629,000	8.37	264,890,000	9.50	10.50	9.75	10.75	9,514
1878	26,931,000	1.47	39,608,000	7.20	285,016,000	8.00	8.50	9.00	11.50	8,127
1879	27,485,000	1.29	35,493,000	9.32	330,804,000	14.00	14.50	14.00	15.00	13,739
1879			<i>35,151,000</i>							
1880	25,864,000	1.23	31,925,000	11.65	371,811,000	15.00	15.50	17.00	19.00	12,662
1881	30,889,000	1.14	35,135,000	11.82	415,131,000	16.00	16.50	15.00	16.50	10,570
1882	32,340,000	1.18	38,138,000	9.73	371,170,000	11.50	12.25	12.00	13.00	13,309
1883	35,516,000	1.32	46,864,000	8.19	383,834,000	9.00	10.00	12.50	17.00	16,908
1884	38,572,000	1.26	48,470,000	8.17	396,139,000	10.00	11.50	15.50	17.50	11,142
1885	39,850,000	1.12	44,732,000	8.71	389,753,000	11.00	12.00	10.00	12.00	13,390
1886	36,502,000	1.15	41,796,000	8.46	353,438,000	9.50	10.50	11.00	12.50	13,873
1887	37,665,000	1.10	41,454,000	9.97	413,440,000	13.50	14.50	17.00	21.00	18,195
1888	38,592,000	1.21	46,643,000	8.76	408,500,000	11.00	11.50	10.50	21.00	21,928
1889	52,949,000	1.26	66,831,000	7.04	470,394,000	9.00	10.00	9.00	14.00	36,274
1889			<i>66,831,000</i>							
1890	50,713,000	1.19	60,198,000	7.87	473,570,000	9.00	10.50	12.50	15.50	28,066
1891	51,044,000	1.19	60,818,000	8.12	494,114,000	12.50	15.00	13.50	14.00	35,201
1892	50,853,000	1.18	59,824,000	8.20	490,428,000	11.00	11.50	12.00	13.50	33,084
1893	49,613,000	1.33	65,766,000	8.68	570,883,000	10.00	10.50	10.00	10.50	54,446
1894	48,321,000	1.14	54,874,000	8.54	468,578,000	10.00	11.00	10.00	10.25	47,117
1895	44,206,000	1.06	47,079,000	8.35	393,186,000	12.00	12.50	11.50	12.00	50,052
1896	43,260,000	1.37	59,282,000	6.55	388,146,000	8.00	8.50	8.50	9.00	61,658
1897	42,427,000	1.43	60,665,000	6.62	401,391,000	8.00	8.50	9.50	10.50	81,827
1898	42,781,000	1.55	66,377,000	6.00	398,061,000	8.00	8.25	9.50	10.50	64,916
1899	41,328,000	1.37	56,656,000	7.27	411,926,000	10.50	11.50	10.50	12.50	72,716
1899			<i>53,828,000</i>							
1900	39,133,000	1.28	50,111,000	8.89	445,539,000	11.50	14.00	12.50	13.50	89,364
1901	39,391,000	1.28	50,591,000	10.01	506,192,000	13.00	13.50	12.50	13.50	153,431
1902	39,825,000	1.50	59,858,000	9.06	542,036,000	12.00	12.50	13.50	15.00	50,974
1903	39,934,000	1.54	61,306,000	9.07	556,276,000	10.00	12.00	12.00	15.00	60,730
1904	39,999,000	1.52	60,696,000	8.72	529,108,000	10.50	11.50	11.00	12.00	66,557
1905	39,362,000	1.54	60,532,000	8.52	515,930,000	10.00	12.00	11.50	12.50	70,172
1906	42,476,000	1.35	57,146,000	10.37	592,540,000	15.50	18.00	15.50	20.50	58,602
1907	44,028,000	1.45	63,677,000	11.68	743,507,000	13.00	17.50	13.00	14.00	77,281
1908	45,970,000	1.52	70,050,000	9.02	631,683,000	11.50	12.00	12.00	13.00	64,641
1909	45,744,000	1.42	64,938,000							
1909			<i>68,833,000</i>	10.49	722,385,000	16.00	17.00	12.50	16.00	55,007
1910 ³	51,015,000	1.36	69,378,000	12.14	842,252,000	16.00	19.00	18.50	23.50	55,222
1911	48,240,000	1.14	54,916,000	14.29	784,926,000	20.00	22.00	24.00	28.00	59,730
1912	49,530,000	1.47	72,691,000	11.79	856,695,000	13.00	18.00	14.00	16.50	60,720
1913	48,954,000	1.31	64,116,000	12.43	797,077,000	14.50	18.00	15.00	17.50	50,151
1914	49,145,000	1.43	70,071,000	11.12	779,068,000	15.00	16.00	16.50	17.50	105,508
1915	51,108,000	1.68	85,920,000	10.63	913,644,000	14.50	16.50	17.50	20.00	178,336
1916	55,721,000	1.64	91,192,000	11.22	1,022,930,000	15.00	17.50	19.00	22.00	85,529
1917	55,203,000	1.51	83,308,000	17.09	1,423,766,000	26.00	28.00	20.00	26.00	30,145
1918	55,971,000	1.36	76,069,000	20.04	1,524,307,000	29.00	31.00			

¹ 2,000 pounds.² 2,240 pounds.³ Figures adjusted to census basis.

HAY—Continued.

TABLE 101.—Hay: Revised acreage, production, and farm value, 1879 and 1889–1909.

[See head note to Table 86.]

Year.	Acreage.	Average yield per acre.	Production.	Average farm price per ton Dec. 1.	Farm value Dec. 1.
	<i>Acres.</i>	<i>Tons.</i>	<i>Tons.</i>	<i>Dollars.</i>	<i>Dollars.</i>
1879.....	30,631,000	1.30	39,862,000	9.31	371,045,000
1889.....	39,004,000	1.26	49,181,000	7.76	381,481,000
1890.....	40,038,000	1.23	49,057,000	8.18	401,111,000
1891.....	41,258,000	1.18	48,759,000	8.89	433,276,000
1892.....	42,191,000	1.17	49,238,000	8.95	440,710,000
1893.....	42,413,000	1.31	55,575,000	9.48	527,044,000
1894.....	42,772,000	1.18	50,468,000	8.96	452,079,000
1895.....	40,832,000	1.02	41,838,000	9.46	395,647,000
1896.....	40,978,000	1.33	54,380,000	7.48	406,957,000
1897.....	41,336,000	1.42	58,878,000	7.28	428,919,000
1898.....	43,120,000	1.55	66,772,000	6.63	442,905,000
1899.....	43,127,000	1.33	57,450,000	8.20	470,844,000
1900.....	42,070,000	1.27	53,231,000	9.72	517,399,000
1901.....	42,066,000	1.33	55,819,000	9.91	553,328,000
1902.....	42,962,000	1.2	65,296,000	9.19	599,781,000
1903.....	43,400,000	1.57	68,154,000	9.35	637,485,000
1904.....	44,645,000	1.55	69,192,000	8.91	616,369,000
1905.....	45,991,000	1.59	72,973,000	8.59	627,023,000
1906.....	47,891,000	1.39	66,341,000	10.43	692,116,000
1907.....	49,098,000	1.47	72,261,000	11.78	850,915,000
1908.....	51,196,000	1.53	78,440,000	9.14	716,644,000
1909.....	51,041,000	1.46	74,384,000	10.58	786,722,000

TABLE 102.—Hay: Acreage, production, and total farm value, by States, 1918.

[000 omitted.]

State.	Acreage.	Production.	Farm value Dec. 1.	State.	Acreage.	Production.	Farm value Dec. 1.
	<i>Acres.</i>	<i>Bushels.</i>	<i>Dollars.</i>		<i>Acres.</i>	<i>Bushels.</i>	<i>Dollars.</i>
Maine.....	1,196	1,375	19,112	North Dakota.....	522	574	8,380
New Hampshire.....	472	543	10,208	South Dakota.....	772	1,235	12,350
Vermont.....	993	1,291	21,043	Nebraska.....	1,701	2,381	40,953
Massachusetts.....	469	563	14,638	Kansas.....	1,869	3,227	62,604
Rhode Island.....	58	75	1,912	Kentucky.....	1,072	1,394	33,038
Connecticut.....	403	524	12,576	Tennessee.....	1,200	1,620	38,880
New York.....	4,300	5,375	109,650	Alabama.....	1,596	1,293	26,248
New Jersey.....	350	490	13,720	Mississippi.....	347	416	7,696
Pennsylvania.....	3,030	4,272	101,246	Louisiana.....	200	260	5,512
Delaware.....	80	100	2,800	Texas.....	581	581	14,467
Maryland.....	473	639	17,125	Oklahoma.....	564	677	13,202
Virginia.....	1,142	1,542	35,466	Arkansas.....	403	524	10,218
West Virginia.....	798	1,037	24,370	Montana.....	767	1,227	24,049
North Carolina.....	590	684	14,364	Wyoming.....	580	1,218	17,052
South Carolina.....	260	286	7,465	Colorado.....	951	2,045	31,698
Georgia.....	683	615	14,452	New Mexico.....	164	361	7,220
Florida.....	120	120	2,220	Arizona.....	150	480	11,520
Ohio.....	2,925	4,095	90,909	Utah.....	434	1,020	17,442
Indiana.....	2,210	3,204	63,439	Nevada.....	221	575	11,442
Illinois.....	3,372	4,552	95,592	Idaho.....	667	1,934	34,038
Michigan.....	2,598	2,676	62,886	Washington.....	794	1,429	36,297
Wisconsin.....	2,582	3,537	76,399	Oregon.....	815	1,467	29,340
Minnesota.....	1,850	2,590	36,519	California.....	2,376	2,970	59,400
Iowa.....	3,297	4,286	78,005	United States.....	55,971	76,069	1,524,307
Missouri.....	2,989	2,690	55,145				

HAY—Continued.

TABLE 103.—Hay: Yield per acre, price per ton Dec. 1, and value per acre, by States.

State.	Average yield per acre (tons).										Farm price per ton (dollars).					Value per acre (dollars). ¹			
	10-year average 1909-1918.	1909	1910	1911	1912	1913	1914	1915	1916	1917	1918	10-year average 1909-1918.	1914	1915	1916	1917	1918	5-year average 1914-1918.	1918
Me.....	1.17	0.95	1.25	1.10	1.16	1.00	1.15	1.15	1.45	1.35	1.15	13.49	13.10	14.90	12.40	11.10	13.90	16.23	15.98
N. H.....	1.16	.97	1.20	1.05	1.25	1.00	1.15	1.00	1.45	1.35	1.15	16.28	17.00	17.40	14.50	12.00	18.80	19.16	21.62
Vt.....	1.38	1.25	1.35	1.30	1.50	1.28	1.20	1.35	1.70	1.62	1.30	14.01	14.60	15.50	12.60	11.50	16.30	19.94	21.19
Mass.....	1.30	1.15	1.28	1.08	1.25	1.21	1.32	1.50	1.56	1.50	1.20	21.20	21.50	22.00	19.00	19.90	26.00	30.41	31.20
R. I.....	1.21	1.10	1.18	1.00	1.13	1.17	1.17	1.24	1.35	1.50	1.30	21.42	20.20	22.50	20.00	20.30	25.50	28.43	33.15
Conn.....	1.28	1.15	1.35	1.10	1.15	1.14	1.25	1.35	1.55	1.50	1.30	20.59	19.50	20.00	18.50	19.50	24.00	28.10	31.20
N. Y.....	1.20	1.05	1.32	1.02	1.25	1.14	1.20	1.30	1.62	1.46	1.25	15.37	14.60	15.70	11.90	15.10	20.40	20.95	25.50
N. J.....	1.38	1.25	1.50	1.05	1.44	1.30	1.35	1.45	1.60	1.45	1.40	19.98	19.50	19.00	17.60	20.00	28.00	30.05	39.20
Pa.....	1.34	1.20	1.38	1.00	1.43	1.32	1.28	1.40	1.60	1.41	1.41	16.52	14.50	15.60	13.80	17.59	23.70	24.12	33.42
Del.....	1.26	1.40	1.43	.88	1.33	1.30	1.10	1.20	1.45	1.26	1.25	18.14	17.00	17.00	15.90	20.50	28.00	24.60	35.00
Md.....	1.25	1.20	1.35	.72	1.51	1.26	1.15	1.20	1.48	1.25	1.35	17.40	15.30	16.20	14.00	19.90	26.80	23.76	36.18
Va.....	1.15	1.30	1.19	.64	1.20	1.27	.72	1.35	1.35	1.16	1.35	17.12	17.20	15.00	15.70	15.00	23.00	21.92	31.05
W. Va.....	1.23	1.25	1.20	.66	1.38	1.25	.92	1.50	1.54	1.27	1.30	16.95	17.20	15.00	14.50	21.10	23.50	23.60	30.55
N. C.....	1.31	1.38	1.50	1.00	1.30	1.31	1.15	1.85	1.30	1.13	1.16	17.10	17.10	16.50	17.50	19.70	21.00	23.89	24.36
S. C.....	1.18	1.23	1.25	1.08	1.15	1.16	1.15	1.30	1.30	1.08	1.10	18.12	17.00	15.60	16.70	20.60	26.10	22.50	28.71
Ga.....	1.24	1.35	1.40	1.35	1.35	1.40	1.35	1.15	1.15	1.03	.90	17.51	16.20	15.10	16.20	20.00	23.50	19.92	21.15
Fla.....	1.26	1.38	1.33	1.30	1.25	1.35	1.35	1.20	1.25	1.10	1.14	17.27	17.20	16.00	16.00	18.20	18.50	20.71	21.09
Ohio.....	1.34	1.43	1.39	.98	1.36	1.30	1.13	1.44	1.57	1.42	1.40	14.60	13.40	12.70	10.60	19.00	22.20	21.63	31.08
Ind.....	1.28	1.40	1.30	.94	1.37	1.00	1.00	1.50	1.44	1.45	1.45	13.92	14.11	11.00	10.90	18.70	19.80	20.43	28.71
Ill.....	1.23	1.45	1.33	.82	1.30	.98	.85	1.54	1.45	1.25	1.35	14.31	14.40	10.80	11.30	20.00	21.00	19.72	28.35
Mich.....	1.30	1.30	1.30	1.16	1.33	1.05	1.28	1.40	1.70	1.50	1.03	14.27	12.00	12.20	10.00	17.20	23.50	19.91	24.20
Wis.....	1.52	1.53	1.00	1.20	1.60	1.62	1.75	1.75	1.70	1.70	1.37	13.32	9.30	9.90	11.60	17.30	21.60	22.46	29.59
Minn.....	1.54	1.75	1.00	1.00	1.53	1.50	1.89	1.91	1.85	1.55	1.40	8.57	6.10	6.40	7.00	12.10	14.10	21.08	19.74
Iowa.....	1.37	1.64	1.05	.80	1.40	1.48	1.38	1.80	1.60	1.23	1.10	11.11	10.10	8.70	9.00	16.80	18.20	17.66	23.66
Mo.....	1.07	1.35	1.30	.60	1.30	.60	.70	1.52	1.30	1.15	.90	12.45	13.60	8.50	9.30	17.50	20.50	14.62	18.45
N. Dak.....	1.22	1.37	.55	1.10	1.40	1.14	1.45	1.50	1.70	.88	1.10	7.39	5.20	5.70	6.00	11.50	14.60	10.49	16.06
S. Dak.....	1.42	1.50	.80	.55	1.46	1.20	1.70	2.00	1.90	1.50	1.60	7.03	5.70	5.30	5.40	10.60	10.00	12.49	16.08
Nebr.....	1.54	1.50	1.00	.85	1.35	1.34	1.69	2.60	2.10	1.60	1.40	9.39	6.90	5.80	7.10	15.20	17.20	18.01	24.08
Kans.....	1.51	1.45	1.15	.85	1.50	.90	1.51	2.30	1.55	2.18	1.72	10.04	7.40	5.69	7.60	16.60	19.40	21.08	33.37
Ky.....	1.20	1.36	1.29	.95	1.23	.87	.95	1.40	1.40	1.30	1.30	15.76	16.00	12.50	12.60	20.30	23.70	21.51	30.81
Tenn.....	1.30	1.50	1.40	1.00	1.30	1.21	1.20	1.47	1.38	1.20	1.35	16.41	17.00	13.90	15.00	19.30	24.00	23.42	32.40
Ala.....	1.24	1.50	1.43	1.40	1.25	1.36	1.31	1.45	1.10	.80	.81	14.40	13.80	12.40	13.00	16.20	20.30	15.95	16.44
Miss.....	1.41	1.47	1.42	1.50	1.48	1.33	1.45	1.40	1.40	1.45	1.20	12.85	12.00	11.00	11.00	15.30	18.50	18.52	22.20
La.....	1.60	1.50	1.75	1.30	1.65	1.50	1.90	1.75	1.70	1.60	1.30	12.82	12.00	10.30	11.00	14.30	21.20	21.99	27.56
Tex.....	1.23	.95	1.15	1.00	1.40	1.16	1.75	1.70	1.20	1.00	1.00	13.11	9.80	7.90	10.50	20.00	24.90	17.62	24.90
Okl.....	1.28	.90	1.05	.80	1.25	.85	1.13	2.30	1.70	1.60	1.20	9.89	7.90	5.60	9.00	15.40	19.50	17.03	23.40
Ark.....	1.28	1.25	1.35	1.15	1.23	1.20	1.05	1.60	1.25	1.47	1.30	13.09	12.90	10.30	12.50	15.40	19.50	18.73	25.35
Mont.....	1.81	1.79	1.40	2.00	1.90	1.80	2.50	2.00	1.70	1.40	1.60	11.58	8.70	7.50	11.00	18.60	19.60	22.57	31.00
Wyo.....	2.08	2.40	2.40	2.10	1.90	1.90	2.30	2.20	1.80	1.70	2.10	10.53	7.50	7.80	12.00	17.00	14.00	22.86	29.40
Colo.....	2.20	2.50	2.00	2.00	2.19	2.05	2.40	2.20	2.05	2.45	2.15	10.69	7.40	7.60	11.00	16.60	15.50	26.20	33.32
N. Mex.....	2.25	2.60	2.10	2.60	2.33	2.08	2.50	2.20	2.00	1.90	2.20	12.93	9.30	8.80	14.00	21.00	20.00	30.90	44.00
Ariz.....	3.36	3.30	2.10	3.86	3.40	3.00	3.20	3.80	3.50	3.20	14.25	8.80	9.60	14.50	24.80	24.00	55.52	76.80	
Utah.....	2.62	2.90	3.00	2.50	2.78	2.33	2.75	2.50	2.20	2.90	2.35	10.69	7.70	8.00	15.00	15.00	17.10	31.57	40.18
Nev.....	2.90	2.35	3.40	3.40	3.00	2.75	3.25	3.00	2.40	2.90	2.60	11.17	8.30	7.50	9.60	15.90	19.30	34.07	51.74
Idaho.....	2.84	2.85	3.00	3.10	2.80	2.90	2.65	2.70	2.50	3.00	2.90	9.99	7.30	7.70	12.10	16.00	17.60	33.88	51.04
Wash.....	2.20	2.10	2.10	2.40	2.20	2.30	2.20	2.30	2.40	2.20	1.80	14.37	11.10	10.80	13.80	20.00	25.40	34.38	45.72
Oreg.....	2.08	2.05	2.10	2.10	2.20	2.10	2.00	2.20	2.30	1.95	1.80	11.78	9.20	9.50	10.90	17.50	20.00	26.90	36.00
Calif.....	1.71	1.70	1.83	1.75	1.53	1.50	1.95	1.80	1.75	2.00	1.25	13.04	8.20	11.20	12.60	19.20	20.00	24.32	25.00
U. S.....	1.43	1.42	1.36	1.14	1.47	1.31	1.43	1.68	1.64	1.51	1.36	13.14	11.12	10.63	11.22	17.09	20.04	21.02	27.23

¹ Based upon farm price Dec. 1.

HAY—Continued.

TABLE 104.—Hay: Stocks on May 1.

Year.	Production of all hay preceding year (tons).	Per cent on farms May 1.	Tons on farms May 1.	Price per ton May 1 (tame).	Price per ton Apr. 15 (wild).
1918.....	98,439,000	11.7	11,476,000
1917.....	110,992,000	11.4	12,659,000	\$14.44	\$10.94
1916.....	107,263,000	13.5	14,452,000	12.22	7.56
1915.....	88,686,000	12.2	10,797,000	11.82	8.58
1914.....	79,179,000	12.2	9,631,000	12.32
1913.....	99,734,000	14.9	13,523,000	11.13
1912.....	67,071,000	8.5	5,732,000	17.64
1911.....	82,529,000	12.4	10,222,000	12.29
1910.....	87,216,000	11.5	10,053,000	12.21

TABLE 105.—Hay: Farm price per ton on 1st of each month, 1909–1918.

Date.	1918	1917	1916	1915	1914	1913	1912	1911	1910	1909	Average.
Jan. 1.....	\$18.09	\$10.86	\$10.07	\$10.47	\$11.70	\$11.11	\$13.75	\$11.69	\$10.45	\$9.09	\$11.76
Feb. 1.....	18.88	11.34	10.55	10.83	11.67	10.86	14.39	11.80	11.34	9.27	12.09
Mar. 1.....	19.14	11.54	10.75	10.89	11.69	10.61	14.66	11.57	11.61	9.47	12.19
Apr. 1.....	18.68	12.53	10.85	10.98	11.52	10.43	15.64	11.36	11.53	9.65	12.32
May 1.....	17.97	13.94	11.27	11.03	11.63	10.42	16.31	11.69	11.08	10.12	12.55
June 1.....	17.13	14.68	11.47	11.16	11.64	10.55	16.22	12.38	10.84	10.70	12.68
July 1.....	16.07	13.96	11.10	10.85	11.29	10.47	14.32	13.19	10.75	10.50	12.25
Aug. 1.....	15.92	12.90	9.89	10.19	10.76	10.43	12.03	13.83	10.75	9.74	11.64
Sept. 1.....	17.42	13.26	9.72	9.95	11.10	11.04	11.21	13.63	11.21	9.67	11.82
Oct. 1.....	18.45	13.83	9.65	9.83	10.96	11.45	11.02	13.53	11.12	10.03	11.99
Nov. 1.....	19.27	15.16	9.99	9.98	10.78	11.51	11.08	13.61	11.20	10.35	12.29
Dec. 1.....	20.04	17.09	11.22	10.63	11.12	12.43	11.79	14.29	12.14	10.50	13.12
Average.....	18.18	13.53	10.48	10.50	11.28	11.02	13.24	12.83	11.21	9.93	12.22

HAY—Continued.

TABLE 106.—Hay: Wholesale price (baled) per ton, 1913–1918.

Date.	Chicago.			Cincinnati.			St. Louis.			New York.			San Francisco.		
	No. 1 timothy.			No. 1 timothy.			No. 1 timothy.			No. 1 timothy.			No. 1 wheat; light bales.		
	Low.	High.	Average.	Low.	High.	Average.	Low.	High.	Average.	Low.	High.	Average.	Low.	High.	Average.
1913.															
Jan.–June	13.00	18.00	15.15	13.50	19.00	16.42	12.00	17.50	17.57	19.50	23.00	20.93			
July–Dec.	13.50	19.50	16.15	15.00	21.00	18.89	14.50	22.50	18.10	20.00	22.00	21.09			
1914.															
Jan.–June	13.50	17.50	15.62	17.50	21.00	18.91	15.00	23.00	19.24	19.50	23.00	21.34	13.00	21.00	
July–Dec.	13.00	18.50	15.79	17.50	21.50	19.06	14.50	22.50	18.53	18.50	25.00	21.61	11.00	14.00	
1915.															
Jan.–June	14.50	18.00	16.30	18.00	22.00	19.24	16.00	22.00	18.81	18.00	25.00	22.20	11.00	14.00	11.90
July–Dec.	12.00	21.00	16.36	13.00	23.00	19.02	12.00	24.00	16.16	24.00	31.50	26.07	13.00	18.00	15.64
1916.															
Jan.–June	14.50	20.00	17.27	18.00	24.00	20.76	14.00	21.00	17.95	24.00	31.00	27.19	14.50	19.00	17.03
July–Dec.	9.50	18.00	14.98	14.25	18.50	16.31	11.00	19.50	15.40	18.00	28.00	22.37	14.50	20.00	17.30
1917.															
January	15.00	16.00	15.44	15.00	17.00	16.19	15.00	17.50	16.21	18.00	22.00	20.85	19.00	21.00	20.08
February	15.00	16.50	15.40	15.00	16.00	15.62	14.50	17.50	15.96	20.00	22.00	21.25	20.00	23.00	21.09
March	15.00	16.50	15.75	15.00	18.00	16.75	15.50	21.00	17.89	20.00	23.00	21.61	22.00	28.00	25.11
April	16.00	21.50	18.74	17.00	21.50	19.12	18.00	25.00	21.63	21.00	23.00	21.51	29.00	35.00	31.39
May	19.00	22.00	20.03	18.00	21.50	19.42	19.00	23.00	21.81	21.00	24.00	22.74	30.00	35.00	33.60
June	17.50	20.00	18.71	17.00	19.00	18.31	17.50	22.00	20.24	22.00	24.00	22.38	20.00	31.00	27.42
Jan.–June	15.00	22.00	17.34	15.00	21.50	17.57	14.50	25.00	18.85	18.00	24.00	21.80	19.00	35.00	26.55
July	16.50	19.00	17.75	16.50	18.75	17.47	15.00	22.00	18.78	20.00	22.50	21.64	19.00	24.00	20.98
August	17.50	24.00	20.29	18.00	20.00	18.90	15.00	28.00	22.54	21.00	24.00	22.48	22.00	24.00	23.46
September	19.00	23.00	21.23	19.00	23.00	21.25	21.00	25.50	23.06	23.00	25.00	24.02	21.00	25.00	23.46
October	22.00	28.00	25.35	22.00	27.50	24.69	23.00	31.00	26.72	23.00	25.00	24.50	25.00	28.00	25.24
November	26.00	28.50	26.98	27.00	30.00	28.68	28.00	30.00	29.23	26.00	34.00	30.65	27.00	34.00	28.59
December	26.00	28.00	26.77	28.50	30.00	29.38	29.00	32.00	30.57	28.00	32.00	30.36	29.00	30.00	29.50
July–Dec.	16.50	28.50	23.06	16.50	30.00	23.40	15.00	32.00	25.15	20.00	34.00	25.61	19.00	34.00	25.20
1918.															
January	26.50	30.00	28.49	29.50	33.00	30.53	28.00	34.50	31.05	29.00	40.00	36.38	29.00	30.00	29.50
February	28.00	30.00	29.37	32.00	34.00	33.19	28.50	34.00	32.16	36.00	40.00	38.53	29.00	30.00	29.50
March	28.00	33.00	29.31	28.75	34.25	32.12	25.00	33.00	30.85	29.00	39.00	34.02	29.00	31.00	29.66
April	22.00	26.00	24.30	24.00	30.50	26.31	24.00	29.00	27.16	30.00	33.00	31.12	27.00	31.00	28.25
May	20.00	26.00	22.50	21.50	25.50	23.60	20.00	28.00	24.46	28.00	32.00	30.02	27.00	28.00	27.50
June	16.00	22.00	18.84	19.00	22.00	20.53	19.00	26.00	22.17	20.00	31.00	27.53	27.00	28.00	26.96
Jan.–June	16.00	33.00	25.47	19.00	34.25	27.71	19.00	34.50	27.98	20.00	40.00	32.93	27.00	31.00	28.56
July	17.00	28.00	24.13	21.50	27.00	23.44	23.00	29.00	25.84	27.00	28.00	27.50	25.00	28.00	25.88
August	23.00	30.00	28.65	24.00	30.50	27.15	25.00	32.00	29.87	27.00	32.00	31.04	26.00	27.00	26.50
September	29.00	35.00	32.23	30.25	32.50	31.50	26.00	35.00	33.42	31.00	41.50	34.41	26.00	27.00	26.50
October	25.00	33.00	30.41	32.00	34.50	32.98	27.00	35.00	30.75	36.00	48.00	41.52	26.00	30.00	27.98
November	29.00	31.00	30.14	25.50	30.00	30.84	26.00	32.00	29.75	33.00	38.00	35.02	28.00	30.00	29.00
December	29.00	31.00	30.38	27.00	29.50	28.94	29.00	32.00	31.26	30.00	38.00	35.12	24.00	30.00	28.24
July–Dec.	17.00	35.00	29.32	21.50	34.50	29.14	23.00	35.00	30.15	27.00	48.00	34.10	24.00	30.00	27.35

HAY—Continued.

TABLE 107.—Wild, salt, and prairie hay: Acreage, production, and value, 1912

[000 omitted.]*

State.	Acreage.	Production.	Farm value Dec. 1.	State.	Acreage.	Production.	Farm value Dec. 1.
	<i>Acres.</i>	<i>Tons.</i>	<i>Dollars.</i>		<i>Acres.</i>	<i>Tons.</i>	<i>Dollars.</i>
Maine.....	24	22	308	North Dakota...	2,115	1,904	25,704
New Hampshire.....	20	18	252	South Dakota.....	3,282	3,282	40,040
Vermont.....	13	13	182	Nebraska.....	2,588	2,277	41,214
Massachusetts.....	20	20	300	Kansas.....	1,012	607	11,108
Rhode Island.....	1	1	18	Kentucky.....	5	5	80
Connecticut.....	12	12	168	Tennessee.....	28	28	610
New York.....	50	50	650	Alabama.....	35	35	612
New Jersey.....	35	44	572	Mississippi.....	40	48	893
Pennsylvania.....	14	13	182	Louisiana.....	38	38	1,140
Delaware.....	10	12	180	Texas.....	212	159	3,800
Maryland.....	6	7	119	Oklahoma.....	540	302	5,617
Virginia.....	8	8	148	Arkansas.....	137	123	2,829
West Virginia.....	6	7	112	Montana.....	482	362	5,973
North Carolina.....	42	46	690	Wyoming.....	300	330	5,676
South Carolina.....	10	10	238	Colorado.....	451	422	7,420
Georgia.....	13	12	258	New Mexico.....	29	20	410
Florida.....	9	10	242	Arizona.....	13	13	195
Ohio.....	2	3	44	Utah.....	96	106	1,280
Indiana.....	60	72	1,030	Nevada.....	144	72	1,022
Illinois.....	85	110	1,925	Idaho.....	113	124	1,860
Michigan.....	40	42	445	Washington.....	26	35	760
Wisconsin.....	351	456	7,478	Oregon.....	176	176	3,168
Minnesota.....	1,700	1,955	26,002	California.....	182	173	3,287
Iowa.....	570	684	11,286	United States..	15,283	14,374	219,185
Missouri.....	138	104	1,768				

TABLE 108.—Wild, salt, and prairie hay: Acreage, production, and value, 1909–1918.

Year.	Acreage.	Yield per acre.	Production.	Farm price per ton.	Farm value.
	<i>Acres.</i>	<i>Tons.</i>	<i>Tons.</i>	<i>Dollars.</i>	<i>Dollars.</i>
1918.....	15,283,000	0.94	14,374,000	15.25	219,185,060
1917.....	16,212,000	.93	15,131,000	13.49	204,086,060
1916.....	16,635,000	1.19	19,800,000		
1915.....	16,796,000	1.27	21,343,000		
1914.....	16,752,000	1.11	18,615,000		
1913.....	16,341,000	.92	15,063,000		
1912.....	17,427,000	1.04	18,043,000		
1911.....	17,187,000	.71	12,155,000		
1910.....	17,187,000	.77	13,151,000		
1909 ¹	17,186,000	1.07	18,383,000		

¹ Census figures.

HAY—Continued.

TABLE 109.—*Timothy and clover hay: Farm price per ton, 15th of each month, 1914-1918.*

Date.	Timothy.					Clover.				
	1918	1917	1916	1915	1914	1918	1917	1916	1915	1914
Jan. 15.....	\$21.37	\$12.61	\$13.11	\$14.07	\$19.82	\$11.38	\$11.24	\$13.07
Feb. 15.....	22.25	12.91	13.39	14.28	21.11	11.65	11.41	13.36
Mar. 15.....	22.53	13.20	13.61	14.28	21.37	11.90	11.70	13.41
Apr. 15.....	21.47	14.26	14.00	14.53	19.68	13.06	11.87	13.65
May 15.....	20.40	15.31	14.50	14.74	\$13.46	18.30	13.94	12.52	13.79	\$12.53
June 15.....	18.55	15.76	14.71	14.33	13.67	16.54	14.22	12.46	12.78	12.36
July 15.....	17.61	14.68	12.97	13.43	13.06	15.73	12.95	10.84	11.65	11.85
Aug. 15.....	18.98	14.11	11.74	12.39	13.09	17.18	12.76	9.93	10.87	12.09
Sept. 15.....	20.85	14.89	11.57	12.32	13.54	19.27	13.79	10.01	10.82	12.44
Oct. 15.....	22.60	16.23	11.54	12.14	13.66	20.60	15.01	10.08	10.60	12.47
Nov. 15.....	22.93	18.33	12.03	12.24	13.69	21.13	17.14	10.46	10.59	12.70
Dec. 15.....	22.94	20.31	12.29	12.73	13.69	21.26	18.67	10.86	10.95	12.76

TABLE 110.—*Alfalfa and prairie hay: Farm price per ton, 15th of each month, 1914-1918.*

Date.	Alfalfa.					Prairie.				
	1918	1917	1916	1915	1914	1918	1917	1916	1915	1914
Jan. 15.....	\$21.27	\$12.79	\$9.89	\$9.48	\$15.39	\$8.58	\$7.38	\$7.65
Feb. 15.....	21.38	13.63	10.35	9.32	15.74	8.60	7.34	7.86
Mar. 15.....	20.82	14.68	10.74	9.79	15.47	9.32	7.39	8.03
Apr. 15.....	18.97	17.68	10.73	9.81	14.47	10.94	7.56	8.58
May 15.....	17.84	17.92	10.56	9.58	\$10.26	12.75	12.02	7.71	8.29	\$9.08
June 15.....	16.74	16.77	10.49	8.50	8.80	12.78	11.84	7.97	7.72	8.47
July 15.....	16.58	14.13	9.87	8.28	8.65	12.51	10.11	7.25	7.37	7.49
Aug. 15.....	18.22	15.28	9.80	8.28	8.38	13.26	10.82	6.96	6.83	7.29
Sept. 15.....	19.72	16.33	10.06	8.22	8.72	14.35	11.40	7.21	6.64	7.33
Oct. 15.....	20.23	17.59	10.25	8.14	8.96	15.06	12.29	7.26	6.44	7.59
Nov. 15.....	20.42	19.19	11.37	8.72	9.20	15.47	13.32	7.85	6.75	7.49
Dec. 15.....	20.74	20.39	12.31	9.52	9.05	16.30	14.91	8.14	6.95	7.37

CLOVER AND TIMOTHY SEED.

TABLE 111.—Clover seed: Acreage, production, and value, by States, 1918, and totals, 1916 and 1917.

State and year.	Acreage.	Average yield per acre.	Production.	Average farm price per bushel Dec. 1.	Farm value Dec. 1.
	<i>Acres.</i>	<i>Bushels.</i>	<i>Bushels.</i>	<i>Dollars.</i>	<i>Dollars.</i>
New York.....	5,000	2.8	14,000	18.00	252,000
Pennsylvania.....	12,000	1.3	16,000	19.00	304,000
Ohio.....	126,000	1.1	139,000	20.50	2,850,000
Indiana.....	135,000	1.3	176,000	19.80	3,485,000
Illinois.....	175,000	1.7	298,000	19.00	5,662,000
Michigan.....	93,000	1.3	121,000	20.60	2,493,000
Wisconsin.....	56,000	1.8	101,000	20.80	2,101,000
Minnesota.....	16,000	1.1	18,000	18.00	324,000
Iowa.....	16,000	1.4	22,080	19.90	438,000
Missouri.....	29,000	1.3	38,000	17.20	654,000
Nebraska.....	4,000	1.6	6,000	17.00	102,000
Kansas.....	6,000	1.3	8,000	17.00	136,000
Kentucky.....	23,000	1.5	34,000	19.60	666,000
Tennessee.....	6,000	2.0	12,000	18.00	216,000
Idaho.....	13,000	6.0	78,000	20.50	1,599,000
Oregon.....	7,000	3.0	21,000	24.00	504,000
Total.....	722,000	1.5	1,102,000	19.77	21,786,000
1917.....	821,000	1.8	1,488,000	12.84	19,107,000
1916.....	939,000	1.8	1,706,000	9.18	15,661,000

TABLE 112.—Clover seed: Farm price per bushel, 15th of each month, 1910–1918.

Date.	1918	1917	1916	1915	1914	1913	1912	1911	1910
Jan. 15.....	\$14.48	\$9.60	\$10.27	\$8.51	\$7.99	\$9.41	\$10.89	\$8.27	\$8.26
Feb. 15.....	16.46	9.87	10.47	8.60	8.07	10.28	12.22	8.37	8.26
Mar. 15.....	17.49	10.32	10.76	8.55	8.17	10.42	12.89	8.56	8.15
Apr. 15.....	17.86	10.41	10.58	8.36	8.06	11.00	12.91	8.79	7.91
May 15.....	16.56	10.40	9.98	8.14	7.87	10.74	12.53	8.74	7.47
June 15.....	15.88	10.29	9.47	7.90	7.96	9.77	11.69	8.80	7.24
July 15.....	14.71	10.50	9.15	7.96	8.12	9.78	10.64	8.83	7.17
Aug. 15.....	15.20	10.53	9.12	7.94	8.76	9.37	9.80	9.65	7.53
Sept. 15.....	16.61	10.89	8.65	8.49	9.10	7.31	9.39	10.19	8.27
Oct. 15.....	19.01	11.92	8.54	9.70	8.24	7.00	9.37	10.33	8.13
Nov. 15.....	20.03	12.91	9.20	9.67	8.02	7.33	9.06	10.37	7.70
Dec. 15.....	20.67	13.53	9.40	10.01	8.12	7.70	9.00	10.62	7.94

TABLE 113.—Timothy seed: Farm price per bushel, 15th of each month, 1910–1918.

Date.	1918	1917	1916	1915	1914	1913	1912	1911	1910
Jan. 15.....	\$3.57	\$2.44	\$3.05	\$2.63	\$2.07	\$1.79	\$6.99	\$4.12
Feb. 15.....	3.78	2.46	3.19	2.66	2.12	1.78	7.26	4.51
Mar. 15.....	3.84	2.70	3.28	2.78	2.30	1.72	7.33	4.93
Apr. 15.....	3.74	2.76	3.51	2.69	2.28	1.74	7.27	5.17
May 15.....	3.84	3.09	3.33	2.75	2.38	1.76	7.16	5.24
June 15.....	3.56	3.09	3.26	2.65	2.23	1.77	6.68	5.24
July 15.....	3.67	3.04	3.08	2.57	2.32	1.94	5.96	5.48
Aug. 15.....	3.87	3.23	2.36	2.56	2.43	2.01	3.20	6.52
Sept. 15.....	3.79	3.31	2.22	2.62	2.46	2.13	2.09	6.65	\$3.77
Oct. 15.....	4.08	3.61	2.27	2.72	2.34	2.02	1.95	6.91	4.03
Nov. 15.....	4.26	3.25	2.25	2.91	2.34	2.08	1.82	6.90	4.08
Dec. 15.....	4.21	3.37	2.31	2.86	2.18	2.10	1.79	6.72	4.11

CLOVER AND TIMOTHY SEED—Continued.

TABLE 114.—Clover and timothy seed: Wholesale price, 1913-1918.

Date.	Clover (bushels of 60 pounds).												Timothy.											
	Cincinnati.			Chicago.			Toledo.			Detroit.			Cincinnati.			Chicago.			Milwaukee.			St. Louis.		
	Prime.			Poor to prime.			Poor to choice.						Per bushel (of 45 pounds).			Poor to choice (per 100 pounds).			Per 100 pounds.			Poor to prime (per 100 pounds).		
	Low.	High.	Average.	Low.	High.	Average.	Low.	High.	Average.	Low.	High.	Average.	Low.	High.	Average.	Low.	High.	Average.	Low.	High.	Average.	Low.	High.	Average.
1913.																								
Jan.-June.....	Dolls. 8.00	Dolls. 11.50	Dolls. 9.34	Dolls. 5.00	Dolls. 22.00	Dolls. 14.51	Dolls. 7.50	Dolls. 13.85	Dolls. 12.30	Dolls. 11.15	Dolls. 13.40	Dolls. 1.50	Dolls. 1.80	Dolls. 1.65	Dolls. 2.50	Dolls. 5.35	Dolls. 3.04	Dolls. 2.50	Dolls. 4.60	Dolls. 3.23	Dolls. 2.00	Dolls. 3.75	Dolls. 2.82
July-Dec.....	5.00	9.00	6.34	7.00	16.00	10.43	6.80	12.75	9.11	7.50	9.45	1.50	2.25	1.94	3.50	5.90	4.65	3.50	5.50	4.61	2.25	5.50	4.30
1914.																								
Jan.-June.....	5.00	9.00	6.95	7.00	15.00	11.03	7.25	9.47	8.26	7.40	9.40	1.40	2.25	1.80	2.50	5.75	4.34	3.00	5.50	4.02	2.25	5.35	4.07
July-Dec.....	5.00	9.25	7.30	9.00	18.50	12.68	8.20	11.15	9.32	8.20	11.25	1.40	2.70	2.16	3.50	7.25	5.03	3.20	6.50	4.72	3.25	7.00	5.20
1915.																								
Jan.-June.....	6.50	9.65	8.01	7.00	14.75	10.81	7.25	9.55	8.18	7.85	9.60	8.52	2.00	3.60	2.84	4.00	7.00	5.63	4.50	7.00	5.51	3.00	7.00
July-Dec.....	6.50	12.20	8.86	7.00	20.50	13.12	7.40	13.10	10.42	7.70	12.55	10.62	1.90	3.75	2.75	4.50	8.00	6.11	4.50	8.00	6.05	3.00	7.50
1916.																								
Jan.-June.....	6.50	11.50	8.69	6.00	22.00	12.54	8.30	13.65	10.64	8.75	13.25	10.70	1.80	3.30	2.54	4.00	8.50	6.30	4.00	8.50	6.28	3.75	7.50	6.10
July-Dec.....	6.50	10.00	8.57	6.00	18.00	12.02	8.40	11.15	9.94	8.60	11.00	9.88	1.20	2.80	1.69	3.00	7.50	4.45	3.50	8.00	4.96	3.00	6.80	4.63
1917.																								
January.....	8.75	10.20	9.43	12.00	18.35	15.04	10.62	11.02½	10.87	10.65	11.00	10.81	1.30	2.00	1.59	3.00	5.50	4.25	4.00	5.75	4.92	4.15	4.75	4.44
February.....	9.00	11.00	9.81	12.00	19.90	15.64	10.90	11.97½	11.82	10.75	11.80	11.45	1.60	2.00	1.80	3.00	5.50	4.25	4.65	5.50	5.11	3.50	5.00	4.40
March.....	8.50	11.00	10.10	12.00	19.65	15.16	10.00	11.80	11.17	10.75	11.80	11.16	1.60	2.10	1.82	3.00	5.75	4.21	4.60	5.75	5.05	3.90	5.00	4.60
April.....	8.00	10.25	8.84	12.00	18.25	14.79	10.50	10.85	10.62	10.60	10.90	10.66	1.65	2.50	2.00	3.00	8.00	4.82	4.75	7.75	6.04	4.15	6.50	5.34
May.....	8.40	10.60	9.38	12.00	18.75	15.06	10.60	11.25	10.87	10.70	11.10	10.88	2.50	3.35	2.94	4.00	8.40	6.56	6.75	8.40	7.57	5.50	7.60	7.03
June.....	9.20	10.60	9.90	12.00	18.75	15.09	10.75	11.20	10.94	10.80	11.20	10.92	2.65	3.35	3.00	7.00	8.25	6.28	6.50	8.40	7.40	6.00	7.60	6.94
Jan.-June.....	8.00	11.00	9.58	12.00	19.90	15.13	10.00	11.97½	11.05	10.60	11.80	10.98	1.30	3.35	2.19	3.00	8.40	5.06	4.00	8.40	6.02	3.50	7.60	5.46
July.....	9.20	10.60	9.82	12.00	20.00	15.72	10.95	12.00	11.50	10.80	11.85	11.37	2.60	3.35	2.95	4.00	8.50	5.83	6.75	8.00	7.28	6.00	7.50	6.72
August.....	9.50	11.50	10.32	14.00	21.50	17.14	11.00	13.00	11.93	11.90	12.50	11.90	2.75	3.50	3.09	4.00	8.50	6.58	7.00	8.50	7.69	6.50	8.25	7.55
September.....	10.25	12.85	11.62	15.00	26.00	19.29	12.75	13.60	13.28	12.75	13.80	13.18	2.90	3.30	3.22	6.00	8.00	6.94	6.50	8.00	7.51	7.00	8.00	7.52

October.....	10.65	13.10	12.19	17.00	25.65	20.73	13.50	15.25	14.70	13.50	15.25	14.63	2.50	3.15	2.82	5.50	8.50	7.05	6.50	8.50	7.44	6.75	7.60	7.21
November.....	11.60	14.60	13.16	18.00	28.00	23.68	15.25	16.35	16.05	15.35	18.00	15.82	2.50	3.00	2.78	5.00	7.75	6.19	6.25	7.50	6.97	6.50	7.40	6.85
December.....	12.00	16.00	13.50	26.00	28.00	27.17	15.00	15.00	15.00	16.00	16.50	16.18	2.50	3.00	2.75	5.00	7.50	6.11	6.50	7.75	7.19	6.40	7.25	6.89
July-Dec.....	9.20	16.00	11.77	12.00	28.00	20.62	10.95	16.35	13.74	10.80	16.50	13.86	2.50	3.50	2.88	4.00	8.50	6.45	6.25	8.50	7.35	6.00	8.25	7.12
1918.																								
January.....	12.50	16.75	14.48	19.00	33.50	25.48	16.50	19.90	18.40	16.50	19.85	18.36	2.50	3.65	2.98	5.00	8.25	6.52	5.00	8.25	6.53	6.75	7.80	7.46
February.....	14.00	19.75	16.07	20.00	35.00	27.47	19.40	20.80	20.23	19.75	20.65	20.15	3.00	3.70	3.32	5.00	8.25	6.62	5.00	8.25	6.62	7.15	7.88	7.57
March.....	14.00	19.00	16.50	20.00	31.00	25.48	18.75	20.75	20.14	19.65	20.50	20.11	3.00	3.50	3.20	5.00	8.25	6.68	5.00	8.25	6.60	6.85	7.50	7.21
April.....	13.50	18.50	16.12	18.00	31.00	24.08	18.25	20.20	18.88	19.00	20.00	19.40	2.90	3.40	3.12	5.00	8.25	6.51	5.00	8.25	6.50	7.10	7.60	7.25
May.....	13.00	18.50	15.40	18.00	28.00	23.00	18.00	18.25	18.22	18.50	19.00	18.59	2.90	3.30	3.10	5.00	8.00	6.52	5.00	8.25	6.53	6.50	7.35	7.05
June.....	11.00	17.50	14.00	18.00	28.00	23.00	13.00	18.25	16.92	16.00	18.25	17.24	2.90	3.30	3.10	5.00	8.00	6.32	5.00	8.00	6.32	6.50	7.25	6.76
Jan.-June.....	11.00	19.75	15.43	18.00	35.00	24.75	13.00	20.80	18.80	16.00	20.65	18.98	2.50	3.70	3.14	5.00	8.25	6.51	5.00	8.25	6.52	6.50	7.88	7.22
July.....	11.00	15.00	12.94	15.50	17.60	16.41	16.00	16.75	16.26	2.90	3.80	3.10	5.00	8.50	6.48	5.00	8.50	6.63	6.50	8.75	7.68
August.....	11.00	18.00	15.25	16.80	18.75	17.54	16.75	18.50	17.85	2.90	4.25	3.65	5.00	9.00	7.38	6.00	9.00	7.58	8.00	9.50	8.69
September.....	14.00	16.50	15.19	15.00	35.00	27.70	19.05	23.60	21.60	18.50	22.75	21.35	3.75	4.25	4.00	6.00	10.00	8.45	6.50	10.00	8.26	9.00	9.75	9.35
October.....	18.00	21.50	19.80	25.00	35.00	30.06	22.55	24.00	23.02	22.50	23.25	22.61	4.00	4.60	4.32	7.00	10.00	8.50	7.00	10.00	8.50	9.00	9.75	9.37
November.....	16.00	22.00	20.00	25.00	38.00	30.44	23.90	25.90	24.94	23.25	25.25	24.62	4.00	5.00	4.51	7.00	11.00	8.72	7.00	11.00	8.65	9.75	10.50	9.37
December.....	16.00	22.00	19.50	25.00	38.00	30.88	24.50	26.00	25.39	24.30	25.75	24.93	4.00	4.80	4.45	8.00	11.00	9.50	8.00	11.00	9.50	9.10	10.25	9.68
July-Dec.....	11.00	22.00	17.11	15.00	38.00	29.77	15.50	26.00	21.48	16.00	25.75	21.27	2.90	5.00	4.00	5.00	11.00	8.17	5.00	11.00	8.19	6.50	10.50	9.02

COTTON.

TABLE 115.—Cotton: Area and production of undermentioned countries, 1915–1917.

[Bales of 478 pounds net.]

Country.	Area.			Production.		
	1915	1916	1917	1915	1916	1917
NORTH AMERICA.						
United States ¹	<i>Acres.</i> 31,412,000	<i>Acres.</i> 34,985,000	<i>Acres.</i> 33,841,000	<i>Bales.</i> 11,192,000	<i>Bales.</i> 11,450,000	<i>Bales.</i> 11,302,000
Porto Rico ²				739	379	268
St. Croix.....			29			16
West Indies:						
British—						
Barbados ³				648	299	1
Grenada ³				772		24
Jamaica ³				88		
Leeward Islands.....				4,413		
St. Lucia ³				7		
St. Vincent ³				791		
Dominican Republic.....				736	270	
SOUTH AMERICA.						
Argentina.....	8,154	9,118				
Brazil.....				440,000	420,000	
Peru ³		137,474		97,429	113,472	
EUROPE.						
Bulgaria.....	4,730					
Malta.....	946	817		384	331	
ASIA.						
British India ⁵	17,746,000	21,745,000	24,781,000	3,128,000	3,767,000	3,377,000
Ceylon.....	152					
Cyprus.....				5,619		
Dutch East Indies.....				18,966		
Indo-China ⁶				93		
Japanese Empire:						
Japan.....	6,565	5,685		4,840	4,360	
Korea.....	160,033			41,516	28,901	52,189
Russia, Asiatic:						
Transcaucasia.....	291,568	233,254		132,649		
Central Asia.....	1,833,185	1,900,349	1,147,000	1,525,929	1,101,489	
Total.....	2,124,753	2,133,603		1,658,578		
Siam.....				4,694		
AFRICA.						
British Africa:						
Lagos.....				5,188	7,782	
Nyasaland Protectorate.....	24,006	29,850		6,413	7,244	
East Africa Protectorate.....				251	167	
Gold Coast.....				80	80	
Nigeria, Northern.....				1,004	9,038	
Nigeria, Southern.....				84	84	
Uganda Protectorate.....	92,127			20,837		
Union of South Africa ³				243	267	
Egypt.....	1,231,000	1,719,000	1,741,000	989,000	1,062,000	1,347,000
French Africa:						
Dahomey ³				315		
Guinea.....				468		
Ivory Coast ³				437		
German Africa:						
East Africa.....				10,109		
Togo.....				2,322		
Italian Africa:						
Eritrea ³				59		
Sudan (Anglo-Egyptian).....				20,084	13,556	
OCEANIA.						
British:						
Fiji.....				8		
Queensland.....				13		
Solomon Islands.....				24		
French:						
New Caledonia ³				2,124		

¹Linters not included. Quantity of linters produced, 931,141 bales in 1915, 1,330,714 bales in 1916, and 1,130,997 bales in 1917.²Shipments to the United States plus exports to foreign countries.³Exports.⁴1914 figures.⁵Includes native States.⁶1913 figures.

COTTON—Continued.

TABLE 116.—Cotton: Total production of countries for which estimates were available, 1900—1915.

Year.	Production.	Year.	Production.	Year.	Production.	Year.	Production.
1900.....	<i>Bales.¹</i> 15,893,591	1904.....	<i>Bales.¹</i> 21,005,175	1908.....	<i>Bales.¹</i> 23,688,292	1912.....	<i>Bales.¹</i> 19,578,095
1901.....	15,926,048	1905.....	18,342,075	1909.....	20,679,334	1913.....	21,271,902
1902.....	17,331,503	1906.....	22,183,148	1910.....	22,433,269	1914.....	23,804,422
1903.....	17,278,881	1907.....	18,328,613	1911.....	21,754,810	1915.....	17,659,126

¹ Bales of 478 pounds, net weight.

TABLE 117.—Cotton: Acreage, production, value, exports, etc., in the United States, 1866—1918.

Year.	Acreage.	Average yield per acre.	Production.	Average farm price per pound Dec. 1.	Farm value Dec. 1.	New York closing prices, per pound, on middling upland.				Domestic exports, fiscal year beginning July 1.
						December		May of following year.		
						Low.	High.	Low.	High.	
	<i>Acres.</i>	<i>Pounds.</i>	<i>Bales.</i>	<i>Cents.</i>	<i>Dollars.</i>	<i>Cts.</i>	<i>Cts.</i>	<i>Cts.</i>	<i>Cts.</i>	<i>Bales.¹</i>
1866.....	7,599,000	129.0	1,758,000	33 ¹ / ₂	34 ¹ / ₂	27 ¹ / ₂	28 ¹ / ₂	1,322,947
1867.....	7,828,000	189.8	2,340,000	15 ¹ / ₂	17 ¹ / ₂	30 ¹ / ₂	32 ¹ / ₂	1,569,527
1868.....	6,799,000	192.2	2,380,000	24 ¹ / ₂	25 ¹ / ₂	28 ¹ / ₂	28 ¹ / ₂	1,288,656
1869.....	7,743,000	196.9	3,012,000	25	25 ¹ / ₂	22 ¹ / ₂	23 ¹ / ₂	1,917,117
1870.....	8,885,000	198.9	3,800,000	15	15 ¹ / ₂	14 ¹ / ₂	17 ¹ / ₂	2,925,856
1871.....	7,558,000	148.2	2,553,000	19 ¹ / ₂	20 ¹ / ₂	23 ¹ / ₂	26 ¹ / ₂	1,867,075
1872.....	8,483,000	188.7	3,920,000	19 ¹ / ₂	20 ¹ / ₂	19 ¹ / ₂	19 ¹ / ₂	2,400,127
1873.....	9,510,000	179.7	3,683,000	15 ¹ / ₂	16 ¹ / ₂	17 ¹ / ₂	18 ¹ / ₂	2,717,205
1874.....	11,764,000	147.5	3,941,000	14 ¹ / ₂	14 ¹ / ₂	16 ¹ / ₂	16 ¹ / ₂	2,520,838
1875.....	11,934,000	190.6	5,123,000	13 ¹ / ₂	13 ¹ / ₂	11 ¹ / ₂	11 ¹ / ₂	2,982,811
1876.....	11,677,000	167.8	4,438,000	9.0	174,724,000	12 ¹ / ₂	12 ¹ / ₂	16 ¹ / ₂	11 ¹ / ₂	2,890,738
1877.....	12,133,000	163.8	4,370,000	11 ¹ / ₂	11 ¹ / ₂	10 ¹ / ₂	11 ¹ / ₂	3,215,067
1878.....	12,344,000	191.2	5,244,000	8.2	192,515,000	8 ¹ / ₂	9 ¹ / ₂	11 ¹ / ₂	13 ¹ / ₂	3,256,746
1879.....	14,480,000	181.0	5,755,000	10.3	269,305,000	12 ¹ / ₂	13 ¹ / ₂	11 ¹ / ₂	11 ¹ / ₂	3,644,363
1880.....	15,951,000	184.5	6,343,000	9.8	289,083,000	11 ¹ / ₂	12	10 ¹ / ₂	10 ¹ / ₂	4,382,009
1881.....	16,711,000	149.8	5,456,000	11 ¹ / ₂	12 ¹ / ₂	12 ¹ / ₂	12 ¹ / ₂	3,480,792
1882.....	16,277,000	185.7	6,957,000	9.1	275,513,000	10 ¹ / ₂	10 ¹ / ₂	10 ¹ / ₂	11 ¹ / ₂	4,576,738
1883.....	16,778,000	164.8	5,701,000	9.1	250,977,000	10 ¹ / ₂	10 ¹ / ₂	11 ¹ / ₂	11 ¹ / ₂	3,725,145
1884.....	17,440,000	153.8	5,682,000	9.2	246,575,000	10 ¹ / ₂	11 ¹ / ₂	10 ¹ / ₂	11 ¹ / ₂	3,783,319
1885.....	18,301,000	164.4	6,575,000	8.4	251,775,000	9 ¹ / ₂	9 ¹ / ₂	9 ¹ / ₂	9 ¹ / ₂	4,116,149
1886.....	18,455,000	169.5	6,446,000	8.1	251,856,000	9 ¹ / ₂	9 ¹ / ₂	10 ¹ / ₂	11 ¹ / ₂	4,338,915
1887.....	18,641,000	182.7	7,020,000	8.5	290,901,000	10 ¹ / ₂	10 ¹ / ₂	9 ¹ / ₂	10 ¹ / ₂	4,528,883
1888.....	19,059,000	180.4	6,941,000	8.5	292,139,000	9 ¹ / ₂	9 ¹ / ₂	11 ¹ / ₂	11 ¹ / ₂	4,770,065
1889.....	20,175,000	159.7	7,473,000	8.5	275,249,000	10 ¹ / ₂	10 ¹ / ₂	11 ¹ / ₂	12 ¹ / ₂	4,943,925
1890.....	19,512,000	187.0	8,674,000	8.6	313,360,000	9 ¹ / ₂	9 ¹ / ₂	8 ¹ / ₂	8 ¹ / ₂	5,814,718
1891.....	19,059,000	179.4	9,018,000	7.2	247,633,000	7 ¹ / ₂	8 ¹ / ₂	7 ¹ / ₂	7 ¹ / ₂	5,870,440
1892.....	15,911,000	209.2	6,664,000	8.3	277,194,000	9 ¹ / ₂	10	7 ¹ / ₂	7 ¹ / ₂	4,424,230
1893.....	19,525,000	149.9	7,493,000	7.0	204,983,000	7 ¹ / ₂	8 ¹ / ₂	7 ¹ / ₂	7 ¹ / ₂	5,036,565
1894.....	23,688,000	195.3	9,476,000	4.6	212,335,000	5 ¹ / ₂	5 ¹ / ₂	6 ¹ / ₂	7 ¹ / ₂	7,034,866
1895.....	20,185,000	155.6	7,161,000	7.6	238,503,000	8 ¹ / ₂	8 ¹ / ₂	8	8 ¹ / ₂	4,670,453
1896.....	23,273,000	184.9	8,533,000	6.7	286,169,000	7 ¹ / ₂	7 ¹ / ₂	7 ¹ / ₂	7 ¹ / ₂	6,207,510
1897.....	24,320,000	182.7	10,898,000	6.7	296,816,000	5 ¹ / ₂	5 ¹ / ₂	6 ¹ / ₂	6 ¹ / ₂	7,725,572
1898.....	24,967,000	220.6	11,189,000	5.7	315,449,000	5 ¹ / ₂	5 ¹ / ₂	6 ¹ / ₂	6 ¹ / ₂	7,575,438
1899.....	24,327,000	183.8	9,845,000	7.0	326,215,000	7 ¹ / ₂	7 ¹ / ₂	9	9 ¹ / ₂	6,252,451
1900.....	24,933,000	194.4	10,123,000	9.2	463,310,000	9 ¹ / ₂	10 ¹ / ₂	8 ¹ / ₂	8 ¹ / ₂	6,718,125
1901.....	26,774,000	170.0	9,510,000	7.0	334,088,000	8	8 ¹ / ₂	9 ¹ / ₂	9 ¹ / ₂	7,057,949
1902.....	27,175,000	187.3	10,631,000	7.6	403,718,000	8 ¹ / ₂	8 ¹ / ₂	10.75	12.15	7,138,284
1903.....	27,052,000	174.3	9,851,000	10.5	516,763,000	11.95	14.10	12.75	13.90	6,179,712
1904.....	31,215,000	205.9	13,438,000	9.0	603,438,000	6.85	9.00	7.85	8.85	8,678,644
1905.....	27,110,000	186.6	10,575,000	10.8	569,791,000	11.65	12.60	11.25	12.00	7,268,000
1906.....	31,374,000	202.5	13,274,000	9.6	635,534,000	10.45	11.25	11.60	12.90	9,036,434
1907.....	29,660,000	179.1	11,107,000	10.4	575,226,000	11.70	12.20	10.20	11.50	7,633,997
1908.....	32,444,000	194.9	13,242,000	8.7	575,092,000	9.10	9.35	10.85	11.80	8,895,970
1909.....	30,938,000	154.3	10,005,000	13.9	697,681,000	14.65	16.15	14.50	16.05	6,413,416
1910.....	32,403,000	170.7	11,609,000	14.1	820,407,000	14.80	15.25	15.35	16.15	8,067,882
1911.....	36,045,000	207.7	15,693,000	8.8	687,888,000	9.20	9.65	11.30	11.90	11,070,251
1912.....	34,283,000	190.9	13,708,000	11.9	817,055,000	12.75	13.20	11.80	12.10	9,124,591
1913.....	37,089,000	182.0	14,156,000	12.2	862,708,000	12.50	13.50	12.90	14.50	9,521,881
1914.....	36,832,000	209.2	16,135,000	6.8	549,036,000	7.25	7.80	9.50	10.40	8,807,157
1915.....	31,412,000	170.3	11,192,000	11.3	631,460,000	11.95	12.75	12.30	13.35	6,168,140
1916.....	34,985,000	156.6	11,450,000	19.6	1,122,295,000	16.20	20.30	19.60	22.10	5,947,165
1917.....	33,841,000	159.7	11,302,000	27.7	1,566,198,000	29.85	31.85	25.70	30.10	4,528,844
1918.....	35,890,000	155.9	11,700,000	27.6	1,616,207,000	27.50	33.00

¹ Bales of 500 pounds, gross weight.

COTTON—Continued.

TABLE 118.—Cotton: Acreage harvested, by States, 1909–1918.

[Thousands of acres.]

State.	1909	1910	1911	1912	1913	1914	1915	1916	1917	1918
Virginia.....	25	33	43	47	47	45	34	42	50	46
North Carolina.....	1,359	1,478	1,624	1,545	1,576	1,527	1,282	1,451	1,515	1,565
South Carolina.....	2,492	2,534	2,800	2,695	2,790	2,861	2,516	2,780	2,837	3,047
Georgia.....	4,674	4,873	5,504	5,335	5,318	5,433	4,825	5,277	5,195	5,338
Florida.....	237	257	308	224	188	221	193	191	183	154
Alabama.....	3,471	3,560	4,017	3,730	3,760	4,007	3,340	3,225	1,977	2,451
Mississippi.....	3,291	3,317	3,340	2,889	3,067	3,054	2,735	3,110	2,788	3,132
Louisiana.....	930	975	1,075	929	1,244	1,299	990	1,250	1,454	1,560
Texas.....	9,660	10,060	10,943	11,338	12,597	11,931	10,510	11,400	11,092	11,235
Arkansas.....	2,218	2,238	2,363	1,991	2,502	2,480	2,170	2,600	2,740	2,888
Tennessee.....	735	765	837	783	865	915	772	887	882	940
Missouri.....	79	100	129	103	112	145	96	133	153	156
Oklahoma.....	1,767	2,204	3,050	2,665	3,009	2,847	1,895	2,562	2,783	3,095
California.....		9	12	9	14	47	39	52	136	181
Arizona.....									41	87
All other.....						20	15	25	15	15
United States..	30,938	32,403	36,045	34,283	37,089	36,832	31,412	34,985	33,841	35,890

TABLE 119.—Cotton: Production of lint (excluding linters) in 500-pound gross weight bales, by States, 1909 to 1918.

[Thousands of bales, as finally reported by U. S. Bureau of the Census.]

State.	1909	1910	1911	1912	1913	1914	1915	1916	1917	1918
Virginia.....	10	15	30	24	23	25	16	27	19	26
North Carolina.....	601	706	1,076	866	792	931	699	655	618	870
South Carolina.....	1,100	1,164	1,649	1,182	1,378	1,534	1,134	932	1,237	1,500
Georgia.....	1,804	1,767	2,769	1,777	2,317	2,718	1,909	1,821	1,884	2,100
Florida.....	54	59	83	53	59	81	48	41	38	25
Alabama.....	1,024	1,194	1,716	1,342	1,495	1,751	1,021	533	518	820
Mississippi.....	1,083	1,263	1,204	1,046	1,311	1,246	954	812	905	1,210
Louisiana.....	253	246	385	376	444	449	341	443	639	525
Texas.....	2,523	3,049	4,256	4,880	3,945	4,592	3,227	3,726	3,125	2,580
Arkansas.....	714	821	939	792	1,073	1,016	816	1,134	974	935
Tennessee.....	247	332	450	277	379	384	303	382	240	330
Missouri.....	45	60	97	56	67	82	48	63	61	70
Oklahoma.....	545	923	1,022	1,021	840	1,262	640	823	959	550
California.....		6	10	8	23	50	29	44	58	100
Arizona.....									22	51
All other.....	2	4	7	3	10	14	7	14	5	8
United States..	10,005	11,609	15,693	13,703	14,156	16,135	11,192	11,450	11,302	11,700

TABLE 120.—Cotton: Condition of crop, United States, monthly, 1897–1918.

[Prior to 1911 figures of condition relate to first month following dates indicated.]

Year.	May 25.	June 25.	July 25.	Aug. 25.	Sept. 25.	Year.	May 25.	June 25.	July 25.	Aug. 25.	Sept. 25.
1897.....	P. ct. 83.5	P. ct. 86.0	P. ct. 86.9	P. ct. 78.3	P. ct. 70.0	1908.....	P. ct. 79.7	P. ct. 81.2	P. ct. 83.0	P. ct. 76.1	P. ct. 69.7
1898.....	89.0	91.2	91.2	79.8	75.4	1909.....	81.1	74.6	71.9	63.7	58.5
1899.....	85.7	87.8	84.0	68.5	62.4	1910.....	82.0	80.7	75.5	72.1	65.9
1900.....	82.5	75.8	76.0	68.2	67.0	1911.....	87.8	88.2	89.1	73.2	71.1
1901.....	81.5	81.1	77.2	71.4	61.4	1912.....	78.9	80.4	76.5	74.8	69.6
1902.....	95.1	84.7	81.9	64.0	58.3	1913.....	79.1	81.8	79.6	68.2	64.1
1903.....	74.1	77.1	79.7	81.2	65.1	1914.....	74.3	79.6	76.4	78.0	73.5
1904.....	83.0	88.0	91.6	84.1	75.8	1915.....	80.0	80.2	75.4	69.2	60.8
1905.....	77.2	77.0	74.9	72.1	71.2	1916.....	77.5	81.1	72.3	61.2	56.3
1906.....	84.6	83.3	82.9	77.3	71.6	1917.....	69.5	70.3	70.3	67.8	60.4
1907.....	70.5	72.0	75.0	72.7	67.7	1918.....	82.3	85.8	73.6	55.7	54.4

COTTON—Continued.

TABLE 121.—Cotton: Yield per acre, price per pound Dec. 1, and value per acre, by States.

State.	Yield per acre (pounds of lint).											Farm price per pound (cents).					Value per acre (dollars). ¹		
	10-year average, 1900-1918.	1909	1910	1911	1912	1913	1914	1915	1916	1917	1918	10-year average, 1909-1918.	1914	1915	1916	1917	1918	5-year average, 1914-1917.	1918
Va...	247	190	212	330	250	240	265	225	310	180	270	15.4	7.3	11.4	19.4	27.8	26.5	45.34	71.55
N. C...	248	210	227	315	267	239	290	260	215	194	265	15.3	6.9	11.2	19.4	27.7	26.4	42.91	69.96
S. C...	222	210	216	280	209	235	255	215	160	208	235	15.6	6.9	11.3	19.6	28.4	27.6	39.44	64.86
Ga...	192	184	173	240	159	208	239	189	165	173	188	15.7	6.9	11.4	19.9	28.8	27.5	34.48	51.70
Fla...	119	110	110	130	113	150	175	120	105	100	78	23.6	12.2	14.8	31.0	50.5	43.0	31.14	33.54
Ala...	159	142	160	204	172	190	209	146	79	125	160	15.4	6.7	11.1	19.5	28.0	27.0	24.76	43.20
Miss...	172	157	182	172	173	204	195	167	125	155	185	15.8	6.8	11.5	20.5	28.5	27.8	30.74	51.43
La...	165	130	120	170	193	170	165	165	170	210	161	15.2	6.9	11.2	19.1	26.7	27.5	32.95	44.28
Tex...	154	125	145	186	206	150	184	147	157	135	110	15.1	6.8	11.1	19.4	26.7	28.2	25.27	31.02
Ark...	182	153	175	190	190	205	196	180	209	170	155	15.5	6.6	11.6	19.6	28.2	27.8	33.16	43.09
Tenn.	189	158	207	257	169	210	200	188	206	130	168	15.3	6.4	11.3	19.5	27.3	26.7	30.91	44.86
Mo...	260	271	285	360	280	286	270	240	225	190	215	14.9	6.5	11.0	19.0	27.5	27.0	39.40	58.05
Okla...	160	147	200	160	183	132	212	162	154	165	85	14.6	6.5	11.3	19.0	26.5	25.5	25.35	21.68
Calif...	385	335	390	450	500	500	380	400	242	265	15.8	7.0	11.2	20.0	28.0	30.0	60.96	79.50
Ariz...	285	280	48.0	134.40
U. S.	175.7	154.3	170.7	207.7	190.9	182.0	209.2	170.3	156.6	159.7	155.9	15.4	6.8	11.3	19.6	27.7	27.6	31.10	45.03

¹ Based upon farm price Dec. 1.

TABLE 122.—Cotton: Farm price, cents per pound, on 1st of each month, 1909-1918.

Date.	1918	1917	1916	1915	1914	1913	1912	1911	1910	1909	Average.
Jan. 1.....	28.9	17.1	11.4	6.6	11.7	12.2	8.4	14.4	14.6	8.4	13.4
Feb. 1.....	29.7	16.8	11.5	7.4	11.9	11.9	9.0	14.3	14.0	9.0	13.6
Mar. 1.....	30.2	15.9	11.1	7.4	12.6	11.8	9.8	13.9	14.0	9.0	13.6
Apr. 1.....	31.8	18.0	11.5	8.1	11.9	11.8	10.1	13.9	14.1	9.1	14.0
May 1.....	28.5	18.9	11.5	9.1	12.2	11.6	10.9	14.2	14.0	9.6	14.0
June 1.....	27.4	20.2	12.2	8.6	12.4	11.5	11.0	14.6	14.2	10.1	14.2
July 1.....	28.6	24.7	12.5	8.6	12.4	11.6	11.2	14.4	13.9	10.3	14.8
Aug. 1.....	27.8	24.3	12.6	8.1	12.4	11.5	12.0	13.2	14.3	11.3	14.8
Sept. 1.....	32.2	23.4	14.6	8.5	8.7	11.8	11.3	11.8	14.4	11.7	14.8
Oct. 1.....	31.8	23.3	15.5	11.2	7.8	13.3	11.2	10.2	13.3	12.6	15.0
Nov. 1.....	29.3	27.3	18.0	11.6	6.3	13.0	10.9	8.9	14.0	13.7	15.3
Dec. 1.....	27.6	27.7	19.6	11.3	6.8	12.2	11.9	8.8	14.1	13.9	15.4
Average.....	29.4	22.7	15.1	9.7	9.1	12.4	10.5	11.4	14.0	11.6	14.6

COTTON—Continued.

TABLE 123.—Cotton: Closing price of middling upland per pound, 1913-1918.

Date.	New York.			New Orleans.			Memphis.			Galveston.			Savannah.			Charleston.		
	Low.	High.	Average.	Low.	High.	Average.	Low.	High.	Average.	Low.	High.	Average.	Low.	High.	Average.	Low.	High.	Average.
1913.	<i>Cts.</i>	<i>Cts.</i>	<i>Cts.</i>	<i>Cts.</i>	<i>Cts.</i>	<i>Cts.</i>	<i>Cts.</i>	<i>Cts.</i>	<i>Cts.</i>	<i>Cts.</i>	<i>Cts.</i>	<i>Cts.</i>	<i>Cts.</i>	<i>Cts.</i>	<i>Cts.</i>	<i>Cts.</i>	<i>Cts.</i>	<i>Cts.</i>
Jan.-June.....	11.70	13.40	12.50	12½	13	12.46	12	13½	12.45	12	13	12.30	11½	12½	12.30	11½	12½	12.11
July-Dec.....	11.90	14.50	13.11	11½	14	12.92	11½	13½	12.93	11½	14½	13.01	11½	14½	12.71	12½	13½	13.18
1914.																		
Jan.-June.....	12.30	14.50	13.16	12½	13½	13.17	13	13½	13.32	12½	14	13.12	12½	13½	13.13	12½	13½	12.92
July-Dec.....	7.25	13.25	9.46	6½	13½	8.67	6½	13½	8.63	6½	13½	8.78	6½	13½	8.59	6½	8½	7.25
1915.																		
Jan.-June.....	7.90	10.60	9.27	7½	9.68	8.64	7½	9.50	8.55	7½	10.10	8.92	7½	9½	8.69	7½	9½	8.46
July-Dec.....	8.90	12.75	11.01	8.50	12.13	10.69	8.62	12.25	10.60	8.50	12.60	10.74	8½	12½	10.54	9	12	10.85
1916.																		
Jan.-June.....	11.20	13.45	12.31	11.13	13.06	12.08	11.38	13.25	12.30	11.45	13.75	12.52	11½	13	12.19	11	12½	11.94
July-Dec.....	12.90	20.95	16.61	13.00	20.38	16.27	13.12	20.50	16.59	13.65	20.85	16.64	13	20½	16.54	12½	20½	16.42
1917.																		
January.....	16.75	18.80	17.59	16.81	18.13	17.33	17.00	18.50	17.86	17.10	18.50	17.76	18½	18½	18.46	17½	18½	18.05
February.....	14.30	17.05	15.88	16.63	17.19	17.14	17.00	17.00	17.00	14.50	17.80	16.30	18½	18½	18.50	18½	18½	18.50
March.....	17.00	19.30	18.46	16.50	18.75	17.94	17.00	19.00	18.17	16.90	19.00	18.37	18½	19½	18.79	17½	19	18.58
April.....	19.35	21.15	20.33	18.75	20.25	19.51	19.00	20.50	19.97	19.00	20.25	19.66	19½	20½	20.14	19	20½	19.97
May.....	19.60	22.10	20.70	19.37	21.19	20.06	19.50	21.25	20.30	19.25	21.50	20.18	20½	21½	20.59	19½	21	20.54
June.....	22.65	27.40	25.33	21.44	26.25	24.18	21.50	26.00	24.00	22.00	26.50	24.58	21½	26½	24.84	21½	26	24.60
Jan.-June.....	14.30	27.40	19.72	16.50	26.25	19.36	17.00	26.00	19.55	14.50	26.50	19.48	18½	26½	20.22	17½	26	20.04
July.....	24.60	27.65	26.30	24.25	26.00	25.41	25.50	26.00	25.75	25.10	26.55	25.99	25	26½	25.95	24	26	25.80
August.....	23.10	28.00	25.53	22.50	26.50	25.07	25.00	26.50	26.00	22.75	27.50	25.68	22.63	27	25.14	22	25½	23.72
September.....	21.20	26.30	23.01	20.13	24.13	21.68	22.00	24.50	23.03	21.20	25.10	22.62	20	24½	21.87	20	24	21.22
October.....	25.25	29.95	28.02	24.13	27.75	26.76	24.00	28.50	27.50	24.40	27.75	26.82	24½	28	27.06	23½	27½	26.60
November.....	28.75	31.25	29.75	27.13	29.13	28.07	28.50	29.75	28.91	27.15	29.50	28.08	27½	29.13	28.26	27½	29	28.03
December.....	29.85	31.85	30.74	28.19	30.13	29.07	29.50	30.00	29.57	28.25	30.35	29.11	28.88	30	29.28	29	30½	29.16
July-Dec.....	21.20	31.85	27.22	20.13	30.13	26.01	22.00	30.00	26.79	21.20	30.35	26.38	20	30	26.26	20	30½	25.76

1918.

January.....	31.50	33.30	32.26	30.38	32.00	31.06	30.00	31.25	31.04	30.75	31.75	31.28	30.38	31.25	31.09	30.00	31.00	32.14
February.....	31.20	32.65	31.75	30.50	31.88	30.90	31.25	32.00	31.36	30.60	32.00	31.14	30.50	31.50	30.94	30.00	31.00	30.33
March.....	32.70	35.05	33.74	32.00	33.50	32.76	32.00	33.50	32.68	32.15	33.70	33.10	31.50	33.50	32.53	31.00	33.00	32.14
April.....	26.75	36.00	31.85	28.50	34.50	32.95	32.00	34.50	33.67	27.50	34.75	32.11	32.50	34.50	33.42	32.50	34.00	33.24
May.....	25.70	30.10	27.57	28.50	30.00	28.92	29.00	32.00	30.08	27.25	30.25	28.40	29.00	32.50	31.51	30.00	32.50	31.80
June.....	29.00	32.30	30.39	30.00	31.25	30.71	30.00	30.00	30.00	29.50	32.05	31.01	29.25	31.25	30.24	28.50	30.50	29.83
Jan.-June.....	25.70	36.00	31.26	28.50	34.50	31.22	29.00	34.50	31.47	27.25	34.75	31.18	29.00	34.50	31.62	28.50	34.00	31.58
July.....	28.55	34.10	31.54	27.75	31.00	29.50	30.00	30.00	30.00	26.75	32.05	29.38	28.25	31.25	30.08	29.00	30.00	29.92
August.....	29.70	37.30	34.65	27.75	33.25	30.23	30.00	33.50	30.98	26.75	35.50	31.60	28.25	34.50	31.22	30.00	32.50	30.23
September.....	32.65	38.20	35.09	32.25	34.50	33.22	32.50	35.00	34.33	31.50	36.35	34.99	31.25	35.25	32.91	32.00	35.00	33.00
October.....	30.20	34.55	32.44	29.50	33.13	31.18	30.00	33.50	31.56	30.00	34.25	32.25	29.25	32.75	30.55	29.50	32.50	30.60
November.....	27.75	31.60	29.69	28.75	30.38	29.76	29.50	30.50	30.17	29.25	31.50	30.37	29.00	30.00	29.43	27 $\frac{1}{2}$	29 $\frac{1}{2}$	28.75
December.....	27.50	33.00	30.25	28.50	31.25	29.69	29.00	30.50	29.44	29.40	32.50	30.68	29.00	31.00	29.54	27	30 $\frac{1}{2}$	29.33
July-Dec.....	27.50	38.20	32.28	27.80	34.50	30.60	29.00	35.00	31.08	26.75	36.35	31.55	28.25	35.25	30.62	27.00	35.00	30.30

COTTON—Continued.

TABLE 124.—Cotton: International trade, calendar years 1909–1917.

[Expressed in bales of 500 pounds gross weight, or 478 pounds net. The figures for cotton refer to ginned and unginced cotton and linters, but not to mill waste, cotton batting, *scarto* (Egypt and Sudan). Wherever unginced cotton has been separately stated in the original reports it has been reduced to ginned cotton in this statement at the ratio of 3 pounds unginced to 1 pound ginned. See "General note," table 93.]

EXPORTS.

[000 omitted.]

Country.	Average 1909– 1913.	1916 (pre- lim.)	1917 (pre- lim.)	Country.	Average 1909– 1913.	1916 (pre- lim.)	1917 (pre- lim.)
<i>From—</i>	<i>Bales.</i>	<i>Bales.</i>	<i>Bales.</i>	<i>From—</i>	<i>Balcs.</i>	<i>Balcs.</i>	<i>Balcs.</i>
Belgium.....	159	Netherlands.....	145	2
Brazil.....	83	5	27	Persia ¹	118	112
British India.....	1,966	Peru.....	87
China.....	240	237	235	United States.....	9,008	7,003	5,180
Egypt.....	1,442	1,122	855	Other countries.....	169
France.....	316	116	Total.....	13,965
Germany.....	232				

IMPORTS.

<i>Into—</i>				<i>Into—</i>			
Austria-Hungary.....	906	Russia.....	886	57
Belgium.....	496	Spain.....	382	471	447
Canada.....	137	205	178	Sweden.....	93
France.....	1,435	1,192	Switzerland.....	113	123
Germany.....	2,258	United Kingdom.....	4,164	4,045
Italy.....	896	1,170	828	United States.....	215	402	230
Japan.....	1,405	2,299	Other countries.....	319
Mexico.....	23	Total.....	14,005
Netherlands.....	277	177				

¹ Year beginning Mar. 21.

COTTONSEED.

TABLE 125.—Cottonseed: Farm price per ton on 15th of each month, 1910–1918.

Date.	1918	1917	1916	1915	1914	1913	1912	1911	1910
Jan. 15.....	\$67.51	\$52.53	\$36.85	\$19.14	\$22.70	\$21.98	\$16.57	\$26.35
Feb. 15.....	66.95	51.43	36.75	23.33	23.37	22.01	16.81	25.61
Mar. 15.....	68.27	53.18	36.56	22.32	23.60	21.55	18.21	25.49
Apr. 15.....	68.08	55.94	38.13	22.69	24.17	21.89	18.62	26.12
May 15.....	68.16	55.61	37.91	22.07	23.56	21.88	19.21	25.46
June 15.....	66.03	57.19	35.79	20.82	23.62	21.54	19.24	23.38
July 15.....	64.11	56.90	36.06	20.05	22.78	21.37	19.04	22.70
Aug. 15.....	61.34	56.61	35.22	20.14	20.16	20.24	18.02	20.45
Sept. 15.....	67.90	57.58	41.13	20.98	13.88	21.07	17.61	18.09	\$26.23
Oct. 15.....	65.85	65.02	47.19	33.73	15.28	22.01	18.04	16.73	26.86
Nov. 15.....	64.97	69.38	55.82	34.01	14.01	22.46	18.67	16.69	25.36
Dec. 15.....	65.05	68.29	56.35	35.54	17.73	23.48	21.42	16.70	25.65

COTTONSEED OIL.

TABLE 126.—Cottonseed oil: International trade, calendar years 1909-1917.

[See "General note," Table 93.]

EXPORTS.

[000 omitted.]

Country.	Average 1909-1913.	1916 (prelim.)	1917 (prelim.)	Country.	Average 1909-1913.	1916 (prelim.)	1917 (prelim.)
From—	Gallons.	Gallons.	Gallons.	From—	Gallons.	Gallons.	Gallons.
Belgium.....	1,086			United Kingdom.....	7,189	770	
China.....	281	1,972	1,388	United States.....	38,968	25,095	16,642
Egypt.....	476	418	648	Other countries.....	44		
France.....	335	40		Total.....	48,431		
Netherlands.....	52	26					

IMPORTS.

Into—			Into—			
Algeria.....	364		Mexico.....	3,607		
Australia.....	142	151	Netherlands.....	5,352	8,071	
Austria-Hungary.....	39		Norway.....	1,504	3,157	3,635
Belgium.....	2,251		Roumania.....	633		
Brazil.....	624	181	Senegal.....	422		
Canada.....	2,817	4,745	Serbia.....	336		
Egypt.....	257		Sweden.....	696		
France.....	3,289	2,015	United Kingdom.....	5,899	2,935	
Germany.....	6,918		Other countries.....	4,191		
Italy.....	4,600	145	71	Total.....	44,498	
Malta ¹	265					
Martinique.....	292					

¹ Year beginning Apr. 1.

TOBACCO.

TABLE 127.—Tobacco: Area and production of undermentioned countries, 1915-1917.

Country.	Area.			Production.		
	1915	1916	1917	1915	1916	1917
NORTH AMERICA.						
United States.....	<i>Acres.</i> 1,369,900	<i>Acres.</i> 1,413,400	<i>Acres.</i> 1,518,000	<i>Pounds.</i> 1,062,237,000	<i>Pounds.</i> 1,153,273,000	<i>Pounds.</i> 1,249,608,000
Porto Rico.....	16,308	13,212	(¹)	² 8,084,914	² 9,408,723	² 17,114,146
Canada:						
Quebec.....	4,500	2,933	5,000	4,050,000	3,000,000	5,000,000
Ontario.....	4,500	2,958	2,930	4,950,000	2,943,000	3,495,000
Total.....	9,000	5,891	7,930	9,000,000	5,943,000	8,495,000
Costa Rica.....	³ 2,734	2,701			900,000	
Cuba.....	(¹)					
Dominican Republic.....	(¹)			8,050,000	17,250,000	28,750,000
Guatemala.....	⁴ 1,236			⁴ 258,671	862,103	(¹)
Jamaica.....	⁴ 1,144					
Mexico.....	(¹)			⁵ 34,711,000		
SOUTH AMERICA.						
Argentina.....	37,955	18,187		(¹)	(¹)	(¹)
Brazil.....	(¹)	(¹)	(¹)	⁶ 59,734,874	⁶ 47,636,146	⁶ 56,788,527
Chile.....	1,033			3,260,824		
Uruguay.....	1,181	1,181	941		883,824	558,425
Paraguay.....					20,000,000	

¹ No official statistics.

² Exports, fiscal year beginning July 1.

³ Data for 1914.

⁴ Data for 1913.

⁵ Data for 1906.

⁶ Exports.

TOBACCO—Continued.

TABLE 127.—Tobacco: Area and production of undermentioned countries, 1915-1917—Continued.

Country.	Area.			Production.		
	1915	1916	1917	1915	1916	1917
EUROPE.						
Austria-Hungary:	<i>Acres.</i>	<i>Acres.</i>	<i>Acres.</i>	<i>Pounds.</i>	<i>Pounds.</i>	<i>Pounds.</i>
Austria.....	1 8,263			1 13,692,771		
Hungary.....	117,429			105,489,669		
Croatia-Slavonia.....	1 190			1 106,703		
Bosnia-Herzegovina.....	(?)			1 13,227,000		
Total.....				132,516,143		
Belgium.....	² 10,309			² 19,702,290		
Bulgaria.....	¹ 17,297			³ 33,069,000		
Denmark.....	524					
France.....	19,560	17,529	13,578	33,990,082	20,217,505	17,142,308
Germany.....	22,313	31,396		50,191,866		
Italy.....	19,768	17,297	16,309		19,841,400	
Netherlands.....	860	877	833	(?)	(?)	
Roumania.....	32,232	23,880		18,566,921		
Russia:						
Russia proper.....	96,161			163,982,988		
Poland.....	(?)			(?)		
Northern Caucasia.....	45,564			48,922,335		
Sweden.....				1,935,689	1,626,995	
Switzerland.....	618	494	551	947,978	837,748	881,840
ASIA.						
British India.....	1,105,330					
British North Borneo.....				1 3,621,754		
Ceylon.....	14,484			⁴ 3,118,321	⁴ 2,752,000	
Dutch East Indies:						
Java and Madura.....	² 394,636			² 108,979,540		
Sumatra, East Coast of.....	(?)			² 46,632,068		
Japanese Empire:						
Japan.....	75,423	70,747	65,185	108,415,099	105,642,000	91,766,475
Korea.....	33,244			30,382,000		
Formosa.....	1,769	2,656		2,073,244	3,737,000	
Philippine Islands.....	131,808	145,574	152,648	84,442,714	90,695,000	107,868,060
Russia, Asiatic.....	41,059			30,996,375		
AFRICA.						
Algeria.....	⁵ 22,733	(?)	25,254	⁵ 21,556,138	(?)	36,155,000
Tunis.....	314			³ 376,325		
Nyasaland.....	9,042			3,706,000		
Rhodesia.....	¹ 5,000			¹ 3,000,000		
Union of South Africa.....	⁶ 19,365	(?)	9,884	⁶ 14,961,199	(?)	6,999,825
OCEANIA.						
Australia.....	2,373	1,906	1,342	1,890,672	1,302,112	
Fiji.....	¹ 144			¹ 81,312		

¹ Data for 1913.² No official statistics.³ Data for 1914.⁴ Exports.⁵ Data for 1912.⁶ Census of 1911.

TABLE 128.—Tobacco: Total production of countries for which estimates were available, 1900-1915.

Year.	Production.	Year.	Production.	Year.	Production.	Year.	Production.
	<i>Pounds.</i>		<i>Pounds.</i>		<i>Pounds.</i>		<i>Pounds.</i>
1900.....	2,291,193,000	1904.....	2,146,641,000	1908.....	2,382,601,000	1912.....	1,274,319,097
1901.....	2,270,213,000	1905.....	2,279,728,000	1909.....	2,742,500,000	1913.....	2,149,258,036
1902.....	2,376,054,000	1906.....	2,270,298,000	1910.....	2,833,729,000	1914.....	2,254,086,747
1903.....	2,401,268,000	1907.....	2,391,061,000	1911.....	2,566,202,000	1915.....	2,153,395,336

TOBACCO—Continued.

TABLE 129.—Tobacco: Acreage, production, value, condition, etc., in the United States, 1849-1918.

NOTE.—Figures in *italics* are census returns; figures in roman are estimates of the Department of Agriculture. Estimates of acres are obtained by applying estimated percentages of increase or decrease to the published numbers of the preceding year, except that a revised base is used for applying percentage estimates whenever new census data are available.

Year.	Acreage (000 omitted).	Average yield per acre.	Production (000 omitted).	Average farm price per pound Dec. 1.	Farm value Dec. 1 (000 omitted).	Domestic exports of unmanufactured, fiscal year beginning July 1.	Imports of unmanufactured, fiscal year beginning July 1.	Condition of growing crop.			
								July 1.	Aug. 1.	Sept. 1.	When harvested.
	<i>Acres.</i>	<i>Lbs.</i>	<i>Lbs.</i>	<i>Cts.</i>	<i>Dolls.</i>	<i>Pounds.</i>	<i>Pounds.</i>	<i>P. ct.</i>	<i>P. ct.</i>	<i>P. ct.</i>	<i>P. ct.</i>
1849			199,753								
1859			434,209								
1869			262,735								
1879	639	739.7	472,661								
1889	695	702.5	488,257								
1899	1,101	788.5	868,113	7.2	62,104						
1900	1,046	778.0	814,345	6.6	53,661	315,787,782	26,851,253	88.5	82.9	77.5	70.1
1901	1,039	788.0	818,953	7.1	58,283	301,007,365	29,428,837	86.5	72.1	78.2	81.5
1902	1,031	797.3	821,824	7.0	57,564	368,184,084	34,016,956	85.6	81.2	81.5	84.1
1903	1,038	786.3	815,972	6.8	55,515	311,971,831	31,162,636	85.1	82.9	83.4	82.3
1904	1,006	819.0	660,461	8.1	53,383	334,302,091	33,288,378	85.3	83.9	83.7	85.6
1905	776	815.6	633,034	8.5	53,519	312,227,202	41,125,970	87.4	84.1	85.1	85.8
1906	796	857.2	682,429	10.0	68,233	340,742,864	40,898,807	86.7	87.2	86.2	84.6
1907	821	850.5	698,126	10.2	71,411	330,812,658	35,005,131	81.3	82.8	82.5	84.8
1908	875	820.2	718,061	10.3	74,130	287,900,946	43,123,196	86.6	85.8	84.3	84.1
1909	1,180	804.3	949,357								
1909	1,295	815.3	1,055,765	10.1	106,599	357,196,074	46,853,389	89.8	83.4	80.2	81.3
1910 ¹	1,366	807.7	1,103,415	9.3	102,142	355,327,072	48,203,288	85.3	78.5	77.7	80.2
1911	1,013	893.7	905,109	9.4	85,210	379,845,320	54,740,380	72.6	68.0	71.1	80.5
1912	1,226	785.5	962,855	10.8	104,063	418,796,906	67,977,118	87.7	82.8	81.1	81.8
1913	1,216	784.3	953,734	12.8	122,481	449,749,982	61,174,751	82.8	78.3	74.5	76.6
1914	1,224	845.7	1,034,679	9.8	101,411	348,346,091	45,764,728	66.0	66.5	71.4	81.8
1915	1,370	775.4	1,062,237	9.1	96,281	443,293,156	48,013,335	85.5	79.7	80.7	81.9
1916	1,413	816.0	1,153,278	14.7	169,672	411,598,860	46,136,347	87.6	84.4	85.5	85.6
1917	1,518	823.1	1,249,276	24.0	300,449	289,170,793	79,367,563	86.8	88.1	84.5	87.8
1918	1,549	865.1	1,340,019	27.9	374,318			83.1	83.6	82.4	87.4

¹ Figures adjusted to census basis.

TABLE 130.—Tobacco: Acreage, production, and total farm value, by States, 1918.

State.	Acreage.	Production.	Farm value Dec. 1.	State.	Acreage.	Production.	Farm value Dec. 1.
	<i>Acres.</i>	<i>Pounds.</i>	<i>Dollars.</i>		<i>Acres.</i>	<i>Pounds.</i>	<i>Dollars.</i>
Mass.....	10,000	15,000,000	6,000,000	Ohio.....	115,600	113,288,000	30,588,000
Connecticut.....	25,000	37,500,000	16,500,000	Indiana.....	16,300	15,159,000	3,032,000
New York.....	3,000	3,750,000	1,125,000	Illinois.....	700	532,000	90,000
Pennsylvania.....	45,600	64,752,000	16,188,000	Wisconsin.....	49,000	65,170,000	19,551,000
Maryland.....	28,600	23,738,000	7,121,000	Missouri.....	3,300	2,970,000	742,000
Virginia.....	190,000	146,300,000	38,038,000	Kentucky.....	475,000	427,500,000	98,325,000
West Virginia.....	13,600	9,792,000	2,546,000	Tennessee.....	77,800	62,240,000	10,581,000
N. Carolina.....	400,000	282,000,000	101,520,000	Alabama.....	1,000	700,000	210,000
S. Carolina.....	86,400	62,208,000	18,662,000	Louisiana.....	300	126,000	82,000
Georgia.....	2,900	2,668,000	1,334,000	Arkansas.....	300	210,000	52,000
Florida.....	4,600	4,416,000	2,031,000	U. S.....	1,549,000	1,340,019,000	374,318,000

TOBACCO—Continued.

TABLE 131.—Tobacco: Yield per acre, price per pound Dec. 1, and value per acre, by States.

State.	Yield per acre (pounds).											Farm price per pound (cents).						Value per acre (dollars). ¹	
	10-year average 1909-1918.	1909	1910	1911	1912	1913	1914	1915	1916	1917	1918	10-year average 1909-1918.	1914	1915	1916	1917	1918	5-year average 1914-1918.	1918
New Hampshire.....	1,700	1,720	1,700	1,700	1,650	1,770	1,400	1,650	18.0	12.0	17.0
Vermont.....	1,675	1,600	1,700	1,700	1,550	1,700	1,300	1,600	18.0	11.0	19.0
Massachusetts.....	1,564	1,600	1,730	1,650	1,700	1,550	1,750	1,100	1,660	1,400	1,500	23.0	17.7	14.5	25.0	38.4	40.0	404.37	600.00
Connecticut.....	1,590	1,650	1,730	1,625	1,700	1,550	1,770	1,350	1,630	1,400	1,500	24.4	18.5	17.0	27.0	38.4	44.0	438.93	660.00
New York.....	1,230	1,175	1,250	1,330	1,300	1,020	1,300	1,200	1,230	1,200	1,250	13.8	12.0	9.5	13.0	22.0	30.0	215.98	375.00
Pennsylvania.....	1,354	985	1,500	1,420	1,450	1,200	1,450	1,350	1,360	1,400	1,420	12.2	8.5	9.2	14.2	21.0	25.0	217.91	355.00
Maryland.....	746	710	690	735	660	740	800	740	770	790	830	12.3	8.0	8.5	16.0	20.0	30.0	131.42	249.00
Virginia.....	728	775	780	800	600	770	650	750	680	700	770	13.8	9.0	9.4	14.6	26.5	26.0	124.12	200.20
West Virginia.....	782	875	640	750	760	680	820	870	900	800	720	14.2	11.0	10.0	15.0	26.0	26.0	147.88	187.20
North Carolina.....	636	600	600	710	620	670	650	620	550	630	705	17.6	11.5	11.2	20.0	31.5	36.0	141.29	283.80
South Carolina.....	696	800	630	810	700	760	730	580	520	710	720	13.7	9.7	7.0	14.0	23.1	30.0	112.84	216.00
Georgia.....	909	700	680	900	830	1,000	1,000	880	1,180	1,000	920	32.5	25.0	23.0	27.0	57.0	50.0	360.08	460.00
Florida.....	935	710	680	940	840	1,000	1,000	910	1,210	1,100	960	33.2	30.0	23.0	30.0	57.0	46.0	388.18	441.60
Ohio.....	902	925	810	925	920	750	900	900	950	960	980	13.0	8.8	9.0	13.0	25.0	27.0	157.66	264.60
Indiana.....	884	950	880	910	800	750	900	840	930	950	930	11.8	9.0	7.3	13.0	20.0	20.0	135.44	186.00
Illinois.....	769	750	790	750	760	700	780	850	750	800	760	11.6	12.0	9.0	10.0	19.0	17.0	105.26	129.20
Wisconsin.....	1,163	1,180	1,050	1,250	1,290	1,180	1,180	900	1,270	1,000	1,330	12.7	11.0	6.0	12.5	17.5	30.0	181.56	399.00
Missouri.....	928	885	1,050	800	1,000	650	1,200	900	950	940	900	14.8	13.0	12.0	15.0	21.2	25.0	166.16	225.00
Kentucky.....	848	835	810	880	780	760	910	810	900	900	900	11.8	8.4	7.8	12.7	20.0	23.0	133.04	207.00
Tennessee.....	766	730	760	810	660	720	820	750	800	810	800	9.8	7.5	6.3	10.1	17.0	17.0	92.31	136.00
Alabama.....	618	600	500	700	750	700	700	500	300	730	700	27.9	28.0	22.0	30.0	35.0	30.0	172.30	210.00
Louisiana.....	434	550	550	450	300	450	400	420	450	350	420	34.1	35.0	30.0	28.0	35.0	65.0	157.50	273.00
Texas.....	650	600	650	700	600	580	500	700	21.0	27.0	20.0	52.0
Arkansas.....	626	600	650	600	650	650	610	600	500	700	700	18.1	18.0	17.0	20.0	23.2	25.0	129.84	175.00
United States.....	820.1	804.3	807.7	893.7	785.5	784.3	845.7	775.4	816.0	823.1	865.1	13.8	9.8	9.1	14.7	24.0	27.9	142.57	241.65

¹ Based upon farm price Dec. 1.

TOBACCO—Continued.

TABLE 132.—Tobacco: Acreage, production, and farm value, by types and districts, 1917 and 1918.

Type and district.	Acreage (thousands of acres).		Yield per acre (pounds).		Production (thousands of pounds).		Average farm price per pound Dec. 1 (cents).		Total farm value (thou- sands of dollars). ¹	
	1918	1917	1918	1917	1918	1917	1918	1917	1918	1917
I. CIGAR TYPES.										
New England.....	35.0	33.0	1,500	1,400	52,500	46,200	38.4	17,740
New York.....	3.0	2.5	1,250	1,250	3,760	3,125	22.0	688
Pennsylvania.....	45.6	41.5	1,420	1,400	64,752	58,100	21.0	12,201
Ohio-Miami Valley.....	68.7	63.6	980	970	67,326	61,692	24.0	14,806
Wisconsin.....	49.0	44.5	1,330	1,000	65,170	44,500	17.5	7,788
Georgia and Florida.....	7.5	4.7	945	1,066	7,084	5,010	37.0	2,856
Total cigar types...	208.8	189.8	1,248	1,152	260,592	218,627	25.7	56,079
II. CHEWING, SMOKING, SNUFF, AND EXPORT TYPES.										
Burley.....	280.3	262.0	960	960	269,088	251,520	No price given, as but few sales have been made in most districts.	26.5	No value given, as but few sales have been made in most districts.	66,653
Paducah.....	95.0	118.0	800	800	76,000	94,400		14.0		13,216
Henderson or stemming..	91.4	101.6	930	890	85,062	90,424		15.5		14,016
One-sucker.....	50.0	50.0	900	900	45,000	45,000		17.0		7,650
Clarksville and Hopkins- ville.....	100.0	120.0	770	800	77,000	96,000		14.8		14,208
Virginia sun-cured.....	13.2	11.0	850	800	11,220	8,800		28.5		2,508
Virginia dark.....	68.2	62.0	860	830	57,052	51,460		17.0		8,778
Old belt, Virginia and North Carolina.....	242.0	225.0	710	600	171,820	141,000		32.0		45,120
New belt, North Carolina and South Carolina.....	350.0	325.0	710	670	248,500	217,750		29.6		64,454
Maryland and eastern Ohio export.....	34.6	32.0	830	810	28,718	25,920		20.0		5,184
Perique—Louisiana.....	.3	.6	420	350	126	210	35.0	74		
Total chewing, smoking, snuff, and export types.	1,325.0	1,317.2	807	780	1,069,526	1,022,484	23.6	241,831
All other.....	15.2	10.8	652	775	9,901	8,165	30.1	2,539
Total.....	1,549.0	1,517.8	865	823	1,340,019	1,249,276	24.0	300,449

¹ Based upon farm price Dec. 1.

TOBACCO—Continued.

TABLE 133.—Tobacco: Wholesale price per pound, 1913-1918.

Date.	Cincinnati, leaf, plug stock, common to good red. ¹			Hopkinsville, leaf, common to fine.			Louisville, leaf (Burley, dark red), common to good.			Clarksville, leaf, common to fine. ²			Richmond, leaf, smokers, common to fine. ³			Baltimore, leaf (Maryland), medium to fine red.		
	Low.	High.	Average.	Low.	High.	Average.	Low.	High.	Average.	Low.	High.	Average.	Low.	High.	Average.	Low.	High.	Average.
1913.	<i>Cents.</i>	<i>Cents.</i>	<i>Cents.</i>	<i>Cents.</i>	<i>Cents.</i>	<i>Cents.</i>	<i>Cents.</i>	<i>Cents.</i>	<i>Cents.</i>	<i>Cents.</i>	<i>Cents.</i>	<i>Cents.</i>	<i>Cents.</i>	<i>Cents.</i>	<i>Cents.</i>	<i>Cents.</i>	<i>Cents.</i>	<i>Cents.</i>
Jan.-June.....	5.50	13.75	7.00	14.00	7.00	14.00	9.00	14.00	6.00	16.00	8.50	15.00
July-Dec.....	5.50	13.75	8.75	14.00	9.00	16.00	8.50	15.00	7.00	16.00	8.50	15.00
1914.																		
Jan.-June.....	5.50	14.00	8.00	14.00	9.00	16.00	9.50	16.00	7.00	20.00	8.50	15.00
July-Dec.....	5.50	13.00	7.50	14.00	9.00	16.00	7.50	16.00	7.00	20.00	8.00	15.00
1915.																		
Jan.-June.....	6.00	13.00	4.00	12.50	8.00	14.00	6.00	13.00	7.00	20.00	8.00	13.00
July-Dec.....	5.00	13.00	5.50	10.00	10.00	15.00	6.00	13.00	7.00	20.00	8.00	14.00
1916.																		
Jan.-June.....	5.00	16.00	5.00	14.00	10.00	16.00	4.50	13.00	7.00	20.00	9.00	16.00
July-Dec.....	7.50	17.00	7.50	14.50	11.00	19.00	4.50	12.00	9.00	18.00	11.00	21.00
1917.																		
January.....			10.75	17.00	13.00	19.00	9.00	18.00	17.00	21.00
February.....	16.00	21.00	11.00	19.00	15.00	20.00	14.10	14.10	9.00	18.00	17.00	21.00
March.....	16.00	21.00	10.50	16.00	15.00	20.00	8.00	14.00	9.00	18.00	17.00	21.00
April.....	15.00	21.00	10.00	16.00	15.00	20.00	9.00	18.00	18.00	24.00
May.....	15.00	20.00	10.00	14.50	15.00	20.00	8.00	14.00	12.00	27.00	18.00	24.00
June.....	15.00	20.00	10.50	14.00	15.00	20.00	8.00	14.50	12.00	27.00	19.00	24.00
Jan.-June.....	15.00	21.00	10.00	19.00	13.00	20.00	8.00	14.50	9.00	27.00	17.00	24.00
July.....	15.00	20.00	10.50	14.00	17.00	24.00	12.00	15.00	12.00	27.00	19.00	26.00
August.....	15.00	20.00	21.00	24.00	6.00	14.00	21.00	26.00
September.....	15.00	20.00	22.00	24.00	22.00	28.00
October.....	15.00	28.00	22.00	24.00	22.00	28.00
November.....	23.00	28.00	24.00	32.00	22.00	28.00
December.....	23.00	28.00	13.50	20.50	24.00	32.00	22.00	28.00
July-Dec.....	15.00	28.00	10.50	20.50	17.00	32.00	6.00	15.00	12.00	27.00	19.00	28.00

1918.																		
January	23.00	28.00	25.50				25.00	30.00	27.50				23.00	24.00	23.50	22.00	28.00	25.00
February	23.00	28.00	25.50	14.00	21.00	17.08	25.00	30.00	27.50				21.00	28.00	24.50	22.00	28.00	25.00
March	23.00	28.00	25.50	14.00	21.00	17.42	25.00	31.00	27.75				25.00	30.00	27.50	22.00	28.00	25.00
April	22.00	40.00	31.00	15.00	22.50	18.15	25.00	32.00	28.30				23.50	25.00	24.25	22.50	30.00	26.25
May	22.00	40.00	31.00	14.50	23.50	18.94	27.00	32.00	29.50				25.11	25.11	25.11	22.50	38.00	27.94
June	22.00	40.00	31.00	14.00	23.50	18.92	27.00	44.00	34.00				()	(⁵)	(⁵)	28.00	39.00	33.38
Jan.-June	22.00	40.00	28.25	14.00	23.50	18.10	25.00	44.00	29.09				21.00	30.00	24.97	22.00	39.00	27.10
July	22.00	40.00	31.00	14.50	25.00	19.50	33.00	44.00	38.50							34.00	49.00	40.50
August	22.00	40.00	31.00	16.00	25.00	20.42	36.00	44.00	40.00							36.50	49.00	42.75
September	22.00	40.00	31.00				36.00	44.00	40.00							36.50	49.00	42.75
October	22.00	40.00	31.00				36.00	44.00	40.00							33.00	49.00	41.19
November	22.00	40.00	31.00				36.00	44.00	40.00							33.00	40.00	36.50
December	22.00	40.00	31.00				30.00	44.00	39.00							33.00	40.00	36.50
July-Dec.	22.00	40.00	31.00	14.50	25.00	19.96	30.00	44.00	39.58							33.00	49.00	40.03

¹ Burley, dark and bright red, common to good, February to December, 1917, inclusive, and all of 1918.

² No quotations for 1918.

³ No quotations for July-December, 1918.

⁴ No grades given; quotations are average cents per pound for all grades.

⁵ Closed.

TOBACCO—Continued.

TABLE 134.—Tobacco (unmanufactured): International trade, calendar years 1909–1917.

[Tobacco comprises leaf, stems, strippings, and *tombac*, but not snuff. See "General note," Table 93.]

EXPORTS.

[000 omitted.]

Country.	Average, 1909– 1913.	1916 (pre- limi- nary).	1917 (pre- limi- nary).	Country.	Average, 1909– 1913.	1916 (pre- limi- nary).	1917 (pre- limi- nary).
<i>From—</i>	<i>Pounds.</i>	<i>Pounds.</i>	<i>Pounds.</i>	<i>From—</i>	<i>Pounds.</i>	<i>Pounds.</i>	<i>Pounds.</i>
Aden ¹	7,739	Mexico.....	1,845
Algeria.....	11,681	Netherlands.....	3,786	4,760
Austria-Hungary.....	23,192	Paraguay.....	11,361
Brazil.....	59,991	46,943	56,788	Persia ²	3,874
British India.....	28,874	Philippine Islands.....	26,018	39,655	15,134
Bulgaria.....	4,310	Russia.....	23,283	16,106
Ceylon.....	4,093	United States.....	381,127	483,955	254,702
Cuba.....	38,035	Other countries.....	94,995
Dominican Republic.....	22,395	Total.....	928,535
Dutch East Indies.....	163,823				
Greece.....	18,113				

IMPORTS.

<i>Into—</i>				<i>Into—</i>			
Aden ¹	11,619	Italy.....	47,732	40,833	55,019
Argentina.....	14,988	19,168	27,321	Netherlands.....	57,218	59,787
Australia.....	13,740	16,878	Norway.....	3,994	5,171	4,915
Austria-Hungary.....	49,984	Portugal.....	6,565
Belgium.....	22,094	Nigeria.....	6,050
British India.....	6,538	Spain.....	51,026	33,492	41,342
Canada.....	17,891	20,878	18,570	Sweden.....	9,772
China.....	15,113	19,618	20,525	Switzerland.....	17,949	21,826
Denmark.....	8,774	United Kingdom.....	117,956	151,196
Egypt.....	19,005	15,000	14,274	United States.....	52,768	49,473	57,960
Finland.....	9,597	14,947	Other countries.....	51,366
France.....	63,914	65,924	Total.....	844,090
Germany.....	168,437				

¹ Year beginning Apr. 1.² Year beginning Mar. 21.

APPLES.

TABLE 135.—Apples: Production and prices, Dec. 1, by States, 1917 and 1918.

State.	Apples.							
	Total crop (000 omitted).		Commercial crop (000 omitted).		Price Dec. 1.			
					Per bushel.		Per barrel.	
	1918	1917	1918	1917	1918	1917	1918	1917
Maine.....	<i>Bu.</i> 2,287	<i>Bu.</i> 4,617	<i>Bbbs.</i> 225	<i>Bbbs.</i> 400	<i>Dolls.</i> 0.95	<i>Dolls.</i> 0.95	<i>Dolls.</i> 2.80	<i>Dolls.</i> 2.75
New Hampshire.....	1,944	1,035	121	120	1.10	1.20	3.20	3.40
Vermont.....	1,002	1,286	114	135	1.40	1.30	4.10	4.00
Massachusetts.....	2,446	2,186	300	225	1.60	1.55	4.20	4.50
Rhode Island.....	201	198	12	11	1.55	1.50	4.60	3.75
Connecticut.....	1,184	1,316	120	100	1.55	1.44	3.90	4.00
New York.....	37,253	9,995	7,037	2,380	1.12	1.32	3.65	3.95
New Jersey.....	2,464	2,041	752	408	1.60	1.25	4.60	3.82
Pennsylvania.....	17,775	12,150	1,177	911	1.20	1.26	3.40	3.60
Delaware.....	500	450	184	186	1.25	1.10	4.50	3.40
Maryland.....	2,365	2,525	330	256	1.10	.97	3.00	2.75
Virginia.....	9,000	9,970	1,766	1,650	1.24	1.01	3.95	3.30
West Virginia.....	8,174	5,994	1,145	702	1.17	1.22	3.55	3.68
North Carolina.....	5,460	6,156	184	200	1.30	1.14	4.20	3.40
South Carolina.....	800	800	2.05	1.55	5.70	4.65
Georgia.....	1,760	1,754	117	120	1.65	1.20	5.25	3.50
Ohio.....	8,316	6,336	954	532	1.53	1.50	4.64	4.30
Indiana.....	2,070	5,508	230	434	1.80	1.21	5.30	3.67
Illinois.....	3,213	7,519	754	1,554	1.85	1.10	6.00	3.50
Michigan.....	10,966	4,020	1,124	515	1.15	1.40	3.75	4.25
Wisconsin.....	2,061	2,436	105	124	1.55	1.34	4.80	4.25
Minnesota.....	792	1,188	33	50	2.09	1.55	6.11	4.50
Iowa.....	1,620	5,445	79	250	2.06	1.45	6.40	4.45
Missouri.....	4,245	7,818	600	1,128	1.64	1.06	5.10	3.08
South Dakota.....	109	246	3	5	2.35	1.70	6.80	4.50
Nebraska.....	450	618	59	225	2.30	1.40	7.00	4.55
Kansas.....	2,139	5,176	333	650	1.90	1.35	5.65	3.87
Kentucky.....	3,780	7,140	84	143	1.70	1.17	5.00	3.60
Tennessee.....	4,700	5,000	150	150	1.56	1.22	4.50	3.75
Alabama.....	1,551	1,452	26	24	1.70	1.40	6.00	4.25
Mississippi.....	488	315	1.30	1.45	5.10	5.00
Texas.....	198	429	11	23	1.60	1.56	4.50	4.55
Oklahoma.....	453	1,350	17	54	2.01	1.30	6.00	3.70
Arkansas.....	1,314	2,193	241	402	1.40	1.35	4.20	3.95
Montana.....	790	911	75	74	2.10	1.00
Colorado.....	1,845	2,640	527	701	1.70	.80
New Mexico.....	683	870	117	175	1.18	1.50
Arizona.....	152	135	15	16	2.40	2.05
Utah.....	780	906	163	184	1.40	.80
Nevada.....	175	192	1.60	1.60
Idaho.....	582	3,882	112	906	1.70	.95	3.00
Washington.....	1,459	17,325	4,296	4,620	1.25	1.25
Oregon.....	3,500	3,723	671	713	1.10	1.05
California.....	5,577	5,871	1,127	1,174	1.30	1.15
United States.....	173,632	163,117	25,490	22,630	1.32	1.22

APPLES—Continued.

TABLE 136.—Apples: Production (bushels) in the United States, 1889–1918.

Year.	Production.	Year.	Production.	Year.	Production.
1889 ¹	143, 105, 000	1899 ¹	175, 397, 000	1909 ¹	146, 122, 000
1890.....	80, 142, 000	1900.....	205, 930, 000	1910.....	141, 640, 000
1891.....	198, 907, 000	1901.....	135, 500, 000	1911.....	214, 020, 000
1892.....	120, 536, 000	1902.....	212, 330, 000	1912.....	235, 220, 000
1893.....	114, 773, 000	1903.....	195, 680, 000	1913.....	145, 410, 000
1894.....	134, 648, 000	1904.....	233, 630, 000	1914.....	253, 200, 000
1895.....	219, 600, 000	1905.....	136, 220, 000	1915.....	230, 011, 000
1896.....	232, 600, 000	1906.....	216, 720, 000	1916.....	204, 582, 000
1897.....	163, 728, 000	1907.....	119, 560, 000	1917.....	163, 117, 000
1898.....	118, 061, 000	1908.....	148, 940, 000	1918.....	173, 632, 000

¹ Census figures.

TABLE 137.—Estimated annual production of the commercial apple crop in the United States for the years 1916 to 1918, inclusive.

[By commercial crop is meant that portion of the total crop which is sold for consumption as fresh fruit. One barrel is equivalent to three boxes.]

State.	1918	1917	1916
	<i>Barrels.</i>	<i>Barrels.</i>	<i>Barrels.</i>
Maine.....	225, 000	400, 000	425, 000
New Hampshire.....	121, 000	120, 000	162, 000
Vermont.....	114, 000	135, 000	346, 000
Massachusetts.....	300, 000	225, 000	300, 000
Rhode Island.....	12, 500	11, 000	13, 000
Connecticut.....	120, 000	100, 000	104, 000
New York.....	7, 037, 000	2, 380, 000	6, 930, 000
New Jersey.....	751, 500	408, 000	373, 000
Pennsylvania.....	1, 177, 000	911, 000	1, 397, 000
Delaware.....	184, 000	186, 000	69, 000
Maryland.....	330, 000	256, 000	217, 000
Virginia.....	1, 766, 000	1, 650, 000	1, 995, 000
West Virginia.....	1, 145, 000	702, 000	1, 271, 000
North Carolina.....	184, 000	200, 000	218, 000
Georgia.....	117, 000	120, 000	97, 000
Ohio.....	954, 000	532, 000	721, 000
Indiana.....	230, 000	434, 000	262, 000
Illinois.....	754, 000	1, 554, 000	566, 000
Michigan.....	1, 124, 000	515, 000	1, 414, 000
Wisconsin.....	105, 000	124, 000	105, 000
Minnesota.....	33, 000	50, 000	42, 000
Iowa.....	79, 000	250, 000	110, 000
Missouri.....	600, 000	1, 128, 000	675, 000
South Dakota.....	3, 000	5, 000	5, 000
Nebraska.....	59, 000	225, 000	142, 000
Kansas.....	333, 000	650, 000	560, 000
Kentucky.....	84, 000	143, 000	157, 000
Tennessee.....	150, 000	150, 000	147, 000
Alabama.....	26, 000	24, 000	19, 000
Texas.....	11, 000	23, 000	20, 000
Oklahoma.....	17, 000	54, 000	27, 000
Arkansas.....	241, 000	402, 000	245, 000
Montana.....	75, 000	74, 000	69, 000
Colorado.....	527, 000	701, 000	367, 000
New Mexico.....	117, 000	175, 000	59, 000
Arizona.....	15, 000	16, 000	17, 000
Utah.....	163, 000	184, 000	3, 000
Idaho.....	112, 000	906, 000	15, 000
Washington.....	4, 296, 000	4, 620, 000	3, 467, 000
Oregon.....	671, 000	713, 000	750, 000
California.....	1, 127, 000	1, 174, 000	1, 210, 000
United States.....	25, 490, 000	22, 630, 000	25, 091, 000

APPLES—Continued.

TABLE 138.—Estimated annual production by regions of the commercial apple crop in the United States, 1917 and 1918.

Region.	1917	1918	Region.	1917	1918
	<i>Barrels.¹</i>	<i>Barrels.¹</i>		<i>Barrels.¹</i>	<i>Barrels.¹</i>
Western New York.....	1,118,000	5,700,000	Southern and western Illinois.....	1,320,000	638,000
New England.....	750,000	645,000	Ozark.....	793,000	429,000
Hudson Valley.....	1,074,000	764,000	Arkansas River region.....	197,000	123,000
Shenandoah - Cumberland and Piedmont district.....	2,080,000	2,600,000	Missouri River region.....	1,239,000	592,000
South Ohio Rome Beauty district.....	578,000	465,000	Pacific Northwest.....	6,313,000	5,154,000
Western Michigan.....	121,000	317,000	Colorado.....	701,000	527,000
	350,000	826,000	California.....	1,174,000	1,127,000

¹ 1 barrel is equivalent to 3 boxes.

TABLE 139.—Apples: Farm price, cents per bushel, on 1st of each month, 1910-1918.

Date.	1918	1917	1916	1915	1914	1913	1912	1911	1910
Jan. 1.....	128.8	101.1	79.7	68.0	107.1	73.4	89.4	108.0
Feb. 1.....	140.1	110.0	88.0	71.2	116.8	76.4	95.8	117.2	108.8
Mar. 1.....	145.3	123.3	92.0	73.2	126.0	80.4	101.2	121.6	112.6
Apr. 1.....	151.3	133.0	94.9	76.8	133.0	83.7	109.2	131.8	114.2
May 1.....	154.8	149.8	98.0	85.4	141.8	89.5	121.8	139.2	120.7
June 1.....	158.2	157.2	105.4	90.4	141.0	97.6	118.4	137.5	119.6
July 1.....	150.4	151.1	108.1	84.4	113.4	93.6	95.2	115.1	94.4
Aug. 1.....	128.1	127.0	86.4	70.1	79.9	80.6	75.0	83.9	75.4
Sept. 1.....	123.7	107.8	77.7	59.9	65.1	75.8	64.8	71.6	73.7
Oct. 1.....	133.5	106.8	83.1	62.0	58.8	81.0	61.8	68.0	75.5
Nov. 1.....	138.6	117.5	87.6	69.2	56.6	90.0	62.4	69.4	83.4
Dec. 1.....	132.5	121.5	91.2	69.0	59.4	98.1	66.3	72.1	89.6

APPLES—Continued.

TABLE 140.—Approximate relative production of principal varieties of apples, expressed as percentages of a normal crop of all apples.

Variety.	United States.	Maine.	New York.	Pennsylvania.	Virginia.	West Virginia.	Ohio.	Michigan.	Illinois.	Missouri.	Kentucky.	Arkansas.	Washington.	Oregon.	California.
Arkansas (Mammoth Black Twig).....	P. ct. 0.7	P. ct. 0.2	P. ct. 0.3	P. ct. 3.1	P. ct. 0.7	P. ct. 0.6	P. ct. 0.0	P. ct. 0.9	P. ct. 1.1	P. ct. 0.9	P. ct. 2.3	P. ct. 0.3	P. ct. 0.3
Arkansas Black.....	0.9	0.2	0.7	0.2	1.1	0.7	1.5	3.0	3.0	2.3	1.1	1.0
Baldwin.....	13.4	34.5	31.3	17.8	2.2	5.2	15.1	17.0	2.8	1.5	2.9	4.4	7.8	12.6	3.2
Ben Davis.....	13.3	9.8	5.0	6.0	11.4	15.7	13.9	8.5	37.0	34.2	16.8	44.1	7.4	4.9	3.9
Early Harvest (Prince's Harvest).....	2.8	9.9	9.9	3.1	4.7	3.9	3.7	1.8	2.2	2.8	6.4	2.0	2.8	7.7	0.7
Fall Pippin.....	1.7	7.7	1.7	3.1	1.8	1.5	1.8	1.6	1.1	4.4	2.4	0.7	2.2	2.8	0.6
Fameuse (Snow).....	1.3	3.5	2.4	0.6	1.1	0.8	3.0	1.5	4.4	0.1	0.1	0.1	0.1	0.1	0.0
Gano.....	1.6	3.3	2.2	0.8	0.6	1.6	1.3	3.3	3.8	6.5	0.2	6.6	0.1	1.0	0.2
Golden Russet.....	1.4	1.7	2.0	2.5	0.3	1.6	0.9	3.7	0.7	0.3	1.0	0.1	0.1	0.3	0.6
Gravenstein.....	1.1	2.3	0.9	1.0	0.1	0.1	0.1	0.1	0.1	0.1	0.0	0.0	4.1	7.3	8.9
Grimes (Grimes Golden).....	2.2	0.2	0.1	2.6	2.6	4.6	5.0	1.2	4.9	3.6	2.6	2.1	1.6	4.4	0.1
Horse (Yellow Horse).....	0.9	1.0	0.0	0.0	0.0	0.2	0.2	0.5	2.1	1.5	0.1
Jonathan.....	3.6	8.8	4.4	1.4	1.0	1.7	1.8	2.2	9.3	10.4	2.5	3.7	13.8	4.4	1.7
Lambertwig (Red Lambertwig).....	1.6	0.0	0.0	2.5	0.8	0.3	0.0	0.6	1.5	4.0	5.8	0.2	0.3
McIntosh (McIntosh Red).....	0.9	3.7	1.6	0.7	0.1	0.1	0.1	0.3	0.4	0.1	0.1	0.1	0.3	0.1	0.1
Maiden Blush.....	2.0	0.3	1.0	3.0	1.5	2.5	4.5	2.6	2.3	2.8	4.5	1.0	0.3	0.2	0.4
Missouri (Missouri Pippin).....	0.8	0.0	0.0	0.0	0.2	0.1	0.1	1.2	3.0	3.0	0.5	1.4	0.5	0.1	0.9
Northern Spy.....	6.1	7.1	13.1	11.4	0.8	4.2	7.7	17.9	1.4	1.1	1.4	1.5	3.8	7.4	0.6
Northwestern Greening.....	0.9	0.3	0.9	0.4	0.0	0.4	0.6	1.9	0.3	0.3	0.4	1.0	0.1	0.2
Oldenburg (Duchess of Oldenburg).....	1.9	2.9	2.2	1.1	0.1	0.5	1.0	5.0	1.7	0.5	0.1	1.1	0.3	0.1
Red Astrachan.....	1.9	3.9	2.1	3.5	0.8	2.1	2.7	2.8	0.8	0.8	0.3	0.5	1.7	2.2	3.3
Red June (Carolina Red June).....	1.6	0.7	0.3	1.8	1.3	0.2	0.0	1.2	1.9	4.3	2.7	1.3	1.3	1.4
Rhode Island Greening.....	4.7	4.1	14.8	5.5	0.3	1.4	5.7	5.4	0.8	0.3	0.2	0.6	2.2	2.6	2.7
Rome Beauty.....	3.1	1.1	0.3	2.1	1.2	18.7	10.8	2.3	3.8	1.7	9.6	1.8	12.2	5.6	2.4
Stayman Winesap.....	1.5	0.6	0.1	1.8	5.3	1.9	1.3	0.1	0.5	1.8	1.9	1.7	2.7	1.8	0.9
Tolman (Tolman Sweet).....	1.0	2.6	2.1	1.1	0.1	0.4	0.5	2.4	0.3	0.2	0.3	0.9	0.0
Tompkins King (King of Tompkins Co.).....	1.4	2.4	4.1	1.5	0.0	0.5	0.6	2.1	0.1	0.1	0.0	2.7	5.1	1.1
Wealthy.....	2.2	5.4	1.8	1.2	0.0	1.1	1.2	3.7	1.6	1.3	0.4	0.1	1.5	1.1	0.1
White Pearmain (White Winter Pearmain).....	0.5	0.1	0.0	0.2	0.2	0.1	0.0	0.2	0.3	0.3	0.1	0.6	0.5	7.5
Winesap.....	5.1	0.5	0.1	1.8	20.7	1.8	1.8	0.4	5.6	6.8	14.0	8.4	7.1	2.9	1.4
Wolf River.....	0.9	1.4	0.3	0.3	0.2	0.6	0.5	1.5	0.4	0.7	0.3	0.8	1.7	0.1
Yellow Bellflower.....	1.4	1.7	0.3	2.3	0.2	1.5	1.3	1.2	0.5	1.0	0.6	0.1	1.9	3.4	18.6
Yellow Newtown (Albermarle; Newtown Pippin).....	1.6	0.0	0.2	0.6	7.0	0.3	0.4	0.3	0.2	0.1	0.2	2.9	11.3	28.7
Yellow Transparent.....	1.5	1.1	0.3	1.7	1.5	3.2	2.1	1.4	2.1	1.1	3.2	0.4	1.5	1.6	0.2
York Imperial (Johnston Fine Winter).....	2.1	0.1	7.5	15.1	5.0	1.3	0.3	0.8	1.1	0.1	0.1	0.2	0.9	0.1
Other varieties.....	10.4	7.0	8.9	12.8	10.2	13.4	10.1	11.0	7.4	8.2	12.5	8.2	12.5	15.5	8.2
Total.....	100.0	100.0	100.0	100.0	100.0	100.0	100.0	100.0	100.0	100.0	100.0	100.0	100.0	100.0	100.0

NOTE.—In important apple-producing States not included in table, the principal varieties and their respective percentages of all apples in a normal crop are:

Indiana.—Ben Davis 22.0, Baldwin 7.2, Grimes Golden 6.7, Winesap 6.7, Maiden Blush 5.8, Rome Beauty 4.4, Northern Spy 4.2. North Carolina.—Lambertwig 14.3, Winesap 12.2, Ben Davis 7.5, Early Harvest 7.2, Horse 7.2, Red June 5.9. Tennessee.—Winesap 14.1, Ben Davis 12.2, Lambertwig 12.1, Early Harvest 8.4, Horse 6.3, Red June 5.4. Iowa.—Ben Davis 15.2, Wealthy 12.4, Jonathan 10.3, Oldenburg 8.9, Grimes Golden 4.9, Northwestern Greening 4.3. Kansas.—Ben Davis 19.4, Winesap 10.3, Jonathan 13.8, Missouri Pippin 8.6, Gano 6.0, Maiden Blush 4.3. Colorado.—Ben Davis 26.3, Jonathan 18.3, Gano 7.8, Rome Beauty 4.8, Winesap 4.1. Massachusetts.—Baldwin 48.4, Rhode Island Greening 9.3, Gravenstein 5.7, McIntosh 5.7, Northern Spy 5.1. Nebraska.—Ben Davis 21.3, Winesap 13.6, Jonathan 9.4, Wealthy 6.2, Oldenburg 5.8, Grimes Golden 4.8, Missouri Pippin 4.2, Gano 4.0. Wisconsin.—Oldenburg 14.7, Wealthy 13.7, Northwestern Greening 11.1, Fameuse (Snow) 8.0, Wolf River 7.5, Ben Davis 5.1, Golden Russet 4.2. Maryland.—Ben Davis 17.0, York Imperial 16.2, Baldwin 8.8, Winesap 7.6, Stayman Winesap 7.0, Arkansas 4.4, Early Harvest 4.2. New Jersey.—Baldwin 25.2, Ben Davis 14.5, Rome Beauty 5.0, Early Harvest 4.7, Rhode Island Greening 4.3, Northern Spy 4.2. Vermont.—Baldwin 15.1, Rhode Island Greening 12.8, Northern Spy 12.0, Fameuse (Snow) 8.1, McIntosh 6.1, Ben Davis 5.6, Yellow Bellflower 4.2. Connecticut.—Baldwin 42.2, Rhode Island Greening 16.9, Golden Russet 5.2. New Hampshire.—Baldwin 51.9, Rhode Island Greening 5.9, Northern Spy 5.2, McIntosh 4.4. Idaho.—Jonathan 21.3, Rome Beauty 16.6, Ben Davis 13.1, Gano 7.8, Winesap 4.6. Oklahoma.—Ben Davis 25.8, Missouri Pippin 12.1, Jonathan 8.2, Winesap 8.1, Arkansas Black 5.6, Gano 4.0. Georgia.—Horse 14.3, Ben Davis 12.2, Red June 10.0, Lambertwig 8.8, Winesap 7.6, Early Harvest 6.1, Arkansas Black 1.6.

PEACHES.

TABLE 141.—Peaches: Production and prices, by States, 1917 and 1918.

State.	Production (000 omitted).		Prices.			
	1918	1917	1918		1917	
			Oct. 15.	Sept. 15.	Oct. 15.	Sept. 15.
	<i>Bushels.</i>	<i>Bushels.</i>	<i>Dollars.</i>	<i>Dollars.</i>	<i>Dollars.</i>	<i>Dollars.</i>
New Hampshire.....	0	47			2.00	1.85
Massachusetts.....	9	145			2.00	2.00
Rhode Island.....	2	20		4.75	1.75	1.80
Connecticut.....	15	268			1.85	1.70
New York.....	1,167	2,244	3.75	3.10	1.40	1.40
New Jersey.....	792	871	2.60	2.80	1.90	1.70
Pennsylvania.....	1,210	1,440	2.60	2.75	1.80	1.70
Delaware.....	284	647				1.25
Maryland.....	600	975	2.00	2.40		1.20
Virginia.....	578	800	2.50	1.80	1.90	1.60
West Virginia.....	850	608	2.45	1.80	2.05	1.75
North Carolina.....	1,035	1,541	1.85	1.60	1.00	1.25
South Carolina.....	1,064	1,130		1.67		1.20
Georgia.....	6,746	4,716	1.65	1.50	2.50	1.60
Florida.....	264	122				
Ohio.....	348	496	3.20	3.00	2.00	2.15
Indiana.....	92	592	3.00	3.40	2.10	2.10
Illinois.....	78	364	3.15	3.50	2.00	1.95
Michigan.....	248	744	3.35	3.30	2.00	2.00
Iowa.....	0	30	3.75	3.30	2.10	2.20
Missouri.....	0	890	2.10	3.30	1.95	1.35
Nebraska.....	0	0	3.25	3.30	2.00	2.35
Kansas.....	0	121		3.50	2.00	1.95
Kentucky.....	110	1,034	1.60	2.75	1.60	1.50
Tennessee.....	840	900	1.70	1.70	1.60	1.20
Alabama.....	3,142	1,830		1.10	1.30	1.45
Mississippi.....	1,386	375		1.50		1.20
Louisiana.....	615	478		1.90		1.50
Texas.....	2,041	2,352	2.00	1.75	1.70	1.70
Oklahoma.....	303	1,150	1.90	1.90	1.40	1.35
Arkansas.....	260	840	1.67	1.90		1.25
Colorado.....	754	1,200		2.00	1.20	2.00
New Mexico.....	85	60	2.45	2.35		1.95
Arizona.....	58	60	2.80	2.90	2.40	1.95
Utah.....	1,080	900	1.40	1.50	1.30	1.30
Nevada.....	15	6				
Idaho.....	80	165		1.90	1.20	1.20
Washington.....	1,130	504	1.75	1.60	1.25	1.00
Oregon.....	118	250	2.00	2.00	1.50	1.10
California.....	11,570	14,151	1.45	1.40	1.00	1.00
United States.....	38,969	45,066	1.93	1.66	1.61	1.36

TABLE 142.—Peaches: Production (bushels) in the United States, 1899–1918.

Year.	Production.	Year.	Production.	Year.	Production.
1899 ¹	15,433,000	1906.....	44,104,000	1913.....	39,707,000
1900.....	49,438,000	1907.....	22,527,000	1914.....	54,109,000
1901.....	46,445,000	1908.....	48,145,000	1915.....	64,097,000
1902.....	37,831,000	1909 ¹	55,470,000	1916.....	37,505,000
1903.....	28,850,000	1910.....	48,171,000	1917.....	45,066,000
1904.....	41,070,000	1911.....	34,880,000	1918.....	38,969,000
1905.....	36,634,000	1912.....	52,343,000		

¹ Census figures.

PEACHES—Continued.

TABLE 143.—*Peaches: Farm price, cents per bushel, 15th of month, 1910–1918.*

Date.	1918	1917	1916	1915	1914	1913	1912	1911	1910
Apr. 15.....									130.0
May 15.....									152.0
June 15.....	134.0	170.3	119.6				119.2		135.0
July 15.....	169.4	144.8	109.1	99.5	120.4	130.5	112.1		151.0
Aug. 15.....	178.9	143.3	114.9	85.4	105.0	126.2	108.3		138.0
Sept. 15.....	185.3	143.8	118.3	81.1	102.2	136.3	110.0		129.0
Oct. 15.....	193.2	160.6	112.1	85.2	105.3	145.0	105.0		131.0
Nov. 15.....									125.0
Dec. 15.....									142.0

TABLE 144.—*Estimated production of the commercial peach crop, 1917 and 1918.*

State.	1918	1917	State.	1918	1917
	<i>Bushels.</i>	<i>Bushels.</i>		<i>Bushels.</i>	<i>Bushels.</i>
New Hampshire.....	0	14,000	Missouri.....	0	228,000
Massachusetts.....	0	36,000	Kentucky.....	0	55,000
Connecticut.....	0	273,000	Tennessee.....	107,000	45,000
New York.....	525,000	3,617,000	Alabama.....	127,000	64,000
New Jersey.....	640,000	711,000	Mississippi.....	0	0
Pennsylvania.....	284,000	665,000	Texas.....	711,000	484,000
Delaware.....	101,000	282,000	Oklahoma.....	77,000	288,000
Maryland.....	144,000	439,000	Arkansas.....	90,000	1,005,000
Virginia.....	66,000	119,000	Colorado.....	719,000	822,000
West Virginia.....	459,000	675,000	New Mexico.....	27,000	99,000
North Carolina.....	90,000	150,000	Utah.....	735,000	956,000
South Carolina.....	102,000	113,000	Idaho.....	42,000	158,000
Georgia.....	3,255,000	1,512,000	Washington.....	402,000	1,223,000
Ohio.....	87,000	188,000	Oregon.....	31,000	114,000
Indiana.....	0	30,000	California ¹	11,663,000	14,151,000
Illinois.....	0	87,000	Total.....	20,546,000	28,901,000
Michigan.....	62,000	298,000			

¹ Attention is called to the fact that approximately 88 per cent of the California peach crop is either canned or dried.

PEARS.

TABLE 145.—*Pears: Production and prices, 1917 and 1918.*

State.	Production (000 omitted).		Prices Nov. 15.		State.	Production (000 omitted).		Prices Nov. 15.	
	1918	1917	1918	1917		1918	1917	1918	1917
	<i>Bu.</i>	<i>Bu.</i>	<i>Dolls.</i>	<i>Dolls.</i>		<i>Bu.</i>	<i>Bu.</i>	<i>Dolls.</i>	<i>Dolls.</i>
Maine.....	20	24			Nebraska.....	6	14		1.75
New Hampshire.....	15	19			Kansas.....	38	140	2.00	1.70
Vermont.....	13	14			Kentucky.....	140	204	1.75	1.25
Massachusetts.....	77	71			Tennessee.....	112	75	1.50	1.70
Rhode Island.....	10	7	1.75		Alabama.....	152	80	1.30	1.50
Connecticut.....	34	29	1.75		Mississippi.....	136	30	1.05	1.05
New York.....	1,352	1,708	1.50	1.40	Louisiana.....	52	52	1.20	1.15
New Jersey.....	650	590	1.10	.75	Texas.....	246	280	1.50	1.60
Pennsylvania.....	518	448	1.35	1.20	Oklahoma.....	38	45	2.40	1.50
Delaware.....	238	294	.80	.65	Arkansas.....	64	102	1.80	1.25
Maryland.....	455	525	1.00	.70	Montana.....	6	11		
Virginia.....	119	194	1.20	1.15	Louisiana.....	194	320	1.50	2.10
West Virginia.....	33	33	2.00	1.35	New Mexico.....	56	46		
North Carolina.....	108	150	1.50	1.25	Arizona.....	19	21	3.84	
South Carolina.....	98	100	1.40	1.25	Utah.....	51	48	1.60	1.20
Georgia.....	188	140	1.50	1.35	Nevada.....	6	6		
Florida.....	132	46		1.00	Idaho.....	60	70	1.50	1.50
Ohio.....	304	334	1.70	1.25	Washington.....	630	595	1.15	1.15
Indiana.....	260	410	1.75	1.00	Oregon.....	672	600	1.25	1.30
Illinois.....	302	456	1.60	.95	California.....	1,890	3,523	1.40	1.00
Michigan.....	704	1,080	1.25	1.21	United States..	10,342	13,281	1.37	1.16
Iowa.....	32	82		1.45					
Missouri.....	112	265	1.90	1.25					

PEARS—Continued.

TABLE 146.—Pears: Production (bushels) in the United States, 1909–1918.

Year.	Production.	Year.	Production.
1909 ¹	8,841,000	1914.....	12,086,000
1910.....	10,431,000	1915.....	11,216,000
1911.....	11,450,000	1916.....	11,874,000
1912.....	11,843,000	1917.....	13,281,000
1913.....	10,108,000	1918.....	10,342,000

¹ Census figures.

TABLE 147.—Pears: Farm price, cents per bushel, 15th of month, 1910–1918.

Date.	1918	1917	1916	1915	1914	1913	1912	1911	1910
Jan. 15.....		119.8	92.4	100.4	113.3	108.0			113.5
Feb. 15.....									106.4
Mar. 15.....								108.9	138.2
Apr. 15.....								134.0	130.5
May 15.....								138.6	139.6
June 15.....							113.2	126.0	
July 15.....							122.0	128.0	100.6
Aug. 15.....	108.4	132.2	109.0	80.8	98.8	109.9	106.3	118.0	
Sept. 15.....	157.8	125.0	102.7	83.8	92.8	119.3	100.0	104.0	100.9
Oct. 15.....	147.5	118.2	96.9	82.7	80.4	95.6	83.1	97.2	98.6
Nov. 15.....	140.1	116.1	93.3	89.8	78.5	93.0	79.3	85.1	100.8
Dec. 15.....	156.6		105.6	89.7	82.5	97.9	92.8	111.0	122.4

ORANGES.

TABLE 148.—Oranges: Production and prices, 1915–1918.

Year.	United States.			Florida.			California.		
	Production (000 omitted).	Average price per box Dec. 1.	Farm value Dec. 1, (000 omitted).	Production (000 omitted).	Average price per box Dec. 1.	Farm value Dec. 1, (000 omitted).	Production (000 omitted).	Average price per box Dec. 1.	Farm value Dec. 1, (000 omitted).
1915.....	Boxes. 21,200	\$2.39	\$50,692	Boxes. 6,150	\$1.88	\$11,562	Boxes. 15,050	\$2.60	\$39,130
1916.....	24,433	2.52	61,463	6,933	2.05	14,213	17,500	2.70	47,250
1917.....	10,593	2.60	27,556	3,500	2.30	8,050	7,093	2.75	19,506
1918.....	19,587	4.73	92,723	5,265	2.65	13,952	14,322	5.50	78,771

TABLE 149.—Oranges: Farm price per box on 1st of month, 1908–1918.

FLORIDA.

Date.	1918	1917	1916	1915	1914	1913	1912	1911	1910	1909	1908
Jan. 1.....	\$2.55	\$1.82	\$1.59								
Feb. 1.....	2.00	1.74	1.65	\$1.36							
Mar. 1.....	2.54	1.81	1.78	1.37	\$1.53	\$1.87	\$1.78	\$1.64	\$1.50	\$1.23	\$1.57
Apr. 1.....	3.38	2.45	1.74	1.35	1.83	1.96	2.08	2.18	1.69	1.77	1.46
May 1.....	5.00	2.85	2.15	1.40	2.02	2.41	2.20	1.94	2.07	1.93	1.53
June 1.....			1.71	2.00	1.86	2.54	2.62	1.91	2.16	1.97	1.78
July 1.....	4.44		2.50	1.80	2.25	2.95	2.08	2.28	2.62	1.84	1.53
Aug. 1.....	4.17	2.83	2.30	2.58	1.75	3.19	2.79	1.79	2.10		1.30
Sept. 1.....	3.16	1.75	2.04	2.25	2.55	2.00	3.25	2.08	2.20	1.53	1.72
Oct. 1.....		2.62	1.39	1.70		1.69	1.76	1.70	1.88	1.22	1.43
Nov. 1.....	3.43	2.16	1.81	1.70		2.02	1.75	1.49	1.80	1.78	1.39
Dec. 1.....	2.65	2.30	2.05	1.88	1.21	1.50		1.60	1.50	1.23	1.20

CALIFORNIA.

Jan. 1.....	\$2.23	\$1.63	\$1.42								
Feb. 1.....	3.00	1.79	1.68	\$1.26							
Mar. 1.....	4.00	1.90	1.80	1.43	\$1.97	\$1.86	\$1.72				
Apr. 1.....	2.99	2.21	1.30	1.53	1.50	2.56	1.92				
May 1.....	3.84	1.84	1.68	1.42	1.67	2.78	2.16				
June 1.....	2.63	2.02	1.88	1.97	1.55	2.50	1.83				
July 1.....	2.86	1.97	2.20	1.50	1.40	2.61	1.84				
Aug. 1.....	5.00	2.25	3.30	1.55	1.94	4.71	1.68				
Sept. 1.....	4.44	2.40	3.06	1.75	2.15	3.75	1.89	\$2.00			
Oct. 1.....	3.75	2.60	3.43	2.00	2.30	3.25	1.62	2.21			
Nov. 1.....	8.54	1.97	3.30	2.50	2.08	3.08	2.05	2.19			
Dec. 1.....	5.50	2.75	2.70	2.60	2.00	3.30					

CRANBERRIES.

TABLE 150.—Cranberries: Acreage, production, and farm value, by States, 1918, and totals (three States), 1914–1918.

[Leading producing States.]

State and year.	Acreage.	Average yield per acre.	Production.	Average farm price per barrel Dec. 1.	Farm value Dec. 1.
	<i>Acres.</i>	<i>Barrels.</i>	<i>Barrels.</i>	<i>Dollars.</i>	<i>Dollars.</i>
Massachusetts.....	14,000	14.3	200,000	12.50	2,500,000
New Jersey.....	11,000	10.4	114,000	8.50	969,000
Wisconsin.....	2,200	16.4	36,100	9.00	325,000
Total of above.....	27,200	12.9	350,100	10.84	3,794,000
1917.....	18,200	13.7	249,000	10.24	2,550,000
1916.....	26,500	18.0	471,000	7.32	3,449,000
1915.....	23,100	19.1	441,000	6.59	2,908,000
1914.....	22,000	31.7	697,000	3.97	2,766,000

HOPS.

TABLE 151.—Hops: Area and production of undermentioned countries, 1915–1917.

Country.	Area.			Production.		
	1915	1916	1917	1915	1916	1917
NORTH AMERICA.						
United States.....	<i>Acres.</i> 44,700	<i>Acres.</i> 43,900	<i>Acres.</i> 29,900	<i>Pounds.</i> 52,986,000	<i>Pounds.</i> 50,595,900	<i>Pounds.</i> 29,388,000
Canada ¹	1,164			1,208,450		
Total.....	45,864			54,194,450		
EUROPE.						
Austria-Hungary:						
Austria ²	41,043			20,479,000		
Hungary.....	³ 5,444			2,755,750		
Croatia-Slavonia.....	³ 751			³ 292,991		
Total Austria-Hungary...	47,238			23,527,741		
Belgium ⁴	6,140			7,560,000		
France.....	5,471	5,379	4,094	4,809,000	4,957,704	3,936,975
Germany.....	58,654			32,106,751		
Russia ⁵				10,472,712		
United Kingdom: England.....	34,744	31,352	16,946	28,516,208	34,479,872	24,720,528
Total.....				107,091,912		
AUSTRALASIA.						
Australia.....	1,545	1,575	1,331	1,798,048	2,110,304	1,752,240
Grand total.....				163,084,410		

¹ Census figures for 1910.² Galicia and Bukowina not included.³ Data for 1913.⁴ Data for 1914.⁵ Excluding Poland.

HOPS—Continued.

TABLE 152.—Hops: Total production of countries named in Table 120, 1895–1915.

Year.	Production.	Year.	Production.	Year.	Production.
	<i>Pounds.</i>		<i>Pounds.</i>		<i>Pounds.</i>
1895.....	204,894,000	1902.....	170,063,000	1909.....	128,173,000
1896.....	168,509,000	1903.....	174,457,000	1910.....	188,951,000
1897.....	189,219,000	1904.....	178,802,000	1911.....	163,810,000
1898.....	166,100,000	1905.....	277,260,000	1912.....	224,493,000
1899.....	231,563,000	1906.....	180,998,000	1913.....	174,642,000
1900.....	174,683,000	1907.....	215,923,000	1914.....	224,179,000
1901.....	201,902,000	1908.....	230,220,000	1915.....	163,084,410

TABLE 153.—Hops: Acreage, production, and value by States in 1918, and totals (four States), 1915–1918.

[Leading producing States.]

State and year.	Acreage.	Average yield per acre.	Production.	Average farm price per pound Dec. 1.	Farm value Dec. 1.
	<i>Acres.</i>	<i>Pounds.</i>	<i>Pounds.</i>	<i>Cents.</i>	<i>Dollars.</i>
New York.....	3,800	330	1,254,000	22.5	282,000
Washington.....	3,100	948	2,939,000	15.0	441,000
Oregon.....	10,000	350	3,500,000	21.0	735,000
California.....	11,000	1,136	12,500,000	20.0	2,500,000
Total.....	27,900	723.8	20,193,000	19.6	3,958,000
1917.....	29,900	982.9	29,388,000	33.3	9,795,000
1916.....	43,900	1,152.5	50,595,000	12.0	6,073,000
1915.....	44,653	1,186.6	52,986,000	11.7	6,203,000

TABLE 154.—Hops: Farm price, cents per pound, 15th of month, 1910–1918.

Date.	1918	1917	1916	1915	1914	1913	1912	1911	1910
Jan. 15.....		11.8	13.0	14.8	26.6	19.7	44.8	19.3	23.4
Feb. 15.....			12.0	11.1	19.1	16.9	38.8	17.8	22.6
Mar. 15.....			13.5	12.0	20.5		40.1	19.2	18.4
Apr. 15.....			14.3	12.4	20.6	15.0		18.2	20.4
May 15.....			12.7	10.9	21.8	13.4	37.2	20.9	16.6
June 15.....			10.5	9.6		14.1		22.6	
July 15.....		10.7	10.1	10.5	14.7	14.8	28.9	25.8	
Aug. 15.....		25.9		15.0	20.0		18.8	36.5	
Sept. 15.....		36.5	16.4	15.8	24.4	20.9	19.8	49.6	
Oct. 15.....	12.7	42.7	21.0	14.8	19.1	29.5	22.2	37.8	13.3
Nov. 15.....	19.7	33.7	21.5	13.8	15.6	26.0	19.7	41.4	14.2
Dec. 15.....	19.6	33.3	12.0	12.3	13.2	29.4	17.8	42.5	14.6

HOPS—Continued.

TABLE 155.—Hops: Wholesale price per pound, 1913-1918.

Date.	New York, choice State.			Cincinnati, prime.			Chicago, Pacific Coast, good to choice.			San Francisco.								
										Sacramento Valley, choice.			Willamette Valley, choice. ¹			Eastern Washington, choice. ²		
	Low.	High.	Average.	Low.	High.	Average.	Low.	High.	Average.	Low.	High.	Average.	Low.	High.	Average.	Low.	High.	Average.
1913.																		
Jan.-June.....	Cents. 17	Cents. 32	Cents.	Cents. 18	Cents. 23	Cents.	Cents. 15	Cents. 24	Cents.	Cents. 18	Cents. 20	Cents.	Cents. 19	Cents. 21	Cents.	Cents. 19	Cents. 21	Cents.
July-Dec.....	17	48	18	32	17	31	18	28	18	30	19	30
1914.																		
Jan.-June.....	36	48	21	27½	18	27	16	28	16	30	16	30
July-Dec.....	23	50	13½	22	13	22	10	19	11	20	10	20
1915.																		
Jan.-June.....	13	25	16	17	10	18	09	15	10	16	10	15
July-Dec.....	13	30	15½	16	10	16	07½	14	10	16	10	15
1916.																		
Jan.-June.....	18	27	14	15½	14	17	07½	11	09	12½	09	12½
July-Dec.....	15	55	13	16½	10	18	08	14	07	14	07	14
1917.																		
January.....	45	50	14	15	13	15	09	10½	07	11	09	11½
February.....	45	47	14	15	12	14	08	10½	07	11	09	11½
March.....	39	42	13	14	12	14	06	10	07	11	08	11½
April.....	38	42	12	13	10	13	05	09	07	11	06	11
May.....	34	42	12	13	10	12	05	09	07	11	06	10
June.....	34	38	11	12	10	12	05	09	07	11	06	10
Jan.-June.....	34	50	11	15	10	15	05	10½	07	11	06	11½
1918.																		
July.....	34	40	13	16	10	12	05	10	07	12	06	11
August.....	38	40	16	26	22	25	12	27½	12	30	13	30
September.....	88	90	25	40	42	46	27½	30	30
October.....	78	90	40	43	33	37	30	37½	32½	40	32½	40

November.....	70	78	32	38	26	20	20	30	20	32½	22½	32½	
December.....	53	70	30	32	24	28	20	20	22½	22½	20	20	
July-Dec.....	34	90	13	43	10	46	05	37½	07	40	06	40	
1918.																			
January.....	42	54	50.1	21	24	20	20	20.0	20	20	20.0	22½	22½	22.5	
February.....	40	45	41.6	20	23	15	20	16.6	15	20	18.4	19	22½	20.1	
March.....	40	42	41.0	21	24	15	15	15.0	15	19	18.7	19	19	19.0	
April.....	40	42	41.0	21	24	15	15	15.0	19	19	19.0	19	19	19.0	
May.....	40	42	41.0	20	23	15	15	15.0	19	19	19.0	19	19	19.0	
June.....	40	42	41.0	18	21	15	15	15.0	19	19	19.0	19	19	19.0	
Jan.-June.....	40	54	42.6	18	24	15	20	16.1	15	20	19.0	19	22½	19.8	
July.....	40	42	41.0	18	21	15	15	15.0	19	19	19.0	19	19	19.0	
August.....	36	42	39.8	19	22	15	15	15.0	19	19	19.0	19	19	19.0	
September.....	23	35	29.1	16	18	15	15	15.0	19	19	19.0	19	19	19.0	
October.....	24	30	25.0	13	23	(3)	(3)	(3)	(3)	(3)	(3)	(3)	(3)	(3)	(3)	
November.....	28	34	31.4	19	30	(3)	(3)	(3)	(3)	(3)	(3)	(3)	(3)	(3)	(3)	
December.....	31	37	33.0	30	40	(3)	(3)	(3)	(3)	(3)	(3)	(3)	(3)	(3)	(3)	
July-Dec.....	23	42	33.2	13	40	15	15	15.0	19	19	19.0	19	19	19.0	

¹ 1912 quotations are for all grades. Called "Oregon" hops in 1916.

² Called "Washington" hops in 1916.

³ No market.

HOPS—Continued.

TABLE 156.—Hops: International trade, calendar years 1909–1917.

[Lupulin and *hopfenmehl* (hop meal) are not included with hops in the data shown. See "General note," Table 93.]

EXPORTS.

[000 omitted.]

Country.	Average, 1909–1913.	1916 (Preliminary).	1917 (Preliminary).	Country.	Average, 1909–1913.	1916 (Preliminary).	1917 (Preliminary).
<i>From—</i>	<i>Pounds.</i>	<i>Pounds.</i>	<i>Pounds.</i>	<i>From—</i>	<i>Pounds.</i>	<i>Pounds.</i>	<i>Pounds.</i>
Austria-Hungary.....	18,333	Russia.....	2,348	542
Belgium.....	4,814	United Kingdom.....	2,162	1,206
France.....	335	1,432	United States.....	15,416	13,506	4,118
Germany.....	17,564	Other countries.....	212
Netherlands.....	1,405	Total.....	62,941
New Zealand.....	352	488				

IMPORTS.

<i>Into—</i>				<i>Into—</i>			
Australia.....	1,106	766	Netherlands.....	2,938
Austria-Hungary.....	938	Russia.....	1,258
Belgium.....	6,915	Sweden.....	987
British India.....	246	Switzerland.....	1,257	779
British South Africa.....	498	439	432	United Kingdom.....	21,028	16,369
Canada.....	1,396	781	790	United States.....	6,235	631	194
Denmark.....	1,027	Other countries.....	4,123
France.....	5,436	709	Total.....	63,076
Germany.....	7,688				

BEANS.

TABLE 157.—Beans: Area and production of undermentioned countries, 1915–1917.

Country.	Area.			Production.		
	1915	1916	1917	1915	1916	1917
NORTH AMERICA.						
United States (6 States).....	<i>Acres.</i> 1,928,000	<i>Acres.</i> 1,107,000	<i>Acres.</i> 1,769,000	<i>Bushels.</i> 110,321,000	<i>Bushels.</i> 10,715,000	<i>Bushels.</i> 15,283,000
Canada:						
Nova Scotia.....	1,000	1,000	1,000	15,000	14,000	18,000
New Brunswick.....	(²)	(²)	(²)	6,000	4,000	6,000
Quebec.....	5,000	4,000	55,000	103,000	78,000	827,000
Ontario.....	38,000	27,000	36,000	600,000	317,000	423,000
Total Canada.....	44,000	32,000	92,000	724,000	413,000	1,274,000
SOUTH AMERICA.						
Argentina.....	72,000
Brazil.....	(³)	410,000	41,675,000
Chile.....	106,000	1,876,000	1,914,000

¹ Five States.² Less than 500 acres.³ No official estimates.⁴ Exports.

BEANS—Continued.

TABLE 157.—Beans: Area and production of undermentioned countries, 1915–1917—Con.

Country.	Area.			Production.		
	1915	1916	1917	1915	1916	1917
EUROPE.						
Austria-Hungary:	<i>Acres.</i>	<i>Acres.</i>	<i>Acres.</i>	<i>Bushels.</i>	<i>Bushels.</i>	<i>Bushels.</i>
Austria ¹	2 664,000			2 8,725,000		
Hungary ³	2 28,000			2 393,000		
Do. ⁴	2 1,471,000			2 7,865,000		
Croatia-Slavonia ³	2 24,000			2 337,000		
Do. ⁴	2 411,000			2 1,760,000		
Total Austria-Hungary	2 2,598,000			2 19,080,000		
Belgium ⁵	20,000			514,000		
Bulgaria ⁵	212,000			2,482,000		
Denmark.....	7,000	11,000		192,000	269,000	
France.....	6 494,000	489,000	484,000	6 8,177,000	6,053,000	5,955,000
Italy.....	2,702,000	2,555,000		24,629,000	17,372,000	
Luxemburg.....	2 3,000			2 61,000		
Netherlands.....	58,000	59,000	92,000	1,905,000	1,742,000	2,526,000
Roumania ³	186,000	188,000		1,993,000		
Do. ⁴	1,455,000			3,573,000		
Russia:⁷						
Russia proper.....	6 978,000	6 744,000		6 8,373,000	6 7,758,000	
Northern Caucasia.....	3,000			48,000	(8)	
Total European Russia	981,000			8,421,000		
Serbia ⁵	30,000			1,491,000		
Spain.....	1,201,000	1,225,000			14,755,000	
Sweden.....	6,000	6,000	5,000	125,000	195,000	91,000
United Kingdom:						
England.....	257,000	228,000	202,000	7,353,000	6,871,000	3,462,000
Wales.....	1,000	1,000	1,000	29,000	28,000	29,000
Scotland.....	5,000	5,000	6,000	202,000	196,000	237,000
Ireland.....	1,000	1,000	1,000	42,000	46,000	65,000
Total United Kingdom	264,000	235,000	211,000	7,626,000	7,141,000	3,793,000
ASIA.						
British India ¹	13,778,000	13,224,000	14,238,000	9 143,397,000	9 127,979,000	9 147,467,000
Japanese Empire:						
Japan.....	1,587,000	1,584,000		27,026,000	26,484,000	
Formosa ¹	89,000	88,000		786,000	780,000	
Korea.....	1,577,000			18,083,000		
Total Japanese Empire	3,253,000			45,895,000		
Russia (9 governments).....	3,000			21,000		
AFRICA.						
Algeria ⁵	136,000			1,022,000		
Egypt.....	647,000	522,000				
AUSTRALASIA.						
Australia.....	(10)	1,000	1,000	(10)	10,000	19,000

1 Includes other pulse.
 2 1913 figures.
 3 Grown alone.
 4 Grown with corn.
 5 1912 figures.

6 Excludes territory occupied by the enemy.
 7 Includes lentils.
 8 No official estimates.
 9 Incomplete.
 10 Included under peas.

BEANS—Continued.

TABLE 158.—Beans: Acreage, production, and value by States, 1918, and totals (six States), 1914–1918.

[Leading producing States.]

State and year.	Acreage.	Average yield per acre.	Production.	Average farm price per bushel Dec. 1.	Farm value Dec. 1.
	<i>Acres.</i>	<i>Bushels.</i>	<i>Bushels.</i>	<i>Dollars.</i>	<i>Dollars.</i>
New York.....	200,000	8.3	1,660,000	6.70	11,122,000
Michigan.....	543,000	9.0	4,887,000	5.00	24,435,000
Colorado.....	252,000	6.5	1,638,000	4.40	7,207,000
New Mexico.....	149,000	4.0	596,000	4.30	2,563,000
Arizona.....	18,000	4.0	72,000	5.00	360,000
California.....	592,000	15.0	8,880,000	5.40	47,952,000
Total.....	1,754,000	10.1	17,733,000	5.28	93,639,000
1917.....	1,821,000	8.8	16,045,000	6.50	104,350,000
1916.....	1,107,000	9.7	10,715,000	5.10	54,686,000
1915.....	928,000	11.1	10,321,000	2.59	26,771,000
1914.....	875,000	13.2	11,585,000	2.26	26,213,000

TABLE 159.—Beans: Farm price per bushel, 15th of month, 1910–1918.

Date.	1918	1917	1916	1915	1914	1913	1912	1911	1910
Jan. 15.....	\$7.00	\$5.71	\$3.47	\$2.63	\$2.17	\$2.26	\$2.38	\$2.20	\$2.23
Feb. 15.....	7.08	6.07	3.43	3.02	2.09	2.19	2.38	2.23	2.23
Mar. 15.....	6.95	6.49	3.34	2.89	2.05	2.10	2.42	2.17	2.17
Apr. 15.....	6.95	7.37	3.42	2.81	2.11	2.11	2.37	2.20	2.16
May 15.....	6.67	8.94	3.56	2.93	2.31	2.18	2.52	2.17	2.17
June 15.....	6.28	8.99	3.72	2.87	2.23	2.23	2.62	2.19	2.29
July 15.....	5.88	8.07	5.09	2.75	2.22	2.22	2.47	2.23	2.34
Aug. 15.....	6.11	7.29	4.59	2.67	2.54	2.11	2.40	2.20	2.27
Sept. 15.....	5.67	6.69	4.60	2.70	2.46	2.08	2.38	2.26	2.28
Oct. 15.....	5.52	7.48	4.47	2.93	2.17	2.25	2.34	2.27	2.25
Nov. 15.....	5.46	7.33	5.53	3.03	2.28	2.20	2.25	2.34	2.14
Dec. 15.....	4.86	7.00	5.77	3.30	2.40	2.12	2.30	2.42	2.20

TABLE 160.—Soy beans: Farm price per bushel, 15th of month, 1913–1918.

Date.	1918	1917	1916	1915	1914	1913
Jan. 15.....	\$3.47	\$2.20	\$2.31	\$2.35	\$1.96
Feb. 15.....	3.82	2.45	2.39	2.26	1.80
Oct. 15.....	3.36	2.73	2.13	1.88	2.08	\$1.96
Nov. 15.....	3.20	2.86	2.13	2.08	2.15	1.57
Dec. 15.....	3.29	3.33	2.18	2.23	2.24	1.72

BEANS—Continued.

TABLE 161.—Beans: Wholesale price per bushel, 1913-1918.

Date.	Boston, pea.			Chicago, pea.			Detroit, pea.			San Francisco small white (per 100 lbs.).		
	Low.	High.	Average.	Low.	High.	Average.	Low.	High.	Average.	Low.	High.	Average.
1913.	<i>Dolls.</i>	<i>Dolls.</i>	<i>Dolls.</i>	<i>Dolls.</i>	<i>Dolls.</i>	<i>Dolls.</i>	<i>Dolls.</i>	<i>Dolls.</i>	<i>Dolls.</i>	<i>Dolls.</i>	<i>Dolls.</i>	<i>Dolls.</i>
Jan.-June.....	2.25	2.60	2.45	1.25	2.50	1.86	1.80	2.20	4.50	5.90	4.91
July-Dec.....	2.15	2.40	2.28	1.15	2.25	1.76	1.75	2.05	4.50	6.00	5.41
1914.												
Jan.-June.....	2.10	2.35	2.20	1.60	2.30	1.99	1.80	2.10	4.75	5.50	5.15
July-Dec.....	2.15	3.10	2.59	1.95	3.10	2.44	1.85	2.90	4.00	6.00	4.81
1915.												
Jan.-June.....	2.95	3.50	3.24	2.40	3.50	3.08	2.15	3.20	2.98	4.50	5.70	5.40
July-Dec.....	2.85	4.10	3.47	2.62	4.10	3.30	2.60	3.60	3.15	4.50	6.40	5.19
1916.												
Jan.-June.....	3.80	5.85	4.08	3.00	8.00	3.94	3.50	6.00	3.86	6.25	11.50	6.70
July-Dec.....	4.50	7.25	5.83	5.00	8.00	6.34	4.90	7.00	5.77	7.50	11.00	9.40
1917.												
January.....	6.50	6.90	6.77	6.40	6.80	6.66	6.25	6.65	6.42	10.50	11.00	10.75
February.....	6.90	7.50	7.18	6.75	7.50	7.08	6.45	7.25	6.88	10.50	12.00	10.91
March.....	7.35	7.85	7.75	7.35	8.00	7.72	7.25	7.60	7.46	11.50	12.50	12.14
April.....	7.85	9.25	8.48	7.60	11.00	8.98	7.80	10.00	8.89	12.25	16.00	13.94
May.....	9.00	10.25	9.84	9.75	11.25	10.59	9.00	10.00	9.49	15.00	16.00	15.88
June.....	9.00	10.00	9.38	9.50	10.00	9.80	8.00	9.00	8.68	15.00	16.00	15.62
Jan.-June.....	6.50	10.25	8.23	6.40	11.25	8.47	6.25	10.00	7.97	10.50	16.00	13.21
July.....	8.75	9.25	8.90	8.75	10.00	8.95	7.90	8.25	8.20	14.00	15.75	14.38
August.....	8.00	8.50	8.25	7.25	8.60	8.15	7.25	8.00	7.65	13.75	14.00	13.89
September.....	8.00	8.35	8.22	7.25	8.00	7.58	7.25	8.00	7.60	12.75	13.75	13.63
October.....	8.25	9.25	8.82	7.85	9.50	8.84	8.25	9.25	8.76	12.50	13.25	12.94
November.....	9.25	15.00	12.97	8.75	14.50	10.87	8.00	13.25	10.75	12.25	12.50	12.38
December.....	14.00	14.75	14.43	13.25	14.50	13.89	12.10	13.25	12.49	11.75	12.25	11.95
July-Dec.....	8.00	15.00	10.26	7.25	14.50	9.71	7.25	13.25	9.21	11.75	15.75	13.20
1918.												
January.....	13.00	14.25	13.90	13.00	15.00	13.32	12.10	12.50	11.32	11.75	12.00	11.98
February.....	13.00	14.00	13.31	13.00	15.00	13.82	12.50	13.25	11.71	12.00	12.75	12.28
March.....	12.00	14.50	14.01	13.00	14.50	13.60	11.75	13.25	11.63
April.....	12.00	14.00	13.62	12.00	13.25	12.59	11.50	11.75	11.51	12.50	12.50	12.50
May.....	12.00	13.50	12.95	10.00	12.50	11.77	10.00	11.50	10.79	12.50	12.50	12.50
June.....	12.00	13.00	12.44	10.00	11.50	10.54	9.50	10.00	9.87	12.50	12.50	12.50
Jan.-June.....	12.00	14.50	13.37	10.00	15.00	12.61	9.50	13.25	11.64	11.75	12.75	12.35
July.....	11.50	12.00	12.11	10.00	12.50	11.30	9.25	10.00	9.56	12.00	12.25	12.16
August.....	11.50	12.00	11.75	10.50	12.00	11.24	9.00	10.25	10.07	12.00	12.25	12.12
September.....	9.50	12.00	10.71	10.50	11.00	10.75	9.00	9.00	9.00	11.25	12.25	11.33
October.....	9.50	11.00	10.25	8.25	11.00	10.01	8.75	9.75	9.09	10.75	11.75	11.19
November.....	9.50	11.00	10.25	9.50	10.25	9.78	8.65	9.00	8.89	9.35	11.00	9.52
December.....	9.00	10.50	9.63	9.00	10.00	9.15	9.00	9.00	9.00	8.90	9.40	9.32
July-Dec.....	9.00	12.00	10.78	8.25	12.50	10.37	8.65	10.25	9.27	8.90	12.25	10.94

PEAS.

TABLE 162.—Peas: Area and production of undermentioned countries, 1915–1917.

Country.	Area.			Production.		
	1915	1916	1917	1915	1916	1917
NORTH AMERICA.						
United States.....	¹ 1,305,000	⁽²⁾	⁽³⁾	¹ 7,129,000	⁽²⁾	⁽³⁾
Canada:						
Prince Edward Island.....	⁽³⁾	⁽³⁾	⁽³⁾	1,000	1,000	1,000
Nova Scotia.....	⁽³⁾	⁽³⁾	⁽³⁾	4,000	3,000	2,000
New Brunswick.....	⁽³⁾	⁽³⁾	⁽³⁾	7,000	7,000	6,000
Quebec.....	24,000	22,000	66,000	404,000	302,000	798,000
Ontario.....	169,000	126,000	126,000	3,007,000	1,796,000	2,110,000
Saskatchewan.....	1,000	2,000	3,000	8,000	52,000	45,000
Alberta.....	⁽³⁾	1,000	2,000	3,000	13,000	32,000
British Columbia.....	1,000	1,000	1,000	39,000	44,000	32,000
Total Canada.....	196,000	152,000	199,000	3,472,000	2,218,000	3,026,000
SOUTH AMERICA.						
Chile ⁴	32,000	36,000		471,000	515,000	
EUROPE.						
Austria.....	⁵ 54,000			⁵ 497,000		
Hungary ⁶	⁷ 30,000			⁷ 426,000		
Croatia-Slavonia ⁸	⁷ 10,000			⁷ 147,000		
Belgium.....	⁸ 12,000			⁸ 400,000		
France ⁹	⁹ 49,000			⁹ 854,000	757,000	463,000
Italy ⁴				3,020,000	2,704,000	
Luxemburg ⁶	⁷ 2,000			⁷ 28,000		
Netherlands.....	61,000	61,000	89,000	1,818,000	1,600,000	2,529,000
Roumania ⁶	44,000	77,000		750,000		
Russia:						
Russia proper.....	⁹ 1,395,000	⁹ 1,070,000		⁹ 13,457,000	⁹ 12,201,000	
Poland.....	⁽²⁾					
Northern Caucasia.....	3,000			73,000		
Total Russia, European.....	1,398,000			13,530,000		
Spain ⁴	1,346,000	1,392,000		11,382,000	13,369,000	
Sweden.....	54,000	55,000		1,150,000	1,123,000	
United Kingdom:						
England.....	98,000	84,000	102,000	2,461,000	2,072,000	2,203,000
Wales.....	⁽³⁾	⁽³⁾	1,000	8,000	9,000	12,000
Scotland.....	⁽³⁾	⁽³⁾	⁽³⁾	3,000	3,000	1,000
Ireland.....	⁽³⁾	⁽³⁾	⁽³⁾	6,000	4,000	8,000
Total United Kingdom.....	98,000	86,000	103,000	2,478,000	2,089,000	2,225,000
ASIA.						
Japan.....	110,000	125,000		2,123,000	2,329,000	
Russia (9 governments).....	82,000			552,000		
AUSTRALASIA.						
Australia.....	¹⁰ 41,000	25,000	32,000	¹⁰ 371,000	404,000	567,000
New Zealand.....	13,000	9,000	12,000	367,000	168,000	242,000

¹ Census for 1909.² No official statistics.³ Less than 500 acres.⁴ Includes chick-peas, lentils, and vetches.⁶ Galicia and Bukowina not included.⁶ Includes lentils.⁷ 1913 figures.⁸ 1912 figures.⁹ Excludes territory occupied by the enemy.¹⁰ Includes beans.

BROOM CORN.

TABLE 163.—Broom corn: Acreage, production, and value, by States, 1918, and totals (five States), 1915–1918.

[Leading producing States.]

State and year.	Acreage.	Average yield per acre.	Production.	Average farm price per ton Dec. 1.	Farm value Dec. 1.
	<i>Acres.</i>	<i>Tons.</i>	<i>Tons.</i>	<i>Dollars.</i>	<i>Dollars.</i>
Illinois.....	31,000	0.290	9,000	400.00	3,600,000
Kansas.....	58,000	.147	8,500	175.00	1,488,000
Texas.....	74,000	.260	19,200	260.00	4,992,000
Oklahoma.....	140,000	.115	16,100	162.00	2,608,000
Colorado.....	30,000	.175	5,200	175.00	910,000
Total.....	333,000	.174	58,000	234.45	13,598,000
1917.....	345,000	.166	57,400	292.75	16,804,000
1916.....	235,200	.165	38,726	172.75	6,690,000
1915.....	230,100	.227	52,242	91.67	4,789,000

TABLE 164.—Broom corn: Farm price per ton, 15th of month, 1910–1918.

Date.	1918	1917	1916	1915	1914	1913	1912	1911	1910
Jan. 15.....	\$249.39	\$184.08	\$103.97	\$66.26	\$94.38	\$48.89	\$99.96	\$81.46	\$189.85
Feb. 15.....	253.70	200.54	103.52	78.44	95.16	56.08	85.97	79.70	196.88
Mar. 15.....	242.47	212.24	103.81	68.42	91.36	56.97	99.36	77.96	199.66
Apr. 15.....	222.19	226.82	96.39	70.79	89.47	58.13	100.54	74.10	203.80
May 15.....	205.98	252.33	100.94	74.84	84.99	53.40	83.34	81.05	199.25
June 15.....	222.11	222.66	101.81	76.51	88.04	61.08	79.40	69.36	150.67
July 15.....	235.02	193.79	103.06	78.94	87.94	56.61	84.68	68.14	179.65
Aug. 15.....	231.68	307.66	119.79	82.96	91.44	90.58	83.12	72.07	142.13
Sept. 15.....	300.28	240.15	128.51	75.24	77.05	106.05	76.52	91.67	138.66
Oct. 15.....	265.23	269.85	167.52	86.44	66.53	101.85	70.40	121.47	107.94
Nov. 15.....	205.35	295.50	172.60	92.04	65.82	99.80	69.33	124.00	95.62
Dec. 15.....	171.63	279.55	171.94	101.19	58.21	92.32	57.07	108.20	93.01

GRAIN SORGHUMS.

TABLE 165.—Grain sorghums:¹ Acreage, production, and value, by States, 1918, and totals (six States), 1915–1918.

[Leading producing States.]

State and year.	Acreage.	Average yield per acre.	Production.	Average farm price per bushel Dec. 1.	Farm value Dec. 1.
	<i>Acres.</i>	<i>Bushels.</i>	<i>Bushels.</i>	<i>Cents.</i>	<i>Dollars.</i>
Kansas.....	2,139,000	9.4	20,107,000	150	30,160,000
Texas.....	1,605,000	15.0	24,075,000	150	36,112,000
Oklahoma.....	1,526,000	10.0	15,260,000	150	22,890,000
Colorado.....	92,000	19.0	1,748,000	146	2,552,000
New Mexico.....	199,000	18.0	3,582,000	150	5,373,000
Arizona.....	58,000	28.0	1,624,000	170	2,761,000
Total.....	5,619,000	11.8	66,396,000	150.4	99,848,000
1917.....	5,153,000	11.9	61,409,000	161.9	99,433,000
1916.....	3,944,000	13.7	53,858,000	105.9	57,027,000
1915.....	4,153,000	27.6	114,460,000	44.7	51,157,000

¹ Kafirs, milo maize, feteritá.

GRAIN SORGHUMS—Continued.

TABLE 166.—*Grain sorghums: Farm price per bushel, 15th of month, 1916–1918.*

Date.	1918	1917	1916		1918	1917	1916
	<i>Cents.</i>	<i>Cents.</i>	<i>Cents.</i>		<i>Cents.</i>	<i>Cents.</i>	<i>Cents.</i>
Jan. 15.....	170.8	119.1	July 15.....	165.6	214.0	62.8
Feb. 15.....	185.7	129.0	Aug. 15.....	177.2	243.3	72.4
Mar. 15.....	147.0	Sept. 15.....	181.0	187.7	83.8
Apr. 15.....	204.0	152.0	53.6	Oct. 15.....	175.9	174.1	80.8
May 15.....	211.0	188.0	58.2	Nov. 15.....	150.5	160.6	102.4
June 15.....	179.6	206.3	60.0	Dec. 15.....	154.8	166.7	101.5

PEANUTS.

TABLE 167.—*Peanuts: Acreage, production, and value, by States, 1918, and totals, 1916–1918.*

State and year.	Acreage.	Average yield per acre.	Production.	Average farm price per bushel Dec. 1.	Farm value Dec. 1.
	<i>Acres.</i>	<i>Bushels.</i>	<i>Bushels.</i>	<i>Cents.</i>	<i>Dollars.</i>
Virginia.....	140,000	42.0	5,880,000	203	11,936,000
North Carolina.....	160,000	45.0	7,200,000	207	14,904,000
South Carolina.....	14,000	45.0	630,000	292	1,840,000
Georgia.....	362,000	28.0	10,136,000	160	16,218,000
Florida.....	153,000	34.0	5,202,000	154	8,011,000
Missouri.....	400	40.0	16,000	240	38,000
Tennessee.....	18,000	38.0	684,000	177	1,211,000
Alabama.....	747,000	23.4	17,480,000	141	24,647,000
Mississippi.....	5,000	31.5	158,000	152	240,000
Louisiana.....	4,500	24.0	108,000	183	198,000
Texas.....	647,000	11.0	7,117,000	206	14,661,000
Oklahoma.....	20,000	22.0	440,000	219	964,000
Arkansas.....	21,000	26.0	546,000	176	961,000
Total.....	2,291,900	24.3	55,597,000	172.4	95,829,000
1917.....	1,842,400	28.5	52,505,000	174.3	91,498,000
1916.....	1,043,350	33.0	34,433,500	120.1	41,357,000

TABLE 168.—*Peanuts: Farm price per pound, 15th of month, 1910–1918.*

Date.	1918	1917	1916	1915	1914	1913	1912	1911	1910
	<i>Cents.</i>	<i>Cents.</i>	<i>Cents.</i>	<i>Cents.</i>	<i>Cents.</i>	<i>Cents.</i>	<i>Cents.</i>	<i>Cents.</i>	<i>Cents.</i>
Jan. 15.....	7.0	4.9	4.3	4.5	4.7	4.6	4.3	4.4	4.9
Feb. 15.....	7.2	5.3	4.4	4.4	4.7	4.5	4.7	5.0	5.4
Mar. 15.....	7.4	5.5	4.4	4.2	4.7	4.7	5.0	4.8	5.0
Apr. 15.....	8.3	6.2	4.6	4.5	4.9	4.8	4.9	4.9	5.4
May 15.....	8.2	7.2	4.6	4.8	5.1	4.7	4.9	4.8	5.2
June 15.....	7.9	7.7	4.7	4.8	5.1	5.0	5.2	5.2	5.4
July 15.....	7.8	7.6	4.6	4.7	5.2	5.1	4.9	5.0	5.2
Aug. 15.....	7.9	7.2	4.6	4.5	4.9	4.9	5.0	5.3	4.5
Sept. 15.....	8.3	6.0	4.4	4.4	5.0	4.9	4.8	5.1	4.5
Oct. 15.....	6.9	6.1	4.4	4.3	4.5	4.8	4.7	4.6	4.6
Nov. 15.....	6.6	7.1	4.4	4.2	4.4	4.4	4.7	4.4	4.7
Dec. 15.....	6.1	7.1	4.7	4.2	4.3	4.8	4.6	4.4	4.5

TRUCK CROPS.

TABLE 169.—Commercial acreage and production of truck crops in the United States for the years 1917 and 1918.

Crop.	Number of States producing.	Acreage.		Production.		Unit of measure.
		1917	1918	1917	1918	
Asparagus.....	24	31,647	26,459	36,289	28,004	Tons.
Beans (snap).....	33	31,104	31,618	54,156	56,859	Do.
Cabbage.....	16	89,150	101,600	573,220	707,870	Do.
Cantaloupes.....	16	59,559	40,360	7,946,500	6,965,370	Standard crates.
Cauliflower.....	20	9,086	9,972	1,898,974	2,084,148	Crates. ¹
Celery.....	7	14,500	14,750	6,597,750	6,436,500	Do. ²
Corn (sweet).....	28	201,645	241,289	377,688	467,469	Tons.
Cucumbers.....	23	50,521	63,005	42,581	111,711	Do.
Lettuce.....	8	12,500	15,350	6,348,300	7,476,900	Crates. ³
Onions.....	19	62,150	77,489	18,267,325	18,827,938	Bushels.
Peas.....	32	180,407	213,478	152,462	179,102	Tons.
Potatoes (early Irish).....	16	267,850	258,650	18,552,300	27,471,750	Bushels.
Strawberries.....	28	107,000	87,250	7,814,658	6,192,250	Crates. ⁴
Tomatoes.....	39	343,186	320,646	1,811,342	1,701,557	Tons.
Watermelons.....	17	120,700	67,680	44,963,500	24,783,550	Number.
Total.....	1,580,996	1,569,596

¹ Crates of 1 dozen heads each.

² Crates of 10 bunches of 1 dozen plants each.

³ Crates of 2 dozen heads each.

⁴ Crates containing 24 quarts

SUGAR.

TABLE 170.—*Sugar: Production in the United States and its possessions, 1856-57 to 1918-19.*¹

[Data for 1912-13 and subsequently beet sugar, also Louisiana and Hawaii cane sugar, estimated by United States Department of Agriculture; Porto Rico, by Treasury Department of Porto Rico; Philippine Islands, production estimated by the Philippine Department of Agriculture and exports for years ending June 30. For sources of data for earlier years, see Yearbook for 1912, p. 650. A short ton is 2,000 pounds.]

Year.	Beet sugar (chiefly refined).	Cane sugar (chiefly raw).					Total.
		Louisiana.	Other States. ²	Porto Rico.	Hawaii.	Philippine Islands. ³	
Average:	<i>Short tons.</i>	<i>Short tons.</i>	<i>Short tons.</i>	<i>Short tons.</i>	<i>Short tons.</i>	<i>Short tons.</i>	<i>Short tons.</i>
1856-7 to 1860-61.....	-----	132,402	5,978	75,364	-----	46,446	260,190
1861-62 to 1865-66.....	269	74,036	1,945	71,765	-----	54,488	202,503
1866-67 to 1870-71.....	448	44,768	3,818	96,114	-----	81,485	226,633
1871-72 to 1875-76.....	403	67,341	4,113	87,606	(⁴)	119,557	279,020
1876-77 to 1880-81.....	470	104,920	5,327	76,579	27,040	169,067	383,403
1881-82 to 1885-86.....	692	124,868	7,280	87,441	76,075	189,277	485,633
1886-87 to 1890-91.....	1,922	163,049	8,439	70,112	125,440	186,129	555,091
1891-92 to 1895-96.....	19,406	265,655	6,634	63,280	162,538	286,629	807,142
1896-97 to 1900-1901.....	58,287	282,399	4,405	61,292	282,585	134,722	823,690
1901-2 to 1905-6.....	239,730	352,053	12,126	141,478	403,308	108,978	1,257,673
1906-7 to 1910-11.....	479,153	348,544	13,664	282,136	516,041	145,832	1,785,370
1901-2.....	184,606	360,277	4,048	103,152	355,611	75,011	1,082,705
1902-3.....	218,406	368,734	4,169	100,576	437,991	123,108	1,252,984
1903-4.....	240,604	255,894	22,176	138,096	367,475	82,855	1,107,100
1904-5.....	242,113	398,195	16,800	151,088	426,248	125,271	1,359,715
1905-6.....	312,921	377,162	13,440	214,480	429,213	138,645	1,485,861
1906-7.....	483,612	257,600	14,560	206,864	440,017	132,602	1,535,255
1907-8.....	463,628	380,800	13,440	230,095	521,123	167,242	1,776,328
1908-9.....	425,884	397,600	16,800	277,093	535,156	123,876	1,776,409
1909-10.....	512,469	364,000	11,200	346,786	517,090	140,783	1,892,328
1910-11.....	510,172	342,700	12,320	349,840	566,821	164,658	1,946,531
1911-12.....	599,500	352,874	8,000	371,076	595,038	205,046	2,131,534
1912-13.....	692,556	153,573	9,000	398,004	546,524	⁵ 345,077	2,144,734
1913-14.....	733,401	292,698	7,800	351,666	612,000	⁵ 408,339	2,405,901
1914-15.....	722,054	242,700	3,920	346,490	646,000	⁵ 421,192	2,382,356
1915-16.....	874,220	137,500	1,120	483,590	592,763	⁵ 412,274	2,501,467
1916-17.....	820,657	303,900	7,000	503,081	644,663	⁵ 425,266	2,704,567
1917-18.....	765,207	243,600	2,240	462,819	576,700	⁵ 399,033	2,499,599
1918-19.....	740,100	263,450	3,500	-----	-----	-----	-----

¹ Census returns give production of beet sugar for 1899 as 81,729 short tons; for 1904, 253,921; 1909, 501,682; production of cane sugar in Louisiana for 1839, 59,974 short tons; 1849, 226,001 hogsheads; 1859, 221,726 hogsheads; 1869, 80,706 hogsheads; 1879, 171,706 hogsheads; 1889, 146,062 short tons; 1898, 278,497 short tons; 1899, 159,583; and 1909, 325,516 short tons; cane sugar in other States, 1839, 491 short tons; in 1849, 21,576 hogsheads; in 1859, 9,256 hogsheads; in 1869, 6,337 hogsheads; in 1879, 7,166 hogsheads; in 1889, 4,580 short tons; in 1899, 1,691; and in 1909, 8,687 short tons.

² Includes Texas only, subsequent to 1902-3. Unofficial returns.

³ Exports, for years ending June 30.

⁴ Complete data not available for this period. Production in 1878-79, 1,254 short tons; in 1879-80, 1,304 short tons.

⁵ Production.

SUGAR—Continued.

TABLE 171.—*Sugar beets and beet sugar: Production in the United States, 1916–1918.*

[Figures for 1918 are subject to revision.]

State and year.	Area of beets.			Beets produced (weight as delivered to factories).			
	Planted.	Harvested.		Quantity.	Yield per acre.	Farm value.	Price to growers per ton.
		Amount.	Per cent of planted.				
California:	<i>Acres.</i>	<i>Acres.</i>	<i>Per cent.</i>	<i>Short tons.</i>	<i>Short tons.</i>	<i>Dollars.</i>	<i>Dollars.</i>
1918.....	120,900	102,400	84.70	10.33
1917.....	190,200	161,909	85.13	1,331,548	8.22	10,125,000	7.60
1916.....	159,100	141,097	88.68	1,477,426	10.47	9,311,000	6.30
Colorado:							
1918.....	142,000	126,500	88.73	10.00
1917.....	183,600	161,476	87.95	1,857,649	11.50	13,526,000	7.28
1916.....	211,600	188,568	89.12	2,018,298	10.70	12,236,000	6.06
Idaho:							
1918.....	87,700	32,600	86.47	10.00
1917.....	46,500	37,745	81.17	312,067	8.27	2,203,000	7.06
1916.....	48,500	42,135	86.87	357,137	8.48	2,199,000	6.16
Michigan:							
1918.....	134,500	108,200	80.45	10.13
1917.....	112,700	82,151	72.89	524,195	6.38	4,215,000	8.04
1916.....	122,000	99,619	81.65	543,766	5.46	3,337,000	6.14
Nebraska:							
1918.....	44,600	42,800	95.96	9.94
1917.....	55,500	51,337	92.50	473,494	9.22	3,417,000	7.22
1916.....	44,800	41,083	91.70	424,913	10.34	2,622,000	6.17
Ohio:							
1918.....	36,100	33,300	92.24	9.63
1917.....	29,300	24,234	82.71	219,931	9.08	1,580,000	7.18
1916.....	32,600	24,767	75.97	147,718	5.96	1,008,000	6.83
Utah:							
1918.....	90,100	83,600	92.79	10.00
1917.....	91,100	80,289	88.13	762,028	7.49	5,368,000	7.04
1916.....	77,400	68,211	88.13	798,119	11.70	4,577,000	5.73
Wisconsin:							
1918.....	14,900	12,600	84.56	10.00
1917.....	14,100	9,800	69.50	79,372	8.10	699,000	8.81
1916.....	10,500	7,000	66.67	61,500	8.79	373,000	6.06
Other States:							
1918.....	68,900	50,100	72.71	9.73
1917.....	83,600	55,856	66.81	420,093	7.52	3,059,000	7.28
1916.....	62,000	52,828	85.21	399,379	7.56	2,476,000	6.20
United States:							
1918.....	689,700	592,100	85.85	10.02
1917.....	806,600	664,797	82.43	5,980,377	9.00	44,192,000	7.39
1916.....	768,500	665,308	86.57	6,228,256	9.36	38,139,000	6.12

SUGAR—Continued.

TABLE 171.—*Sugar beets and beet sugar: Production in the United States, 1916–1918—Con.*

[Figures for 1918 are subject to revision.]

State and year. ¹	Number of factories.	Average length of campaign.	Sugar made (chiefly refined).	Sugar beets used.			Analysis of beets.		Recovery of sucrose. ⁴		Loss. ⁵
				Area harvested.	Average yield per acre.	Quantity worked.	Percentage of sucrose. ²	Purity coefficient. ³	Percentage of weight of beets.	Percentage of total sucrose in beets.	
		Days.	Short tons.	Acres.	Short tons.	Short tons.	Per ct.	Per ct.	Per ct.	Per ct.	Per ct.
California:											
1918.....	13		109,300	102,400	8.24	843,700			12.96		
1917.....	14	92	209,325	161,909	8.16	1,321,716	18.48	82.91	15.84	85.71	2.64
1916.....	11	108	236,322	141,097	10.37	1,462,895	18.35	84.13	16.15	88.01	2.20
Colorado:											
1918.....	14		182,700	126,500	11.16	1,412,200			12.93		
1917.....	15	91	234,303	161,476	10.84	1,749,875	15.40	85.16	13.39	86.95	2.01
1916.....	14	102	252,147	188,568	10.25	1,933,591	15.00	85.79	13.04	86.93	1.96
Idaho:											
1918.....	8		44,100	32,600	10.34	336,600			13.10		
1917.....	7	70	38,376	37,745	7.59	286,446	16.74	84.84	13.40	80.05	3.34
1916.....	5	86	45,874	42,135	7.87	331,478	16.95	86.39	13.84	81.65	3.11
Michigan:											
1918.....	16		117,600	108,200	8.08	873,700			13.46		
1917.....	14	53	64,247	82,151	5.62	461,721	16.28	86.57	13.91	85.44	2.37
1916.....	15	49	69,341	99,619	5.05	502,705	16.37	85.22	13.79	84.24	2.58
Nebraska:											
1918.....	4		51,300	42,800	10.04	446,100			11.49		
1917.....	4	97	53,893	51,337	9.22	443,355	14.91	80.71	12.16	81.56	2.75
1916.....	3	160	51,945	41,083	10.34	404,017	15.51	81.12	12.86	82.91	2.65
Ohio:											
1918.....	5		43,100	33,300	9.88	328,900			13.09		
1917.....	5	70	24,467	24,234	8.36	202,624	16.24	86.25	12.08	74.38	4.16
1916.....	4	45	18,234	24,767	5.56	137,696	15.89	83.36	13.24	83.32	2.65
Utah:											
1918.....	16		118,000	83,600	12.11	1,012,900			11.65		
1917.....	15	82	83,662	80,289	8.68	696,522	15.61	82.27	12.01	76.94	3.60
1916.....	11	95	90,277	68,211	10.38	708,237	16.05	84.79	12.75	79.44	3.30
Wisconsin:											
1918.....	4		14,300	12,600	8.76	110,400			12.97		
1917.....	4	53	8,032	9,800	7.23	70,830	15.03		11.34	75.45	3.69
1916.....	3	48	6,800	7,000	8.39	58,700	14.90		11.58	77.72	3.32
Other States:											
1918 ⁶	12		59,700	50,100	9.14	458,100			13.03		
1917.....	13	51	48,902	55,856	7.03	392,456	15.17	81.87	12.46	82.14	2.71
1916.....	8	57	49,717	52,828	7.20	380,354	15.69	82.67	13.07	83.30	2.62
United States:											
1918.....	92		740,100	592,100	9.83	5,822,600			12.71		
1917.....	91	74	705,207	664,797	8.46	5,625,545	16.28	83.89	13.60	83.54	2.68
1916.....	74	80	820,657	665,308	8.90	5,919,673	16.30	84.74	13.86	85.03	2.44

¹ Acreage and production of beets are credited, as in former reports, to the State in which the beets were made into sugar.

² Based upon weight of beets.

³ Percentage of sucrose (pure sugar) in the total soluble solids of the beets.

⁴ Percentage of sucrose actually extracted by factories.

⁵ Percentage of sucrose (based upon weight of beets) remaining in molasses and pulp.

⁶ Includes 3 factories in Washington, 3 in Wyoming, and 1 each in Illinois, Indiana, Iowa, Kansas, Minnesota, and Montana.

SUGAR—Continued.

TABLE 172.—Cane-sugar production of Louisiana, 1911–1918.

[Figures for 1918 are from returns made before the end of the season, and are subject to revision.]

Year of cane harvest.	Factories in operation.	Sugar made.	Average sugar made, per ton of cane.	Cane used for sugar.			Molasses made. ¹	
				Area.	Average per acre.	Production.	Total.	Per ton of sugar.
	<i>Number.</i>	<i>Short tons.</i>	<i>Pounds.</i>	<i>Acres.</i>	<i>Short tons.</i>	<i>Short tons.</i>	<i>Gallons.</i>	<i>Gallons.</i>
1911.....	188	352,874	120	310,000	19	5,887,292	35,062,525	99
1912.....	126	153,573	142	197,000	11	2,162,574	14,302,169	93
1913.....	153	292,698	139	248,000	17	4,214,000	24,046,320	82
1914.....	149	242,700	152	213,000	15	3,199,000	17,177,443	74
1915.....	136	137,500	135	183,000	11	2,018,000	12,743,000	93
1916.....	150	303,900	149	221,000	18	4,072,000	26,154,000	86
1917.....	140	243,600	128	244,000	15.6	3,813,000	30,728,000	126
1918.....	263,450	132	3,996,000

¹ Figures for molasses, 1911–1914, are as reported by the Louisiana Sugar Planters' Association; figures for later years as reported by Bureau of Crop Estimates, U. S. Department of Agriculture.

TABLE 173.—Cane-sugar production of Hawaii, 1913–1918.

[Figures for 1918 are subject to revision.]

Island, and year ending Sept. 30.	Factories in operation.	Average length of campaign.	Sugar made.	Cane used for sugar.			Total area in cane.	Average extraction of sugar	
				Area harvested.	Average yield per acre.	Production.		Per cent of cane.	Per short ton of cane.
	<i>Num-ber.</i>	<i>Days.</i>	<i>Short tons.</i>	<i>Acres.</i>	<i>Short tons.</i>	<i>Short tons.</i>	<i>Acres.</i>	<i>Per cent.</i>	<i>Pounds.</i>
Hawaii:									
1918.....	171	162,900	52,700	28	1,498,000	130,800	10.87	217
1917.....	184	232,140	52,700	36	1,898,000	100,300	12.23	245
1916.....	179	197,130	52,627	33	1,713,759	98,787	11.50	230
1915.....	196	240,300	50,800	41	2,099,000	100,200	11.45	229
1914.....	23	174	213,000	51,000	36	1,854,000	11.49	230
1913.....	24	170	197,212	53,600	32	1,703,000	11.58	232
Kauai:									
1918.....	162	137,800	21,400	48	1,037,000	48,600	13.29	265
1917.....	207	119,218	25,400	41	1,040,000	51,300	11.46	229
1916.....	191	108,632	21,392	43	927,970	51,712	11.71	234
1915.....	203	115,700	21,000	45	941,000	49,200	12.30	246
1914.....	9	214	121,000	21,600	50	1,089,000	11.11	222
1913.....	9	198	100,340	20,800	42	841,000	11.93	239
Maui:									
1918.....	231	162,200	23,100	57	1,315,000	50,300	12.33	247
1917.....	180	147,755	23,600	47	1,108,000	49,300	13.33	267
1916.....	168	150,311	19,911	55	1,098,247	51,897	13.69	274
1915.....	174	160,300	19,800	57	1,126,000	44,400	14.24	285
1914.....	7	167	145,000	19,400	54	1,054,000	13.76	275
1913.....	7	152	124,820	19,700	47	929,000	13.44	269
Oahu:									
1918.....	193	113,800	22,600	50	1,005,000	47,100	11.32	227
1917.....	214	145,550	22,200	53	1,174,000	44,200	12.39	248
1916.....	179	136,690	21,489	52	1,119,448	43,936	12.21	244
1915.....	205	129,700	21,600	47	1,019,000	46,000	12.73	255
1914.....	7	188	133,000	20,700	44	903,000	14.73	295
1913.....	10	157	124,152	20,500	49	1,003,000	12.38	248
Territory of Hawaii:									
1918.....	184	576,700	119,800	41	4,855,000	276,800	11.88	238
1917.....	190	644,663	123,900	42	5,220,000	245,100	12.35	247
1916.....	180	592,763	115,419	42	4,859,424	246,332	12.20	244
1915.....	195	646,000	113,200	46	5,185,000	239,800	12.46	249
1914.....	46	183	612,000	112,700	43	4,900,000	12.49	250
1913.....	50	169	546,524	114,600	39	4,476,000	12.21	244

SUGAR—Continued.

TABLE 174.—Sugar: Wholesale price per pound, on New York market, 1913-1918.

Date.	Raw, centrifugal, 96° polarization.			Refined.														
				Cut loaf.			Powdered.			Granulated, fine or standard.			Soft sugar No. 1.			Soft sugar No. 15.		
	Low.	High.	Average.	Low.	High.	Average.	Low.	High.	Average.	Low.	High.	Average.	Low.	High.	Average.	Low.	High.	Average.
1913.	<i>Cts.</i>	<i>Cts.</i>	<i>Cts.</i>	<i>Cts.</i>	<i>Cts.</i>	<i>Cts.</i>	<i>Cts.</i>	<i>Cts.</i>	<i>Cts.</i>	<i>Cts.</i>	<i>Cts.</i>	<i>Cts.</i>	<i>Cts.</i>	<i>Cts.</i>	<i>Cts.</i>	<i>Cts.</i>	<i>Cts.</i>	<i>Cts.</i>
Jan.-June.....	3.25	3.73	5.05	5.70	4.35	5.00	4.25	4.95	4.00	4.65	3.40	4.05
July-Dec.....	3.12	3.80	5.05	5.60	4.25	4.90	4.15	4.85	4.05	4.55	3.45	3.95
1914.																		
Jan.-June.....	2.92	3.48	5.05	5.25	3.95	4.40	3.85	4.35	3.60	4.10	3.00	3.50
July-Dec.....	3.26	6.52	5.25	8.40	4.40	7.60	3.85	7.55	4.10	7.30	3.50	6.70
1915.																		
Jan.-June.....	3.95	5.02	5.85	7.00	5.05	6.20	4.95	6.15	4.70	5.85	4.10	5.25
July-Dec.....	3.50	5.20	5.80	7.05	5.00	6.25	4.90	6.20	4.65	5.90	4.05	5.30
1916.																		
Jan.-June.....	4.33	6.52	6.65	8.80	5.85	7.75	5.75	7.70	5.50	7.50	4.90	6.90
July-Dec.....	4.89	6.65	7.40	8.80	6.35	7.75	6.25	7.70	6.10	7.50	5.50	6.90
1917.																		
January.....	4.75	5.39	7.90	8.00	6.85	6.95	6.75	6.90	6.60	6.70	6.00	6.10
February.....	4.64	5.52	7.90	8.40	6.85	7.35	6.75	7.30	6.60	7.10	6.00	6.50
March.....	5.02	5.96	8.15	8.40	7.10	7.35	7.00	7.30	6.85	7.10	6.25	6.50
April.....	5.77	6.46	8.40	9.00	7.35	7.65	7.25	7.55	7.10	7.35	6.50	6.75
May.....	5.95	6.27	9.00	7.65	7.50	7.55	7.35	6.75
June.....	5.83	6.52	9.00	7.65	7.50	7.55	7.35	6.75
Jan.-June.....	4.64	6.52	7.90	9.00	6.85	7.65	6.75	7.55	6.60	7.35	6.00	6.75
July.....	6.23	7.02	9.00	9.40	7.65	8.05	7.50	7.95	7.35	7.60	6.75	7.15
August.....	7.02	7.77	9.65	9.90	8.30	8.55	8.15	8.45	8.00	8.25	7.40	7.65
September.....	6.90	7.02	9.90	9.90	8.55	8.55	8.40	8.45	8.25	8.25	7.55	7.65
October.....	6.90	6.90	9.85	9.90	8.50	8.55	8.35	8.45	8.20	8.25	7.60	7.65
November.....	6.90	6.90	9.85	9.85	8.50	8.50	8.35	8.40	8.20	8.20	7.60	7.60

December.....	5.92	6.90	9.65	9.85	8.30	8.50	8.15	8.40	8.00	8.20	7.40	7.60	
July-Dec.....	5.92	7.77	9.00	9.90	7.65	8.55	7.50	8.45	7.35	8.25	6.75	7.65	
1918.																			
January.....	6.005	6.005	6.005	8.95	9.65	9.06	7.60	8.30	7.71	7.45	8.20	7.58	7.30	8.00	7.41	6.70	7.40	6.81	
February.....	6.005	6.005	6.005	8.95	8.95	8.95	7.60	7.60	7.60	7.45	7.50	7.48	7.30	7.30	7.30	6.70	6.70	6.70	
March.....	6.005	6.005	6.005	8.95	8.95	8.95	7.60	7.60	7.60	7.45	7.50	7.48	7.30	7.30	7.30	6.70	6.70	6.70	
April.....	6.005	6.005	6.005	8.95	8.95	8.95	7.60	7.60	7.60	7.45	7.50	7.48	7.30	7.30	7.30	6.70	6.70	6.70	
May.....	6.005	6.005	6.005	8.95	8.95	8.95	7.60	7.60	7.60	7.45	7.50	7.48	7.30	7.30	7.30	6.70	6.70	6.70	
June.....	6.005	6.055	6.011	8.95	9.00	8.96	7.60	7.65	7.61	7.45	7.55	7.49	7.30	7.35	7.31	6.70	6.75	6.71	
Jan.-June.....	6.005	6.005	6.046	8.95	9.65	8.97	7.60	8.30	7.62	7.45	8.20	7.50	7.30	8.00	7.32	6.70	7.40	6.72	
July.....	6.005	6.055	6.030	9.00	9.00	9.00	7.65	7.65	7.65	7.50	7.55	7.52	7.35	7.35	7.35	6.75	6.75	6.75	
August.....	6.005	6.055	6.030	9.00	9.00	9.00	7.65	7.65	7.65	7.50	7.55	7.52	7.35	7.35	7.35	6.75	6.75	6.75	
September.....	6.055	7.28	6.980	9.00	10.50	10.19	7.65	9.15	8.84	7.50	9.05	8.34	7.35	8.85	8.54	6.75	8.25	7.94	
October.....	7.28	7.28	7.280	10.50	10.50	10.50	9.15	9.15	9.15	9.00	9.05	9.02	8.85	8.85	8.85	8.25	8.25	8.25	
November.....	7.28	7.28	7.280	10.50	10.50	10.50	9.15	9.15	9.15	9.00	9.05	9.02	8.85	8.85	8.85	8.25	8.25	8.25	
December.....	6.90	7.28	7.256	10.50	10.50	10.50	9.15	9.15	9.15	9.00	9.05	9.02	8.85	8.85	8.85	8.25	8.25	8.25	
July-Dec.....	6.005	7.28	6.809	9.00	10.50	9.95	7.65	9.15	8.60	7.50	9.05	8.41	7.35	8.85	8.30	6.75	8.25	7.70	

SUGAR—Continued.

TABLE 175.—*Sugar: International trade, calendar years 1909–1917.*

[The following kinds and grades have been included under the head of sugar: Brown, white, candied, caramel, *chancaca* (Peru), crystal cube, maple, muscovado, *panela*. The following have been excluded: "Candy" (meaning confectionery), confectionery, glucose, grape sugar, jaggery, molasses, and sirup. See "General note," Table 93.]

EXPORTS.

[000 omitted.]

Country.	Average, 1909–1913.	1916 (prelim.)	1917 (prelim.)	Country.	Average, 1909–1913.	1916 (prelim.)	1917 (prelim.)
<i>From—</i>	<i>Pounds.</i>	<i>Pounds.</i>	<i>Pounds.</i>	<i>From—</i>	<i>Pounds.</i>	<i>Pounds.</i>	<i>Pounds.</i>
Argentina.....	144	891	70	Germany.....	1,746,322		
Austria-Hungary...	1,697,659			Guadeloupe.....	75,270		
Barbados.....	51,657			Martinique.....	85,110		
Belgium.....	308,952			Mauritius.....	452,510		
Brazil.....	76,568	118,663	289,925	Netherlands.....	400,980	101,819	
British Guiana.....	212,393			Peru.....	293,472	526,923	
British India.....	53,222			Philippine Islands.	358,865	744,030	453,946
China.....	29,867	25,555	30,871	Reunion.....	83,316		
Cuba.....	4,019,798			Russia.....	587,028	117,078	
Dominican Republic.	184,703			Trinidad and Tobago.	87,510	129,618	
Dutch East Indies.	2,825,111			United Kingdom...	65,207	10,296	2,450
Egypt.....	16,171	63,533	57,296	Other countries...	660,878		
Fiji.....	157,633	269,983					
France.....	413,795	208,308		Total.....	14,944,141		

IMPORTS.

[000 omitted.]

<i>Into—</i>				<i>Into—</i>			
Argentina.....	103,380	66,930	353,127	Netherlands.....	165,443	17,392	
Australia.....	152,465	181,847		New Zealand.....	125,924	135,115	
British India.....	1,431,980			Norway.....	104,651	136,824	124,377
British South Africa	60,517	7,385	28,064	Persia.....	218,703		
Canada.....	595,785	700,600	794,118	Portugal.....	79,262		
Chile.....	169,931			Singapore.....	163,220		
China.....	687,243	689,472	826,277	Switzerland.....	236,403	243,296	
Denmark.....	43,627			United Kingdom...	3,707,211	2,985,034	2,413,410
Egypt.....	86,041	16,477	24,077	United States ¹ ...	4,245,034	5,532,322	4,944,089
Finland.....	100,153	110,510		Other countries...	1,027,604		
France.....	372,395	1,160,151					
Italy.....	18,499	166,849	123,964	Total.....	14,249,356		
Japan.....	353,885	213,485					

¹ Not including receipts from Hawaii, amounting to an average for five years 1909–1913 of 1,089,659,793, in 1916 to 1,160,018,550, and in 1917 to 1,253,562,475 pounds, and from Porto Rico, to an average for the five years 1909–1913 of 642,628,376, in 1916 to 907,373,407, and in 1917 to 942,439,175 pounds.

SUGAR—Continued.

TABLE 176.—Sugar production of undermentioned countries, campaigns of 1915-16 to 1917-18.

BEET SUGAR (RAW).

Country.	1915-16	1916-17	1917-18	Country.	1915-16	1916-17	1917-18
NORTH AMERICA.				EUROPE—contd.			
United States ¹	<i>Short tons.</i> 874, 220	<i>Short tons.</i> 820, 657	<i>Short tons.</i> 765, 207	Roumania.....	<i>Short tons.</i> 1, 699, 485	<i>Short tons.</i> 1, 600, 000	<i>Short tons.</i> 1, 373, 400
Canada ¹	19, 758			Russia.....			
Total.....	893, 978			Serbia.....			
EUROPE.				Spain.....	117, 334	131, 108	
Austria-Hungary...	1, 212, 530	804, 679	584, 219	Sweden.....	140, 340		
Belgium.....	124, 501			Switzerland.....	2, 646	1, 984	
Denmark.....	143, 299	123, 623	147, 708	Total.....	5, 915, 500		
France ¹	149, 802	204, 405	220, 752	OCEANIA.			
Germany.....	1, 895, 956			Australia.....	627	2, 182	1, 904
Italy.....	165, 781			Grand total..	6, 810, 105		
Netherlands ¹	263, 826	287, 370	220, 434				

CANE SUGAR.

NORTH AMERICA.				EUROPE.			
United States:				Spain.....	4, 700		
Louisiana.....	137, 500	303, 900	243, 600	ASIA.			
Texas ²	1, 120	7, 000	2, 000	British India.....	2, 950, 080	3, 055, 360	3, 616, 480
Hawaii.....	592, 763	644, 663	576, 700	Formosa.....	353, 930	504, 972	518, 089
Porto Rico.....	483, 590	510, 800	² 450, 000	Japan.....			
Virgin Islands.....	16, 534			Java.....	1, 781, 987	1, 797, 811	
Central America:				Philippine Islands.	412, 274	425, 266	399, 033
British Honduras.....				Total.....	5, 498, 271		
Costa Rica.....	5, 740	6, 538		AFRICA.			
Guatemala.....	49, 261			Egypt.....	91, 104	92, 725	
Nicaragua.....	10, 000			Mauritius.....	236, 465	239, 199	249, 887
Mexico ²	71, 650	55, 115	38, 580	Natal.....	² 112, 000	² 114, 000	² 130, 000
West Indies:				Portuguese East Africa.			
British—				Reunion.....			
Antigua.....	9, 397			Total.....	439, 569		
Barbados.....	41, 664	39, 536		OCEANIA.			
Jamaica.....	24, 653			Australia.....	179, 788	336, 000	
St. Christopher-Nevis.....				Fiji.....	95, 831		
St. Lucia ²				Total.....	275, 619		
Trinidad and Tobago.....	71, 939	79, 398	² 56, 769	Total cane sugar.....	11, 885, 446		
Cuba.....	3, 393, 385	3, 421, 597	4, 020, 160	Total beet and cane sugar.....	18, 695, 501		
Dominican Republic ²	140, 443	149, 943	172, 800				
French—							
Guadeloupe ²	39, 256	35, 690	30, 864				
Martinique ²							
Total.....	5, 093, 895						
SOUTH AMERICA.							
Argentina.....	164, 572	92, 669	97, 086				
Brazil.....			² 302, 627				
Guiana:							
British ²	130, 171	113, 848					
Dutch ²							
Paraguay.....	869	813	1, 543				
Peru.....	277, 780	280, 000	280, 000				
Total.....	573, 392						

¹ Refined sugar.

² Unofficial figures.

² Exports.

SUGAR—Continued.

TABLE 177.—Sugar: Total production of countries mentioned in Table 176, 1895-1917 to 1917-18.

Year.	Production.			Year.	Production.		
	Cane. ¹	Beet.	Total.		Cane. ¹	Beet.	Total.
1895-96.....	<i>Short tons.</i> 3,259,000	<i>Short tons.</i> 4,832,000	<i>Short tons.</i> 8,091,000	1907-8.....	<i>Short tons.</i> 7,926,000	<i>Short tons.</i> 7,390,000	<i>Short tons.</i> 15,316,000
1896-97.....	3,171,000	5,549,000	8,720,000	1908-9.....	8,654,000	7,350,000	16,004,000
1897-98.....	3,206,000	5,457,000	8,663,000	1909-10.....	9,423,000	6,991,000	16,414,000
1898-99.....	3,355,000	5,616,000	8,971,000	1910-11.....	9,540,000	9,042,000	18,582,000
1899-1900.....	3,389,000	6,262,000	9,651,000	1911-12.....	10,275,000	7,072,000	17,347,000
1900-1901.....	4,084,000	6,795,000	10,879,000	1912-13.....	10,908,000	9,509,769	20,518,000
1901-2.....	6,818,000	7,743,000	14,561,000	1913-14.....	² 11,270,200	9,433,783	20,703,983
1902-3.....	6,782,000	6,454,000	13,236,000	1914-15.....	³ 11,316,952	8,756,831	20,073,783
1903-4.....	6,909,000	6,835,000	13,744,000	1915-16.....	⁴ 11,885,446	6,810,105	⁴ 18,695,551
1904-5.....	7,662,000	5,525,000	13,187,000	1916-17.....	⁴ 12,306,843	⁴ 3,976,008	⁴ 16,282,851
1905-6.....	7,551,000	8,090,000	15,641,000	1917-18.....	11,186,218	⁴ 3,313,624	14,499,842
1906-7.....	8,365,000	7,587,000	15,952,000				

¹ Prior to 1901-2 these figures include exports instead of production for British India.

² Excluding Costa Rica, Guatemala, and Salvador.

³ Excluding Salvador and St. Lucia.

⁴ Includes only countries for which reports were given in Table 176.

TABLE 178.—Beet and beet sugar production of undermentioned countries.

Country and year.	Factories in operation.	Sugar made, raw.	Beets used for sugar.			Average extraction of sugar.	
			Area harvested.	Average yield per acre.	Quantity worked.	Percentage of weight of beets used.	Per short ton of beets used.
Austria-Hungary:	<i>Number.</i>	<i>Short tons.</i>	<i>Acres.</i>	<i>Short tons.</i>	<i>Short tons.</i>	<i>Per cent.</i>	<i>Pounds.</i>
1910-11.....	214	1,549,102	918,201	11.95	11,038,503	17.5	281
1911-12.....	210	1,180,605	968,771	8.18	8,623,578	16.6	274
1912-13.....	218	2,093,439	1,088,088	13.00	13,911,305	14.8	301
Belgium:			<i>Area cultivated.</i>		<i>Produced.</i>	<i>P. c. of wt. of beets produced.</i>	<i>Per ton of beets produced.</i>
1910-11.....	92	299,035	148,858	13.41	1,996,977	14.97	299
1911-12.....	89	258,780	145,119	11.45	1,660,872	15.58	312
1912-13.....	88	309,308	152,913	12.47	1,907,358	16.22	324
1913-14.....	84	249,395	129,527	11.85	1,534,311	16.25	325
Denmark:							
1910-11.....	8	110,792			817,381	13.56	271
1911-12.....	8	128,032			809,616	15.81	316
1912-13.....	9	148,447	79,986	14.49	1,159,369	12.80	256
1913-14.....	9	179,002			1,025,140	17.46	349
1914-15.....	9	167,803	79,000		910,000		
1915-16.....	9	143,475	77,787		811,351		
1916-17.....	9	123,623	76,020		972,965		
France:		<i>Refined.</i>	<i>Area harvested.</i>		<i>Worked.</i>	<i>P. c. of wt. of beets used.</i>	<i>Per ton of beets used.</i>
1910-11.....	239	717,033	549,969	10.76	6,426,226	11.80	236
1911-12.....	220	512,986	555,575	8.09	4,669,083	11.41	228
1912-13.....	213	967,440	566,539	12.99	7,960,926	13.15	263
1913-14.....	206	790,700	534,230	12.24	6,539,725	12.09	242
1914-15.....	69	333,953	242,781	11.02	2,892,878	11.54	231
1915-16.....	64	149,801	146,305	8.65	1,265,518	11.84	237
Germany:¹		<i>Raw.</i>					
1910-11.....	354	2,770,001	1,180,913	14.72	17,360,003	15.96	319
1911-12.....	342	1,551,797	1,247,213	8.03	9,987,473	15.54	311
1912-13.....	342	2,901,564	1,353,181	13.56	18,344,738	15.82	316
1913-14.....	341	2,885,572	1,316,655	14.19	18,672,939	15.45	309

¹ The production of sugar in Germany, including refined from imported raw sugar, was 2,983,085 short tons in 1912-13 and 2,993,704 in 1913-14.

SUGAR—Continued.

TABLE 178.—Beet and beet sugar production of undermentioned countries—Continued.

Country and year.	Factories in operation.	Sugar made, raw.	Beets used for sugar.			Average extraction of sugar.	
			Area harvested.	Average yield per acre.	Quantity worked.	Percentage of weight of beets used.	Per short ton of beets used.
Italy:	<i>Number.</i>	<i>Refined.</i>	<i>Area cultivated.</i>	<i>Short tons.</i>	<i>Worked.</i>	<i>P. c. of wt. of beets used.</i>	<i>Per ton of beets used.</i>
1910-11.....	35	190,901	124,044	14.92	1,698,551	11.24	225
1911-12.....	37	174,894	131,260	13.30	1,621,760	10.78	216
1912-13.....	37	218,628	133,434	14.40	1,879,328	11.63	233
1913-14.....	37	336,823	152,700	19.70	2,994,816	11.25	225
1914-15.....	30	165,583	100,570	1,422,235
1915-16.....	36	165,781	122,809	1,582,542
Netherlands:							
1910-11.....	27	219,947	138,554	12.94	1,678,803	13.10	262
1911-12.....	27	265,401	137,388	16.06	1,896,187	14.00	280
1912-13.....	27	315,775	160,180	14.99	2,228,851	14.17	283
1913-14.....	27	231,073	149,001	12.27	1,705,878	13.55	271
1914-15.....	27	316,346	156,251	14.06	2,193,577	14.42	288
1915-16 (prelim.)....	23	240,828	139,644	13.52	1,755,964	13.71	274
Russia:		<i>Raw.</i>					
1910-11.....	276	2,074,410	1,631,188	8.9	14,437,305	14.61	292
1911-12.....	281	2,036,990	1,923,539	7.8	14,754,312	13.84	277
1912-13.....	287	1,361,842	1,847,313	6.4	11,538,078	11.73	235
1913-14.....	293	1,680,893	1,756,160	7.7	13,436,058	12.51	250
1914-15.....	265	1,958,975	1,941,122	7.4	13,979,662	14.01	280
1915-16.....	235	1,697,356	1,748,436	7.0	12,324,612	13.77	275
Spain:							
1910-11.....	33	68,743	(¹)		532,882	12.90	258
1911-12.....	32	102,859	90,787		872,834	11.78	236
1912-13.....	33	171,839	105,213		1,302,871	11.33	264
1913-14.....	31	186,680	146,745	(¹)	1,478,114	12.62	252
1914-15.....	(²)	112,231	78,642		813,790	12.08
1915-16.....	27	117,334	99,114		921,013	10.65
Sweden:							
1910-11.....	24	191,713	86,816	13.56	1,218,166	15.53	315
1911-12.....	24	140,409	71,790	14.83	908,372	15.27	309
1912-13.....	24	145,462	66,900	13.95	922,083	15.59	316
United States:		<i>Refined.</i>	<i>Area harvested.</i>				
1910-11.....	61	510,172	398,029	10.17	4,047,292	12.61	252
1911-12.....	66	599,500	473,877	10.68	5,062,333	11.84	237
1912-13.....	73	692,556	555,300	9.41	5,224,377	13.26	265
1913-14.....	71	733,401	580,006	9.76	5,659,462	12.96	259
1914-15.....	60	722,054	483,400	10.9	5,288,500	13.65	273
1915-16.....	67	874,220	611,301	10.1	6,150,293	14.21	267
1916-17.....	74	820,657	665,308	8.90	5,919,673	13.86	277
1917-18.....	91	765,207	664,797	8.46	5,625,545	13.60	272
1918-19 ²	92	740,100	592,100	9.83	5,822,600	12.71	254

¹ No data.

² Preliminary.

SUGAR—Continued.

TABLE 179.—Cane and cane sugar production of undermentioned countries.

Country and year.	Factories in operation.	Sugar made.	Cane used for sugar.			Average extraction of sugar.
			Area harvested.	Average per acre.	Quantity worked.	Per ton of cane used.
						Pounds.
Argentina:	<i>Number.</i>	<i>Short tons.</i>	<i>Acres cultivated.</i>	<i>Short tons.</i>	<i>Short tons.</i>	<i>Pounds.</i>
1910-11.....	(1)	163,701	178,060	(1)	(1)	(1)
1911-12.....	(1)	198,515	230,866	(1)	(1)	(1)
1912-13.....	39	162,313	232,830	(1)	2,338,594	139
1913-14.....	38	304,389	263,656	(1)	3,451,321	176
1914-15.....	37	370,324	269,833	(1)	4,027,967	184
Australia:			<i>Harvested.</i>		<i>Produced.</i>	
1910-11.....	53	253,131	100,237	22.36	2,240,849	226
1911-12.....	53	210,292	101,010	18.65	1,884,120	223
1912-13.....	50	144,776	84,279	15.09	1,271,358	228
Cuba:			<i>Cultivated.</i>			
1910-11.....	171	1,670,151	(2)	(2)	14,736,981	227
1911-12.....	172	2,142,420	(2)	(2)	20,679,593	207
1912-13.....	171	2,737,264	1,340,139	(2)	25,137,684	218
1913-14.....	170	2,891,281	1,334,070	(2)	25,644,949	226
1914-15.....	177	2,967,427			28,068,993	
1915-16.....		3,398,385			26,324,706	
1916-17.....		3,421,897			28,149,841	
Hawaii:			<i>Harvested.</i>			
1911-12.....	(1)	595,038	113,000	42.0	4,774,000	249
1912-13.....	(1)	546,524	114,600	39.0	4,476,000	244
1913-14.....	46	612,000	112,700	45.0	5,094,000	240
1914-15.....	45	646,000	113,200	46.0	5,185,000	249
1915-16.....	(1)	592,763	115,419	42.0	4,859,424	244
Japan:			<i>Cultivated.</i>			
1910-11.....	13	72,454	49,166	18.49	892,662	162
1911-12.....	14	75,797	52,153	18.16	941,550	161
1912-13.....	17	68,867	51,293	17.15	879,624	157
1913-14.....	16	72,613	53,300	17.91	954,758	152
Java (factory plantations):			<i>Harvested.</i>			
1910-11.....	189	1,583,178	321,720	46.43	14,936,035	212
1911-12.....	193	1,424,657	336,021	40.71	13,679,962	208
1912-13.....	191	1,527,584	340,739	45.11	15,370,765	199
Spain:			<i>Cultivated.</i>			
1910-11.....	27	22,371	11,666	21.9	258,138	173
1911-12.....	23	17,831	9,983	16.5	167,092	213
1912-13.....	21	14,585	9,844	15.6	153,707	190
1913-14.....	22	8,131	4,581	17.4	79,719	204
1914-15.....	(1)	6,168	4,717	(1)	70,410	(1)
1915-16.....	16	4,700	2,950	16.59	48,937	194
1916-17.....	16	5,053	4,621		70,286	
United States (Louisiana):			<i>Harvested for sugar.</i>			
1911-12.....	188	352,874	310,000	19.0	5,887,292	120
1912-13.....	126	153,573	197,000	11.0	2,162,574	142
1913-14.....	153	292,698	248,000	17.0	4,214,000	139
1914-15.....	149	242,700	213,000	15.0	3,199,000	152
1915-16.....	136	137,500	183,000	11.0	2,018,000	135
1916-17.....	150	303,900	221,000	18.0	4,072,000	149
1917-18.....	140	243,600	244,000	15.6	3,813,000	128
1918-19.....	128	263,450			2,996,000	132

¹ No data.

SUGAR—Continued.

TABLE 180.—*Sugar beets: Area and production of undermentioned countries, 1915–1917.*

Country.	Area.			Production.		
	1915	1916	1917	1915	1916	1917
NORTH AMERICA.						
United States.....	<i>Acres.</i> 611,000	<i>Acres.</i> 665,308	<i>Acres.</i> 664,797	<i>Short tons.</i> 6,511,000	<i>Short tons.</i> 6,228,000	<i>Short tons.</i> 5,980,377
Canada.....	18,000	15,000	14,000	141,000	71,000	117,600
Total.....	629,000	680,308	678,797	6,652,000	6,299,000	6,097,977
EUROPE.						
Austria-Hungary:						
Austria.....	1,435,000	(²)	(²)	(²)
Hungary.....	266,000	(²)	2,743,000	(²)
Croatia-Slavonia.....	(²)	(²)	(²)	(²)
Bosnia-Herzegovina.....	(²)	(²)	(²)	(²)
Total Austria-Hungary.....	(²)	(²)
Belgium.....	109,000	(²)	(²)	(²)
Bulgaria.....	(²)	(²)	(²)	(²)
Denmark.....	79,000	77,787	76,020	910,000	811,351	972,965
England.....	2,000	151	(²)	(²)
France ³	208,000	188,876	1,663,000	2,105,283
Germany.....	917,000	(²)	(²)	(²)
Italy.....	123,000	123,056	120,091	1,639,000	1,486,231	1,236,781
Netherlands.....	140,000	157,262	1,889,000	2,115,093
Roumania.....	34,000	30,411	204,000	(²)
Russia:						
Russia proper.....	1,871,000	(²)	(²)	(²)
Poland.....	(²)	(²)	(²)	(²)
Northern Caucasia (Kuban).....	11,000	(²)	(²)	(²)
Total Russia, European.....	1,882,000	1,635,000	(²)	(²)
Spain.....	(²)	134,212	(²)	829,912
Sweden.....	79,000	(²)	856,000	(²)
Switzerland.....	2,000	1,977	28,000	22,046
Total.....
Grand total.....

¹ Galicia and Bukowina not included.

² No official statistics.

³ Exclusive of invaded area, in which 115,900 acres were under sugar beets in 1914.

MAPLE SUGAR AND SIRUP.

TABLE 181.—Maple sugar and sirup production, 1909, 1917, and 1918.

[Figures for 1909 are from the United States census; all others are based upon reports from field agents and correspondents of the Bureau of Crop Estimates.]

State and year.	Treestapped.	Sugar made.	Sirup made.	Average per tree.	
				As sugar.	As sirup.
Maine:	<i>Number.</i>	<i>Pounds.</i>	<i>Gallons.</i>	<i>Pounds.</i>	<i>Gallons.</i>
1918.....	290,000	46,400	52,200	1.6	0.20
1917.....	255,000	42,350	48,700	1.7	.21
1909.....	252,764	15,388	43,971	1.45	.18
New Hampshire:					
1918.....	870,000	556,800	147,900	2.0	.25
1917.....	800,000	537,600	142,800	2.1	.26
1909.....	792,147	558,811	111,500	1.83	.23
Vermont:					
1918.....	5,500,000	6,237,000	664,100	2.10	.26
1917.....	5,100,000	5,626,300	552,600	1.97	.25
1909.....	5,585,632	7,726,817	409,953	1.98	.25
Massachusetts:					
1918.....	273,900	182,600	50,800	2.15	.27
1917.....	256,000	182,700	50,800	2.30	.29
1909.....	256,501	156,952	53,091	2.27	.28
Connecticut:					
1918.....	13,500	8,900	3,900	3.0	.38
1917.....	12,000	6,600	2,900	2.5	.31
1909.....	12,296	10,207	4,236	3.65	.46
New York:					
1918.....	6,236,000	3,732,000	1,755,000	2.85	.35
1917.....	5,724,000	2,255,000	1,485,000	2.47	.31
1909.....	4,948,784	3,160,300	993,242	2.24	.28
Pennsylvania:					
1918.....	1,220,000	993,000	440,000	3.7	.46
1917.....	1,130,000	988,800	370,800	3.5	.44
1909.....	1,298,005	1,188,049	391,242	3.33	.42
Maryland:					
1918.....	74,800	179,500	15,000	4.0	.50
1917.....	68,000	161,800	9,500	3.5	.44
1909.....	79,653	351,908	12,172	5.64	.70
West Virginia:					
1918.....	105,000	147,000	27,500	3.5	.44
1917.....	85,000	151,700	18,200	3.5	.44
1909.....	97,274	140,060	31,176	4.0	.50
Ohio:					
1918.....	2,660,000	558,600	1,093,900	3.5	.44
1917.....	2,418,000	536,800	1,051,300	3.7	.46
1909.....	3,170,828	257,592	1,323,431	3.42	.43
Indiana:					
1918.....	700,000	238,000	267,800	3.4	.42
1917.....	637,000	48,000	296,600	3.8	.48
1909.....	742,586	33,419	273,728	2.99	.37
Michigan:					
1918.....	930,000	364,600	279,900	2.80	.35
1917.....	641,400	229,000	175,900	2.55	.32
1909.....	986,737	293,301	269,093	2.48	.31
Wisconsin:					
1918.....	425,000	26,500	107,200	2.08	.26
1917.....	340,000	72,000	81,000	2.12	.26
1909.....	449,727	27,199	124,117	2.26	.28
Total 13 States:					
1918.....	19,298,200	13,270,900	4,905,200	2.72	.35
1917.....	17,466,400	10,838,650	4,286,100	2.58	.32
1909.....	18,672,939	13,920,003	4,040,952	2.48	.31

NOTE.—These 13 States produced, in 1909, 99 per cent of the maple sugar crops of the United States and 98.4 per cent of the maple sirup.

TABLE 182.—Maple sugar and sirup: Farm price, 15th of month, 1913–1918.

Date.	Sugar (cents per pound).						Sirup (dollars per gallon).					
	1918	1917	1916	1915	1914	1913	1918	1917	1916	1915	1914	1913
Feb. 15.....	18.8	14.7	12.6	11.6	12.2	1.58	1.22	1.08	1.06	1.06
Mar. 15.....	20.5	14.7	13.4	12.5	12.4	12.6	1.76	1.30	1.11	1.10	1.10	1.06
Apr. 15.....	22.5	16.3	13.9	12.9	12.5	13.0	1.80	1.33	1.17	1.10	1.10	1.10
May 15.....	22.6	16.2	13.6	12.3	12.3	12.3	1.85	1.34	1.15	1.07	1.10	1.08
June 15.....	22.0	15.9	13.7	12.4	12.2	12.1	1.85	1.33	1.16	1.12	1.12	1.09

SORGHUM FOR SIRUP.

TABLE 183.—Sorghum, for sirup: Acreage, production, and value, by States, 1917 and 1918.

State.	Acreage.		Yield per acre.		Production of sirup (000 omitted).		Average farm price per gallon Dec. 1.		Farm value Dec. 1 (000 omitted).	
	1918	1917	1918	1917	1918	1917	1918	1917	1918	1917
	<i>Acres.</i>	<i>Acres.</i>	<i>Gals.</i>	<i>Gals.</i>	<i>Gallons.</i>	<i>Gallons.</i>	<i>Cts.</i>	<i>Cts.</i>	<i>Dollars.</i>	<i>Dollars.</i>
Virginia.....	10,000	4,000	92	88	920	352	105	88	966	310
West Virginia.....	5,400	4,900	85	94	459	461	120	94	551	433
North Carolina.....	44,000	37,000	95	92	4,180	3,404	99	78	4,138	2,655
South Carolina.....	8,500	8,600	80	86	680	740	97	76	660	562
Georgia.....	14,000	12,000	91	96	1,274	1,152	89	73	1,134	841
Florida.....	200	200	120	142	24	28	87	72	21	20
Ohio.....	6,000	4,000	67	86	402	344	140	103	563	354
Indiana.....	12,000	6,700	75	83	900	556	140	101	1,260	562
Illinois.....	9,660	8,900	80	85	768	756	140	95	1,075	718
Wisconsin.....	2,300	1,800	70	65	161	117	140	105	225	123
Minnesota.....	1,500	1,200	103	87	154	104	145	107	223	111
Iowa.....	4,000	2,500	80	95	320	238	135	97	432	231
Missouri.....	21,600	20,000	70	96	1,512	1,920	115	82	1,739	1,574
Nebraska.....	3,000	200	70	84	210	17	125	90	262	15
Kansas.....	10,000	7,000	47	78	470	546	108	84	508	459
Kentucky.....	33,290	35,000	85	90	2,822	3,150	114	80	3,217	2,520
Tennessee.....	22,500	25,000	92	105	2,070	2,625	88	69	1,822	1,511
Alabama.....	123,200	192,000	77	88	9,486	16,896	75	60	7,114	10,138
Mississippi.....	8,400	10,400	80	108	672	1,123	71	52	477	584
Louisiana.....	600	400	86	120	52	48	90	60	47	29
Texas.....	8,800	8,600	52	70	458	602	95	73	435	439
Oklahoma.....	7,600	7,600	33	85	251	646	94	74	236	478
Arkansas.....	16,000	17,000	60	95	960	1,615	95	66	912	1,066
Utah.....	200	200	96	160	19	32	96	70	18	22
Total.....	372,600	415,200	78.4	90.3	29,224	37,472	95.9	69.5	28,035	26,055

TEA.

TABLE 184.—Tea: International trade, calendar years 1909–1917.

["Tea" includes tea leaves only and excludes dust, sweepings, and yerba mate. See "General note," Table 93.]

EXPORTS.

[000 omitted.]

Country.	Average, 1909–1913.	1916 (prelim.)	1917 (prelim.)	Country.	Average, 1909–1913.	1916 (prelim.)	1917 (prelim.)
<i>From—</i>				<i>From—</i>			
British India.....	<i>Pounds.</i> 267,887	<i>Pounds.</i>	<i>Pounds.</i>	Japan.....	<i>Pounds.</i> 35,823	<i>Pounds.</i> 46,273	<i>Pounds.</i>
Ceylon.....	189,016			Singapore.....	2,575		
China.....	197,997	204,672	149,342	Other countries.....	6,991		
Dutch East Indies.....	46,675			Total.....	770,604		
Formosa.....	23,640	26,110	26,169				

TEA—Continued.

TABLE 184.—Tea: International trade, calendar years 1909–1917—Continued.

IMPORTS.

Country.	Average, 1909– 1913.	1916 (pre- lim.)	1917 (pre- lim.)	Country.	Average, 1909– 1913.	1916 (pre- lim.)	1917 (pre- lim.)
<i>Into—</i>	<i>Pounds.</i>	<i>Pounds.</i>	<i>Pounds.</i>	<i>Into—</i>	<i>Pounds.</i>	<i>Pounds.</i>	<i>Pounds.</i>
Argentina.....	3,890	3,349	Germany.....	8,964
Australia.....	55,442	40,764	Netherlands.....	11,383	18,045
Austria-Hungary.....	3,424	New Zealand.....	7,542	7,982
British India.....	8,002	Persia.....	9,446
British South Africa.....	5,544	6,479	8,734	Russia.....	157,704	172,843
Canada.....	37,927	36,678	52,145	Singapore.....	6,009
Chile.....	3,505	30,944	25,259	United Kingdom.....	293,045	302,416
China.....	18,890	United States.....	98,897	104,767	126,795
Dutch East Indies.....	6,742	Other countries.....	34,294
France.....	2,806	5,830				
French Indo-China.....	3,295	Total.....	756,751

TABLE 185.—Tea: Wholesale price per pound, on New York market, 1913–1918.

Date.	Foochow, fair to fine.			Formosa, fine to choice.			Japan, pan-fired.			India, orange pekoe.			Ceylon, orange pekoe.		
	Low.	High.	Average.	Low.	High.	Average.	Low.	High.	Average.	Low.	High.	Average.	Low.	High.	Average.
1913.	Cts.	Cts.	Cts.	Cts.	Cts.	Cts.	Cts.	Cts.	Cts.	Cts.	Cts.	Cts.	Cts.	Cts.	Cts.
Jan.–June.....	12	22	24	39	13½	35	18½	24	18½	24
July–Dec.....	12	22	24	39	13½	28	18½	21	18½	24
1914.	12	22	24	39	12½	30	18½	21	18½	24
Jan.–June.....	12½	22	23	39	12½	38	18½	27	18½	26
July–Dec.....	12½	22	23	39	12½	38	18½	27	18½	26
1915.	15	22	23	39	18	35	21	30
Jan.–June.....	15	22	23	39	18	35	21	30
July–Dec.....	17	22	23	39	18	40	24	32	24	31
1916.	17½	21	23	39	16	35½	24	30	24	30
Jan.–June.....	17½	21	23	39	16	35½	28	30	28	30
July–Dec.....	17½	21	23	39	16	35	28	30	28	30
1917.	17½	21	23	39	16	35	28	30½	28	30
January.....	17½	21	23	39	16	35	29½	35	29½	35
February.....	17½	21	23	39	16	40	34	42	34	42
March.....	17½	21	23	39	17	40	39	47	39	53
April.....	17½	26	23	39	18	40	46	47	51	53
May.....	17½	26	28	39	22	40	46	47	46	53
June.....	17½	26	25½	60	21	40	42	47	41	43
Jan.–June.....	17½	26	23	60	16	40	28	47	28	53
July.....	22½	27	40	60	21	35	40	43	41	50
August.....	25	27	40	60	23	40	39	45	43	50
September.....	25	27	40	60	24	40	41	45	43	50
October.....	25	27	40	60	24	40	40	45	40	50
November.....	25	27	40	60	24	40	40	45	40	50
December.....	26½	27	40	60	21	40	40	45	40	50
July–Dec.....	22½	27	40	60	21	40	39	45	40	50
1918.	26½	27	26.8	40	60	50.0	24	40	32.0	40	45	42.5	38	50	43.6
January.....	26½	27	26.8	40	60	50.0	24	40	32.0	40	45	42.5	38	45	41.5
February.....	26½	27	26.8	40	60	50.0	24	40	32.0	40	45	42.5	38	45	41.5
March.....	26½	27	26.8	40	60	50.0	24	40	32.0	40	45	42.5	38	45	41.5
April.....	26½	27	26.8	40	60	50.0	24	40	32.0	40	45	42.5	38	45	41.5
May.....	26½	27	26.8	40	60	50.0	24	40	32.0	35	50	44.1	36	45	40.8
June.....	26½	27	26.8	35	60	48.5	25	40	32.5	35	50	42.5	36	45	40.5
Jan.–June.....	26½	27	26.8	35	60	49.8	24	40	32.1	35	50	42.8	36	50	41.6
July.....	26½	30½	29.5	35	60	47.5	25	40	33.9	35	50	42.5	36	45	40.5
August.....	29	30½	29.8	35	60	47.5	28	40	34.0	35	50	42.5	36	45	40.5
September.....	29	30½	29.8	35	60	47.9	28	45	35.9	35	50	42.5	36	45	40.5
October.....	29	30½	29.8	36	60	48.0	28	45	36.5	35	50	42.5	36	45	40.5
November.....	29	30½	29.8	36	60	48.0	28	45	36.5	35	50	42.5	36	45	40.5
December.....	29	30½	29.8	36	60	48.0	28	45	36.5	35	50	42.5	36	45	40.5
July–Dec.....	26½	30½	29.8	35	60	47.8	25	45	35.6	35	50	42.5	36	45	40.5

COFFEE.

TABLE 186.—Coffee: International trade, calendar years 1909–1917.

[The item of coffee comprises unhulled and hulled, roasted, ground, or otherwise prepared, but imitation or "surrogate" coffee and chicory are excluded. See "General note," Table 93.]

EXPORTS.

[000 omitted.]

Country.	Average 1909–1913.	1916 (prelim.)	1917 (prelim.)	Country.	Average 1909–1913.	1916 (prelim.)	1917 (prelim.)
<i>From—</i>				<i>From—</i>			
	<i>Pounds.</i>	<i>Pounds.</i>	<i>Pounds.</i>		<i>Pounds.</i>	<i>Pounds.</i>	<i>Pounds.</i>
Belgium.....	33,626			Netherlands.....	189,288	147,748	
Brazil.....	1,672,282	1,724,741	1,402,787	Nicaragua.....	19,033	23,044	
British India.....	27,730			Salvador.....	62,830	78,829	
Colombia.....	104,398			Singapore.....	4,700		
Costa Rica.....	27,515	37,137		United States ¹	44,251	38,279	50,062
Dutch East Indies.....	54,148			Venezuela.....	111,326		
Guatemala.....	85,951			Other countries.....	52,022		
Haiti.....	61,943						
Jamaica.....	8,263			Total.....	2,608,347		
Mexico.....	48,991						

IMPORTS.

<i>Into—</i>				<i>Into—</i>			
Argentina.....	28,125	32,836		Norway.....	29,309	53,211	32,901
Austria-Hungary...	128,304			Russia.....	26,073	9,801	
Belgium.....	111,738			Singapore.....	6,000		
British South Africa	26,445	28,905	29,944	Spain.....	29,316	36,210	40,185
Cuba.....	24,006			Sweden.....	74,486		
Denmark.....	33,102			Switzerland.....	25,029	43,883	
Egypt.....	15,654	16,640	15,843	United Kingdom...	28,581	29,021	
Finland.....	28,624	15,388		United States.....	907,899	1,166,888	1,286,524
France.....	245,752	337,308		Other countries.....	103,377		
Germany.....	399,965						
Italy.....	58,278	107,948	98,830	Total.....	2,614,596		
Netherlands.....	283,633	196,238					

Chiefly from Porto Rico.

TABLE 187.—Coffee: Wholesale price per pound on the New York and New Orleans markets, 1913-1918.

Date.	New York.															New Orleans.								
	Rio No. 7.			Santos No. 7.			Mocha.			Padang.			Cucuta, washed.			Mexican, Cordoba, washed.			Rio No. 7.			Santos No. 7.		
	Low.	High.	Average.	Low.	High.	Average.	Low.	High.	Average.	Low.	High.	Average.	Low.	High.	Average.	Low.	High.	Average.	Low.	High.	Average.	Low.	High.	Average.
1913.	Cts.	Cts.	Cts.	Cts.	Cts.	Cts.	Cts.	Cts.	Cts.	Cts.	Cts.	Cts.	Cts.	Cts.	Cts.	Cts.	Cts.	Cts.	Cts.	Cts.	Cts.	Cts.	Cts.	Cts.
Jan.-June.....	9½	14	10½	15½	18	21	19	22	12	17½	15	18	9½	14	11½	15
July-Dec.....	8½	11½	10½	13½	18	20	21	23	11½	17½	15	16½	9	11½	10½	12½
1914.																								
Jan.-June.....	8½	9½	10½	11½	17½	21	21	23	14½	18	15½	16½	8½	9½	10½	11½
July-Dec.....	6½	9½	8½	12½	19½	30	21	24	11	18½	12	17½	6½	10½	8½	13½
1915.																								
Jan.-June.....	7	8½	8½	9½	21½	30	21	23½	11½	15½	11	14½	7	8½	8½	9½
July-Dec.....	6½	7½	7½	9	23	30	21	23	11	15½	10½	13½	6½	8	7½	9
1916.																								
Jan.-June.....	7½	9½	7½	9½	19	27	22½	26½	11½	16½	11½	14½	7½	10½	8½	10
July-Dec.....	9	10½	9½	11	18½	20½	25	26½	12	14½	11½	13½	8½	10½	9½	10½
1917.																								
January.....	9½	10	10	10½	18½	20	25	26	12½	14½	12½	13½	10	10½	10½	10½
February.....	9½	10	10	10½	18½	20	25	26	12½	14½	12½	14½	9½	10	9½	10½
March.....	9½	9½	9½	10½	18½	20	24	26	11½	14½	11	13½	9½	9½	9½	10½
April.....	9	10½	9	10½	18½	20	24	26	11½	14	11	12	9½	10½	9½	10½
May.....	10½	10½	10½	10½	18½	22	24	26	11½	14½	11	12	10½	10½	10½	10½
June.....	9½	10½	9½	10	19	22	24	26	11½	14½	11	12	9½	10½	9½	10½
Jan.-June.....	9½	10½	9½	10½	18½	22	24	26	11½	14½	11	14½	9½	10½	9½	10½
July.....	9½	9½	9½	9½	19	22	26	26	11½	14	11	13	9½	9½	9½	10½
August.....	9½	9½	9½	9½	19	22	24	26	11½	14	10½	13	9½	9½	9½	10
September.....	8½	9½	9½	9½	19	22½	24	26	10½	13½	10½	11½	8½	9½	9½	9½
October.....	7½	8½	9	9½	21½	22½	25	26	10½	12½	10½	11½	8½	8½	9½	9½

November.....	7½	8½	8½	9½	21½	22½	25	26	10½	12½	10½	11½	7½	8½	9	9½
December.....	7½	8	8½	9½	21½	22½	25	26	10½	13	10½	11½	7½	8½	9	9½
July-Dec.....	7½	9½	8½	9½	19	22½	24	26	10½	14	10½	13	7½	9½	9	10½
1918.																								
January.....	8	9	8.6	9½	10½	9.9	21½	26½	25.3	25	26	25.5	11	13½	12.5	10½	12½	12.1	8½	9½	8.9	9½	107	10.4
February.....	8	8½	8.1	9½	10½	9.8	25½	26½	26.0	25	26	25.5	12	13½	12.5	11½	12½	12.2	8½	9½	8.8	10½	108	10.3
March.....	8½	9½	9.0	9½	10	9.5	25	26	25.5	12	13	12.7	11½	13½	12.7	9	9½	9.2	10½	11½	10.9
April.....	8½	9½	9.1	10	10½	10.3	25	26	25.5	12½	13	12.8	12½	13½	12.8	9½	9½	9.4	11	11½	11.2
May.....	8½	8½	8.7	9½	10½	7.4	25	26	25.5	12½	13	12.8	12½	13½	12.8	9½	9½	9.1	11	11	11.0
June.....	8½	8½	8.5	9½	10½	10.0	25	26	25.5	12½	13	12.8	12½	13½	12.8	9	9½	9.2	10½	11	11.0
Jan.-June.....	8	9½	8.7	9½	10½	9.5	21½	26½	25.6	25	26	25.5	11	13½	12.7	10½	13½	12.6	8½	9½	9.1	9½	11½	10.8
July.....	8½	8½	8.6	10½	10½	10.4	25	26	25.5	12½	13	12.8	12½	13½	12.8	9	9½	9.0	10½	11½	10.9
August.....	8½	9	8.6	10½	10½	10.4	25	26	25.5	12½	13	12.8	12½	13½	12.8	9	9½	9.1	10½	11½	11.0
September.....	9	10	9.7	10½	12½	11.8	35	37	36.0	25	26	25.5	12½	14	12.9	12½	13½	12.8	9½	10½	10.2	12½	12½	12.8
October.....	9½	10½	10.4	12	14½	13.3	26½	37	33.2	25	27	26.0	13	17	14.9	12½	15½	14.1	10½	11½	11.0	12½	14½	13.7
November.....	10½	13.60	11.0	14½	14½	14.6	27	27½	27.2	26	27	26.5	16	17	16.5	14½	15½	15.2	11½	11½	11.5	14½	14½	14.8
December.....	17½	17½	17.2	20½	21	20.9	30	34	32.0	26	29	27.5	22½	25	23.5	22½	23½	23.0
July-Dec.....	8½	17½	10.9	10½	21	13.6	26½	37	32.1	25	29	26.1	12½	25	15.6	12½	23½	15.1	9	11½	10.2	10½	14½	12.6

OIL CAKE AND OIL-CAKE MEAL.

TABLE 188.—Oil cake and oil-cake meal: International trade, calendar years 1909–1917.

[The class called here "oil cake and oil-cake meal" includes the edible cake and meal remaining after making oil from such products as cotton seed, flaxseed, peanuts, corn, etc. See "General note," Table 93.]

EXPORTS.

[000 omitted.]

Country.	Average, 1909–1913.	1916 (prelim.)	1917 (prelim.)	Country.	Average, 1909–1913.	1916 (prelim.)	1917 (prelim.)
<i>From—</i>				<i>From—</i>			
Argentina.....	<i>Pounds.</i> 42, 587	<i>Pounds.</i> 39, 912	<i>Pounds.</i>	Italy.....	<i>Pounds.</i> 55, 115	<i>Pounds.</i> 32, 453	<i>Pounds.</i> 22, 885
Austria-Hungary...	124, 873	Mexico.....	33, 764
Belgium.....	155, 373	Netherlands.....	219, 819
British India.....	268, 648	Russia.....	1, 453, 413	160, 630
Canada.....	51, 370	31, 707	18, 309	United Kingdom.....	161, 798	3, 857
China.....	147, 468	113, 330	149, 199	United States.....	1, 704, 124	1, 951, 125	735, 053
Denmark.....	15, 777	Other countries.....	83, 814
Egypt.....	161, 624	185, 731	181, 434	Total.....	5, 681, 538
France.....	476, 863	248, 495				
Germany.....	525, 108				

IMPORTS.

<i>Into—</i>				<i>Into—</i>			
Austria-Hungary...	53, 673	Japan.....	189, 868	144, 847
Belgium.....	543, 648	Netherlands.....	707, 116	461, 341
Canada.....	7, 752	14, 730	2, 348	Norway.....	55, 112	74, 964	68, 544
Denmark.....	1, 002, 329	127, 177	Sweden.....	346, 754
Dutch East Indies.....	2, 509	Switzerland.....	69, 352	58, 447
Finland.....	25, 333	United Kingdom.....	790, 865	636, 126
France.....	288, 968	4, 150	Other countries.....	31, 757
Germany.....	1, 686, 416	Total.....	5, 812, 002
Italy.....	10, 550	885	28				

ROSIN.

TABLE 189.—Rosin: International trade, calendar years 1909–1917.

[For rosin, only the resinous substance known as "rosin" in the exports of the United States is taken. See "General note," Table 93.]

EXPORTS.

[000 omitted.]

Country	Average, 1909–1913.	1916 (prelim.)	1917 (prelim.)	Country.	Average, 1909–1913.	1916 (prelim.)	1917 (prelim.)
<i>From—</i>				<i>From—</i>			
Austria-Hungary...	<i>Pounds.</i> 2, 205	<i>Pounds.</i>	<i>Pounds.</i>	Spain.....	<i>Pounds.</i> 20, 073	<i>Pounds.</i> 23, 663	<i>Pounds.</i> 20, 802
Belgium.....	32, 830	United States.....	655, 520	515, 848	417, 664
France.....	118, 286	71, 777	Other countries.....	1, 568
Germany.....	50, 110	Total.....	950, 381
Greece.....	10, 423				
Netherlands.....	59, 366				

ROSIN—Continued.

TABLE 189.—Rosin: International trade, calendar years 1909–1917—Continued.

IMPORTS.

Country.	Average 1909–1913.	1916 (prelim.)	1917 (prelim.)	Country.	Average 1909–1913.	1916 (prelim.)	1917 (prelim.)
<i>Into—</i>	<i>Pounds.</i>	<i>Pounds.</i>	<i>Pounds.</i>	<i>Into—</i>	<i>Pounds.</i>	<i>Pounds.</i>	<i>Pounds.</i>
Argentina.....	32,719	35,998	Italy.....	34,171	43,915	45,482
Australia.....	13,724	10,658	Japan.....	10,073	30,182
Austria-Hungary.....	75,705	Netherlands.....	73,991
Belgium.....	47,163	Norway.....	6,732	11,074	2,054
Brazil.....	36,905	40,714	Roumania.....	5,004
British India.....	6,171	Russia.....	68,429	58,109
Canada.....	25,506	28,882	33,873	Serbia.....	1,162
Chile.....	7,410	Spain.....	1,827	375	198
Cuba.....	4,123	Switzerland.....	4,983	7,852
Denmark.....	3,236	United Kingdom.....	166,075	184,985
Dutch East Indies.....	15,039	Other countries.....	18,734
Finland.....	6,027	9,630	Total.....	990,441
France.....	2,432	707				
Germany.....	233,100				

TURPENTINE.

TABLE 190.—Turpentine (spirits): International trade, calendar years 1909–1917.

["Spirits of turpentine" includes only "spirits" or "oil" of turpentine and, for Russia, *skipidar*; it excludes crude turpentine, pitch, and, for Russia, *terpentin*. See "General note," Table 93.]

EXPORTS.

[000 omitted.]

Country.	Average 1909– 1913.	1916 (pre- lim.)	1917 (pre- lim.)	Country.	Average 1909– 1913.	1916 (pre- lim.)	1917 (pre- lim.)
<i>From—</i>	<i>Gallons.</i>	<i>Gallons.</i>	<i>Gallons.</i>	<i>From—</i>	<i>Gallons.</i>	<i>Gallons.</i>	<i>Gallons.</i>
Belgium.....	1,144	Spain.....	1,156	1,144	1,260
France.....	2,594	991	United States.....	17,868	9,544	6,529
Germany.....	460	Other countries.....	649
Netherlands.....	2,750	4	Total.....	28,943
Russia.....	2,322	5				

IMPORTS.

<i>Into—</i>				<i>Into—</i>			
Argentina.....	554	500	New Zealand.....	178	158
Australia.....	564	677	Russia.....	273	160
Austria-Hungary.....	2,581	Sweden.....	134
Belgium.....	1,932	Switzerland.....	466
Canada.....	1,175	1,135	1,039	United Kingdom.....	7,782	5,937
Chile.....	198	Other countries.....	1,057
Germany.....	9,368	Total.....	31,200
Italy.....	940	754	702				
Netherlands.....	3,998	6				

INDIA RUBBER.

TABLE 191.—India rubber: International trade, calendar years 1909–1917.

[Figures for india rubber include "india rubber," so called, and *caoutchouc*, *caucho*, *jébe* (Peru), *hule* (Mexico), *borracha*, *massaranduba*, *mangabeira*, *manicoba*, *sorva*, and *seringa* (Brazil), *gomelastick* (Dutch East Indies), *caura*, *ser nambi* (Venezuela). See "General note," Table 93.]

EXPORTS.

[000 omitted.]

Country.	Average, 1909– 1913.	1916 (pre- lim.)	1917 (pre- lim.)	Country.	Average, 1909– 1913.	1916 (pre- lim.)	1917 (pre- lim.)
<i>From—</i>	<i>Pounds.</i>	<i>Pounds.</i>	<i>Pounds.</i>	<i>From—</i>	<i>Pounds.</i>	<i>Pounds.</i>	<i>Pounds.</i>
Angola.....	5,620			Kameran.....	6,409		
Belgium Kongo.....	7,755			Mexico.....	14,262		
Belgium.....	20,749			Netherlands.....	7,172		
Bolivia.....	8,395			Peru.....	5,030	6,197	
Brazil.....	84,938	69,433	74,912	Senegal.....	1,087		
Ceylon.....	10,953			Singapore.....	5,843		
Dutch East Indies.....	7,679			Nigeria.....	3,054		
Ecuador.....	1,040	837		Negri Sembilan.....	3,995		
France.....	21,615	6,357		Perak.....	7,313		
French Guiana.....	3,937			Selangor.....	13,736		
French Kongo.....	3,797			Venezuela.....	772		
Germany.....	9,844			Other countries.....	28,936		
Gold Coast.....	2,393						
Ivory coast.....	2,740			Total.....	289,064		

IMPORTS.

<i>Into—</i>				<i>Into—</i>			
Austria-Hungary.....	6,696			Russia.....	19,131	17,804	
Belgium.....	25,891			United Kingdom.....	43,141	59,941	
Canada.....	3,945	986,797	13,641	United States.....	100,180	270,090	405,638
France.....	32,704	39,122		Other countries.....	12,424		
Germany.....	42,004			Total.....	302,319		
Italy.....	5,381	11,728	13,508				
Netherlands.....	10,822						

SILK.

TABLE 192.—Production of raw silk in undermentioned countries, 1913–1917.

[Estimates of the Silk Merchants' Union of Lyons, France.]

Country.	1913	1914	1915	1916	1917
Western Europe:	<i>Pounds.</i>	<i>Pounds.</i>	<i>Pounds.</i>	<i>Pounds.</i>	<i>Pounds.</i>
Italy.....	7,804,000	8,950,000	6,349,000	7,963,000	6,217,034
France.....	772,000	893,000	287,000	485,000	451,948
Spain.....	181,000	161,000	121,000	198,000	154,323
Austria.....	331,000	388,000	187,000	187,000	187,393
Hungary.....	271,000	278,000	143,000	143,000	143,300
Total.....	9,359,000	10,670,000	7,087,000	8,976,000	7,153,998
Levant and Central Asia:					
Broussa and Anatolia.....	1,025,000	761,000	386,000	386,000	
Syria and Cyprus.....	1,080,000	948,000	772,000	772,000	
Other Provinces of Asiatic Turkey.....	298,000	242,000	143,000	143,000	
Turkey in Europe ¹	187,000	132,000	66,000	66,000	
Saloniki and Adrianople.....					
Balkan States (Bulgaria, Serbia, and Roumania).....	298,000	386,000	220,000	220,000	
Greece, Saloniki, ¹ and Crete.....	408,000	309,000	243,000	243,000	
Caucasus.....	849,000	794,000	276,000	276,000	
Persia (exports).....	463,000	176,000	77,000	77,000	
Turkestan (exports).....	496,000	187,000	110,000	110,000	
Total.....	5,104,000	3,935,000	2,293,000	2,293,000	2,292,507
Far East:					
China—					
Exports from Shanghai.....	12,709,000	9,116,000	12,037,000	10,340,000	10,251,492
Exports from Canton.....	6,063,000	4,233,000	4,068,000	5,346,000	5,081,654
Japan—					
Exports from Yokohama.....	26,720,000	20,922,000	26,466,000	29,431,000	34,061,410
British India—					
Exports from Bengal and Cashmere.....	249,000	75,000	192,000	254,000	231,485
Indo-China—					
Exports from Saigon, Halphong, etc.....	26,000	35,000	29,000	7,000	11,023
Total.....	45,767,000	34,381,000	42,792,000	45,378,000	49,637,064
Grand total.....	60,230,000	48,986,000	52,172,000	56,647,000	59,083,869

¹ Prior to 1913 Turkey in Europe included the Vilayet of Saloniki, which now belongs to Greece.

TABLE 193.—Total production of raw silk in countries mentioned in Table 192, 1900–1917.

Year.	Production.	Year.	Production.	Year.	Production.
	<i>Pounds.</i>		<i>Pounds.</i>		<i>Pounds.</i>
1900.....	40,724,000	1906.....	46,106,000	1912.....	59,447,000
1901.....	42,393,000	1907.....	48,634,000	1913.....	60,230,000
1902.....	41,368,000	1908.....	53,087,000	1914.....	48,986,000
1903.....	39,981,000	1909.....	54,035,000	1915.....	52,172,000
1904.....	45,195,000	1910.....	54,002,000	1916.....	56,647,000
1905.....	41,513,000	1911.....	54,167,000	1917 (preliminary).....	59,083,869

WOOD PULP.

TABLE 194.—Wood pulp: International trade, calendar years 1909–1917.

[All kinds of pulp from wood have been taken for this item, but no pulp made from other fibrous substances. See "General note," Table 93.]

EXPORTS.

[000 omitted.]

Country.	Average, 1909–1913.	1916 (prelim.)	1917 (prelim.)	Country.	Average, 1909–1913.	1916 (prelim.)	1917 (prelim.)
From—	<i>Pounds.</i>	<i>Pounds.</i>	<i>Pounds.</i>	From—	<i>Pounds.</i>	<i>Pounds.</i>	<i>Pounds.</i>
Austria-Hungary...	205,364	223,139	Sweden.....	1,822,023
Belgium.....	80,647	Switzerland.....	13,072	14,671
Canada.....	606,203	1,117,796	1,023,607	United States.....	24,309	80,046	77,717
Finland.....	236,881	222,139	Other countries.....	75,486
Germany.....	384,709	Total.....	4,938,507
Norway.....	1,437,078	1,522,991	891,897				
Russia.....	52,735				

IMPORTS.

Into—				Into—			
Argentina.....	52,016	49,128	Russia.....	56,072	234,553
Austria-Hungary...	13,366	Spain.....	92,770	151,124	73,712
Belgium.....	291,254	Sweden.....	9,515
Denmark.....	110,866	Switzerland.....	21,059	25,704
France.....	836,899	798,674	United Kingdom....	1,891,006	1,474,054
Germany.....	112,660	United States.....	1,007,239	1,367,529	1,355,480
Italy.....	179,267	144,333	43,320	Other countries....	85,052
Japan.....	79,260	128,271	Total.....	4,856,963
Portugal.....	18,662				

LIVE STOCK, 1918.

FARM ANIMALS AND THEIR PRODUCTS.

TABLE 195.—Live stock in principal and other countries.

[Latest census or other official figures available, with comparison for earlier years. Census returns are in italics; other official figures are in roman type.]

PRINCIPAL COUNTRIES.

Country.	Date.	Cattle.	Buffaloes.	Swine.	Sheep.	Goats.	Horses.	Mules.	Asses.
		<i>Thousand.</i>	<i>Thousand.</i>	<i>Thousand.</i>	<i>Thousand.</i>	<i>Thousand.</i>	<i>Thousand.</i>	<i>Thousand.</i>	<i>Thousand.</i>
United States:									
On farms.....	Jan. 1, 1919	67,866		75,587	49,863	(1)	21,534	4,925	(1)
	Jan. 1, 1918	67,422		70,978	48,603	(1)	21,555	4,873	(1)
	Jan. 1, 1917	63,617		67,453	48,483	(1)	21,126	4,639	(1)
	Jan. 1, 1916	61,920		67,766	48,625	(1)	21,159	4,593	(1)
	Jan. 1, 1915	58,329		64,618	49,956	(1)	21,195	4,479	(1)
	Apr. 15, 1910	61,804		68,186	52,448	2,915	19,833	4,210	106
Not on farms.....	do.....	1,879		1,288	391	115	3,183	270	17
Alaska (on farms and not on farms).....	Jan. 1, 1910	1	2 22	(*)	(*)	(*)	2	(*)	(*)
Hawaii (on farms and not on farms).....	Apr. 15, 1910	149		31	77	5	28	9	3
Porto Rico (on farms and not on farms).....	do.....	316		106	6	49	58	5	1
Virgin Islands:									
On farms.....	Nov. 1, 1917	12		2	1	2	2	2	1
Not on farms.....	do.....	(*)		(*)	(*)	1	(*)	(*)	(*)
Algeria.....	Dec. 31, 1912	1,107		114	8,338	3,772	221	192	271
	Sept., 1910	1,128		109	9,042	3,990	230	192	276
	Sept., 1905	1,067		91	9,063	4,030	221	174	278
	Sept., 1900	993		82	6,724	3,563	202	147	263
	Sept., 1895	1,121		84	7,892	3,545	217	142	287
Argentina.....	June 1, 1914	25,867		2,901	43,225	4,325	8,324	565	260
	May 1, 1908	29,124		1,404	67,384	5,947	7,538	465	285
	May, 1895	21,702		655	74,380	2,749	4,447	285	198
	1888	21,962		394	66,706	1,894	4,234		
Australia.....	Dec. 31, 1916	10,459		1,007	76,669		2,441		417
	Dec. 31, 1915	9,924		760	69,706	4 262	2,395		4 8
	Dec. 31, 1914	11,051		862	78,600		2,521	(1)	(1)
	Dec. 31, 1910	11,745		1,026	92,047	314	2,166		5
	Dec. 31, 1905	8,528		1,015	74,541	(1)	1,675	(1)	(1)
	Dec. 31, 1900	8,640		950	70,603	(1)	1,610	(1)	(1)
	Dec. 31, 1895	11,767		823	90,690	(1)	1,680	(1)	(1)
	1890	10,300		891	97,881	(1)	1,522	(1)	(1)
Austria-Hungary:									
Austria.....	Dec. 31, 1910	9,159	1	6,432	2,428	1,257	1,803	21	53
	Dec. 31, 1900	9,511	(1)	4,683	2,621	1,020	1,716	20	46
	Dec. 31, 1890	8,644	(1)	3,550	3,187	1,036	1,548	17	41
	Dec. 31, 1880	8,584	(1)	2,722	3,841	1,007	1,463		50
Hungary.....	Apr., 1913	6,045	162	6,825	6,560	269	2,005	1	16
	Feb. 28, 1911	6,184		6,416	7,698	531	2,001	1	18
	Nov. 20, 1895	5,830		6,447	7,527	237	1,997		22
	1884	4,879		4,804	10,595	270	1,749		23
Croatia-Slavonia..	Mar. 24, 1911	1,135		1,164	850	96	350		5
	Dec. 31, 1895	909		883	596	22	311	1	2
Bosnia - Herzegovina.	Oct. 10, 1910	1,309	1	527	2,499	1,393	222	(*)	6
	Nov. 10, 1910								
	Apr. 22, 1895	1,416	1	662	3,231	1,447	251	1	5
	May 22, 1895								
Belgium.....	Dec. 31, 1913	1,849		1,412	(1)	(1)	267	(1)	
	Dec. 31, 1910	1,880		1,494	185	218	317		11
	Dec. 31, 1895	1,421		1,163	236	241	272		7
	Dec. 31, 1880	1,383		646	365	(1)	272	(1)	(1)
Brazil.....	1916	28,962		17,329	7,205	6,920	6,965	3,222	
	1912-13	30,705		18,399	10,653	10,049	7,289	3,208	
Bulgaria.....	Dec. 31, 1910	1,603	415	527	8,632	1,459	478	12	117
	Dec. 31, 1905	1,696	477	465	8,131	1,384	538	12	128
	Dec. 31, 1900	1,596	431	368	7,015	1,405	495	9	104
	Dec. 31, 1892	1,426	342	462	6,868	1,264	344	8	82

¹ No official statistics.

² Reindeer.

³ Less than 500.

⁴ Dec. 31, 1913.

TABLE 195.—Live stock in principal and other countries—Continued.

PRINCIPAL COUNTRIES—Continued.

Country.	Date.	Cattle.	Buffaloes.	Swine.	Sheep.	Goats.	Horses.	Mules.	Asses.
		<i>Thousand.</i>	<i>Thousand.</i>	<i>Thousand.</i>	<i>Thousand.</i>	<i>Thousand.</i>	<i>Thousand.</i>	<i>Thousand.</i>	<i>Thousand.</i>
Canada.....	June 30, 1918	10,051		4,290	3,053	(1)	3,609	(1)	(1)
	June 30, 1917	7,920		3,619	2,369	(1)	3,413	(1)	(1)
	June 30, 1916	6,594		3,475	2,023	(1)	3,258	(1)	(1)
	June 30, 1915	6,066		3,112	2,039	(1)	2,996	(1)	(1)
	June 1, 1911	6,533		3,610	2,175	(1)	2,596	(1)	(1)
	June 30, 1901	5,576		2,354	2,510	(1)	1,577	(1)	(1)
	1891	4,121		1,734	2,564	(1)	1,471	(1)	(1)
	1881	3,515		1,208	3,049	(1)	1,059	(1)	(1)
Denmark.....	Feb. 20, 1918	2,142		513	247	(1)	511	(1)	(1)
	Feb. 1, 1917	2,453		1,981	270	(1)	538	(1)	(1)
	Feb. 29, 1916	2,290		1,983	255	(1)	515	(1)	(1)
	May 15, 1915	2,417		1,919	533	(1)	526	(1)	(1)
	July 15, 1914	2,463		2,497	515	41	567	(1)	(1)
	July 15, 1909	2,254		1,468	727	40	535	(1)	(1)
	July 15, 1903	1,840		1,457	877	59	487	(1)	(1)
	July 15, 1898	1,745		1,168	1,074	52	449	(1)	(1)
Finland.....	1910	1,573	2 120	418	1,309	13	361	(1)	(1)
	1905	1,481	2 142	220	938	6	324	(1)	(1)
	1900	1,428	2 119	211	985	8	311	(1)	(1)
	1890	1,305	2 86	194	1,054	15	293	(1)	(1)
France.....	3 July 1, 1917	12,443		4,200	10,587		2,283	150	325
	3 Dec. 31, 1916	12,342		4,362	10,845	1,177	2,246	148	327
	3 Dec. 31, 1915	12,514		4,916	12,379	1,230	2,156	144	324
	3 Dec. 31, 1914	12,668		5,926	14,038	1,317	2,105	152	337
	Dec. 31, 1913	14,807		7,048	16,213	1,453	3,231	193	360
	Dec. 31, 1910	14,533		6,900	17,111	1,418	3,198	193	361
	Dec. 31, 1900	14,521		6,740	20,180	1,558	2,903	205	356
	Nov. 30, 1892	13,709		7,421	21,116	1,845	2,795	217	509
	1882	12,997		7,147	23,809	1,651	2,838	251	296
	1862	12,812		6,038	29,530	1,726	2,914	(1)	(1)
Germany.....	Dec. 1, 1915	20,317		17,287	5,073	3,438	3,542	(1)	(1)
	Dec. 1, 1914	21,889		25,341	5,471	3,538	3,435	(1)	(1)
	Dec. 1, 1913	20,994		25,659	5,521	3,548	3,227	(1)	(1)
	Dec. 2, 1912	20,182		21,924	5,803	3,410	4,523	15	(1)
	Dec. 2, 1907	20,631		22,147	7,704	3,534	4,345	11	(1)
	Dec. 1, 1904	19,332		18,921	7,907	3,330	4,267	(1)	(1)
	Dec. 1, 1900	18,940		16,807	9,693	3,267	4,195	8	(1)
	Dec. 1, 1897	18,491		14,275	10,867	(1)	4,038	(1)	(1)
	Dec. 1, 1892	17,556		12,174	13,590	3,092	3,836	7	(1)
	Jan. 10, 1883	15,787		9,206	19,190	3,641	3,523	10	(1)
	1914	300	(1)	227	3,547	2,638	149	80	133
Greece.....									
India:									
British.....	1915-16								
	1914-15	128,310	19,025	(1)	23,016	33,338	1,653	71	1,512
	1913-14	125,042	18,235	(1)	23,092	30,673	1,643	86	1,501
	1910-11	94,664	16,628	(1)	22,922	28,518	1,524	110	1,342
	1904-5	77,111	12,871	(1)	17,562	24,803	1,278	54	1,177
	1899-1900	72,666	12,120	(1)	17,805	19,005	1,308		1,227
	1894-95	67,045	11,826	(1)	17,260	15,272	1,134		1,102
Native States.....	1913-14	12,236	1,765	(1)	8,306		175		181
	1909-10	10,391	1,559	(1)	7,129		141		155
	1904-5	8,178	1,347	(1)	6,318		92		129
	1900-1	7,397	1,228	(1)	4,538		85		115
Italy.....	1914	6,646		2,722	13,824			2,235	
	Mar. 10, 1908	6,199	19	2,508	11,163	2,715	956	388	850
	Feb. 15, 1881	4,772	11	1,164	8,596	2,016	658	294	674
Japanese Empire:									
Japan.....	Dec. 31, 1916	1,343	(1)	328	3	109	1,572	(1)	(1)
	Dec. 31, 1915	1,388	(1)	333	3	97	1,580	(1)	(1)
	Dec. 31, 1914	1,387	(1)	332	3	95	1,579	(1)	(1)
	Dec. 31, 1913	1,389	(1)	310	3	89	1,582	(1)	(1)
	Dec. 31, 1910	1,384	(1)	279	3	92	1,565	(1)	(1)
	Dec. 31, 1905	1,168	(1)	228	4	72	1,368	(1)	(1)
	Dec. 31, 1900	1,261	(1)	181	2	60	1,542	(1)	(1)
Chosen (Korea)...	Dec. 31, 1915	1,354	(1)	767		14	55		13
	Dec. 31, 1914	1,338	(1)	758		12	53		14
	Dec. 31, 1913	1,211	(1)	761		10	51		13
	Dec. 31, 1910	704	(1)	566		7	40	(1)	(1)
Formosa (Taiwan).	Dec. 31, 1916	2	385	1,295	(7)	118	(7)		
	Dec. 31, 1915	2	397	1,319	(7)	117	(7)		
	Dec. 31, 1914	2	398	1,313	(7)	125	(7)		
	Dec. 31, 1905	(8)	341	1,018	(7)	108	(7)		
Mexico.....	June 30, 1902	5,142		616	3,424	4,206	859	334	288

1 No official statistics.

2 Reindeer.

3 Excludes invaded area.

4 Including Army horses.

5 Including young buffaloes.

6 Not including young buffaloes.

7 Less than 500.

TABLE 195.—Live stock in principal and other countries—Continued.

PRINCIPAL COUNTRIES—Continued:

Country.	Date.	Cattle.	Buffaloes.	Swine.	Sheep.	Goats.	Horses.	Mules.	Asses.
		Thousand.	Thousand.	Thousand.	Thousand.	Thousand.	Thousand.	Thousand.	Thousand.
Netherlands.....	Apr. 11, 1917	2,304		1,185	521		(1)	(1)	(1)
	May, 1915	2,390		1,487	(1)	(1)	(1)	(1)	(1)
	June, 1913	2,097		1,350	842	232	334	(1)	(1)
	May 20, 1910	2,027		1,260	889	224	227	(1)	(1)
	June 20, 1910								
	Dec. 31, 1904	1,691		862	697	166	295	(1)	(1)
	Dec. 31, 1900	1,656		747	771	180	295	(1)	(1)
	Dec. 31, 1890	1,533		579	819	165	273	(1)	(1)
	Jan. 31, 1918	2,888		258	26,538				
	Jan. 31, 1917	2,503		278	24,753				
New Zealand.....	Jan. 31, 1916	2,417		298	24,788	17	371	(2)	(2)
	Apr. 1, 1911	2,020		349		6	404	(2)	(2)
	Apr. 30, 1911				25,996				
	Apr. 30, 1905				19,131				
	Oct., 1905	1,811		250			327	(2)	(2)
	Apr. 30, 1900			251		(1)	266	(2)	(2)
	Oct., 1900	1,257			19,827	(1)			
	Apr., 1895					(1)			
	1895	1,048		240			237	(2)	(2)
	1891	832		309	18,128	9	211	(2)	(2)
Norway.....	Sept. 30, 1916	1,119	(1)	221	1,281	230	189	(1)	(1)
	Sept. 30, 1915	1,121	(1)	209	1,330	240	186	(1)	(1)
	Sept. 30, 1914	1,146	(1)	228	1,327	237	182	(1)	(1)
	Sept. 30, 1910	1,134	(1)	334	1,398	288	168	(1)	(1)
	Sept. 30, 1909	1,089	3 143	307	1,391	296	164	(1)	(1)
	1900	950	3 109	165	999	215	173	(1)	(1)
	1890	1,006	3 170	121	1,418	272	151	(1)	(1)
Paraguay.....	1915	5,249		61	600	87	478		
	1902	2,461		37	222	50	218	9	2
	1889	2,283		24	214	32	183	3	5
	1886	730		12	32	11	62	2	4
	1877	201		3	7		21	1	2
	1916								
Philippine Islands.....	Dec. 31, 1915	534	1,222	2,521	129	644	223	(1)	(1)
	Dec. 31, 1910	270	757	1,682	94	441	143	(1)	(1)
	Dec. 31, 1902	128	641	1,179	30	124	144	(1)	(1)
	Oct., 1906	703	(1)	1,111	3,073	1,034	88	58	144
Portugal.....	1870	625	(1)	971	2,977	937	87	51	138
	1916	2,938		1,382	7,811	301	1,219	(2)	12
	1911	2,667		1,021	5,269	187	825		4
Roumania.....	1907	2,585		1,124	5,105	194	808		5
	Dec., 1900	2,545	44	1,709	5,655	233	364	1	7
	1890	2,520		926	5,002	210	595		6
	1884	2,376		886	4,655	245	533		2
	1914	32,704	(1)	11,581	37,240	(1)	22,529	(1)	(1)
Russian Empire: Russia, European	1913	31,974	3 605	13,458	41,426	873	22,771	6	7
	1910	31,315	3 462	12,049	40,734	857	21,868	5	2
	1900	31,661	3 350	11,761	47,628	1,017	19,744	1	2
	1890	25,528	(1)	9,554	46,052	(1)	19,779	(2)	(2)
	1881	22,122	(1)	9,265	45,522	1,157	15,534	(2)	(2)
	1914	2,014	(1)	452	565		1,098		
	1913	2,011	(2)	491	683	9	1,116	(2)	(2)
	1910	2,301	(2)	612	1,050	9	1,222	(2)	(2)
	In summer, 1900	2,823	(2)	1,402	2,823	11	1,392		1
	1890	3,013	(2)	1,499	3,755	(1)	1,207	(2)	
1881	5,055	(2)	706	3,375	10	1,037			
Russia, Asiatic (33 governments of the Caucasus, Central Asia, and Siberia).....	1914	17,334	(1)	2,962	34,468	(1)	11,346	(1)	(1)
	1913	18,404	(1)	2,895	38,696	4,791	11,959	(1)	(1)
	Dec. 31, 1910	967	7	866	3,819	631	153	1	1
Serbia.....	Dec. 31, 1905	963	7	908	3,160	510	174	1	1
	1916	3,071		2,814	16,012	3,207	489	913	830
Spain.....	1914	2,743		2,810	16,128	3,205	525	984	841
	1913	2,879		2,710	16,441	3,394	542	948	849
	Dec. 31, 1910	2,369		2,424	15,117	3,216	520	886	868
	Dec. 31, 1906	2,497		2,080	13,481	2,440	440	802	744
	1891	2,218		1,928	13,359	2,534	397	768	754

1 No official statistics.

2 Less than 500.

3 Reindeer.

TABLE 195.—Live stock in principal and other countries—Continued.

PRINCIPAL COUNTRIES—Continued.

Country.	Date.	Cattle.	Buffaloes.	Swine.	Sheep.	Goats.	Horses.	Mules.	Asses.
		<i>Thousand.</i>	<i>Thousand.</i>	<i>Thousand.</i>	<i>Thousand.</i>	<i>Thousand.</i>	<i>Thousand.</i>	<i>Thousand.</i>	<i>Thousand.</i>
Sweden.....	June 1, 1917	3,020		1,030	1,344	136	715		
	June 1, 1916	2,913		1,065	1,198	132	701	(1)	(1)
	Dec. 31, 1914	2,761		1,015	993	77	603	(1)	(1)
	Dec. 31, 1913	2,721		968	988	71	596	(1)	(1)
	Dec. 31, 1910	2,748	2 273	957	1,004	69	587	(1)	(1)
	Dec. 31, 1905	2,550	2 226	830	1,074	67	555	(1)	(1)
	1900	2,583	2 232	806	1,261	80	533	(1)	(1)
Switzerland.....	1890	2,399	2 288	645	1,351	87	487	(1)	(1)
	Apr. 19, 1918	1,530		364	225	355	129	3	1
	Apr. 19, 1916	1,616		544	172	358	137	3	1
	Apr. 21, 1911	1,443		570	161	341	144	3	2
	Apr. 20, 1906	1,498		549	210	362	135	3	2
Apr. 19, 1901	1,340		555	219	355	125	3	2	
Turkey, European and Asiatic.....	1913	2,398	164	31	(1)	(1)	(1)	(1)	(1)
	1912	(1)	(1)	73	27,095	20,269	(1)	(1)	(1)
	1910	(1)	(1)	175	27,662	21,283	(1)	(1)	(1)
	1905	(1)	(1)	196	23,614	16,411	(1)	(1)	(1)
Union of South Africa.	Dec. 31, 1915	(1)	(1)	(1)	31,434	8,918	(1)	(1)	(1)
	Dec. 31, 1913	(1)	(1)	(1)	35,711	11,521	(1)	(1)	(1)
	May 7, 1911	5,797		1,082	30,657	11,763	719	94	357
United Kingdom.....	1904	5,500	(1)	679	16,323	9,771	450	135	142
	June, 1918	12,311		2,909	27,063	277	1,916	26	232
	1917	12,382		3,008	27,867	269	1,880	25	228
	1916	12,451		3,616	28,850	293	1,834	28	230
	1915	12,171		3,795	28,276	243	1,712	29	227
	1914	12,185		3,953	27,964	242	1,851	31	245
	1910	11,765		3,561	31,165	243	2,095	31	241
Uruguay.....	1916	7,803							
	1908	8,193		180	26,286	20	556	18	
	1900	6,827		94	18,609	20	561	23	
	1860	3,632		8	1,990	5	518	8	

OTHER COUNTRIES.

Azores and Madeira Islands.....	1900	89		93	87	38	2	3	9
Basutoland.....	1911	487		(1)	1,369	(1)	88	(1)	(1)
Bechuanaland Protectorate.....	1911	324		(1)	358		4		
Bolivia.....	1913				1,750				
British Guiana.....	Mar. 31, 1916	98		14	22	15	1	2	6
Ceylon.....	1915	1,501		70	90	183	4	(1)	(1)
Chile.....	Dec. 31, 1914	1,944		229	4,545		458	42	
Colombia.....	1915	3,035		711	164		526	201	139
Costa Rica.....	1915	333		63	(⁶)	(⁸)	52	(⁸)	(⁸)
Cuba.....	Dec. 31, 1916	3,962		(1)	(1)	(1)	750	58	3
Cyprus.....	Mar. 31, 1916	63		35	282	228	70		
Dominican Republic.....		200			50	550	80		
Dutch East Indies:									
Java and Madura.....	1913	4,786		(1)	(1)	(1)	274	(1)	(1)
Other possessions.....	1905	449	447	(1)	(1)	(1)	119	(1)	(1)
Dutch Guiana.....									
East Africa Protectorate.....	Mar. 31, 1915	900	(1)	4	6,555	4,020	2	(1)	(1)
Egypt.....	1916	493	515	9	688	263	34	17	526
Falkland Islands.....	1915	8		(1)	691	(1)	4	(1)	(1)
Faroe Islands.....	1914	4		(1)	112	(1)	1		
Fiji.....	1915	59			2	12	7		
French Guiana.....	1914	400		(1)	150	140	3	(1)	(1)
French Indo-China:									
Annam.....	1914	215	(1)	(1)	(1)	(1)	(1)	(1)	(1)
Cochin-China.....	1914	109	242	709	3		(1)	(1)	(1)
Gambia.....	1907	83		(1)	(1)	(1)	4	(1)	(1)
Guam.....	1913	6		(1)	(1)	(1)	(1)	(1)	(1)
Guatemala.....	Dec. 31, 1915	620		103	383	57	116		
German East Africa.....	1913	3,994		6	6,440	25	(⁸)	(⁸)	25
German S. W. Africa.....	1913	206		8	555	517	16		14
Honduras.....	1914	489		180	6	23	68		25

¹ No official statistics.

² Reindeer.

³ Less than 500.

TABLE 195.—Live stock in principal and other countries—Continued.

OTHER COUNTRIES—Continued.

Country.	Date.	Cattle.	Buffaloes.	Swine.	Sheep.	Goats.	Horses.	Mules.	Asses.
		<i>Thousand.</i>	<i>Thousand.</i>	<i>Thousand.</i>	<i>Thousand.</i>	<i>Thousand.</i>	<i>Thousand.</i>	<i>Thousand.</i>	<i>Thousand.</i>
Iceland.....	1914	25			585	1	47		
Jamaica.....	1916	115			11	250	47		21
Luxemburg.....	Dec. 31, 1913	102		137	5	10	19	(1)	(1)
Madagascar.....	Dec. 31, 1916		26,912	544	309	200	3		
Malta.....	Mar. 31, 1916		5	4	19	20		9	
Mauritius.....	1913	41		17	2	37	2	1	(1)
Morocco:									
Western.....	1916-17	1,030		51	4,290	1,266	108	43	286
Eastern.....	1915-16	22		(1)	664	285	(1)	(1)	(1)
Newfoundland.....	1911	39		27	98	17	14	(1)	(1)
Nicaragua.....	1908	252		12	(3)	1	28	6	1
Nyasaland Protectorate.....	1916	82	*	24	30	131	(3)	(3)	(3)
Panama.....	1916	200		30		5	15	2	
Rhodesia.....	1911	500		2	300	602		20	
Salvador.....	1906	284		423	21	(1)	74	(1)	(1)
Siam.....	Jan. 1, 1916	2,337	2,120	(1)			105	(1)	(1)
Straits Settlements.....	1914	40		113	35	18	2	(1)	(1)
Swaziland.....	Mar. 31, 1916	100		9	250		1	2	
Togo ²	1913	65	(1)	(1)	(1)	(1)	(1)	(1)	(1)
Trinidad and Tobago.....	1914	13		9	2	6	5	5	(1)
Tunis.....	Apr. 30, 1916	240		10	1,148	522	31	15	84
Uganda Protectorate ²	1914	845		1	678		(3)	(3)	(3)
Venezuela.....	1912	2,004		1,618	177	1,667	191	89	313

¹ No official statistics.

² Zebus.

³ Less than 500.

TABLE 196.—Hides and skins: International trade, calendar years 1909-1917.

[This table gives the classification as found in the original returns, and the summary statements for "All countries" represent the total for each class only so far as it is disclosed in the original returns. The following kinds are included: Alligator, buffalo, calf, camel, cattle, deer, goat and kid, horse and colt, kangaroo, mule and ass, sheep and lamb, and all other kinds except furs, bird skins, sheepskins with wool on, skins of rabbits and hares, and tanned or partly tanned hides and skins. Number of pounds computed from stated number of hides and skins.]

GENERAL NOTE.—Substantially the international trade of the world. It should not be expected that the world export and import totals for any year will agree. Among sources of disagreement are these: (1) Different periods of time covered in the "year" of the various countries; (2) imports received in year subsequent to year of export; (3) want of uniformity in classification of goods among countries; (4) different practices and varying degrees of failure in recording countries of origin and ultimate destination; (5) different practices of recording reexported goods; (6) opposite methods of treating free ports; (7) clerical errors, which, it may be assumed, are not infrequent.

The exports given are domestic exports, and the imports given are imports for consumption as far as it is feasible and consistent so to express the facts. While there are some inevitable omissions, on the other hand there are some duplications because of reshipments that do not appear as such in official reports. For the United Kingdom, import figures refer to imports for consumption, when available, otherwise total imports, less exports, of "foreign and colonial merchandise." Figures for the United States include Alaska, Porto Rico, and Hawaii.

EXPORTS.

[000 omitted.]

Country.	Average, 1909-1913.	1916 (Prelim.)	1917 (Prelim.)	Country.	Average, 1909-1913.	1916 (Prelim.)	1917 (Prelim.)
<i>From—</i>	<i>Pounds.</i>	<i>Pounds.</i>	<i>Pounds.</i>	<i>From—</i>	<i>Pounds.</i>	<i>Pounds.</i>	<i>Pounds.</i>
Argentina.....	293,951	271,816		New Zealand.....	25,577	27,919	
Austria-Hungary.....	79,266			Peru.....	6,194	6,884	
Belgium.....	117,213			Russia.....	96,351		
Brazil.....	83,251	108,763	78,030	Singapore.....	6,435		
British India.....	169,857			Spain.....	17,457	11,119	11,054
Canada.....	45,469	36,000	34,000	Sweden.....	24,130		
China.....	72,751	65,522	67,614	Switzerland.....	22,866	6,076	
Chosen (Korea).....	4,944			Union of South Africa.....	50,937	58,387	47,005
Cuba.....	14,292			United Kingdom.....	38,100		
Denmark.....	21,998			United States.....	25,432	14,668	11,332
Dutch East Indies.....	16,708			Uruguay.....	71,107		
Egypt.....	10,754	7,554		Venezuela.....	9,704		
France.....	131,042	25,029		Other countries.....	225,838		
Germany.....	152,373						
Italy.....	48,427	7,010	(29)				
Mexico.....	41,013						
Netherlands.....	67,636	23,124		Total.....	1,991,133		

TABLE 196.—Hides and skins: International trade, calendar years 1909–1917—Contd.

IMPORTS.							
[000 omitted.]							
Country.	Average 1909-1913.	1916 (Prelim.)	1917 (Prelim.)	Country.	Average 1909-1913.	1916 (Prelim.)	1917 (Prelim.)
<i>Into—</i>	<i>Pounds.</i>	<i>Pounds.</i>	<i>Pounds.</i>	<i>Into—</i>	<i>Pounds.</i>	<i>Pounds.</i>	<i>Pounds.</i>
Austria-Hungary.....	87, 568			Norway.....	13, 978	9, 849	5, 435
Belgium.....	180, 930			Portugal.....	6, 803		
British India.....	20, 377			Roumania.....	7, 223		
Canada.....	46, 820	47, 135	31, 872	Russia.....	110, 142	430	
Denmark.....	9, 842			Singapore.....	9, 332		
Finland.....	10, 717	8, 254		Spain.....	19, 119	21, 736	25, 497
France.....	155, 508	77, 931		Sweden.....	25, 662		
Germany.....	440, 199			United Kingdom.....	107, 350	132, 915	
Greece.....	5, 770			United States.....	514, 248	726, 671	631, 084
Italy.....	53, 523	78, 006	39, 867	Other countries.....	54, 398		
Japan.....	6, 321	19, 454					
Netherlands.....	73, 691	13, 075		Total.....	1, 959, 521		

TABLE 197.—Meat and meat products: International trade, calendar years 1911–1917.

EXPORTS.

[Figures for 1914–1917, inclusive, are subject to revision.]

Exporting country and classification.	Average, 1911-1913.	1914.	1915.	1916.	1917.
	<i>Pounds.</i>	<i>Pounds.</i>	<i>Pounds.</i>	<i>Pounds.</i>	<i>Pounds.</i>
Argentina:					
Beef.....	940, 299, 000	939, 809, 000	915, 072, 000	1, 059, 051, 000	1, 067, 680, 000
Mutton.....	148, 457, 000	129, 384, 000	77, 250, 000	113, 136, 000	87, 787, 000
Pork.....	9, 000	779, 000	2, 304, 000	3, 381, 000	4, 034, 000
Other.....	84, 694, 000	80, 284, 000	111, 031, 000	150, 534, 000	266, 054, 000
Total.....	1, 173, 459, 000	1, 150, 256, 000	1, 105, 657, 000	1, 326, 102, 000	1, 425, 555, 000
Australia:¹					
Beef.....	301, 882, 000	419, 326, 000	146, 863, 000	307, 545, 000	
Mutton.....	149, 958, 000	193, 264, 000	38, 344, 000	66, 813, 000	
Pork.....	6, 294, 000	2, 755, 000	902, 060	2, 720, 000	
Other.....	49, 009, 000	71, 266, 000	18, 431, 000	33, 472, 000	
Total.....	507, 143, 000	686, 611, 000	204, 540, 000	410, 550, 000	
Belgium:					
Beef.....	1, 577, 000				
Pork.....	16, 254, 000				
Other.....	109, 226, 000				
Total.....	127, 057, 000				
Canada:					
Beef.....	6, 448, 000	19, 039, 000	30, 695, 000	46, 129, 000	84, 387, 000
Mutton.....	48, 000	1, 056, 000	83, 000	188, 000	844, 000
Pork.....	47, 694, 000	80, 168, 000	156, 556, 000	211, 616, 000	233, 742, 000
Other.....	6, 051, 000	9, 818, 000	16, 361, 000	10, 785, 000	20, 469, 000
Total.....	60, 241, 000	110, 081, 000	203, 695, 000	268, 718, 000	339, 442, 000
China:					
Beef.....	8, 787, 000	18, 538, 000	15, 151, 000	40, 800, 000	36, 961, 000
Pork.....	7, 679, 000	11, 308, 000	12, 785, 000	14, 066, 000	23, 778, 000
Other.....	48, 218, 000	25, 256, 000	31, 302, 000	46, 227, 000	62, 437, 000
Total.....	64, 684, 000	55, 102, 000	59, 238, 000	101, 093, 000	123, 176, 000
Denmark:					
Beef.....	43, 485, 000				
Mutton.....	344, 000				
Pork.....	297, 174, 000				
Other.....	26, 273, 000				
Total.....	367, 276, 000				

¹ Year beginning July 1, 1914; and subsequently.

TABLE 197.—Meat and meat products: International trade, calendar years 1911–1917—Continued.

EXPORTS—Continued.

Exporting country and classification.	Average, 1911–1913.	1914.	1915.	1916.	1917.
Netherlands:	<i>Pounds.</i>	<i>Pounds.</i>	<i>Pounds.</i>	<i>Pounds.</i>	<i>Pounds.</i>
Beef.....	326,176,000	348,718,000	446,395,000
Mutton.....	17,212,000	19,894,000	25,150,000
Pork.....	139,916,000	198,420,000	144,550,000
Other.....	14,098,000	16,212,000	18,048,000
Total.....	497,402,000	583,244,000	634,143,000
New Zealand:					
Beef.....	80,543,000	125,530,000	146,851,000	62,720,000
Mutton.....	235,509,000	280,324,000	302,218,000	251,245,000
Pork.....	1,049,000	605,000	1,363,000	1,179,000
Other.....	9,437,000	10,738,000	15,019,000	12,833,000
Total.....	326,538,000	417,197,000	465,451,000	327,977,000
Russia:¹					
Beef.....	32,000	72,000	1,047,000
Mutton.....	365,000	105,000	125,000
Pork.....	28,871,000	19,515,000	5,704,000	1,011,000
Other.....	23,907,000	13,326,000	3,206,000	4,406,000
Total.....	53,175,000	33,018,000	10,082,000	5,417,000
Sweden:					
Beef.....	17,285,000	18,377,000	35,035,000	10,952,000
Mutton.....	100,000	152,000	54,000	2,000
Pork.....	19,445,000	33,618,000	42,518,000	31,787,000
Other.....	2,937,000	5,590,000	11,621,000	4,638,000
Total.....	39,767,000	57,737,000	89,228,000	47,379,000
United Kingdom:					
Beef.....	27,595,000	22,415,000	19,551,000	10,790,000
Pork.....	15,820,000	12,759,000	13,842,000	10,886,000
Other.....	73,810,000	101,917,000	89,917,000	59,331,000
Total.....	117,225,000	137,091,000	123,310,000	81,007,000
United States:					
Beef.....	213,722,000	160,756,000	534,766,000	391,442,000	401,923,000
Mutton.....	4,146,000	3,847,000	4,231,000	5,258,000	2,857,000
Pork.....	1,019,561,000	828,200,000	1,371,100,000	1,453,966,000	1,300,415,000
Other.....	40,094,000	30,526,000	41,830,000	19,491,000	25,869,000
Total.....	1,277,523,000	1,023,419,000	1,951,927,000	1,870,157,000	1,731,064,000
Other countries:					
Beef.....	11,615,000
Mutton.....	546,000
Pork.....	15,566,000
Other.....	59,894,000
Total.....	87,621,000
All countries:					
Beef.....	1,979,446,000
Mutton.....	556,685,000
Pork.....	1,615,332,000
Other.....	547,648,000
Total.....	4,699,111,000

¹ For 1916, exports over European frontier only.

TABLE 197.—Meat and meat products: International trade, calendar years 1911-1917—Continued.

IMPORTS.

Importing country and classification.	Average, 1911-1913.	1914.	1915.	1916.	1917.
	<i>Pounds.</i>	<i>Pounds.</i>	<i>Pounds.</i>	<i>Pounds.</i>	<i>Pounds.</i>
Austria-Hungary:					
Beef.....	12,983,000				
Pork.....	14,338,000				
Other.....	21,948,000				
Total.....	49,269,000				
Belgium:					
Beef.....	6,034,000				
Pork.....	22,232,000				
Other.....	150,854,000				
Total.....	179,120,000				
Brazil:					
Beef.....	47,990,000	9,116,000			
Pork.....	5,103,000	4,962,000			
Other.....	920,000	503,000			
Total.....	54,013,000	14,581,000			
Canada:					
Beef.....	3,091,000	3,532,000	5,623,000	9,783,000	19,434,000
Mutton.....	4,717,000	4,194,000	2,006,000	2,786,000	2,008,000
Pork.....	29,189,000	13,001,000	25,270,000	94,113,000	128,067,000
Other.....	6,330,000	4,212,000	3,870,000	42,494,000	28,985,000
Total.....	43,327,000	24,939,000	37,678,000	149,176,000	178,494,000
Cuba:					
Beef.....	37,822,000	27,760,000	22,655,000	42,271,000	
Mutton.....	41,000	52,000	56,000	13,000	
Pork.....	85,973,000	89,195,000	96,805,000	104,444,000	
Other.....	4,525,000	3,981,000	4,862,000	6,438,000	
Total.....	128,361,000	120,988,000	124,378,000	153,166,000	
Germany:					
Beef.....	212,150,000				
Mutton.....	1,046,000				
Pork.....	265,666,000				
Other.....	80,886,000				
Total.....	559,748,000				
Italy:					
Beef.....	131,000	108,000	215,000		
Pork.....	74,861,000	61,868,000	78,055,000		
Other.....	29,627,000	11,550,000	80,257,000		
Total.....	104,619,000	73,526,000	158,527,000		
Netherlands:					
Beef and veal.....	256,296,000	203,056,000	187,097,000		
Mutton.....	76,000	49,000	10,000		
Pork.....	88,143,000	41,904,000	51,255,000		
Other.....	15,349,000	14,043,000	8,698,000		
Total.....	359,864,000	259,052,000	247,060,000		
Norway:					
Beef.....	20,203,000	21,098,000	26,600,000	30,797,000	26,316,000
Pork.....	9,751,000	11,173,000	11,348,000	18,523,000	16,341,000
Other.....	12,460,000	14,219,000	5,048,000	7,222,000	27,116,000
Total.....	42,414,000	46,490,000	42,996,000	56,542,000	69,773,000
Russia:¹					
Beef.....	2,216,000	693,000	78,000	347,000	
Other.....	128,682,000	97,557,000	32,634,000	3,582,000	
Total.....	130,898,000	98,250,000	32,712,000	3,929,000	

¹ 1916 figures are for over European frontier only.

TABLE 197.—Meat and meat products: International trade, calendar years 1911–1917—Continued.

IMPORTS—Continued.

Importing country and classification.	Average, 1911–1913.	1914.	1915.	1916.	1917.
Spain:	<i>Pounds.</i>	<i>Pounds.</i>	<i>Pounds.</i>	<i>Pounds.</i>	<i>Pounds.</i>
Beef.....	966,000	24,000	80,000	160,000	167,000
Pork.....	553,000	368,000	1,760,000	5,881,000	1,050,000
Other.....	36,455,000	34,526,000	29,477,000	24,458,000	24,696,000
Total.....	37,974,000	34,918,000	31,317,000	30,499,000	25,913,000
Sweden:					
Beef.....	12,912,000	17,312,000	19,202,000	15,877,000
Mutton.....	1,218,000	522,000	116,000	26,000
Pork.....	6,736,000	6,069,000	9,833,000	6,572,000
Other.....	3,349,000	3,450,000	6,622,000	2,435,000
Total.....	24,215,000	27,353,000	35,773,000	24,910,000
Switzerland:					
Beef.....	9,052,000	4,544,000	5,990,000	6,354,000
Pork.....	21,976,000	11,034,000	8,765,000	6,646,000
Other.....	25,298,000	10,802,000	5,532,000	5,251,000
Total.....	56,326,000	26,380,000	20,287,000	18,251,000
United Kingdom:					
Beef.....	1,413,965,000	1,490,483,000	1,669,573,000	1,471,188,000
Mutton.....	598,657,000	589,233,000	533,936,000	412,202,000
Pork.....	919,794,000	988,328,000	1,186,132,000	1,261,082,000
Other.....	124,530,000	133,912,000	138,403,000	113,993,000
Total.....	3,056,946,000	3,201,956,000	3,528,044,000	3,258,465,000
United States:					
Beef.....	17,668,000	258,349,000	120,308,000	40,421,000	27,628,000
Mutton.....	185,000	19,876,000	11,879,000	17,235,000	5,624,000
Pork.....	171,000	26,835,000	5,496,000	1,171,000	2,821,000
Other.....	696,000	499,000	98,000	4,000	13,000
Total.....	18,720,000	305,559,000	137,781,000	58,831,000	36,086,000
Other countries:					
Beef.....	68,773,000
Mutton.....	9,310,000
Pork.....	56,704,000
Other.....	27,412,000
Total.....	162,199,000
All countries:					
Beef.....	2,122,252,000
Mutton.....	615,250,000
Pork.....	1,601,190,000
Other.....	669,321,000
Total.....	5,008,013,000

HORSES AND MULES.

TABLE 198.—Horses and mules: Number and value on farms in the United States, 1867-1919.

NOTE.—Figures in *italics* are census returns; figures in roman are estimates of the Department of Agriculture. Estimates of numbers are obtained by applying estimated percentages of increase or decrease to the published numbers of the preceding year, except that a revised base is used for applying percentage estimates whenever new census data are available. It should also be observed that the census of 1910, giving numbers as of A pr. 15, is not strictly comparable with former censuses, which related to numbers June 1.

Jan. 1—	Horses.			Mules.		
	Number.	Price per head Jan. 1.	Farm value Jan. 1.	Number.	Price per head Jan. 1.	Farm value Jan. 1.
1867.....	5,401,000	\$59.05	\$318,924,000	822,000	\$66.94	\$55,048,000
1868.....	5,757,000	54.27	312,416,000	856,000	56.04	47,954,000
1869.....	6,333,000	62.57	398,222,000	922,000	79.23	73,027,000
1870.....	8,249,000	67.43	556,251,000	1,180,000	90.42	106,654,000
1870, census, June 1.....	<i>7,146,370</i>			<i>1,126,415</i>		
1871.....	8,702,000	71.14	619,039,000	1,242,000	91.98	114,272,000
1872.....	8,991,000	67.41	606,111,000	1,276,000	87.14	111,222,000
1873.....	9,222,000	66.39	612,273,000	1,310,000	85.15	111,546,000
1874.....	9,334,000	65.15	608,073,000	1,339,000	81.35	108,953,000
1875.....	9,504,000	61.10	580,708,000	1,394,000	71.89	100,197,000
1876.....	9,935,000	57.29	557,747,000	1,414,000	66.46	94,001,000
1877.....	10,155,000	55.83	567,017,000	1,444,000	64.07	92,482,000
1878.....	10,330,000	56.63	584,999,000	1,638,000	62.03	101,579,000
1879.....	10,939,000	52.36	572,712,000	1,713,000	56.00	95,942,000
1880.....	11,202,000	54.75	613,297,000	1,730,000	61.26	105,948,000
1880, census, June 1.....	<i>10,557,488</i>			<i>1,812,808</i>		
1881.....	11,430,000	58.44	667,954,000	1,721,000	69.79	120,096,000
1882.....	10,522,000	58.53	615,825,000	1,835,000	71.35	130,945,000
1883.....	10,838,000	70.59	765,041,000	1,871,000	79.49	148,732,000
1884.....	11,170,000	74.64	833,734,000	1,914,000	84.22	161,215,000
1885.....	11,565,000	73.70	852,283,000	1,973,000	82.38	162,497,000
1886.....	12,078,000	71.27	860,823,000	2,053,000	79.60	163,381,000
1887.....	12,497,000	72.15	901,686,000	2,117,000	78.91	167,058,000
1888.....	13,173,000	71.82	946,096,000	2,192,000	79.78	174,854,000
1889.....	13,663,000	71.89	932,195,000	2,258,000	79.49	179,444,000
1890.....	14,214,000	68.84	978,517,000	2,331,000	78.25	182,394,000
1890, census, June 1.....	<i>14,969,467</i>			<i>2,295,532</i>		
1891.....	14,057,000	67.00	941,823,000	2,297,000	77.88	178,847,000
1892.....	15,498,000	65.01	1,007,594,000	2,315,000	75.55	174,882,000
1893.....	16,207,000	61.22	992,225,000	2,331,000	70.68	164,764,000
1894.....	16,081,000	47.83	769,225,000	2,352,000	62.17	146,233,000
1895.....	15,893,000	36.29	576,731,000	2,333,000	47.55	110,928,000
1896.....	15,124,000	33.07	500,140,000	2,279,000	45.29	103,204,000
1897.....	14,365,000	31.51	452,649,000	2,216,000	41.66	92,302,000
1898.....	13,961,000	34.26	478,362,000	2,190,000	43.88	96,110,000
1899.....	13,665,000	37.40	511,075,000	2,134,000	44.96	95,963,000
1900.....	13,538,000	44.61	603,969,000	2,086,000	53.55	111,717,000
1900, census, June 1.....	<i>18,267,020</i>			<i>3,264,616</i>		
1901 ¹	16,745,000	52.86	885,200,000	2,864,000	63.97	183,232,000
1902.....	16,531,000	58.61	968,935,000	2,757,000	67.61	186,412,000
1903.....	16,557,000	62.25	1,030,706,000	2,728,000	72.49	197,753,000
1904.....	16,736,000	67.93	1,136,940,000	2,758,000	73.88	217,533,000
1905.....	17,053,000	70.37	1,200,310,000	2,889,000	87.18	251,840,000
1906.....	18,719,000	80.72	1,510,890,000	3,404,000	98.31	334,681,000
1907.....	19,747,000	93.51	1,846,578,000	3,817,000	112.16	428,064,000
1908.....	19,992,000	93.41	1,867,530,000	3,869,000	107.76	416,939,000
1909.....	20,640,000	95.64	1,974,052,000	4,053,000	107.84	437,082,000
1910.....	21,040,000			4,123,000		
1910, census, A pr. 15.....	<i>19,833,113</i>	108.03	2,142,524,000	<i>4,209,769</i>	120.20	506,049,000
1911 ¹	20,277,000	111.46	2,259,981,000	4,323,000	125.92	544,359,000
1912.....	20,509,000	105.94	2,172,694,000	4,362,000	120.51	525,657,000
1913.....	20,567,000	110.77	2,278,222,000	4,386,000	124.31	545,245,000
1914.....	20,962,000	109.32	2,291,638,000	4,449,000	123.85	551,017,000
1915.....	21,195,000	103.33	2,190,102,000	4,479,000	112.36	503,271,000
1916.....	21,159,000	101.60	2,149,786,000	4,593,000	112.83	522,834,000
1917.....	21,210,000	102.89	2,182,307,000	4,723,000	118.15	558,006,000
1918.....	21,555,000	104.24	2,246,970,000	4,873,000	128.81	627,679,000
1919.....	21,534,000	98.48	2,120,709,000	4,925,000	135.59	667,767,000

¹ Estimates of numbers revised, based on census data.

HORSES AND MULES—Continued.

TABLE 199.—Horses and mules: Number and value on farms Jan. 1, 1918 and 1919, by States.

State.	Horses.						Mules.					
	Number (thousands) Jan. 1—		Average price per head Jan. 1—		Farm value (thousands of dollars) Jan. 1—		Number (thousands) Jan. 1—		Average price per head Jan. 1—		Farm value (thousands of dollars) Jan. 1—	
	1919	1918	1919	1918	1919	1918	1919	1918	1919	1918	1919	1918
Maine.....	107	108	\$154.00	\$163.00	16,478	17,604
New Hampshire.....	42	43	145.00	151.00	6,090	6,493
Vermont.....	88	88	139.00	144.00	12,232	12,672
Massachusetts.....	54	57	157.00	163.00	8,478	9,291
Rhode Island.....	8	8	159.00	155.00	1,272	1,240
Connecticut.....	44	45	164.00	161.00	7,216	7,245
New York.....	578	590	139.00	145.00	80,342	85,550	6	6	\$139.00	\$159.00	831	954
New Jersey.....	89	90	143.00	153.00	12,727	13,770	4	4	167.00	174.00	688	696
Pennsylvania.....	578	590	124.00	126.00	71,672	74,340	48	48	129.00	138.00	6,192	6,624
Delaware.....	35	36	92.00	87.00	3,220	3,132	6	6	122.00	115.00	732	690
Maryland.....	171	171	104.00	102.00	17,784	17,442	25	25	133.00	124.00	3,325	3,100
Virginia.....	339	365	109.00	104.00	40,221	37,960	66	65	138.00	128.00	9,108	8,320
West Virginia.....	194	196	101.00	106.00	19,594	20,776	12	12	115.00	116.00	1,380	1,392
North Carolina.....	181	187	146.00	140.00	23,426	26,180	208	210	176.00	167.00	36,608	35,070
South Carolina.....	82	80	180.00	156.00	14,760	12,480	194	185	206.00	192.00	39,964	35,520
Georgia.....	131	130	156.00	145.00	20,436	18,850	344	334	200.00	181.00	68,800	60,454
Florida.....	62	62	129.00	127.00	7,998	7,874	35	34	177.00	172.00	6,125	5,848
Ohio.....	891	900	107.00	112.00	93,337	100,800	28	27	117.00	118.00	3,276	3,186
Indiana.....	829	837	103.00	105.00	85,387	87,885	94	95	125.00	119.00	11,750	11,305
Illinois.....	1,467	1,467	100.00	103.00	146,700	151,101	147	150	125.00	120.00	18,375	18,000
Michigan.....	666	673	105.00	118.00	69,930	79,414	4	4	106.00	119.00	424	476
Wisconsin.....	694	708	109.00	117.00	75,646	82,836	3	3	111.00	117.00	333	351
Minnesota.....	950	950	98.00	105.00	93,100	99,750	6	6	110.00	111.00	660	666
Iowa.....	1,567	1,583	95.00	104.00	148,865	164,632	68	69	113.00	116.00	7,684	8,004
Missouri.....	1,040	1,040	92.00	97.00	95,680	100,880	374	367	116.00	113.00	43,384	41,471
North Dakota.....	850	842	93.00	102.00	79,050	85,884	9	9	107.00	121.00	963	1,089
South Dakota.....	827	811	80.00	95.00	66,160	77,045	16	16	99.00	109.00	1,584	1,744
Nebraska.....	1,049	1,049	87.00	101.00	91,263	105,949	109	118	109.00	113.00	11,831	13,334
Kansas.....	1,153	1,142	94.00	104.00	108,382	118,768	260	280	114.00	118.00	23,640	33,040
Kentucky.....	439	443	104.00	101.00	45,656	44,743	231	224	127.00	122.00	29,337	27,328
Tennessee.....	357	350	116.00	109.00	41,412	38,150	278	273	140.00	131.00	38,920	35,763
Alabama.....	155	153	128.00	116.00	19,840	17,748	304	289	157.00	141.00	47,728	40,749
Mississippi.....	256	253	113.00	100.00	28,928	25,300	316	307	139.00	124.00	43,924	38,068
Louisiana.....	213	207	97.00	93.00	20,661	19,251	164	156	145.00	135.00	23,780	21,000
Texas.....	1,164	1,212	78.00	77.00	90,792	93,324	792	808	115.00	107.00	91,080	86,456
Oklahoma.....	744	737	83.00	94.00	61,752	69,278	288	280	110.00	114.00	31,680	31,920
Arkansas.....	237	272	93.00	97.00	24,831	28,384	315	292	123.00	125.00	38,745	36,500
Montana.....	557	506	84.00	98.00	46,788	49,588	5	5	99.00	105.00	495	525
Wyoming.....	230	215	77.00	82.00	17,710	17,630	4	4	103.00	104.00	424	416
Colorado.....	419	399	91.00	97.00	38,129	38,703	31	30	107.00	108.00	3,317	3,240
New Mexico.....	261	272	62.00	62.00	16,182	16,864	20	19	92.00	89.00	1,840	1,691
Arizona.....	136	135	71.00	71.00	9,656	9,585	9	9	112.00	108.00	1,008	972
Utah.....	148	145	83.00	89.00	12,284	12,905	2	2	78.00	82.00	156	164
Nevada.....	75	75	62.00	77.00	4,650	5,775	3	3	72.00	80.00	216	240
Idaho.....	276	265	89.00	99.00	24,564	26,235	4	4	98.00	105.00	392	420
Washington.....	303	300	92.00	108.00	27,876	32,400	20	19	108.00	117.00	2,160	2,223
Oregon.....	303	300	89.00	98.00	26,967	29,400	10	10	93.00	102.00	930	1,020
California.....	435	468	91.00	98.00	39,585	45,864	63	66	125.00	115.00	7,875	7,590
United States.....	21,534	21,555	98.48	104.24	2,120,705	2,246,970	4,925	4,873	135.59	128.81	667,767	627,679

HORSES AND MULES—Continued.

TABLE 200.—Prices of horses and mules at St. Louis, 1900–1918.

Year and month.	Horses good to choice, draft.		Mules 16 to 16½ hands.		Year and month.	Horses good to choice, draft.		Mules 16 to 16½ hands.	
	Low.	High.	Low.	High.		Low.	High.	Low.	High.
1900.....	\$140.00	\$190.00	\$90.00	\$150.00	1917. July..... August..... September..... October..... November..... December..... Year, 1917..... 1918. January..... February..... March..... April..... May..... June..... July..... August..... September..... October..... November..... December..... Year, 1918.....	\$160.00	\$270.00	\$175.00	\$275.00
1901.....	150.00	175.00	110.00	165.00		150.00	235.00	175.00	275.00
1902.....	160.00	185.00	120.00	160.00		160.00	220.00	200.00	275.00
1903.....	160.00	185.00	120.00	175.00		160.00	220.00	200.00	280.00
1904.....	175.00	200.00	135.00	200.00		160.00	220.00	200.00	260.00
1905.....	175.00	225.00	120.00	210.00		160.00	220.00	190.00	260.00
1906.....	175.00	225.00	125.00	215.00		160.00	220.00	200.00	265.00
1907.....	175.00	225.00	125.00	250.00		165.00	245.00	172.00	272.00
1908.....	175.00	270.00	125.00	200.00		160.00	200.00	200.00	265.00
1909.....	140.00	227.00	130.00	225.00		185.00	220.00	225.00	250.00
1910.....	165.00	240.00	150.00	275.00		190.00	235.00	225.00	310.00
1911.....	165.00	235.00	150.00	275.00		195.00	255.00	200.00	290.00
1912.....	165.00	240.00	160.00	285.00		225.00	250.00	200.00	300.00
1913.....	200.00	270.00	160.00	280.00		230.00	280.00	200.00	325.00
1914.....	175.00	220.00	120.00	250.00		230.00	280.00	200.00	325.00
1915.....	160.00	225.00	120.00	275.00		150.00	185.00	180.00	300.00
1916.....	150.00	225.00	135.00	275.00	130.00	160.00	180.00	300.00	
1917.....	150.00	240.00	150.00	275.00	199.00	242.00	201.00	307.00	
January.....	160.00	270.00	150.00	270.00					
February.....	160.00	270.00	150.00	270.00					
March.....	160.00	270.00	150.00	270.00					
April.....	160.00	270.00	150.00	270.00					
May.....	160.00	270.00	150.00	270.00					
June.....	160.00	270.00	150.00	270.00					

TABLE 201.—Horses: Farm price per head, 15th of month, 1910–1918.

	1918	1917	1916	1915	1914	1913	1912	1911	1910
Jan. 15.....	\$130	\$129	\$128	\$130	\$137	\$140	\$134	\$143	\$140
Feb. 15.....	133	131	129	132	139	146	137	144	147
Mar. 15.....	137	133	131	132	138	146	140	145	150
Apr. 15.....	137	136	133	132	138	148	142	147	154
May 15.....	136	138	134	133	139	145	144	146	148
June 15.....	135	137	132	132	136	146	145	145	151
July 15.....	132	135	133	134	137	143	142	139	148
Aug. 15.....	131	132	131	131	135	141	142	141	148
Sept. 15.....	128	132	131	131	132	141	141	139	145
Oct. 15.....	126	130	130	129	131	138	140	137	144
Nov. 15.....	122	129	129	127	130	136	139	136	143
Dec. 15.....	121	129	129	126	130	135	139	134	141

HORSES AND MULES—Continued.

TABLE 202.—Average price per head for horses on the Chicago horse market, 1902–1918.

Year and month.	Drafters.	Carriage teams.	Drivers.	General.	Bussers, trammers.	Cavalry horses. ¹	Southern chunks.
1902.....	\$166.00	\$450.00	\$145.00	\$117.00	\$135.00	\$151.00	\$57.00
1903.....	171.00	455.00	150.00	122.00	140.00	156.00	62.00
1904.....	177.00	475.00	150.00	140.00	140.00	160.00	64.00
1905.....	186.00	486.00	156.00	132.00	145.00	172.00	70.00
1906.....	188.00	486.00	158.00	154.00	147.00	174.00	72.50
1907.....	194.00	482.00	165.00	137.00	152.00	172.00	77.50
1908.....	190.00	450.00	156.00	129.00	138.00	164.00	69.00
1909.....	194.00	482.00	165.00	137.00	152.00	172.00	77.00
1910.....	200.00	473.00	172.00	144.00	161.00	177.00	87.00
1911.....	205.00	483.00	182.00	155.00	170.00	190.00	92.00
1912.....	210.00	473.00	177.00	160.00	175.00	195.00	97.00
1913.....	213.00	493.00	174.00	165.00	176.00	189.00	98.00
1914.....	208.00	483.00	169.00	160.00	171.00	184.00	93.00
1915.....	235.00	473.00	164.00	155.00	166.00	179.00	88.00
1916.....	252.00	166.00	160.00	167.00	124.00	109.00
1917.							
January.....	205.00	430.00	160.00	150.00	165.00	180.00	90.00
February.....	215.00	475.00	170.00	145.00	170.00	195.00	90.00
March.....	225.00	490.00	170.00	155.00	175.00	200.00	100.00
April.....	229.00	485.00	175.00	160.00	180.00	200.00	105.00
May.....	225.00	490.00	170.00	155.00	180.00	195.00	95.00
June.....	229.00	495.00	165.00	150.00	175.00	195.00	100.00
July.....	210.00	490.00	165.00	150.00	170.00	190.00	95.00
August.....	210.00	480.00	165.00	145.00	170.00	190.00	90.00
September.....	235.00	460.00	160.00	140.00	165.00	185.00	90.00
October.....	230.00	450.00	155.00	145.00	170.00	175.00	90.00
November.....	230.00	445.00	150.00	140.00	165.00	175.00	85.00
December.....	205.00	450.00	150.00	140.00	160.00	170.00	90.00
Year 1917.....	212.00	470.00	162.00	148.00	170.00	188.00	93.00
1918.							
January.....	215.00
February.....	215.00
March.....	220.00
April.....	230.00
May.....	230.00
June.....	225.00
July.....	220.00
August.....	215.00
September.....	215.00
October.....	220.00
November.....	215.00
December.....	215.00
Year 1918.....	219.58

¹ "Saddlers" prior to 1916.

HORSES AND MULES—Continued.

TABLE 203.—Number of horses and mules received at principal live-stock markets, 1900-1918.

[From reports of stockyards companies.]

Year and month.	Horses.			Horses and mules.					Total 8 cities.
	Chicago.	St. Paul.	Denver.	Fort Worth.	Kansas City.	Omaha.	St. Joseph.	St. Louis National Stock-yards, Ill.	
1900.....	99,010	26,778	22,691	103,308	59,645	13,497	144,921	469,850
1901.....	109,353	15,123	16,545	96,657	36,391	22,521	128,880	425,470
1902.....	102,100	8,162	24,428	4,872	76,844	42,079	19,909	109,295	387,689
1903.....	100,603	7,823	19,040	10,094	67,274	52,829	20,483	128,615	406,761
1904.....	105,949	6,438	13,437	17,895	67,562	46,845	28,704	181,341	468,171
1905.....	127,250	5,561	16,046	18,033	65,582	45,422	31,565	178,257	487,716
1906.....	126,979	9,299	16,571	21,303	69,629	42,269	28,480	166,393	480,923
1907.....	102,055	14,557	11,059	18,537	62,341	44,020	26,894	117,379	396,812
1908.....	92,138	7,125	11,158	12,435	56,335	39,998	22,875	109,393	351,457
1909.....	91,411	5,632	15,348	20,732	67,796	31,711	23,132	122,471	378,233
1910.....	83,439	5,482	15,554	34,445	69,628	29,734	27,583	130,271	396,136
1911.....	104,545	7,709	18,022	37,361	84,861	31,771	42,023	170,379	496,671
1912.....	92,977	5,314	14,918	49,025	73,445	32,520	38,661	163,973	470,833
1913.....	90,615	5,203	16,274	56,724	82,110	31,580	32,418	156,825	471,749
1914.....	106,282	5,683	16,957	47,712	87,155	30,688	25,424	148,128	468,029
1915.....	165,253	10,091	71,870	53,640	102,153	41,679	41,254	270,612	756,552
1916.....	205,449	11,777	52,800	79,209	123,141	27,486	27,206	266,818	793,886
1917.									
January.....	10,788	496	2,095	7,322	15,144	1,724	2,625	24,957	65,151
February.....	6,413	544	1,701	2,763	14,432	2,108	1,978	15,068	44,977
March.....	11,111	895	1,143	4,203	14,235	3,229	2,958	16,874	54,648
April.....	7,601	598	1,154	4,420	13,233	2,641	1,862	13,370	44,909
May.....	7,550	465	1,755	1,742	5,379	1,235	733	8,198	27,057
June.....	7,258	476	2,137	3,793	2,578	1,044	452	6,852	24,600
July.....	8,351	553	1,305	9,156	4,171	1,889	821	15,659	41,915
August.....	4,628	405	849	9,312	3,776	1,424	1,301	13,963	35,658
September.....	7,274	1,261	1,035	14,523	10,313	5,465	3,438	31,267	74,576
October.....	11,329	1,158	2,551	30,647	13,936	6,341	5,908	51,291	123,161
November.....	15,823	1,704	2,014	18,332	17,861	3,892	6,367	47,743	113,736
December.....	9,175	1,404	2,019	9,020	12,765	1,789	5,131	34,595	75,898
Total, 1917.....	107,311	9,959	19,758	115,233	127,823	32,781	33,584	279,837	726,286
1918.									
January.....	6,002	1,160	2,341	9,821	14,020	2,150	4,445	33,746	73,685
February.....	5,997	504	961	7,239	11,688	1,751	5,877	33,071	67,088
March.....	8,086	573	1,840	6,020	11,544	2,261	5,154	28,010	63,488
April.....	5,620	271	750	3,696	1,971	658	1,293	7,120	21,379
May.....	6,594	422	835	1,599	1,811	534	971	5,201	17,967
June.....	10,727	990	655	5,85	1,977	966	705	6,035	22,640
July.....	9,691	863	730	2,760	2,201	3,242	1,974	8,943	30,404
August.....	8,599	456	1,625	5,887	5,387	3,203	4,039	17,517	46,713
September.....	6,101	339	1,590	15,088	9,919	3,764	5,317	31,522	73,640
October.....	8,382	544	1,571	13,680	12,401	2,181	4,542	30,183	73,484
November.....	9,267	280	1,093	7,883	7,644	1,064	2,972	24,819	55,022
December.....	2,754	139	608	4,623	4,065	438	1,971	15,584	30,182
Total, 1918.....	87,820	6,541	14,599	78,881	84,628	22,212	39,260	241,751	575,692

HORSES AND MULES—Continued.

TABLE 204.—Horses and mules: Imports, exports, and prices, 1893–1918.

Year ending June 30—	Imports of horses.			Exports of horses.			Exports of mules.		
	Number.	Value.	Average import price.	Number.	Value.	Average export price.	Number.	Value.	Average export price.
1893.....	15,451	\$2,388,267	\$154.57	2,967	\$718,607	\$242.20	1,634	\$210,278	\$128.69
1894.....	6,166	1,319,572	214.01	5,246	1,108,995	211.40	2,063	240,961	116.80
1895.....	13,098	1,055,191	80.56	13,984	2,209,208	157.99	2,515	183,452	74.14
1896.....	9,991	662,591	66.32	25,126	3,530,703	140.52	5,918	403,161	68.63
1897.....	6,998	464,808	66.42	39,532	4,769,265	120.64	7,473	545,331	72.97
1898.....	3,085	414,899	134.49	51,150	6,176,569	120.75	8,098	664,789	82.09
1899.....	3,042	551,050	181.15	45,778	5,444,342	118.93	6,755	516,908	76.52
1900.....	3,102	596,592	192.32	64,722	7,612,616	117.62	43,309	3,919,478	90.38
1901.....	3,785	985,738	260.43	82,250	8,873,845	107.89	34,405	3,210,257	93.31
1902.....	4,832	1,577,234	326.41	103,020	10,048,046	97.53	27,586	2,692,298	97.60
1903.....	4,909	1,536,296	307.32	34,007	3,152,159	92.69	4,294	521,725	121.47
1904.....	4,726	1,400,287	308.99	42,001	3,183,100	75.93	3,658	412,971	112.90
1905.....	5,180	1,591,083	307.16	34,822	3,175,259	91.19	5,826	645,464	110.79
1906.....	6,021	1,716,675	285.11	40,087	4,305,981	108.91	7,167	883,639	138.08
1907.....	6,080	1,978,105	325.35	33,882	4,359,957	131.99	6,781	850,901	125.48
1908.....	5,487	1,604,392	292.40	19,000	2,612,587	137.50	6,609	990,667	149.90
1909.....	7,034	2,007,276	283.35	21,616	3,383,617	156.67	3,432	472,017	137.53
1910.....	11,020	3,293,022	283.65	28,910	4,061,157	141.17	4,512	614,094	136.18
1911.....	9,593	2,692,074	280.63	25,145	3,845,253	152.92	6,585	1,070,051	162.50
1912.....	6,607	1,923,025	291.06	34,828	4,764,815	136.81	4,901	732,095	149.30
1913.....	10,008	2,125,875	212.42	28,707	3,960,102	137.95	4,744	733,795	154.68
1914.....	33,019	2,605,029	78.89	22,776	3,388,819	148.79	4,883	690,974	141.51
1915.....	12,652	977,350	77.25	289,340	64,046,534	221.35	65,788	12,723,143	193.44
1916.....	15,556	1,618,245	104.03	357,553	73,531,146	205.65	111,915	22,940,312	205.03
1917.....	12,584	1,888,303	150.06	278,674	59,525,329	213.00	136,689	27,800,854	203.39
1918.....	5,099	1,187,443	232.88	84,765	14,923,663	176.06	28,879	4,885,406	169.17

CATTLE.

TABLE 205.—Cattle (live): Imports, exports, and prices, 1893–1918.

Year ending June 30—	Imports.			Exports.		
	Number.	Value.	Average import price.	Number.	Value.	Average export price.
1893.....	3,293	\$45,682	\$13.87	287,094	\$26,032,428	\$90.68
1894.....	1,592	18,704	11.75	359,278	33,461,922	93.14
1895.....	149,781	765,853	5.11	331,722	30,603,796	92.26
1896.....	217,826	1,509,856	6.93	372,461	34,560,672	92.79
1897.....	328,977	2,589,857	7.87	392,190	36,357,451	92.70
1898.....	231,589	2,913,223	9.99	439,255	37,827,500	86.12
1899.....	199,752	2,320,362	11.62	389,490	30,516,833	78.35
1900.....	181,006	2,257,694	12.47	307,286	30,635,153	77.11
1901.....	146,022	1,931,433	13.23	459,218	37,566,980	81.81
1902.....	96,027	1,608,722	16.75	392,884	29,902,212	76.11
1903.....	66,175	1,161,548	17.55	402,178	29,848,936	74.22
1904.....	16,056	310,737	19.35	593,409	42,256,291	71.21
1905.....	27,855	458,572	16.46	567,806	40,598,048	71.50
1906.....	29,019	548,430	18.90	584,239	42,081,170	72.03
1907.....	32,402	565,122	17.44	423,051	34,577,392	81.73
1908.....	92,356	1,507,310	16.32	349,210	29,339,134	84.02
1909.....	139,184	1,909,422	14.37	207,542	18,046,976	86.96
1910.....	195,938	2,909,824	15.37	139,430	12,200,154	87.50
1911.....	182,923	2,953,077	16.14	150,100	13,163,920	87.70
1912.....	118,372	4,805,574	15.09	105,506	8,870,075	84.07
1913.....	421,649	6,640,668	15.75	24,714	1,177,199	47.63
1914.....	868,368	18,696,718	21.53	18,376	647,288	35.22
1915.....	538,167	17,513,175	32.54	5,484	702,847	128.16
1916.....	439,185	15,187,593	34.58	21,666	2,383,765	110.02
1917.....	374,826	13,021,259	34.74	13,387	949,503	70.93
1918.....	233,719	17,852,176	60.78	18,213	1,247,800	68.51

CATTLE—Continued.

TABLE 206.—Cattle: Number and value on farms in the United States, 1867-1919.

NOTE.—Figures in *italics* are census returns; figures in roman are estimates of the Department of Agriculture. Estimates of numbers are obtained by applying estimated percentages of increase or decrease to the published numbers of the preceding year, except that a revised base is used for applying percentage estimates whenever new census data are available. It should also be observed that the census of 1910, giving numbers as of Apr. 15, is not strictly comparable with former censuses, which related to numbers June 1.

Jan. 1—	Milch cows.			Other cattle.		
	Number.	Price per head Jan. 1.	Farm value Jan. 1.	Number.	Price per head Jan. 1.	Farm value Jan. 1.
1867.....	8,349,000	\$28.74	\$239,947,000	11,731,000	\$15.79	\$185,254,000
1868.....	8,632,000	26.56	270,817,000	11,942,000	15.06	179,883,000
1869.....	9,243,000	29.15	269,610,000	12,185,000	18.73	228,153,000
1870.....	10,095,000	32.70	330,175,000	15,388,000	18.87	290,401,000
1870, census June 1.....	<i>8,935,333</i>			<i>15,566,005</i>		
1871.....	10,023,000	33.89	339,701,000	16,212,000	20.78	336,860,000
1872.....	10,204,000	29.45	303,428,000	16,390,000	18.12	296,972,000
1873.....	10,576,000	26.72	282,559,000	16,414,000	18.06	296,448,000
1874.....	10,705,000	25.63	274,326,000	16,218,000	17.55	284,706,000
1875.....	10,907,000	25.74	280,701,000	16,313,000	16.91	275,872,000
1876.....	11,085,000	25.61	283,879,000	16,785,000	17.00	285,387,000
1877.....	11,261,000	25.47	259,778,000	17,956,000	15.99	287,156,000
1878.....	11,309,000	25.74	290,803,000	19,223,000	16.72	321,346,000
1879.....	11,826,000	21.71	255,721,000	21,408,000	15.38	329,254,000
1880.....	12,027,000	23.27	279,899,000	21,231,000	16.10	341,761,000
1880, census June 1.....	<i>12,443,120</i>			<i>22,488,550</i>		
1881.....	12,369,000	23.95	296,277,000	20,939,000	17.33	362,862,000
1882.....	12,612,000	25.89	326,489,000	23,230,000	19.89	463,070,000
1883.....	13,126,000	30.21	396,575,000	28,046,000	21.81	611,549,000
1884.....	13,531,000	31.37	423,427,000	29,046,000	23.52	683,229,000
1885.....	13,905,000	29.70	412,903,000	29,867,000	23.25	694,383,000
1886.....	14,235,000	27.40	389,988,000	31,275,000	21.17	661,956,000
1887.....	14,522,000	26.08	378,799,000	33,512,000	19.79	663,138,000
1888.....	14,856,000	24.65	366,222,000	34,378,000	17.09	611,751,000
1889.....	15,299,000	23.94	366,226,000	35,002,000	17.75	597,277,000
1890.....	15,953,000	22.14	353,152,000	36,849,000	15.21	560,625,000
1890, census June 1.....	<i>16,511,950</i>			<i>33,734,128</i>		
1891.....	16,020,000	21.62	346,398,000	36,876,000	14.76	544,128,000
1892.....	16,415,000	21.40	351,378,000	37,051,000	15.16	570,749,000
1893.....	16,424,000	21.75	357,300,000	35,054,000	15.24	547,882,000
1894.....	16,487,000	21.77	353,999,000	36,638,000	14.66	536,790,000
1895.....	16,505,000	21.97	362,602,000	34,364,000	14.06	482,999,000
1896.....	16,138,000	22.55	363,956,000	32,085,000	15.86	508,928,000
1897.....	15,942,000	23.16	369,240,000	30,538,000	16.65	537,920,000
1898.....	15,841,000	27.45	434,814,000	29,264,000	23.92	612,297,000
1899.....	15,993,000	29.66	474,274,000	27,994,000	22.79	677,971,000
1900.....	16,292,000	31.60	514,812,000	27,610,000	24.97	689,486,000
1900, census June 1.....	<i>17,135,633</i>			<i>50,685,777</i>		
1901.....	16,834,000	30.00	505,093,000	45,500,000	19.97	906,644,000
1902.....	16,697,000	29.23	488,130,000	44,728,000	18.76	839,126,000
1903.....	17,105,000	30.21	516,712,000	44,629,000	18.45	824,055,000
1904.....	17,423,000	29.21	508,841,000	43,629,000	16.32	712,178,000
1905.....	17,572,000	27.44	482,272,000	43,669,000	15.15	661,571,000
1906.....	19,794,000	29.44	582,789,000	47,068,000	15.85	746,172,000
1907.....	20,963,000	31.00	645,407,000	51,566,000	17.10	881,557,000
1908.....	21,194,000	30.67	650,067,000	50,073,000	16.89	845,938,000
1909.....	21,720,000	32.36	702,945,000	49,379,000	17.49	863,754,000
1910.....	21,801,000			47,279,000		
1910, census Apr. 15.....	<i>20,625,432</i>	35.29	727,802,000	<i>47,178,434</i>	19.07	785,261,000
1911.....	20,823,000	39.97	832,209,000	39,679,000	20.54	815,184,000
1912.....	20,699,000	39.39	815,414,000	37,260,000	21.20	790,064,000
1913.....	20,497,000	45.02	922,783,000	36,030,000	26.36	949,645,000
1914.....	20,777,000	53.94	1,118,487,000	35,855,000	31.13	1,116,333,000
1915.....	21,262,000	55.33	1,176,338,000	37,067,000	33.38	1,237,376,000
1916.....	22,108,000	53.92	1,191,955,000	39,812,000	33.53	1,334,928,000
1917.....	22,894,000	59.63	1,365,251,000	41,689,000	35.88	1,497,621,000
1918.....	23,310,000	70.54	1,644,231,000	44,112,000	43.88	1,803,482,000
1919.....	23,467,000	78.24	1,836,055,000	44,399,000	44.16	1,960,670,000

¹ Estimates of numbers revised, based on census data.

CATTLE—Continued.

TABLE 207.—Cattle: Number and value on farms, Jan. 1, 1918 and 1919, by States.

State.	Milch cows.						Other cattle.					
	Number (thousands) Jan. 1—		Average price per head Jan. 1—		Farm value (thousands of dollars) Jan. 1—		Number (thousands) Jan. 1—		Average price per head Jan. 1—		Farm value (thousands of dollars) Jan. 1—	
	1919	1918	1919	1918	1919	1918	1919	1918	1919	1918	1919	1918
Maine.....	175	170	\$70.50	\$75.00	12,338	12,750	142	127	\$36.10	\$37.60	5,126	4,775
New Hampshire.....	107	102	80.00	85.00	8,560	8,670	74	70	39.80	40.00	2,945	2,800
Vermont.....	281	290	72.00	76.00	20,232	22,400	194	185	31.20	33.40	6,053	6,179
Massachusetts.....	165	162	94.00	90.00	15,510	14,580	100	93	36.30	37.30	3,630	3,469
Rhode Island.....	20	21	101.00	90.00	2,020	1,890	13	12	40.10	39.70	521	476
Connecticut.....	114	116	94.00	85.00	10,716	9,860	75	76	41.90	41.00	3,142	3,116
New York.....	1,478	1,508	89.00	85.00	131,542	128,180	911	930	41.00	38.30	37,351	35,619
New Jersey.....	150	150	100.00	90.00	15,000	13,500	74	70	51.30	41.60	3,796	2,912
Pennsylvania.....	979	900	85.00	75.00	83,215	72,000	731	717	40.70	37.80	29,752	26,336
Delaware.....	46	43	76.00	64.00	3,496	2,752	23	23	42.80	35.80	984	823
Maryland.....	177	181	80.00	69.50	14,160	12,580	135	134	45.60	38.90	6,156	5,213
Virginia.....	424	400	69.00	67.00	29,256	22,800	567	530	46.40	37.70	26,309	19,981
West Virginia.....	243	245	71.00	61.50	17,253	15,068	366	373	50.30	44.80	18,410	16,710
North Carolina.....	315	309	69.00	61.00	21,735	15,759	379	375	31.90	24.80	12,090	9,300
South Carolina.....	203	193	78.00	67.50	15,834	11,098	244	232	34.40	25.60	8,394	5,939
Georgia.....	452	435	65.00	61.80	29,380	22,533	763	727	27.30	22.20	20,830	16,139
Florida.....	149	145	61.00	53.00	9,089	7,655	936	891	24.80	22.20	23,213	19,780
Ohio.....	1,030	1,099	83.50	74.00	86,005	74,000	1,102	1,080	47.30	43.70	52,125	47,196
Indiana.....	713	713	85.00	70.00	60,605	49,910	780	757	52.40	45.00	40,872	34,065
Illinois.....	1,060	1,050	90.00	80.50	95,400	84,525	1,367	1,314	54.00	49.70	73,818	65,306
Michigan.....	848	865	83.00	74.00	70,384	64,010	729	752	38.90	35.90	28,358	26,997
Wisconsin.....	1,803	1,785	82.00	75.00	147,846	133,875	1,436	1,394	37.00	33.30	53,132	46,420
Minnesota.....	1,338	1,338	78.00	70.00	106,704	92,960	1,632	1,600	33.50	31.40	54,672	50,240
Iowa.....	1,381	1,405	86.00	76.70	118,766	107,764	2,861	2,919	52.60	47.90	150,489	139,820
Missouri.....	919	910	74.00	69.70	68,006	63,427	1,782	1,782	49.40	47.60	88,031	84,823
North Dakota.....	429	425	80.00	69.00	34,320	29,325	612	630	47.60	41.60	29,131	26,208
South Dakota.....	561	555	82.00	75.00	46,002	41,625	1,496	1,438	53.90	49.80	80,634	71,612
Nebraska.....	662	676	85.00	78.50	56,270	53,066	2,940	2,940	49.90	49.30	146,706	144,942
Kansas.....	964	945	81.00	75.40	78,084	71,253	2,401	2,354	52.70	49.30	126,533	116,052
Kentucky.....	444	435	72.00	61.00	31,968	26,535	599	581	42.50	39.00	25,458	22,659
Tennessee.....	380	373	66.00	55.00	25,080	20,515	587	554	34.30	30.10	20,134	16,675
Alabama.....	494	454	58.00	47.50	28,652	21,565	851	760	24.30	20.40	20,679	15,504
Mississippi.....	549	508	60.00	47.50	32,940	24,130	708	644	26.70	21.90	18,904	14,104
Louisiana.....	363	330	58.00	49.50	21,054	16,335	690	600	26.80	24.20	18,492	14,520
Texas.....	1,060	1,128	63.00	57.50	66,780	64,860	3,961	4,660	36.80	34.40	145,765	160,304
Oklahoma.....	561	567	68.00	67.70	38,148	38,386	1,444	1,430	44.20	43.90	63,825	62,777
Arkansas.....	443	430	59.00	56.00	26,137	24,080	678	640	24.70	24.90	16,747	15,936
Montana.....	197	179	87.00	83.50	17,139	14,946	1,020	1,020	58.90	56.10	60,078	57,222
Wyoming.....	72	65	95.00	88.00	6,840	5,720	1,000	910	61.80	59.10	61,800	53,781
Colorado.....	264	254	88.00	82.00	23,232	20,828	1,361	1,272	54.40	50.20	74,038	63,854
New Mexico.....	84	88	75.00	72.00	6,300	6,336	1,325	1,250	42.90	41.90	56,842	52,375
Arizona.....	72	85	90.00	85.00	6,480	7,225	1,100	1,100	43.40	40.50	47,740	44,550
Utah.....	101	96	82.00	73.50	8,282	7,056	480	457	48.10	43.90	23,088	20,062
Nevada.....	29	28	94.00	85.00	2,726	2,380	533	517	47.00	46.30	25,051	23,937
Idaho.....	139	139	82.00	73.00	11,398	10,147	537	488	48.90	44.70	26,259	21,814
Washington.....	216	240	75.00	70.00	16,200	16,800	307	320	37.60	36.00	11,543	11,520
Oregon.....	222	227	66.00	60.00	14,652	13,620	703	683	44.80	39.50	31,494	26,978
California.....	561	597	79.00	72.50	44,319	43,282	1,650	1,701	48.20	42.10	79,530	71,612
United States..	23,467	23,310	78.24	70.54	1,836,055	1,644,231	44,899	44,112	44.16	40.88	1,960,670	1,803,482

CATTLE—Continued.

TABLE 203.—Cattle: Wholesale price per 100 pounds, 1913–1918.

Date.	Chicago, inferior to prime.			Cincinnati, medium to heavy butcher steers.			St. Louis, good to choice native steers.			Kansas City, common to prime.			Omaha, native beefs.		
	Low.	High.	Average.	Low.	High.	Average.	Low.	High.	Average.	Low.	High.	Average.	Low.	High.	Average.
1913.															
Jan.-June.....	\$5.65	\$9.85	\$7.81	\$4.65	\$7.65	\$5.92	\$8.00	\$9.25	\$9.05	\$4.75	\$9.00	\$7.00	\$9.50	\$8.22
July-Dec.....	5.00	10.25	8.14	4.50	7.00	6.02	8.50	10.00	9.07	4.50	10.00	7.70	9.25	8.64
1914.															
Jan.-June.....	6.60	9.75	8.24	5.35	7.25	6.16	8.65	9.50	9.02	5.20	9.40	6.50	10.50	8.23
July-Dec.....	5.40	11.75	8.99	4.65	7.25	5.27	9.30	11.10	10.24	4.50	11.35	6.00	10.75	9.04
1915.															
Jan.-June.....	5.30	10.15	7.96	4.85	7.00	5.90	7.00	10.00	8.06	6.00	9.75	\$7.51	6.50	9.35	8.05
July-Dec.....	5.75	11.50	8.44	4.00	7.00	5.32	8.60	10.50	9.56	5.50	10.35	8.21	8.90	10.10	9.05
1916.															
Jan.-June.....	6.90	11.50	9.04	5.25	9.50	6.96	6.50	10.50	8.20	6.90	11.50	8.84	7.20	11.00	8.97
July-Dec.....	6.50	13.25	9.43	5.50	9.00	6.79	8.00	11.50	9.59	6.00	12.00	9.51	8.25	11.50	9.88
1917.															
January.....	5.75	11.95	8.97	6.00	10.25	8.12	10.00	10.75	10.38	6.50	11.25	8.90	10.00	11.50	10.80
February.....	6.60	12.25	9.36	6.00	11.25	8.49	10.00	11.00	10.53	6.50	12.00	9.26	10.25	11.50	10.88
March.....	6.25	12.90	9.71	6.50	11.25	8.82	10.25	11.25	10.67	6.50	11.50	8.96	10.25	12.50	11.57
April.....	7.65	13.40	10.71	7.00	11.75	9.37	10.25	11.50	10.81	6.50	12.00	10.00	11.35	13.05	12.27
May.....	8.25	13.70	11.25	7.50	12.50	9.90	10.25	12.25	11.11	9.00	13.40	10.99	11.25	13.35	12.53
June.....	7.90	13.90	10.97	7.50	12.85	10.14	11.00	12.25	11.64	9.00	13.75	11.58	12.25	13.85	13.04
Jan.-June.....	5.75	13.90	10.16	6.00	12.85	9.14	10.00	12.25	10.86	6.50	13.75	9.95	10.00	13.85	11.85
July.....	6.50	14.15	10.58	6.50	12.25	9.38	11.25	13.75	12.11	9.75	13.90	11.65	12.25	14.00	13.09
August.....	6.15	16.50	11.12	6.50	13.00	9.52	11.25	14.00	12.51	9.75	16.00	12.06	12.50	15.55	13.75
September.....	6.25	17.90	12.23	6.50	14.50	9.69	11.75	15.50	13.64	10.00	17.00	15.18	13.00	17.00	14.96
October.....	6.50	17.60	12.06	6.00	14.00	9.88	12.75	15.50	14.36	10.00	16.50	14.85	15.00	16.50	15.82
November.....	6.50	17.60	11.53	6.00	13.35	9.64	10.50	16.50	13.51	10.00	16.50	13.28	14.00	16.75	14.81
December.....	6.65	16.00	11.01	5.00	13.50	9.64	10.00	16.00	12.49	9.25	14.75	12.22	11.50	15.00	13.20
July-Dec.....	6.15	17.90	11.42	5.00	14.50	9.62	10.00	16.50	13.10	9.25	17.00	13.21	11.50	17.00	14.27
1918.															
January.....	8.25	14.25	11.42	6.50	13.00	9.85	11.25	13.50	12.44	7.75	14.00	10.77	10.00	14.00	11.64
February.....	9.03	14.25	11.75	7.00	12.50	9.86	11.25	13.75	12.39	8.00	13.75	10.85	10.00	13.40	11.91
March.....	9.50	14.65	12.19	7.50	13.50	10.38	11.25	14.25	12.56	8.75	14.25	11.22	10.75	14.10	12.51
April.....	11.00	17.60	14.08	8.00	16.00	11.59	10.50	15.75	12.92	8.75	17.50	12.74	12.25	17.40	15.48
May.....	12.00	17.75	15.42	9.00	17.00	12.80	12.00	16.00	14.00	8.50	17.65	13.37	16.50	17.75	17.13
June.....	12.50	18.60	16.67	8.00	17.00	12.56	12.00	16.00	14.00	9.00	18.25	13.52	17.00	18.25	17.47
Jan.-June.....	8.25	18.60	13.59	6.50	17.00	11.17	10.50	16.00	13.05	7.75	18.25	12.08	10.00	18.25	14.36
July.....	16.40	18.65	17.51	7.50	17.00	12.19	11.00	16.75	14.44	13.00	18.50	15.61	15.25	18.40	17.30
August.....	17.00	19.70	18.04	7.50	17.00	12.08	11.00	17.50	14.25	13.00	18.50	15.68	15.00	18.40	16.89
September.....	16.50	19.60	18.34	7.50	16.75	12.12	11.00	17.50	14.25	13.00	19.60	15.96	15.00	19.00	17.15
October.....	15.00	19.75	17.65	6.50	16.75	10.88	11.00	17.50	14.25	13.00	19.25	16.02	15.25	19.00	17.01
November.....	15.25	19.75	17.68	6.00	16.50	10.97	9.00	17.00	13.44	13.00	19.25	16.06	15.25	18.50	16.88
December.....	15.50	20.50	18.18	6.50	16.50	11.50	9.25	20.50	15.01	13.00	19.25	16.21	14.75	18.50	16.74
July-Dec.....	15.00	20.50	17.90	6.00	17.00	11.62	9.00	20.50	14.27	13.00	19.60	15.92	14.75	19.00	17.00

CATTLE—Continued.

TABLE 209.—Beef cattle: Farm price per 100 pounds, 15th of month, 1910–1918.

Date.	1918	1917	1916	1915	1914	1913	1912	1911	1910
Jan. 15.....	\$8.33	\$6.86	\$5.85	\$5.99	\$6.04	\$5.40	\$4.46	\$4.58	\$4.71
Feb. 15.....	8.55	7.36	5.99	5.93	6.16	5.55	4.61	4.57	4.64
Mar. 15.....	8.85	7.91	6.37	5.92	6.28	5.88	4.75	4.66	4.87
Apr. 15.....	9.73	8.57	6.66	5.96	6.29	6.08	5.15	4.67	5.31
May 15.....	10.38	8.70	6.73	6.13	6.33	6.01	5.36	4.59	5.23
June 15.....	10.40	8.65	6.91	6.20	6.32	6.02	5.23	4.43	5.20
July 15.....	10.07	8.30	6.78	6.07	6.38	5.98	5.17	4.28	4.84
Aug. 15.....	9.71	8.17	6.51	6.18	6.47	5.91	5.37	4.39	4.64
Sept. 15.....	9.63	8.40	6.55	6.06	6.38	5.92	5.35	4.43	4.65
Oct. 15.....	9.33	8.35	6.37	6.04	6.23	6.05	5.36	4.32	4.64
Nov. 15.....	9.14	8.21	6.44	5.85	6.02	5.99	5.22	4.36	4.48
Dec. 15.....	9.28	8.24	6.56	5.75	6.01	5.96	5.33	4.37	4.45

TABLE 210.—Milch cows: Farm price per head, 15th of month, 1910–1918.

Date.	1918	1917	1916	1915	1914	1913	1912	1911	1910
Jan. 15.....	\$76.54	\$63.92	\$57.79	\$58.47	\$57.99	\$49.51	\$42.89	\$44.70	\$41.18
Feb. 15.....	78.36	65.93	57.99	57.99	59.09	51.42	43.40	44.48	40.35
Mar. 15.....	80.71	68.46	59.51	58.00	59.73	54.02	44.09	45.42	41.75
Apr. 15.....	82.45	72.09	60.68	57.78	59.60	55.34	45.14	44.81	42.22
May 15.....	84.11	72.78	60.98	58.29	59.85	54.80	45.63	44.54	42.38
June 15.....	84.74	72.87	61.63	58.59	59.82	55.20	45.84	43.86	43.46
July 15.....	84.97	72.81	62.04	60.31	59.67	54.80	45.41	42.44	42.86
Aug. 15.....	84.06	72.53	61.32	60.34	60.72	54.78	46.11	42.26	42.77
Sept. 15.....	85.21	73.93	61.41	58.38	59.58	55.78	46.79	42.22	42.68
Oct. 15.....	85.41	75.79	62.19	58.76	59.53	56.47	47.30	42.69	43.20
Nov. 15.....	84.51	75.00	62.67	57.35	58.77	57.71	47.38	42.70	43.34
Dec. 15.....	85.78	76.16	63.18	56.79	58.23	57.19	48.62	42.72	43.41

TABLE 211.—Veal calves: Farm price per 100 pounds, 15th of month, 1910–1918.

Date.	1918	1917	1916	1915	1914	1913	1912	1911	1910
Jan. 15.....	\$11.16	\$9.15	\$7.67	\$7.66	\$7.89	\$7.06	\$6.06	\$6.50	\$6.41
Feb. 15.....	11.17	9.88	7.87	7.62	7.90	7.23	6.07	6.38	6.28
Mar. 15.....	11.33	9.94	8.11	7.50	7.92	7.49	6.11	6.48	6.59
Apr. 15.....	11.71	10.49	8.00	7.31	7.68	7.38	6.22	5.96	6.54
May 15.....	11.62	10.48	8.08	7.35	7.59	7.17	6.23	5.68	6.30
June 15.....	11.88	10.60	8.39	7.53	7.69	7.53	6.33	5.72	6.57
July 15.....	12.33	10.77	8.54	7.87	7.80	7.46	6.33	5.74	6.37
Aug. 15.....	12.22	10.56	8.59	7.75	8.08	7.53	6.62	5.93	6.29
Sept. 15.....	12.57	11.08	8.77	7.80	8.06	7.73	6.83	6.11	6.43
Oct. 15.....	12.35	11.10	8.59	7.91	7.97	7.72	6.90	6.15	6.41
Nov. 15.....	11.94	10.66	8.60	7.69	7.78	7.70	6.77	6.10	6.39
Dec. 15.....	12.31	10.98	8.79	7.61	7.61	7.74	6.88	5.98	6.38

BUTTER AND EGGS.

TABLE 212.—Butter: Wholesale price per pound, 1913-1918.

Date.	Chicago, creamery, extra.			Cincinnati, creamery, extra.			Milwaukee, creamery, extra.			New York, creamery, extra.			Boston, creamery, extra.		
	Low.	High.	Average.	Low.	High.	Average.	Low.	High.	Average.	Low.	High.	Average.	Low.	High.	Average.
1913.	<i>Cts.</i>	<i>Cts.</i>	<i>Cts.</i>	<i>Cts.</i>	<i>Cts.</i>	<i>Cts.</i>	<i>Cts.</i>	<i>Cts.</i>	<i>Cts.</i>	<i>Cts.</i>	<i>Cts.</i>	<i>Cts.</i>	<i>Cts.</i>	<i>Cts.</i>	<i>Cts.</i>
Jan.-June.....	25	36	31	40	27	35	26½	42	28	36½
July-Dec.....	24	36	30	39½	26	35½	26	37½	27	35
1914.															
Jan.-June.....	24	35½	27½	39½	23½	35½	24½	50	25	34½
July-Dec.....	26	34	30	38	26	34	26½	36½	27½	33½
1915.															
Jan.-June.....	26	34	29½	38	25½	34	24	36	27	33½
July-Dec.....	24	34	28	38	24	34	25	36½	26	32
1916.															
Jan.-June.....	27½	36½	32	40	28	36	29	38	29½	35½
July-Dec.....	27½	42	31½	46	27½	42	28½	42½	29	39
1917.															
January.....	36½	39	40½	43	36½	39	39	42½	38	39
February.....	38	42	43	46	39	42	40½	46	39	40
March.....	40	42½	44	44	40	42	40½	44½	39	41
April.....	37½	46	44	50	38	46	39	46½	43½	47
May.....	37	43	41	45	37	43	38	43½	39½	43
June.....	36	41	39	45	36	42	37½	42	38	41½
Jan.-June..	36	46	39	50	36	46	37½	46½	38	47
July.....	30½	38½	39	40½	38½	42	37½	40	38½	39
August.....	38	41½	40½	43½	38½	42	39½	43½	39½	43
September.....	41½	43½	43½	45½	42	43½	43½	45	43½	45
October.....	42	43½	44½	46	42½	44	43½	46	43½	45
November.....	43	46½	45½	47½	43½	46	44	48	43½	44
December.....	46½	49	47½	53	46	48	47	51½	44½	46
July-Dec...	36½	49	39	53	38½	48	37½	51½	39½	46
1918.															
January.....	48	49	48.7	53	53½	53.1	48	49	48.5	50½	54½	52.2
February.....	46	49½	48.7	53	54	53.5	47½	49	48.9	49½	53½	51.3
March.....	40	46	43.3	45	53	48.9	40	47½	43.7	40½	48½	44.8	42	49	44.7
April.....	40	42½	41.4	44½	46½	45.8	40	41½	41.0	40½	45½	43.2	42	45	43.4
May.....	41	43	42.1	46	47½	46.7	41	42½	41.7	42½	48	47.3	43½	46	45.1
June.....	41	43	42.2	45½	46½	45.9	41	42½	41.9	42½	45	43.8	43½	45	44.1
Jan.-June..	40	49½	44.4	44½	54	49.0	40	49	44.3	40½	54½	47.1	42	49	44.3
July.....	42½	44	41.8	46	47	46.5	42½	43½	43.0	44½	45	44.8	44½	45½	45.1
August.....	43½	46½	47.5	47	48½	47.6	43½	45½	44.3	44½	48	46.0	45½	47½	46.1
September.....	46½	59½	54.4	48½	63	55.7	46½	59	53.6	48	62	55.4	47½	60	54.6
October.....	55	58	58.3	58½	63	59.7	55	58	56.2	57	62	58.8	58	60	59.0
November.....	58	66½	61.6	59½	67½	63.4	57½	64½	60.0	59	68	62.9	59	64	61.3
December.....	66	67½	60.7	67½	71	70.5	64½	65½	64.6	67½	70	69.0	65	67	66.6
July-Dec...	42½	67½	54.0	46	71	57.2	42½	65½	53.6	44½	70	56.2	44½	67	55.4

BUTTER AND EGGS—Continued.

TABLE 213.—Butter: Average price received by farmers on 1st of each month, by States 1918, and United States 1909–1917.

State and year.	Butter, cents per pound.											
	January.	February.	March.	April.	May.	June.	July.	August.	September.	October.	November.	December.
Maine.....	48	45	48	46	47	46	45	48	48	50	55	55
New Hampshire.....	50	51	52	49	48	48	49	49	50	55	60	60
Vermont.....	50	50	51	47	48	47	46	49	50	56	59	61
Massachusetts.....	48	51	52	49	48	48	48	49	50	56	61	63
Rhode Island.....	49	52	51	51	51	52	50	50	56	58	63
Connecticut.....	51	51	53	50	50	49	51	52	52	53	59	60
New York.....	48	50	49	47	46	46	46	46	49	56	58	60
New Jersey.....	51	52	51	49	47	49	49	50	51	55	61	64
Pennsylvania.....	50	50	50	47	46	44	41	45	47	50	56	61
Delaware.....	50	51	50	48	52	50	40	42	52	50	55	60
Maryland.....	44	40	44	43	43	39	38	41	42	48	49	53
Virginia.....	41	45	41	42	40	38	36	37	40	42	43	46
West Virginia.....	42	40	43	43	41	35	34	37	39	41	45	47
North Carolina.....	39	40	40	37	38	37	37	37	38	40	41	43
South Carolina.....	41	45	43	43	43	42	44	44	44	46	46	51
Georgia.....	41	39	40	39	39	38	37	38	39	41	43	47
Florida.....	48	45	48	47	44	42	45	45	48	54	53	52
Ohio.....	43	43	43	40	40	38	36	38	40	47	50	54
Indiana.....	39	39	39	37	36	34	34	35	38	45	46	50
Illinois.....	42	44	43	39	38	37	37	38	41	48	49	53
Michigan.....	44	46	45	41	40	38	39	40	42	50	52	55
Wisconsin.....	47	49	47	43	42	41	42	44	44	55	56	58
Minnesota.....	45	45	47	41	40	40	40	41	42	52	54	58
Iowa.....	43	46	44	41	40	39	40	41	41	51	53	55
Missouri.....	39	39	39	36	36	34	34	34	37	42	42	47
North Dakota.....	42	42	44	39	38	37	34	36	39	43	48	50
South Dakota.....	43	45	44	41	40	40	38	40	41	50	52	56
Nebraska.....	41	41	42	37	36	35	37	38	39	47	51	54
Kansas.....	40	41	41	38	39	36	36	38	40	47	50	52
Kentucky.....	36	36	36	34	32	32	30	32	34	36	37	41
Tennessee.....	35	35	33	33	32	31	31	31	32	33	36	38
Alabama.....	36	37	35	35	34	33	35	33	35	36	38	41
Mississippi.....	36	37	36	35	34	34	32	33	35	38	39	41
Louisiana.....	43	47	42	39	38	37	38	40	41	44	48	48
Texas.....	40	38	39	37	36	36	34	36	37	41	41	44
Oklahoma.....	41	39	38	37	36	34	35	35	36	42	45	49
Arkansas.....	36	38	36	34	35	33	33	33	35	38	39	42
Montana.....	48	45	48	46	43	43	37	42	42	43	50	54
Wyoming.....	51	47	47	43	44	42	38	41	47	51	53	57
Colorado.....	48	45	45	42	41	40	40	40	43	47	55	56
New Mexico.....	48	47	45	48	46	47	48	44	47	49	56	53
Arizona.....	52	48	49	47	52	47	55	47	58	54	66	60
Utah.....	46	46	46	43	41	41	39	42	43	52	52	52
Nevada.....	51	51	54	53	41	49	46	45	51	55	60	65
Idaho.....	49	46	47	46	43	40	39	44	48	52	62	59
Washington.....	50	51	50	48	44	42	44	48	55	56	63	63
Oregon.....	50	51	50	48	42	42	41	46	48	53	61	61
California.....	49	50	51	48	44	44	45	51	51	55	61	61
United States.....	43.1	43.7	43.4	40.7	39.9	38.6	38.2	39.7	41.4	47.2	49.7	52.7
1917.....	34.0	33.5	34.1	33.5	36.1	35.0	33.5	34.0	36.1	38.9	40.9	41.9
1916.....	28.3	27.6	27.1	27.6	27.9	26.5	25.7	26.1	27.4	29.0	31.1	34.4
1915.....	28.7	27.9	26.8	25.8	25.7	24.8	24.2	24.2	24.5	25.3	26.4	27.6
1914.....	29.2	27.4	26.0	24.9	23.8	22.8	22.9	23.7	25.3	26.0	26.3	28.4
1913.....	28.4	27.6	27.5	27.6	27.0	25.5	24.7	24.9	25.9	27.5	28.2	29.2
1912.....	28.1	20.0	27.2	26.1	26.0	24.8	23.4	23.7	24.2	25.6	26.9	28.8
1911.....	27.8	24.1	22.7	22.6	21.4	20.3	20.4	21.7	23.1	23.8	25.2	27.4
1910.....	28.7	27.9	26.3	25.2	25.5	24.1	23.3	23.8	25.2	26.2	27.1	27.8
1909.....	25.1	24.5	24.2	24.0	22.5	21.9	22.4	23.3	25.0	26.2	27.4

BUTTER AND EGGS—Continued.

TABLE 214.—Butter: International trade, calendar years 1909–1917.

[Butter includes all butter made from milk, melted and renovated butter, but does not include margarine, coco butter, or ghee. See "General note," Table 196.]

EXPORTS.
[000 omitted.]

Country.	Average, 1909–1913.	1916 (prelim.)	1917 (prelim.)	Country.	Average, 1909–1913.	1916 (prelim.)	1917 (prelim.)
<i>From—</i>	<i>Pounds.</i>	<i>Pounds.</i>	<i>Pounds.</i>	<i>From—</i>	<i>Pounds.</i>	<i>Pounds.</i>	<i>Pounds.</i>
Argentina.....	6,934	12,502	Italy.....	7,870	792	172
Australia.....	77,859	75,840	Netherlands.....	75,133	78,997
Austria-Hungary...	4,267	New Zealand.....	38,761	40,167
Belgium.....	3,125	Norway.....	3,137	1,027
Canada.....	3,973	7,787	4,345	Russia.....	150,294	22
Denmark.....	195,530	Sweden.....	45,870
Finland.....	26,337	8,960	United States.....	4,125	26,561	7,196
France.....	40,769	21,046	Other countries.....	4,811
Germany.....	498	Total.....	689,293

IMPORTS.

<i>Into—</i>				<i>Into—</i>			
Austria-Hungary...	6,281	France.....	13,713	761
Belgium.....	14,024	Germany.....	111,441
Brazil.....	4,551	140	Netherlands.....	4,987	992
British South Africa	4,234	273	27	Russia.....	2,202	5,922
Canada.....	3,388	2,092	466	Sweden.....	330
Denmark.....	6,241	Switzerland.....	11,106	946	369
Dutch East Indies.	4,152	United Kingdom...	455,489	240,270
Egypt.....	2,350	705	533	Other countries.....	27,364
Finland.....	2,370	3	Total.....	674,223

TABLE 215.—Butter: Receipts at seven leading markets in the United States, 1891–1918.

[From Board of Trade, Chamber of Commerce, and Merchants' Exchange reports; for 1917 and subsequently from Bureau of Markets.]

[000 omitted.]

Year.	Boston.	Chicago.	Mil- waukee.	St. Louis.	San Fran- cisco.	Total 5 cities.	Cincin- nati.	New York.
<i>Averages:</i>	<i>Pounds.</i>	<i>Pounds.</i>	<i>Pounds.</i>	<i>Pounds.</i>	<i>Pounds.</i>	<i>Pounds.</i>	<i>Packages.</i>	<i>Packages.</i>
1891–1895.....	40,955	145,225	3,996	13,944	15,240	219,330	88	1,741
1896–1900.....	50,790	232,289	5,096	14,582	14,476	317,233	157	2,010
1901–1905.....	57,716	245,203	7,164	14,685	15,026	339,794	177	2,122
1906–1910.....	66,612	286,518	8,001	17,903	13,581	392,615	169	2,207
1901.....	57,500	253,809	5,590	13,477	14,972	345,348	238	2,040
1902.....	54,574	219,233	7,290	14,573	14,801	310,471	223	1,933
1903.....	54,347	232,032	6,857	14,080	13,570	320,886	121	2,113
1904.....	55,435	249,024	7,993	15,727	14,336	342,515	147	2,170
1905.....	66,725	271,915	8,091	15,566	17,450	379,747	155	2,355
1906.....	65,152	248,648	8,209	13,198	9,282	344,489	205	2,242
1907.....	63,589	263,715	8,219	13,453	17,339	366,335	187	2,113
1908.....	69,843	316,695	8,798	18,614	13,833	427,783	166	2,175
1909.....	65,054	284,547	7,458	21,086	14,486	392,631	150	2,250
1910.....	69,421	318,986	7,319	23,163	13,994	432,883	135	2,257
1911.....	63,874	334,932	8,632	24,839	21,118	453,395	162	2,405
1912.....	71,609	287,799	6,927	20,399	24,887	411,621	120	2,433
1913.....	71,703	286,220	9,415	24,686	23,027	415,051	102	2,522
1914.....	73,028	311,557	9,716	24,614	22,421	441,336	72	2,505
1915.....	82,082	344,879	8,679	21,264	28,349	485,253	129	2,741
1916.....	79,305	359,195	7,976	16,445	28,029	490,950	151	2,918
1917.....	69,168	323,100	6,116	16,996	25,032	440,412	63	2,575
1918.....	71,440	277,661	5,094	14,164	22,908	391,267	68	2,804
1918.								
January.....	2,345	18,142	478	761	2,278	24,005	3	183
February.....	2,759	22,169	213	711	1,851	27,701	3	188
March.....	4,323	24,051	314	936	2,564	32,188	3	210
April.....	4,071	21,039	335	937	3,129	29,511	1	191
May.....	6,159	20,780	556	1,195	2,771	31,416	2	234
June.....	11,874	36,173	761	1,973	2,170	52,550	6	372
July.....	12,237	34,554	723	1,428	1,762	50,705	2	345
August.....	7,569	27,037	575	1,663	1,531	38,375	1	270
September.....	5,377	21,134	444	944	1,178	29,077	32	208
October.....	6,218	21,916	314	976	1,215	30,639	2	245
November.....	5,079	16,122	191	1,254	1,258	23,905	2	175
December.....	3,429	14,544	190	1,386	1,201	20,750	11	183

BUTTER AND EGGS—Continued.

TABLE 216.—Eggs: Wholesale price per dozen, 1913-1918.

Date.	Chicago, fresh firsts.			Cincinnati. ¹			St. Louis, fresh firsts.			Milwaukee, fresh firsts.			New York, fresh firsts.		
	Low.	High.	Average.	Low.	High.	Average.	Low.	High.	Average.	Low.	High.	Average.	Low.	High.	Average.
1913.	Cts.	Cts.	Cts.	Cts.	Cts.	Cts.	Cts.	Cts.	Cts.	Cts.	Cts.	Cts.	Cts.	Cts.	Cts.
Jan.-June.....	16½	27½	15½	27½	14½	25	14	25	20	40
July-Dec.....	16	37	18½	42	12	35	13	35	25	65
1914.															
Jan.-June.....	17	32½	16½	36	14	31	15	30	20	50
July-Dec.....	18	36	18½	38½	18	35	16	32	24	62
1915.															
Jan.-June.....	16	38	12½	40½	15½	37½	15½	34	18	44
July-Dec.....	16	30½	10	36	14½	30	15½	32	18	40
1916.															
Jan.-June.....	18½	32½	17	34½	17	31	17	31	20½	35
July-Dec.....	21½	41	17½	47	22	39	19	38	23½	47
1917.															
January.....	36½	49	30	53	36	42	33	44	39	53
February.....	29	45	29	50	28	42	29	42	33	49
March.....	26	31	22	31	25½	29½	25½	31	28½	35
April.....	29½	36	27½	34	28½	35	30	35½	32	36½
May.....	31	35½	28	34½	30½	33½	31	35	33½	37½
June.....	28½	35	26	35	27½	33	28	35	30	37½
Jan.-June..	26	49	22	53	25½	44	25½	44	28½	53
July.....	30½	33½	20	35	26	29½	30½	38	34	36
August.....	30½	37½	20	39	26	35	30½	38	34	42
September.....	36	39	30	41	34	37	36½	38	39	42
October.....	36	39	33	50	34	37	36	38	39	43
November.....	38	49	36	50	38	43½	38	45	41	56
December.....	46	57	37	57	42½	51	44	55	51½	62
July-Dec..	30½	57	20	57	26	51	30½	55	34	62
1918.															
January.....	55	62	58.3	44	66	55.7	49½	58	55.1	53	58	55.5	61	70	65.1
February.....	37½	63	51.4	33	65	51.0	38	59	48.8	34	58	50.6	41½	64	58.9
March.....	33	38	34.8	29	35	32.5	31½	35½	33.5	30	36	34.4	34½	41½	38.0
April.....	30	34½	32.7	30	33	31.7	30	32½	31.6	31	34	33.0	31½	36½	34.8
May.....	30	34	31.5	27½	32½	30.1	26	32½	29.9	31	33	32.3	32½	36½	34.8
June.....	29	35	32.0	26	37	30.9	26½	34	28.9	30	35	32.0	33	38	35.2
Jan.-June..	29	63	40.1	26	66	38.6	26	59	38.0	30	58	47.4	31½	70	44.5
July.....	34	39½	37.6	33	37½	35.0	30	36½	33.6	34	39½	37.5	36	43	41.0
August.....	37	40	38.1	33	42	36.2	32	36	35.7	37	39	38.1	39	47	44.4
September.....	39	48½	43.4	37	46	42.1	36	44	40.9	38	46	42.4	45	52	46.5
October.....	47	54	49.6	42	56	47.6	44	51	46.6	45	50	47.0	52	57	53.0
November.....	55	64½	60.7	51	65	58.2	51	63	56.9	49	63	55.5	55	70	64.0
December.....	58	65	60.3	50	65	59.4	57	62½	60.1	58	63	60.4	61½	72	67.4
July-Dec..	34	65	48.3	33	65	46.4	30	63	45.6	34	63	46.8	36	72	52.7

¹ 1918, fresh firsts; previous years include seconds.

BUTTER AND EGGS—Continued.

TABLE 217.—Eggs: Average price received by farmers on 1st of each month, by States 1918, and United States 1909–1918.

State and year.	Eggs, cents per dozen.											
	January.	February.	March.	April.	May.	June.	July.	August.	September.	October.	November.	December.
Maine.....	58	60	52	40	40	39	42	46	50	55	64	72
New Hampshire.....	65	65	54	40	40	41	45	48	55	62	68	72
Vermont.....	55	52	53	39	37	37	39	46	48	53	62	70
Massachusetts.....	70	66	65	45	45	47	49	58	63	67	75	75
Rhode Island.....	70	62	68	45	42	43	47	67	65	75	80
Connecticut.....	62	64	60	38	42	44	50	59	60	63	75	81
New York.....	57	59	54	39	36	38	42	46	51	54	65	67
New Jersey.....	64	62	57	42	41	42	47	50	55	60	70	74
Pennsylvania.....	54	55	49	34	34	34	36	42	44	48	56	64
Delaware.....	55	61	54	32	33	35	35	38	51	50	60	65
Maryland.....	51	57	40	32	33	31	33	39	39	45	56	62
Virginia.....	47	55	40	31	31	31	32	34	38	43	47	54
West Virginia.....	47	51	44	31	32	31	33	37	39	41	47	53
North Carolina.....	42	48	33	28	29	29	31	32	33	40	43	48
South Carolina.....	45	47	37	33	33	32	34	35	39	42	44	50
Georgia.....	44	44	31	30	30	32	31	32	35	40	43	50
Florida.....	50	45	39	35	33	31	34	36	40	48	51	54
Ohio.....	48	54	42	32	32	31	33	37	37	43	50	59
Indiana.....	47	51	37	31	31	29	30	34	35	41	47	57
Illinois.....	46	51	39	30	30	25	29	33	34	40	46	56
Michigan.....	45	49	47	34	32	31	33	37	38	43	47	55
Wisconsin.....	42	45	43	31	30	30	30	36	37	42	44	51
Minnesota.....	41	44	40	30	30	30	29	32	35	38	42	50
Iowa.....	42	47	38	30	31	28	28	33	33	39	42	51
Missouri.....	43	47	35	30	29	26	26	30	30	37	43	53
North Dakota.....	43	40	43	30	29	28	28	30	33	36	40	44
South Dakota.....	40	42	40	30	29	29	27	31	32	35	39	47
Nebraska.....	39	44	38	29	29	27	25	29	30	36	40	49
Kansas.....	42	45	35	30	29	26	26	30	30	37	42	52
Kentucky.....	44	50	33	28	28	27	26	30	31	36	42	49
Tennessee.....	44	50	32	27	27	26	26	29	31	36	40	52
Alabama.....	39	40	31	26	28	27	27	28	33	37	40	46
Mississippi.....	41	43	37	28	28	27	25	27	33	36	38	45
Louisiana.....	43	49	35	28	29	28	28	30	33	38	42	48
Texas.....	44	43	34	27	27	27	26	27	30	35	40	46
Oklahoma.....	44	45	34	28	28	26	25	27	28	33	40	49
Arkansas.....	41	44	36	26	26	27	23	24	28	33	38	45
Montana.....	55	54	52	37	30	32	32	38	40	41	49	55
Wyoming.....	55	53	55	36	34	34	33	36	44	49	49	57
Colorado.....	49	47	45	30	31	31	30	33	40	43	50	55
New Mexico.....	47	44	36	35	32	35	38	37	40	42	47	53
Arizona.....	65	48	54	34	43	39	45	42	56	58	62	60
Utah.....	46	43	40	29	28	28	28	31	37	42	50	51
Nevada.....	56	53	46	36	38	39	43	42	47	60	60	73
Idaho.....	51	45	43	31	30	30	34	34	39	40	50	55
Washington.....	52	49	43	34	32	34	39	40	48	53	59	66
Oregon.....	55	45	42	35	32	32	35	39	41	48	55	60
California.....	52	49	39	32	33	36	38	43	48	54	63	68
United States.....	46.3	49.4	40.4	31.2	31.0	29.8	30.7	34.4	36.4	41.6	47.2	55.0
1917.....	37.7	35.8	33.8	25.9	30.0	31.1	28.3	29.8	33.2	37.4	39.4	43.3
1916.....	30.6	26.8	21.2	17.9	18.1	19.0	19.7	20.7	23.3	28.1	32.2	38.1
1915.....	31.6	29.2	21.3	16.6	17.1	16.6	16.8	17.0	18.7	22.3	26.3	30.6
1914.....	30.7	28.4	24.2	17.6	16.8	17.3	17.6	18.2	21.0	23.5	25.3	29.7
1913.....	26.8	22.8	19.4	16.4	16.1	16.9	17.0	17.2	19.5	23.4	27.4	33.0
1912.....	29.5	29.1	24.5	17.8	17.1	16.7	16.7	17.4	19.1	22.0	25.9	29.7
1911.....	30.4	22.1	16.5	14.9	14.7	14.5	14.2	15.5	17.4	20.0	23.5	28.7
1910.....	30.5	28.9	22.9	18.6	18.6	18.3	18.2	17.6	19.4	22.4	25.3	29.0
1909.....	25.8	20.1	16.8	17.8	18.4	18.5	19.2	20.2	22.1	24.8	28.4

BUTTER AND EGGS—Continued.

TABLE 218.—Eggs: Receipts at seven leading markets in the United States, 1891-1918. [From Board of Trade, Chamber of Commerce, and Merchants' Exchange reports; for 1917 and subsequently from Bureau of Markets.]

Year.	Boston.	Chicago.	Cincinnati.	Milwaukee.	New York.	St. Louis.	San Francisco.	Total.
Averages:	<i>Cases.</i>	<i>Cases.</i>	<i>Cases.</i>	<i>Cases.</i>	<i>Cases.</i>	<i>Cases.</i>	<i>Cases.</i>	<i>Cases.</i>
1891-1895.....	722,363	1,879,065	288,548	90,943	2,113,946	557,320	166,059	5,818,244
1896-1900.....	912,807	2,196,631	362,262	113,327	2,664,074	852,457	194,087	7,295,645
1901-1905.....	1,155,340	2,960,675	418,842	139,718	3,057,298	1,000,955	304,933	9,067,741
1906-1910.....	1,517,995	4,467,040	509,017	180,362	4,046,360	1,304,719	334,766	12,360,259
1901.....	1,040,555	2,783,709	493,218	128,179	2,909,194	1,022,646	277,500	8,655,001
1902.....	1,053,165	2,659,340	464,799	114,732	2,743,642	825,999	285,058	8,146,735
1903.....	1,164,777	3,279,248	338,327	129,278	2,940,091	959,648	335,228	9,146,597
1904.....	1,122,819	3,113,858	377,263	166,409	3,215,924	1,216,124	319,637	9,532,034
1905.....	1,395,385	3,117,221	420,604	159,990	3,477,638	980,257	307,243	9,858,338
1906.....	1,709,531	3,583,878	484,208	187,561	3,981,013	1,023,125	137,074	11,106,390
1907.....	1,594,576	4,780,356	588,636	176,826	4,262,153	1,288,977	379,439	13,070,963
1908.....	1,436,786	4,569,014	441,072	207,553	3,703,990	1,439,868	347,436	12,145,724
1909.....	1,417,397	4,557,906	519,652	160,418	3,903,867	1,395,987	340,185	12,295,412
1910.....	1,431,686	4,844,045	511,519	179,448	4,380,777	1,375,638	469,698	13,192,811
1911.....	1,441,768	4,707,335	605,131	175,270	5,021,757	1,736,915	587,687	14,275,863
1912.....	1,580,106	4,556,643	668,942	136,896	4,723,520	1,594,534	638,890	13,699,531
1913.....	1,589,400	4,593,800	594,954	191,059	4,713,555	1,398,065	573,042	13,653,875
1914.....	1,531,329	4,083,163	461,927	224,797	4,882,222	1,474,212	619,500	13,277,150
1915.....	1,757,594	4,896,246	812,371	192,743	5,585,329	1,492,729	628,577	15,366,589
1916.....	1,649,828	5,452,737	853,910	208,924	4,858,274	1,521,506	575,014	15,120,193
1917.....	1,501,956	5,678,679	184,022	134,625	4,357,061	1,373,120	715,768	13,945,231
1918.....	1,604,289	5,049,743	176,733	180,616	5,026,548	934,668	666,845	13,639,442
1918.								
January.....	30,909	107,544	8,309	3,965	106,238	9,964	52,870	319,799
February.....	58,774	29,310	7,565	874	155,381	40,536	80,724	373,164
March.....	191,886	414,719	6,341	7,214	711,930	180,270	80,389	1,592,749
April.....	309,301	1,027,342	18,400	26,831	907,509	186,299	93,169	2,568,851
May.....	305,419	926,272	26,445	38,432	680,609	161,131	83,041	2,221,349
June.....	170,991	732,784	17,446	25,479	550,538	106,047	70,744	1,674,029
July.....	133,264	563,717	6,316	16,721	483,359	102,434	50,506	1,356,317
August.....	118,994	459,970	2,980	20,064	449,849	61,731	39,328	1,152,916
September.....	91,036	337,553	22,736	14,618	332,971	30,395	34,174	863,483
October.....	95,529	240,310	50,201	10,742	288,040	24,254	27,159	736,235
November.....	45,912	124,339	3,548	6,222	183,285	17,433	25,752	406,941
December.....	52,274	85,883	6,446	9,454	176,839	14,174	28,989	374,059

CHEESE.

TABLE 219.—Cheese: International trade, calendar years 1909-1917.

[Cheese includes all cheese made from milk; "cottage cheese," of course, is included. See "General note," Table 196.]

EXPORTS.

[000 omitted.]

Country.	Average, 1909-1913.	1916 (Prelim.)	1917 (Prelim.)	Country.	Average, 1909-1913.	1916 (Prelim.)	1917 (Prelim.)
<i>From—</i>	<i>Pounds.</i>	<i>Pounds.</i>	<i>Pounds.</i>	<i>From—</i>	<i>Pounds.</i>	<i>Pounds.</i>	<i>Pounds.</i>
Bulgaria.....	5,584	Russia.....	7,011	105
Canada.....	167,260	170,248	176,380	Switzerland.....	70,075	47,215
France.....	26,880	13,934	United States.....	5,142	54,093	53,510
Germany.....	1,967	Other countries.....	10,705
Italy.....	60,560	39,323	4,337	Total.....	538,124
Netherlands.....	127,379	199,108				
New Zealand.....	55,561	106,335				

IMPORTS.

<i>Into—</i>				<i>Into—</i>			
Algeria.....	6,592	France.....	49,056	24,140
Argentina.....	10,447	3,133	Germany.....	48,687
Australia.....	360	86	Italy.....	13,308	252	9
Austria-Hungary.....	12,298	Russia.....	3,911
Belgium.....	31,771	Spain.....	5,032	1,465	411
Brazil.....	4,178	1,423	Switzerland.....	7,150	427	214
British South Africa.....	5,006	2,037	514	United Kingdom.....	257,407	287,115
Cuba.....	4,520	United States.....	46,346	28,516	6,333
Denmark.....	1,414	Other countries.....	19,590
Egypt.....	8,182	1,865	148	Total.....	535,255

CHICKENS.

TABLE 220.—Chickens: Average price received by farmers on 1st of each month, by States 1918, and United States 1909-1917.

State and year.	Chickens, cents per pound.											
	January.	February.	March.	April.	May.	June.	July.	August.	September.	October.	November.	December.
Maine.....	21.2	21.0	25.3	24.8	24.4	24.1	25.3	29.1	29.4	28.1	30.3	31.0
New Hampshire.....	23.3	25.0	24.5	25.0	23.3	28.3	27.0	28.0	29.4	30.0	32.4	30.4
Vermont.....	22.1	21.7	23.4	23.4	24.5	24.5	24.0	25.1	27.0	28.8	27.4	30.0
Massachusetts.....	25.2	25.8	26.7	27.1	31.0	31.0	33.0	34.9	35.0	35.3	33.0	34.3
Rhode Island.....	25.0	29.0	30.0	31.0	35.0	30.0	33.0	40.0	36.3	37.5	33.0
Connecticut.....	25.4	25.3	26.5	24.5	29.0	29.0	34.2	33.2	34.8	33.0	34.0	35.0
New York.....	22.7	23.2	24.3	26.4	27.3	25.8	27.5	29.5	30.5	30.0	30.1	29.5
New Jersey.....	24.2	25.2	28.4	29.4	29.5	30.6	31.2	32.5	31.6	32.7	36.8	31.8
Pennsylvania.....	20.9	21.3	23.1	22.6	23.0	24.0	24.7	26.9	27.1	27.9	27.5	27.9
Delaware.....	22.0	24.0	29.3	30.0	28.3	27.0	26.5	30.0	28.0	30.0	35.0	29.5
Maryland.....	21.9	23.0	25.4	27.6	26.3	27.0	29.8	29.0	29.0	31.3	29.4	26.5
Virginia.....	20.2	23.5	23.6	25.6	24.1	26.2	28.9	28.3	29.4	30.3	30.1	27.5
West Virginia.....	18.9	19.4	21.2	20.9	21.1	19.3	23.3	25.3	25.6	24.7	24.5	24.0
North Carolina.....	18.2	18.9	18.8	18.7	20.0	21.7	25.0	22.7	22.7	24.3	22.9	23.7
South Carolina.....	20.6	20.3	19.9	19.4	20.2	19.5	21.9	23.4	23.4	26.2	24.7	27.0
Georgia.....	20.6	22.0	20.9	19.8	18.9	21.0	22.3	22.1	23.9	23.2	23.1	24.4
Florida.....	24.4	22.5	23.8	22.0	21.1	24.0	23.6	25.0	26.0	28.6	29.5	27.5
Ohio.....	19.0	19.6	20.8	21.3	21.9	21.0	22.5	24.3	23.5	24.5	22.5	21.6
Indiana.....	17.8	19.0	19.3	19.2	19.4	19.3	20.1	22.2	22.8	23.2	21.7	20.1
Illinois.....	17.1	19.2	20.6	20.0	19.6	19.3	20.4	22.4	22.7	22.3	20.9	20.5
Michigan.....	17.3	19.0	20.0	19.9	20.7	20.7	21.0	22.8	22.6	24.0	22.2	20.8
Wisconsin.....	16.5	17.0	18.4	18.9	19.8	18.9	19.3	19.9	21.9	21.8	21.0	19.2
Minnesota.....	15.1	15.8	15.9	15.5	16.1	17.0	17.1	18.9	19.3	19.3	18.1	18.0
Iowa.....	15.8	17.6	18.5	18.5	18.7	17.9	18.4	20.3	21.2	21.9	20.7	18.8
Missouri.....	16.5	18.2	19.7	19.0	18.2	19.0	20.3	21.5	21.9	20.8	19.9	19.0
North Dakota.....	14.1	11.8	13.5	13.0	14.2	14.4	14.4	13.9	15.0	16.4	16.0	15.0
South Dakota.....	13.5	14.5	15.7	15.2	15.9	15.2	16.3	17.4	16.6	17.7	15.9	17.2
Nebraska.....	15.2	16.2	18.1	17.7	17.8	17.8	18.5	20.9	19.7	18.9	19.1	18.0
Kansas.....	16.5	17.6	18.0	18.0	17.6	17.9	19.0	19.8	20.2	20.3	19.2	18.6
Kentucky.....	17.1	18.0	19.2	18.2	17.8	19.0	20.7	22.4	21.1	21.5	21.2	19.9
Tennessee.....	16.8	17.9	18.3	18.1	16.9	19.2	20.9	21.4	20.5	21.4	20.4	19.6
Alabama.....	18.2	19.0	19.4	17.8	18.5	19.5	20.6	23.7	22.2	21.8	23.2	22.8
Mississippi.....	17.1	18.0	18.2	18.5	17.7	20.0	21.0	20.6	22.1	22.2	21.2	21.4
Louisiana.....	22.3	23.0	21.0	19.2	21.0	20.3	22.4	22.9	23.0	23.2	25.9	24.6
Texas.....	15.8	16.0	17.8	17.6	16.9	16.6	19.0	19.6	19.5	20.6	19.6	20.3
Oklahoma.....	16.1	16.5	18.5	16.2	17.4	17.9	18.1	19.8	19.6	19.1	19.1	18.5
Arkansas.....	15.8	16.5	17.2	16.6	17.1	16.9	18.3	18.6	17.4	17.3	18.2	18.5
Montana.....	18.0	17.4	19.3	20.4	19.6	21.1	19.1	22.0	19.0	19.9	21.9	20.0
Wyoming.....	19.0	18.1	21.3	17.0	18.0	17.6	19.6	21.2	22.0	25.0	22.4	22.0
Colorado.....	18.0	17.0	19.2	18.4	18.4	21.0	18.5	21.3	21.5	21.6	21.6	21.0
New Mexico.....	18.5	15.3	19.9	18.9	18.4	26.0	27.1	27.9	30.0	30.7	21.2	21.3
Arizona.....	24.0	19.3	22.3	21.8	23.5	24.0	25.5	25.0	26.0	27.5	27.7	26.5
Utah.....	18.1	19.6	17.0	18.7	20.1	18.8	19.2	21.5	20.0	19.7	23.1	21.5
Nevada.....	25.0	26.0	24.0	25.6	32.5	27.0	28.8	30.3	29.7	33.3	32.0	32.0
Idaho.....	16.3	16.2	16.3	16.7	16.6	16.6	17.7	18.1	17.2	17.0	19.3	18.0
Washington.....	18.5	18.5	20.6	21.3	21.9	22.8	23.3	21.6	24.3	23.7	24.6	25.0
Oregon.....	17.2	17.8	20.0	21.8	21.7	22.3	19.8	22.6	21.0	22.4	21.5	23.4
California.....	21.4	20.1	23.7	22.8	21.8	22.6	25.1	26.9	25.2	27.4	27.8	29.5
United States.....	17.9	18.8	19.9	19.8	19.8	20.0	21.2	22.6	22.8	23.1	22.4	21.8
1917.....	13.9	14.7	15.5	16.1	17.5	17.5	17.3	17.1	17.2	18.1	17.7	17.5
1916.....	11.4	11.9	12.2	12.6	13.2	13.5	13.8	13.8	13.9	14.3	14.3	14.2
1915.....	11.2	11.5	11.7	11.9	12.1	12.2	12.2	12.2	12.1	12.0	11.8	11.5
1914.....	11.5	11.7	12.1	12.3	12.5	12.5	12.7	12.8	12.7	12.5	11.9	11.3
1913.....	10.7	10.9	11.1	11.6	11.8	12.0	12.1	12.4	12.4	12.5	12.1	11.5
1912.....	9.8	10.3	10.5	10.8	11.1	11.1	11.0	11.3	11.3	11.5	11.2	10.8
1911.....	10.5	10.6	10.6	10.8	11.0	11.0	11.2	11.2	11.1	10.9	10.3	9.6
1910.....	10.9	11.1	11.6	11.9	12.4	12.4	12.3	12.2	11.9	11.6	11.3	10.6
1909.....	9.9	10.0	10.2	10.6	10.9	11.1	11.2	11.1	11.3	10.9	10.8

SHEEP AND WOOL.

TABLE 221.—*Sheep: Number and value on farms in the United States, 1867-1919.*

NOTE.—Figures in *italics* are census returns; figures in roman are estimates of the Department of Agriculture. Estimates of numbers are obtained by applying estimated percentages of increase or decrease to the published numbers of the preceding year, except that a revised base is used for applying percentage estimates whenever new census data are available. It should also be observed that the census of 1910, giving numbers as of Apr. 15, is not strictly comparable with former censuses, which related to numbers June 1.

Jan. 1—	Number.	Price per head Jan. 1.	Farm value Jan. 1.	Jan. 1—	Number.	Price per head Jan. 1.	Farm value Jan. 1.
1867.....	39,385,000	\$2.50	\$98,644,000	1893.....	47,274,000	\$2.66	\$125,909,000
1868.....	38,992,000	1.82	71,053,000	1894.....	45,048,000	1.98	89,186,000
1869.....	37,724,000	1.64	62,037,000	1895.....	42,294,000	1.58	66,686,000
1870.....	40,853,000	1.96	79,876,000	1896.....	38,299,000	1.70	65,168,000
1870, census, June 1.....	<i>28,477,951</i>			1897.....	36,819,000	1.82	67,021,000
1871.....	31,851,000	2.14	68,310,000	1898.....	37,657,000	2.46	92,721,000
1872.....	31,679,000	2.61	82,768,000	1899.....	39,114,000	2.75	107,698,000
1873.....	33,002,000	2.71	89,427,000	1900.....	41,883,000	2.93	122,666,000
1874.....	33,938,000	2.43	82,353,000	1900, census, June 1.....	<i>61,508,713</i>		
1875.....	33,784,000	2.55	86,278,000	1901 ¹	59,757,000	2.98	178,072,000
1876.....	35,935,000	2.37	85,121,000	1902.....	62,039,000	2.65	164,446,000
1877.....	35,804,000	2.13	76,362,000	1903.....	63,965,000	2.63	168,316,000
1878.....	35,740,000	2.21	78,898,000	1904.....	51,630,000	2.59	133,530,000
1879.....	38,124,000	2.07	78,865,000	1905.....	45,170,000	2.82	127,332,000
1880.....	40,766,000	2.21	90,231,000	1906.....	50,632,000	3.54	179,056,000
1880, census, June 1.....	<i>55,192,074</i>			1907.....	53,240,000	3.84	204,210,000
1881.....	43,570,000	2.39	104,071,000	1908.....	54,631,000	3.88	211,736,000
1882.....	45,016,000	2.37	106,596,000	1909.....	56,084,000	3.43	192,632,000
1883.....	49,237,000	2.53	124,366,000	1910.....	57,216,000		
1884.....	50,627,000	2.37	119,903,000	1910, census, Apr. 15.....	<i>52,447,861</i>	4.12	216,030,000
1885.....	50,360,000	2.14	107,961,000	1911 ¹	53,633,000	3.91	209,535,000
1886.....	48,322,000	1.91	92,444,000	1912.....	52,362,000	3.46	181,170,000
1887.....	44,759,000	2.01	89,873,000	1913.....	51,482,000	3.94	202,779,000
1888.....	43,545,000	2.05	89,280,000	1914.....	49,719,000	4.02	200,945,000
1889.....	42,599,000	2.13	90,640,000	1915.....	49,956,000	4.50	224,687,000
1890.....	44,336,000	2.27	100,660,000	1916.....	48,625,000	5.17	251,594,000
1890, census, June 1.....	<i>55,935,364</i>			1917.....	47,616,000	7.13	339,529,000
1891.....	43,431,000	2.50	108,397,000	1918.....	48,603,000	11.82	574,575,000
1892.....	44,938,000	2.58	116,121,000	1919.....	49,863,000	11.61	579,016,000

¹ Estimates of numbers revised, based on census data.

TABLE 222.—*Sheep: Number and value on farms, Jan. 1, 1918 and 1919, by States.*

State.	Number (thousands) Jan. 1—		Average price per head Jan. 1—		Farm value (thousands of dollars) Jan. 1—	
	1919	1918	1919	1918	1919	1918
Maine.....	173	163	\$11.10	\$9.40	1,920	1,532
New Hampshire.....	39	37	12.00	10.60	468	392
Vermont.....	107	104	12.70	11.60	1,359	1,206
Massachusetts.....	28	26	12.50	10.30	350	268
Rhode Island.....	7	6	12.50	9.50	88	57
Connecticut.....	24	20	13.30	11.40	319	228
New York.....	840	800	13.90	13.20	11,676	10,560
New Jersey.....	29	28	13.20	10.90	383	305
Pennsylvania.....	959	913	11.70	11.70	11,220	10,682
Delaware.....	10	10	10.30	9.00	103	90
Maryland.....	246	234	11.30	9.80	2,780	2,293
Virginia.....	713	692	12.50	10.50	8,912	7,266
West Virginia.....	789	751	11.70	11.20	9,231	8,411
North Carolina.....	138	137	8.70	6.60	1,201	904
South Carolina.....	29	30	6.50	4.60	188	138
Georgia.....	144	144	5.80	4.20	835	605
Florida.....	120	120	4.10	3.40	492	408
Ohio.....	2,980	2,950	11.00	11.60	32,780	34,220
Indiana.....	1,093	998	13.90	12.80	15,262	12,774
Illinois.....	1,028	952	14.20	12.90	14,598	12,281

SHEEP AND WOOL—Continued.

TABLE 222.—*Sheep: Number and value on farms, Jan. 1, 1918 and 1919, by States—Continued.*

State.	Number (thousands) Jan. 1—		Average price per head Jan. 1—		Farm value (thousands of dollars) Jan. 1—	
	1919	1918	1919	1918	1919	1918
Michigan.....	2,119	1,926	\$12.50	\$12.60	26,488	24,268
Wisconsin.....	716	651	12.40	11.90	8,878	7,747
Minnesota.....	642	568	13.20	11.80	8,474	6,702
Iowa.....	1,322	1,224	13.70	13.80	18,111	16,891
Missouri.....	1,539	1,466	13.20	12.90	20,315	18,911
North Dakota.....	265	252	12.60	11.80	3,339	2,974
South Dakota.....	810	750	12.20	11.60	9,882	8,700
Nebraska.....	367	408	11.90	11.00	4,367	4,488
Kansas.....	460	418	12.80	12.00	5,888	5,016
Kentucky.....	1,274	1,213	13.10	11.20	16,689	13,586
Tennessee.....	567	550	11.80	8.60	6,691	4,730
Alabama.....	140	131	6.40	4.50	896	590
Mississippi.....	183	174	6.60	4.50	1,208	783
Louisiana.....	230	209	5.20	4.10	1,196	857
Texas.....	2,232	2,188	9.40	7.50	20,981	16,410
Oklahoma.....	125	114	11.80	11.30	1,475	1,288
Arkansas.....	147	134	8.20	7.10	1,205	951
Montana.....	2,984	3,045	11.80	12.60	35,211	38,367
Wyoming.....	4,018	4,100	12.30	13.60	49,421	55,760
Colorado.....	2,303	2,350	10.90	12.60	25,103	29,610
New Mexico.....	3,135	3,135	8.50	10.00	26,648	31,350
Arizona.....	1,400	1,550	10.00	10.40	14,000	16,120
Utah.....	2,410	2,340	11.00	13.60	26,510	31,824
Nevada.....	1,520	1,505	11.80	13.90	17,936	20,920
Idaho.....	3,234	3,202	12.20	13.30	39,455	42,587
Washington.....	780	661	11.80	11.40	9,204	7,535
Oregon.....	2,497	2,448	12.00	12.10	29,964	29,621
California.....	2,943	2,776	12.00	11.30	35,316	31,369
United States.....	49,863	48,603	11.61	11.82	579,016	574,575

TABLE 223.—*Sheep: Imports, exports, and prices, 1893-1918.*

Year ending June 30—	Imports.			Exports.		
	Number.	Value.	Average import price.	Number.	Value.	Average export price.
1893.....	459,484	\$1,682,977	\$3.66	37,260	\$126,394	\$3.39
1894.....	242,568	788,181	3.25	132,370	832,763	6.29
1895.....	291,461	682,618	2.34	405,748	2,630,686	6.48
1896.....	322,692	853,530	2.65	491,565	3,076,384	6.26
1897.....	405,633	1,019,668	2.51	244,120	1,531,645	6.27
1898.....	392,314	1,106,322	2.82	199,690	1,213,886	6.08
1899.....	345,911	1,200,081	3.47	143,286	853,555	5.96
1900.....	381,792	1,365,026	3.58	125,772	733,477	5.83
1901.....	331,488	1,236,277	3.73	297,925	1,933,000	6.49
1902.....	266,953	956,710	3.58	358,720	1,940,060	5.41
1903.....	301,623	1,036,934	3.44	176,961	1,067,860	6.03
1904.....	238,094	815,289	3.42	301,313	1,954,604	6.49
1905.....	186,942	704,721	3.77	268,365	1,687,321	6.29
1906.....	240,747	1,020,359	4.24	142,690	804,090	5.64
1907.....	224,798	1,120,425	4.98	135,344	750,242	5.54
1908.....	224,765	1,082,606	4.82	101,000	589,285	5.83
1909.....	102,663	502,640	4.90	67,656	365,155	5.40
1910.....	126,152	696,879	5.52	44,517	209,000	4.69
1911.....	53,455	377,625	7.06	121,491	636,272	5.24
1912.....	23,588	157,257	6.67	157,263	626,985	3.99
1913.....	15,428	90,021	5.83	187,132	605,725	3.24
1914.....	223,719	532,404	2.38	152,600	534,543	3.50
1915.....	153,317	533,967	3.48	47,213	182,278	3.86
1916.....	235,659	917,502	3.89	52,778	231,535	4.43
1917.....	160,422	856,645	5.34	58,811	367,935	6.26
1918.....	177,681	1,979,746	11.14	7,959	97,028	12.19

SHEEP AND WOOL—Continued.

TABLE 224.—*Sheep: Wholesale price per 100 pounds, 1913-1918.*

Date.	Chicago, native.			Cincinnati, good to extra.			St. Louis, good to choice natives.			Kansas City, native.			Omaha, western.		
	Low.	High.	Average.	Low.	High.	Average.	Low.	High.	Average.	Low.	High.	Average.	Low.	High.	Average.
1913.															
Jan.-June.....	3.00	8.60	6.28	3.75	7.00	4.90	4.75	7.25	5.87	4.85	7.85	6.52	3.75	8.25	6.05
July-Dec.....	2.25	7.25	4.94	3.25	4.65	4.06	4.00	5.00	4.42	3.50	6.65	4.79	2.75	7.00	4.50
1914.															
Jan.-June.....	4.00	7.75	5.96	4.10	6.15	5.03	5.00	6.50	5.82	4.25	7.25	6.00	4.25	7.50	6.41
July-Dec.....	4.25	8.10	6.08	4.00	5.25	4.81	4.50	5.75	5.20	3.40	7.00	5.52	4.25	8.00	5.65
1915.															
Jan.-June.....	2.50	10.65	6.08	4.00	8.75	5.70	5.00	8.50	6.78	4.50	10.00	7.04	4.00	9.75	7.09
July-Dec.....	2.00	8.75	5.18	4.50	8.75	5.38	5.25	6.00	5.55	4.00	8.25	6.09	4.00	8.00	5.71
1916.															
Jan.-June.....	4.25	10.90	7.71	3.75	8.75	6.90	6.50	8.85	7.96	5.00	11.50	8.40	4.50	11.00	8.13
July-Dec.....	3.00	10.25	5.80	5.25	8.50	5.33	7.25	9.00	7.44	6.00	11.75	7.96	5.50	11.75	7.46
1917.															
January.....	7.00	13.50	10.36	7.50	8.40	7.96	9.00	10.25	9.69	7.75	12.50	10.04	7.50	13.00	10.15
February.....	9.00	13.85	11.51	8.00	9.00	8.44	10.50	11.25	10.88	7.75	13.50	11.52	8.75	13.50	11.33
March.....	8.50	14.35	11.53	9.00	11.00	9.80	11.50	12.00	11.80	10.00	13.50	11.36	10.00	13.75	11.63
April.....	8.50	15.50	12.02	10.00	11.75	11.03	12.00	12.00	12.00	10.00	15.00	12.40	10.00	14.50	12.18
May.....	11.75	19.00	14.79	8.50	12.00	10.34	13.50	14.00	13.75	12.00	18.00	14.52	11.50	16.00	13.79
June.....	8.00	17.50	11.54	7.50	9.50	8.62	9.75	13.50	10.80	9.00	12.50	10.42	10.00	13.75	11.49
Jan.-June.....	7.00	19.00	11.96	7.50	12.00	9.36	9.00	14.00	11.49	7.75	18.00	11.71	7.50	16.00	11.76
July.....	7.75	14.00	10.56	6.50	8.25	7.69	8.50	9.25	8.69	8.00	11.25	9.01	8.00	13.75	10.29
August.....	7.75	13.50	10.49	7.50	9.00	8.15	8.50	9.50	9.00	8.00	15.00	9.76	9.00	12.50	10.66
September.....	8.90	14.25	11.46	9.00	10.00	9.59	10.00	11.00	10.50	9.00	15.50	11.97	10.50	13.85	12.09
October.....	9.00	14.35	11.79	9.50	10.50	9.94	11.00	11.50	11.31	9.50	14.75	11.88	9.50	13.75	11.75
November.....	9.00	14.65	11.68	9.50	10.00	9.75	11.00	12.00	11.75	10.00	14.10	12.00	10.50	14.25	11.99
December.....	9.00	14.75	11.61	9.50	10.50	10.00	11.00	11.50	11.40	10.00	14.75	12.19	10.50	14.25	12.38
July-Dec.....	7.75	14.75	11.26	6.50	10.50	9.19	8.50	12.00	10.44	8.00	15.50	11.14	8.00	14.25	11.53
1918.															
January.....	7.50	15.50	11.61	9.00	11.00	10.25	10.00	14.25	11.79	10.50	13.25	11.79	10.00	15.00	12.64
February.....	8.50	15.75	12.25	9.00	11.50	10.25	10.00	13.75	11.77	10.50	15.00	12.64	11.00	15.00	12.96
March.....	9.25	17.00	13.37	9.50	12.50	11.75	10.00	14.25	12.10	11.00	17.25	13.67	11.00	16.50	13.58
April.....	11.25	19.75	15.98	10.50	15.50	12.06	10.50	17.25	14.02	12.00	18.50	15.64	12.50	18.00	15.64
May.....	7.00	19.60	12.97	10.75	13.00	11.75	13.00	17.75	15.38	12.00	18.00	16.14	11.00	18.75	14.95
June.....	6.00	16.50	11.28	11.50	13.75	12.72	12.00	18.00	15.32	11.00	19.00	15.36	11.00	17.50	13.85
Jan.-June.....	6.00	19.75	12.91	9.00	15.50	11.46	10.00	18.00	13.40	10.50	19.00	14.21	10.00	18.75	13.94
July.....	6.00	16.60	11.44	11.00	12.00	11.50	8.00	13.00	10.44	11.00	17.00	13.85	11.00	14.50	12.55
August.....	8.00	16.00	11.76	11.00	12.50	11.62	9.00	12.00	10.50	11.00	17.00	13.82	10.50	14.50	12.46
September.....	7.50	15.25	11.29	10.50	11.75	10.97	8.00	12.00	10.33	9.00	16.00	11.67	9.25	13.25	11.38
October.....	7.00	13.50	9.89	6.00	8.50	7.25	8.00	10.50	9.05	7.00	12.00	9.42	7.00	13.00	9.76
November.....	6.50	13.50	9.63	7.75	9.00	8.41	7.50	13.50	9.26	8.00	11.50	9.38	9.00	11.75	10.15
December.....	6.50	13.50	9.64	8.00	8.50	8.25	7.00	13.00	8.84	8.00	11.00	9.24	8.00	13.50	9.67
July-Dec.....	6.00	16.60	10.61	6.00	12.50	9.67	7.00	13.50	9.74	7.00	17.00	11.23	7.00	14.50	11.00

SHEEP AND WOOL—Continued.

TABLE 225.—*Sheep: Farm price per 100 pounds, 15th of month, 1910–1918.*

Date.	1918	1917	1916	1915	1914	1913	1912	1911	1910
Jan. 15.....	\$10.55	\$7.33	\$5.52	\$4.95	\$4.67	\$4.35	\$3.89	\$4.47	\$5.63
Feb. 15.....	10.75	8.17	5.90	5.14	4.67	4.63	4.01	4.34	5.09
Mar. 15.....	11.41	9.21	6.35	5.36	4.77	4.97	4.12	4.45	5.64
Apr. 15.....	11.98	9.69	6.61	5.60	4.96	5.16	4.57	4.55	6.10
May 15.....	12.32	10.15	6.66	5.54	4.87	4.91	4.74	4.51	5.79
June 15.....	11.56	9.84	6.54	5.43	4.70	4.84	4.52	4.24	5.44
July 15.....	11.04	9.32	6.33	5.35	4.75	4.20	4.21	4.19	5.47
Aug. 15.....	10.99	9.33	6.22	5.16	4.87	4.32	4.26	3.98	4.68
Sept. 15.....	10.79	10.05	6.25	5.06	4.80	4.23	4.11	3.91	4.81
Oct. 15.....	10.35	10.24	6.20	5.18	4.81	4.16	4.19	3.68	4.68
Nov. 15.....	10.11	10.20	6.41	5.18	4.68	4.27	4.05	3.65	4.63
Dec. 15.....	9.46	10.44	6.77	5.38	4.95	4.46	4.21	3.71	4.54

TABLE 226.—*Wool (unwashed): Farm price per pound, 15th of month, 1910–1918.*

Date.	1918	1917	1916	1915	1914	1913	1912	1911	1910
	<i>Cents.</i>	<i>Cents.</i>	<i>Cents.</i>	<i>Cents.</i>	<i>Cents.</i>	<i>Cents.</i>	<i>Cents.</i>	<i>Cents.</i>	<i>Cents.</i>
Jan. 15.....	58.1	31.8	23.3	18.6	15.7	18.6	16.2	17.3	24.5
Feb. 15.....	57.1	32.7	24.2	20.2	15.7	18.7	16.3	17.3	24.6
Mar. 15.....	60.0	36.7	25.9	22.8	16.4	18.4	16.9	16.8	24.9
Apr. 15.....	60.0	38.8	26.3	22.7	16.8	17.7	17.3	15.7	22.3
May 15.....	58.2	43.7	28.0	22.0	17.2	16.3	17.8	14.7	22.8
June 15.....	57.4	49.8	28.7	23.7	18.4	15.6	18.7	15.5	19.5
July 15.....	57.5	54.3	28.6	24.2	18.5	15.9	18.9	15.4	19.0
Aug. 15.....	57.4	54.8	29.0	23.8	18.7	15.8	18.8	16.0	19.5
Sept. 15.....	59.7	54.2	28.4	23.3	18.6	15.8	18.7	15.6	17.7
Oct. 15.....	57.7	55.5	28.7	22.7	18.0	15.5	18.5	15.5	18.1
Nov. 15.....	56.4	55.9	29.4	22.7	18.1	15.6	18.6	15.6	17.9
Dec. 15.....	56.2	58.2	30.8	23.3	18.6	16.1	18.6	15.5	17.8

TABLE 227.—*Lambs: Farm price per 100 pounds, 15th of month, 1910–1918.*

Date.	1918	1917	1916	1915	1914	1913	1912	1911	1910
Jan. 15.....	\$13.83	\$9.59	\$7.29	\$6.47	\$6.16	\$6.03	\$5.22	\$5.71	\$5.82
Feb. 15.....	13.77	10.51	7.78	6.67	6.18	6.34	5.15	5.44	6.62
Mar. 15.....	14.11	11.46	8.10	6.06	6.31	6.56	5.38	5.49	7.37
Apr. 15.....	15.34	12.03	8.58	7.35	6.47	6.59	5.98	5.77	7.47
May 15.....	15.39	12.51	8.49	7.32	6.49	6.66	6.16	5.74	7.26
June 15.....	14.98	12.64	8.36	7.26	6.47	6.36	6.02	5.51	7.13
July 15.....	14.20	11.15	8.16	7.21	6.55	6.05	5.74	5.42	6.71
Aug. 15.....	14.20	12.08	8.15	6.70	6.26	5.50	5.60	5.25	5.70
Sept. 15.....	13.73	13.06	8.22	6.71	6.27	5.51	5.49	5.02	5.85
Oct. 15.....	13.20	14.09	8.02	6.70	6.09	5.51	5.42	4.68	5.78
Nov. 15.....	13.54	13.79	8.41	6.76	6.14	5.64	5.37	4.68	5.54
Dec. 15.....	12.44	13.81	8.72	7.02	6.33	5.85	5.70	4.93	5.66

SHEEP AND WOOL—Continued.

TABLE 228.—Breeds of sheep.

In January, 1918, the Bureau of Crop Estimates sent a schedule of inquiry to its special live-stock reporters in regard to breeds of sheep kept. The average of replies is given below.

State or division.	Fine-wool bloods.			Long wool or muttons.			Cross-breds.			Rams.		Number reporting drift to—	
	1918	5 years ago.	10 years ago.	1918	5 years ago.	10 years ago.	1918	5 years ago.	10 years ago.	Me-rino.	Mut-ton.	Me-rino.	Mut-ton.
Maine.....	P. ct. 7	P. ct. 8	P. ct. 10	P. ct. 73	P. ct. 70	P. ct. 65	P. ct. 20	P. ct. 22	P. ct. 25	P. ct. 10	P. ct. 90	3	10
New Hampshire.....	15	8	10	73	76	70	12	16	20	9	91	3	11
Vermont.....	16	32	51	72	58	39	12	10	10	13	87.	1	15
Massachusetts.....	8	15	11	87	75	76	5	10	13	5	95	1	6
Rhode Island.....				100	100	100					100		1
Connecticut.....	10	10	8	75	85	85	15	5	7	10	90	2	8
New York.....	11	15	30	75	69	45	14	16	25	10	90	5	36
New Jersey.....	15	15	25	78	70	55	7	15	20	15	85		4
Pennsylvania.....	25	46	44	45	33	31	30	21	25	35	65	8	20
N. Atlantic.....	17.1	28.1	34.1	61.7	53.5	41.8	21.2	18.4	24.1	20.8	79.2	23	111
Delaware.....	9	10	19	76	70	60	15	20	21	6	94		4
Maryland.....	7	15	17	32	20	17	61	65	66	13	87	4	1
Virginia.....	6	7	8	74	72	69	20	21	23	8	92	2	34
West Virginia.....	9	10	12	80	80	78	11	10	10	9	91	4	44
North Carolina.....	10	10	9	60	56	55	30	34	36	12	88	1	16
South Carolina.....	18	9	6	57	50	49	25	41	45	15	85	1	5
Georgia.....	2	4	2	35	33	35	63	63	63	5	95		9
Florida.....	6	5	4	50	90	87	44	5	9	3	97		3
S. Atlantic.....	7.3	8.9	10.0	68.4	68.2	65.9	24.3	22.9	24.1	8.7	91.3	12	116
Ohio.....	38	41	45	49	45	40	13	14	15	35	65	34	74
Indiana.....	13	14	17	73	70	65	14	16	18	15	85	10	105
Illinois.....	9	10	12	77	73	69	14	17	19	10	90	6	100
Michigan.....	18	19	25	68	67	60	14	14	15	15	85	12	65
Wisconsin.....	12	11	12	73	71	68	15	18	20	10	90	3	84
N. C. E. Miss. R.	23.4	25.0	28.9	62.9	60.0	54.7	13.7	15.0	16.4	21.7	78.3	65	428
Minnesota.....	12	14	18	73	68	62	15	18	20	8	92	7	68
Iowa.....	13	21	25	75	64	58	12	15	17	10	90	6	111
Missouri.....	13	14	17	66	62	58	21	24	25	15	85	10	147
North Dakota.....	21	25	34	59	50	41	20	25	25	17	83	5	23
South Dakota.....	16	15	15	71	74	75	13	11	10	19	81	6	36
Nebraska.....	20	21	22	55	56	53	25	23	25	18	82	5	39
Kansas.....	24	25	29	63	54	45	13	21	26	20	80	11	61
N. C. W. Miss. R.	15.2	17.8	20.9	68.2	63.2	58.7	16.6	19.0	20.4	14.4	85.6	50	485
Kentucky.....	6	8	10	63	50	43	31	42	47	10	90	7	54
Tennessee.....	5	9	11	70	56	48	25	35	41	8	92	3	36
Alabama.....	12	8	7	43	38	35	45	54	58	5	95	1	3
Mississippi.....	2	2	1	40	35	12	58	63	87				7
Louisiana.....				34			66						4
Texas.....	61	62	57	27	20	18	12	18	25	65	35	29	24
Oklahoma.....	26	30	47	51	50	26	23	20	25	12	88	4	18
Arkansas.....	8	5	5	26	25	20	66	70	75	15	85	6	21
S. Central.....	30.4	33.3	32.6	44.2	35.7	29.5	25.4	31.0	37.9	36.0	64.0	50	167
Montana.....	50	45	52	30	38	26	20	17	22	60	40	4	8
Wyoming.....	24	35	50	31	25	10	45	40	40	35	65	4	11
Colorado.....	60	51	44	27	26	25	13	23	31	63	37	10	4
New Mexico.....	70	64	55	15	18	20	15	18	25	75	25	8	3
Arizona.....	66	68	65	4	2	3	30	30	32	97	3	3	
Utah.....	50	50	47	39	35	36	11	15	17	46	54	3	7
Nevada.....	60	75	86	30	19	9	10	6	5	65	35	2	2
Idaho.....	40	51	69	42	33	15	18	16	16	63	67	6	15
Washington.....	15	17	20	62	75	70	23	8	10	40	60		6
Oregon.....	30	38	42	50	44	43	20	18	15	29	71	4	6
California.....	44	41	45	36	30	23	20	29	32	42	58	8	15
Far Western.....	46.0	48.6	53.2	23.3	29.5	22.6	21.7	21.9	24.2	50.9	49.1	52	77
United States.....	34.7	37.4	41.2	45.0	41.4	35.0	20.3	21.2	23.8	37.8	62.2	252	1,384

SHEEP AND WOOL—Continued.

TABLE 229.—Wool: Estimated production, 1917 and 1918.

State.	Production (000 omitted).		Weight per fleece.		Number of fleeces (000 omitted).	
	1918	1917	1918	1917	1918	1917
	<i>Pounds.</i>	<i>Pounds.</i>	<i>Pounds.</i>	<i>Pounds.</i>	<i>Number.</i>	<i>Number.</i>
Maine.....	883	833	6.7	6.6	132	126
New Hampshire.....	192	183	7.0	6.7	27	27
Vermont.....	663	597	7.2	7.3	92	82
Massachusetts.....	119	119	6.0	6.5	20	18
Rhode Island.....	24	24	6.0	6.2	4	4
Connecticut.....	76	75	5.5	5.5	14	14
New York.....	3,830	3,514	7.0	6.8	547	517
New Jersey.....	88	80	5.5	5.2	16	15
Pennsylvania.....	4,774	4,225	6.7	6.5	713	650
Delaware.....	31	31	5.7	5.8	5	5
Maryland.....	773	753	5.8	6.0	133	126
Virginia.....	1,918	1,862	4.7	4.6	408	405
West Virginia.....	2,830	2,695	5.2	5.0	544	539
North Carolina.....	570	553	4.0	3.8	142	146
South Carolina.....	103	95	4.0	4.0	26	24
Georgia.....	478	455	2.9	2.9	165	157
Florida.....	426	355	3.2	2.8	133	127
Ohio.....	12,600	12,000	7.3	7.4	1,726	1,622
Indiana.....	4,765	4,332	7.1	7.0	671	619
Illinois.....	4,048	3,855	8.0	7.9	506	488
Michigan.....	8,765	8,192	7.4	7.4	1,184	1,107
Wisconsin.....	2,850	2,500	7.6	7.9	375	316
Minnesota.....	3,112	2,964	7.4	7.8	421	380
Iowa.....	4,815	4,500	7.5	7.7	642	584
Missouri.....	5,532	4,810	7.0	7.0	790	687
North Dakota.....	1,560	1,418	7.6	7.4	205	192
South Dakota.....	4,747	3,738	7.4	7.3	641	512
Nebraska.....	1,696	1,600	7.8	7.5	217	219
Kansas.....	1,624	1,450	7.6	7.6	214	191
Kentucky.....	3,058	2,969	4.9	4.8	624	619
Tennessee.....	1,954	1,776	4.6	4.2	425	423
Alabama.....	368	350	3.5	3.3	105	106
Mississippi.....	619	491	4.0	3.3	155	149
Louisiana.....	594	560	3.7	3.6	161	156
Texas.....	11,250	10,045	7.0	7.0	1,607	1,435
Oklahoma.....	518	450	6.8	6.5	76	69
Arkansas.....	402	350	4.9	4.5	82	78
Montana.....	23,342	23,342	8.2	7.6	2,847	3,071
Wyoming.....	34,026	30,380	8.4	8.2	4,051	3,705
Colorado.....	9,261	8,820	6.2	6.4	1,494	1,378
New Mexico.....	17,132	18,422	5.6	5.8	3,059	3,176
Arizona.....	5,656	5,831	6.1	6.5	927	897
Utah.....	15,800	14,800	7.7	7.6	2,052	1,947
Nevada.....	10,000	9,000	7.0	7.3	1,429	1,233
Idaho.....	19,500	17,500	7.9	7.6	2,468	2,303
Washington.....	5,504	4,813	8.6	8.4	640	573
Oregon.....	12,500	12,000	8.0	8.2	1,562	1,463
California.....	12,545	12,180	7.0	7.0	1,792	1,740
United States.....	257,921	241,892	7.0	7.0	36,269	34,414
Pulled wool.....	42,000	40,000				

SHEEP AND WOOL—Continued.

TABLE 230.—Wool: Wholesale price per pound in Boston, 1913–1918.

Date.	Ohio fine, unwashed.			Kentucky quarter blood, unwashed.			Ohio XX, washed.			Ohio half-blood combing, washed.			Ohio Delaine, washed.			Michigan fine, unwashed.		
	Low.	High.	Av.	Low.	High.	Av.	Low.	High.	Av.	Low.	High.	Av.	Low.	High.	Av.	Low.	High.	Av.
1913.																		
Jan.–June.....	20	24	22.4	24	32	28.6	27	32	29.4	23	29	26.6	27	34	30.8	19	23	21.1
July–Dec.....	20	21	20.5	23½	26	24.2	25	30	26.5	23	25	23.9	26	28	27.3	19	20	19.5
1914.																		
Jan.–June.....	20	25	22.3	23½	27	24.5	25½	29	27.0	23	28	25.0	26	32	28.2	19	23	21.0
July–Dec.....	23	25	24.3	26	29	27.0	27	31½	29.6	27	30	28.3	28	32	30.9	22	23	22.8
1915.																		
Jan.–June.....	23	29	26.7	29	39	35.5	29	34	32.0	29	38	34.0	30	37	33.4	22	26	23.8
July–Dec.....	25	27½	26.9	36	39½	38.0	32	32½	32.1	32½	36	34.4	33½	36	34.5	23	27½	23.8
1916.																		
Jan.–June.....	26	31	29.6	38	41	39.4	32½	35	33.7	32	38	36.1	35½	40	37.6	25	28	26.9
July–Dec.....	30	38	32.6	41	50	44.6	35	47	37.5	37	46	40.9	38	52	41.9	27	37	29.8
1917.																		
January.....	38	40	39.6	50	52	51.5	46	50	47.2	45	48	46.8	52	53	52.8	37	39	37.8
February.....	42	44	43.2	51	56	54.0	50	55	52.6	47	54	51.5	54	60	56.5	39	42	41.0
March.....	44	46	44.5	57	58	57.5	53	55	54.0	53	53	53.0	58	60	59.0	41	44	42.1
April.....	45	48	47.0	58	60	59.0	53	57	55.4	53	38½	55.4	54	62	58.6	43	45	44.2
May.....	48	51	49.0	60	65	62.1	56	58	56.9	57	63	59.3	62	66	64.0	45	48	46.0
June.....	53	58	55.5	65	76	69.9	60	68	64.1	62	71	66.1	67	82	73.8	49	57	52.7
Jan.–June...	38	58	46.5	50	76	59.0	46	68	55.0	45	71	55.4	52	82	60.8	37	57	44.0
July.....	57	58	57.5	75	76	77.5	67	70	68.6	71	72	71.5	80	82	81.0	56	57	56.5
August.....	57	64	61.6	75	77	76.2	68	77	73.6	71	76	74.0	80	83	81.8	56	62	59.4
September.....	62	66	64.5	76	77	76.5	75	77	76.0	76	77	76.5	82	83	82.5	60	62	61.0
October.....	65	66	65.5	76	77	76.5	75	80	78.8	76	77	76.5	82	85	83.2	60	62	61.0
November.....	65	67	65.8	76	77	76.5	76	77	76.5	76	78	77.0	82	85	83.5	60	62	61.2
December.....	65	67	66.0	76	77	76.8	76	77	76.5	75	78	76.5	82	85	83.8	61	64	62.7
July–Dec....	57	67	63.5	75	77	76.7	67	80	75.0	71	78	75.3	80	85	82.6	56	64	60.3
1918.																		
January.....	65	67	66.0	77	77	77.0	76	77	77.5	76	78	77.2	83	85	84.0	63	64	63.5
February.....	65	67	66.0	77	77	77.0	76	77	76.5	77	78	77.2	83	85	84.0	63	64	63.5
March.....	65	67	66.0	77	77	77.0	76	77	76.5	77	78	77.6	83	85	84.0	63	64	63.5
April.....	65	67	66.0	77	78	77.1	76	77	76.5	78	78	78.0	83	87	85.5	63	64	63.4
May.....	63	67	64.2	76	78	76.4	77	78	77.5	78	79	78.4	87	90	88.8	62	64	62.8
June.....	61	62	62.0	76	76	76.0	77	78	77.5	75	76	76.2	88	90	89.0	61	62	61.2
Jan.–June...	61	67	65.0	76	78	76.8	76	78	76.8	75	79	77.4	83	90	85.9	61	64	63.0
July.....	67	67	67.0	78	78	78.0	77	77	77.0	87	87	87.0	64	64	64.0
August.....	64	64	64.0	76	76	76.0	78	78	78.0	90	90	90.0	63	63	63.0
September.....	62	62	62.0	76	76	76.0	78	78	78.0	90	90	90.0	61	61	61.0
October.....	64	64	64.0	78	78	78.0	77	77	77.0	87	87	87.0	64	64	64.0
November.....	63	63	63.0	76	76	76.0	78	78	78.0	90	90	90.0	63	63	63.0
December.....	61	61	61.0	76	76	76.0	78	78	78.0	90	90	90.0	61	61	61.0
July–Dec....	61	67	63.5	76	78	76.7	77	78	77.7	87	90	89.0	61	64	62.7

SHEEP AND WOOL—Continued.

TABLE 230.—Wool: Wholesale price per pound in Boston, 1913-1918—Continued.

Date.	Fine territory, staple scoured.			Fine medium territory, clothing scoured.			Texas 12 months, scoured.			Fine fall, Texas scoured.			Pulled, A super-scoured.			Pulled, B super-scoured.		
	Low.	High.	Av.	Low.	High.	Av.	Low.	High.	Av.	Low.	High.	Av.	Low.	High.	Av.	Low.	High.	Av.
1913.																		
Jan.-June.....	55	67	59.5	49	59	53.8	52	65	58.4	45	50	47.6	48	58	52.8	43	54	47.0
July-Dec.....	51	56	53.9	46	50	48.3	50	53	51.8	41	46	44.4	42	52	48.4	36	45	40.7
1914.																		
Jan.-June.....	51	63	57.2	46	55	51.2	50	62	55.5	41	50	45.0	43	53	49.3	36	43	40.7
July-Dec.....	60	65	62.7	55	57	56.0	55	62	59.1	42	50	47.2	50	55	51.6	40	56	45.9
1915.																		
Jan.-June.....	62	75	70.0	55	68	63.8	56	75	67.7	42	60	55.3	56	68	61.5	57	74	62.8
July-Dec.....	70	75	72.6	63	68	65.0	65	70	67.9	54	57	55.8	60	66	63.6	55	65	61.4
1916.																		
Jan.-June.....	73	85	79.8	65	75	71.7	67	77	72.6	53	55	54.5	63	68	66.2	59	66	62.4
July-Dec.....	82	112	93.0	75	87	78.8	77	100	84.9	55	78	63.8	65	85	70.0	60	80	67.5
1917.																		
January.....	110	120	115.6	85	95	91.4	100	105	102.5	75	78	76.5	83	85	84.0	75	80	77.5
February.....	120	125	122.5	92	105	98.5	105	120	113.0	75	82	79.9	83	100	91.6	75	90	82.5
March.....	125	135	131.5	100	110	104.0	120	125	122.5	82	84	83.0	100	105	102.5	90	95	92.5
April.....	130	140	136.2	110	115	111.9	120	130	126.2	82	95	87.5	107	130	115.9	98	125	111.1
May.....	135	150	143.8	110	120	113.8	130	145	137.5	90	105	97.5	140	150	145.6	120	135	126.9
June.....	145	175	165.9	120	135	125.5	145	175	160.5	100	120	108.5	145	150	147.5	130	140	133.5
Jan.-June....	110	175	135.9	85	135	107.5	100	175	127.0	75	120	88.8	83	150	114.5	75	140	104.0
July.....	172	177	175.4	135	150	143.8	165	175	170.6	115	120	117.5	145	150	147.5	130	140	135.0
August.....	175	180	178.8	140	155	147.5	165	170	167.7	115	120	117.5	145	150	147.5	130	140	135.0
September....	180	182	180.6	155	160	157.5	165	170	167.5	140	145	142.5	160	165	162.5	140	143	141.5
October.....	180	182	181.0	155	160	157.5	168	172	169.8	140	145	142.5	160	165	162.5	140	145	142.5
November.....	180	185	181.8	155	160	157.5	168	172	170.0	140	145	142.5	160	165	162.5	145	150	149.4
December.....	180	185	182.5	155	160	157.5	168	172	170.0	145	150	147.5	160	165	162.5	150	150	150.0
July-Dec....	172	185	180.0	135	160	153.6	165	175	169.3	115	150	135.0	145	165	157.5	130	150	142.2
1918.																		
January.....	180	190	185.0	155	160	157.5	168	172	170.0	145	155	150.0	160	165	163.1	150	150	150.0
February.....	185	190	186.2	155	160	157.5	168	172	170.0	150	155	152.5	160	165	162.5	145	150	148.8
March.....	182	185	183.5	155	160	157.5	168	172	170.0	140	155	142.5	145	165	152.5	140	150	145.5
April.....	185	187	186.0	155	160	157.5	168	175	172.6	145	150	147.5	160	165	162.5	150	155	152.5
May.....	180	180	180.4	155	160	157.5	172	175	173.5	145	150	147.5	160	165	162.5	145	150	147.5
June.....	180	180	180.0	155	160	157.5	172	175	173.5	145	150	147.5	160	165	162.5	145	150	147.5
Jan.-June....	180	190	183.5	155	160	157.5	168	175	171.6	140	155	147.9	145	165	160.9	140	155	148.6
July.....	185	185	185.0	175	175	175.0	150	150	150.0	155	160	157.5	145	150	147.5
August.....	180	180	180.0	175	175	175.0	150	150	150.0	155	160	157.5	145	150	147.5
September....	180	180	180.0	175	175	175.0	150	150	150.0	155	160	157.5	145	150	147.5
October.....	185	185	185.0	175	175	175.0	150	150	150.0	155	160	157.5	145	150	147.5
November.....	180	180	180.0	175	175	175.0	150	150	150.0	155	160	157.5	145	150	147.5
December.....	180	180	180.0	175	175	175.0	150	150	150.0	155	160	157.5	145	150	147.5
July-Dec....	180	185	181.7	175	175	175.0	150	150	150.0	155	160	157.5	145	150	147.5

SHEEP AND WOOL—Continued.

TABLE 231.—Wool: Wholesale price per pound, 1913-1918.

Date.	Boston, Ohio XX washed.			Philadelphia, Ohio XX washed.			St. Louis, best tub washed.		
	Low.	High.	Average.	Low.	High.	Average.	Low.	High.	Average.
1913.									
Jan.-June.....	Cents. 27	Cents. 32	Cents. 29.4	Cents. 24	Cents. 31	Cents. 28	Cents. 37	Cents. 32.5
July-Dec.....	25	30	26.5	22	25	28	35	28.7
1914.									
Jan.-June.....	25½	29	27.0	22	28	28	33	29.6
July-Dec.....	27	31½	29.6	25	29	31	33	31.6
1915.									
Jan.-June.....	29	34	32.0	29	34	31.7	31	41	37.6
July-Dec.....	32	32½	33.2	28	33½	33.1	40	44	40.6
1916.									
Jan.-June.....	32½	35	33.7	32½	37	33.6	42	48	44.3
July-Dec.....	34	47	37.5	34	44	36.9	47	49	47.7
1917.									
January.....	46	50	47.2	46	47	46.5	48	49	48.5
February.....	50	55	52.6	48	55	51.1	48	49	48.5
March.....	53	55	54.0	53	55	54.0	48	51	50.0
April.....	53	57	55.4	53	56	54.5	52	57	53.4
May.....	56	58	56.9	56	57	56.5	55	72	64.6
June.....	60	68	64.1	58	68	62.2	72	75	73.8
Jan.-June.....	46	68	55.0	46	68	54.1	48	75	56.5
July.....	67	70	68.6	65	70	67.9	75	80	76.7
August.....	68	77	73.6	68	77	71.9	80	80	80.0
September.....	75	77	76.0	75	77	76.0	80	83	80.1
October.....	75	80	78.8	75	80	77.5	83	85	83.7
November.....	76	77	76.5	75	80	76.8	83	85	83.6
December.....	76	77	76.5	75	77	76.0	83	85	84.0
July-Dec.....	67	80	75.0	65	80	74.4	75	85	81.4
1918.									
January.....	76	77	76.5	75	77	76.0	83	85	84.0
February.....	76	77	76.5	75	77	76.0	83	85	84.0
March.....	76	77	76.5	75	77	76.0	83	85	84.0
April.....	76	77	76.5	75	77	76.0	83	85	84.0
May.....	77	78	77.5	75	77	76.0	90	90	90.0
June.....	77	78	77.5	90	90	90.0
Jan.-June.....	76	78	76.8	75	77	76.0	83	90	86.0
July.....	77	77	77.0	90	91	90.3
August.....	78	78	78.0	91	91	91.0
September.....	78	78	78.0	91	91	91.0
October.....	77	77	77.0	91	91	91.0
November.....	78	78	78.0	91	91	91.0
December.....	78	78	78.0	91	91	91.0
July-Dec.....	77	78	77.7	90	91	90.9

SHEEP AND WOOL—Continued.

TABLE 232.—Wool: International trade, calendar years 1909–1917.

["Wool" in this table includes: Washed, unwashed, scoured, and pulled wool; slips, sheep's wool on skins (total weight of wool and skins taken); and all other animal fibers included in United States classification of wool. The following items have been considered as not within this classification: Corded, combed, and dyed wool; flocks, goatskins with hair on, mill waste, noils, and tops. See "General note," Table 196.]

EXPORTS.

[000 omitted.]

Country.	Average, 1909–1913.	1916 (prelim.)	1917 (prelim.)	Country.	Average, 1909–1913.	1916 (prelim.)	1917 (prelim.)
<i>From—</i>	<i>Pounds.</i>	<i>Pounds.</i>	<i>Pounds.</i>	<i>From—</i>	<i>Pounds.</i>	<i>Pounds.</i>	<i>Pounds.</i>
Algeria.....	19,871			Netherlands.....	26,362		154
Argentina.....	328,204	259,387		New Zealand.....	194,801	188,590	
Australia.....	676,679	406,287		Persia.....	10,023	7,403	
Belgium.....	196,440			Peru.....	9,333	13,651	
British India.....	56,496			Russia.....	32,406		
British South Africa.....	164,644	153,772	121,348	Spain.....	28,505	11,669	18,339
Chile.....	28,223			United Kingdom.....	42,027	13,403	
China.....	42,684	44,980	51,564	Uruguay.....	139,178		
France.....	84,973	22,157		Other countries.....	67,233		
Germany.....	42,817			Total.....	2,190,899		

IMPORTS.

<i>Into—</i>				<i>Into—</i>			
Austria-Hungary.....	63,942			Russia.....	106,184	19,609	
Belgium.....	300,367			Sweden.....	7,267		
British India.....	23,721			Switzerland.....	11,211	29,121	
Canada.....	7,794	19,918	11,741	United Kingdom.....	550,931	634,640	
France.....	601,628	172,314		United States.....	203,298	449,190	420,995
Germany.....	481,988			Other countries.....	58,275		
Japan.....	10,223	40,758		Total.....	2,458,820		
Netherlands.....	31,991	12,698					

SWINE.

TABLE 233.—Swine: Number and value on farms in the United States, 1867–1919.

NOTE.—Figures in *italics* are census returns; figures in roman are estimates of the Department of Agriculture. Estimates of members are obtained by applying estimated percentages of increase or decrease to the published numbers of the preceding year, except that a revised base is used for applying percentage estimates whenever new census data are available. It should also be observed that the census of 1910, giving numbers as of Apr. 15, is not strictly comparable with former censuses, which related to numbers June 1.

Jan. 1—	Number.	Price per head Jan. 1.	Farm value Jan. 1.	Jan. 1—	Number.	Price per head Jan. 1.	Farm value Jan. 1.
1867.....	24,694,000	\$4.03	\$99,637,000	1893.....	46,095,000	\$6.41	\$295,426,000
1868.....	24,317,000	3.29	79,976,000	1894.....	45,206,000	5.98	270,385,000
1869.....	23,316,000	4.65	108,451,000	1895.....	44,166,000	4.97	219,501,000
1870.....	26,751,000	5.80	155,108,000	1896.....	42,843,000	4.35	186,530,000
1870, census, June 1.....	<i>25,134,569</i>			1897.....	40,600,000	4.10	166,273,000
1871.....	29,458,000	5.61	165,312,000	1898.....	39,760,000	4.39	174,351,000
1872.....	31,796,000	4.01	127,453,000	1899.....	38,652,000	4.40	170,110,000
1873.....	32,632,000	3.67	119,632,000	1900.....	37,079,000	5.00	185,472,000
1874.....	30,861,000	3.98	122,695,000	1900, census, June 1.....	<i>62,868,041</i>		
1875.....	28,062,000	4.80	134,581,000	1901 ¹	56,982,000	6.20	353,012,000
1876.....	25,727,000	6.00	154,251,000	1902.....	48,699,000	7.03	342,121,000
1877.....	28,077,000	5.66	158,873,000	1903.....	46,923,000	7.78	364,974,000
1878.....	32,262,000	4.85	156,577,000	1904.....	47,009,000	6.15	289,225,000
1879.....	34,766,000	3.18	110,508,000	1905.....	47,321,000	5.99	283,255,000
1880.....	34,034,000	4.28	145,782,000	1906.....	52,103,000	6.18	321,803,000
1880, census, June 1.....	<i>47,681,700</i>			1907.....	54,794,000	7.62	417,791,000
1881.....	36,248,000	4.70	170,535,000	1908.....	56,084,000	6.05	339,030,000
1882.....	44,122,000	5.97	263,543,000	1909.....	54,147,000	6.55	354,794,000
1883.....	43,270,000	6.75	291,951,000	1910.....	47,782,000		
1884.....	44,201,000	5.57	246,301,000	1910, census, Apr. 15.....	<i>58,185,676</i>	9.17	533,309,000
1885.....	45,143,000	5.02	226,402,000	1911 ¹	65,620,000	9.37	615,170,000
1886.....	46,092,000	4.26	196,570,000	1912.....	65,410,000	8.00	523,328,000
1887.....	44,613,000	4.48	200,043,000	1913.....	61,178,000	9.86	603,109,000
1888.....	44,347,000	4.98	220,811,000	1914.....	58,933,000	10.40	612,951,000
1889.....	50,302,000	5.79	291,307,000	1915.....	64,618,000	9.87	637,479,000
1890.....	51,603,000	4.72	243,418,000	1916.....	67,766,000	8.40	569,573,000
1890, census, June 1.....	<i>57,409,583</i>			1917.....	67,503,000	11.75	792,898,000
1891.....	50,625,000	4.15	210,194,000	1918.....	70,978,000	19.54	1,387,261,000
1892.....	52,398,000	4.60	241,031,000	1919.....	75,587,000	22.04	1,665,987,000

¹ Estimates of numbers revised, based on census data.

SWINE—Continued.

TABLE 234.—Swine: Number and value on farms Jan. 1, 1918 and 1919, by States.

State.	Number (thousands) Jan. 1—		Average price per head, Jan. 1—		Farm value (thousands of dollars) Jan. 1—	
	1919	1918	1919	1918	1919	1918
Maine.....	110	100	\$24.00	\$23.00	2,640	2,300
New Hampshire.....	66	56	25.00	25.00	1,650	1,400
Vermont.....	125	118	23.00	22.20	2,875	2,620
Massachusetts.....	147	113	26.00	23.00	3,822	2,599
Rhode Island.....	14	16	28.00	25.00	392	400
Connecticut.....	83	64	27.00	26.00	2,241	1,664
New York.....	814	775	26.00	23.60	21,164	18,290
New Jersey.....	209	174	30.30	26.20	6,333	4,559
Pennsylvania.....	1,420	1,291	26.00	22.30	36,920	28,789
Delaware.....	71	64	19.50	17.00	1,384	1,088
Maryland.....	434	388	21.00	16.00	9,114	6,208
Virginia.....	1,134	1,042	18.00	13.90	20,412	14,484
West Virginia.....	439	422	18.50	16.00	8,122	6,752
North Carolina.....	1,546	1,400	21.00	17.10	32,466	23,940
South Carolina.....	1,056	960	21.00	15.50	22,176	14,880
Georgia.....	3,043	2,766	17.50	14.50	53,252	40,107
Florida.....	1,512	1,375	13.00	10.60	19,656	14,575
Ohio.....	4,266	3,878	21.80	20.50	92,999	79,499
Indiana.....	4,668	4,168	23.30	20.20	108,764	84,194
Illinois.....	5,724	5,111	25.00	22.00	143,100	112,442
Michigan.....	1,355	1,278	23.60	19.80	31,978	25,304
Wisconsin.....	2,181	2,019	26.50	22.30	57,796	45,024
Minnesota.....	2,784	2,400	28.50	23.50	79,344	56,400
Iowa.....	10,925	10,307	27.50	24.20	300,438	249,429
Missouri.....	4,943	4,494	18.50	18.50	91,446	83,139
North Dakota.....	456	507	24.70	20.80	11,263	10,546
South Dakota.....	1,654	1,504	27.50	23.50	45,485	35,344
Nebraska.....	4,250	4,250	26.50	24.40	112,625	103,700
Kansas.....	2,381	2,560	21.50	21.00	51,192	53,760
Kentucky.....	1,768	1,637	16.00	14.50	28,288	23,736
Tennessee.....	1,965	1,634	16.50	15.00	32,422	24,510
Alabama.....	2,223	2,128	17.00	14.50	37,791	30,856
Mississippi.....	2,282	1,902	16.00	15.00	36,512	28,530
Louisiana.....	1,599	1,568	15.20	13.60	24,305	21,325
Texas.....	2,320	2,900	17.00	14.10	39,440	40,890
Oklahoma.....	1,036	1,219	16.70	17.00	17,301	20,723
Arkansas.....	1,725	1,643	13.00	13.50	22,425	22,180
Montana.....	200	215	22.00	20.50	4,400	4,408
Wyoming.....	63	55	21.50	20.50	1,354	1,128
Colorado.....	406	387	22.00	20.00	8,932	7,740
New Mexico.....	93	86	19.00	15.70	1,767	1,350
Arizona.....	58	64	18.00	18.00	1,044	1,152
Utah.....	123	102	20.20	20.00	2,485	2,040
Nevada.....	40	37	18.00	19.00	720	703
Idaho.....	208	219	19.60	19.00	4,077	4,161
Washington.....	317	283	22.00	20.00	6,974	5,660
Oregon.....	348	325	19.10	17.50	6,647	5,688
California.....	1,003	974	18.00	17.50	18,054	17,045
United States.....	75,587	70,978	22.04	19.54	1,665,987	1,387,261

SWINE—Continued.

TABLE 235.—Hogs (live): Wholesale price per 100 pounds, 1913-1918.

Date.	Cincinnati.			St. Louis.			Chicago.			Kansas City.			Omaha.		
	Packing, fair to good.			Mixed packers.			Mixed and packers.								
	Low.	High.	Average.	Low.	High.	Average.	Low.	High.	Average.	Low.	High.	Average.	Low.	High.	Average.
1913.															
Jan.-June.....	7.45	10.00	8.64	7.20	9.50	8.44	6.95	9.60	8.31	6.95	9.25	6.70	9.05	8.16
July-Dec.....	7.60	9.60	8.58	7.25	9.50	8.46	7.15	9.65	8.20	7.20	9.25	7.34	9.15	7.96
1914.															
Jan.-June.....	8.00	9.15	8.61	7.75	8.95	8.49	7.60	9.00	8.37	7.55	8.80	7.35	8.73	8.20
July-Dec.....	6.40	9.90	8.32	6.80	9.85	8.31	6.50	10.20	8.06	6.65	9.75	6.50	9.35	7.89
1915.															
Jan.-June.....	6.50	8.00	7.35	6.00	7.97	7.25	6.15	7.95	7.01	6.35	7.90	7.07	6.00	7.95	6.93
July-Dec.....	6.25	8.70	7.41	6.15	8.75	7.36	5.80	8.95	7.07	6.00	8.65	7.19	4.00	8.95	6.79
1916.															
Jan.-June.....	6.40	10.25	8.84	6.00	10.25	9.01	6.45	10.30	8.97	6.25	10.05	8.84	6.00	9.90	8.65
July-Dec.....	7.35	11.40	10.06	8.90	11.50	10.17	8.50	11.60	9.94	7.75	11.00	9.71	8.50	11.10	9.74
1917.															
January.....	10.60	11.35	11.01	9.90	12.00	10.92	9.75	12.00	10.82	9.80	11.80	10.62	9.40	11.55	10.49
February.....	11.85	12.75	12.44	11.75	13.70	12.43	11.25	13.55	12.36	11.40	13.25	12.17	11.00	13.30	12.02
March.....	13.20	15.25	14.54	10.30	15.50	14.57	12.85	15.50	14.57	12.75	15.14	14.41	12.85	15.05	14.20
April.....	15.25	16.10	15.66	14.65	16.40	15.76	14.65	16.45	15.63	14.50	16.30	15.48	14.45	16.20	15.30
May.....	15.35	16.25	15.84	15.25	16.55	15.99	15.00	16.60	15.80	14.50	16.45	15.60	14.40	16.00	15.31
June.....	15.30	15.75	15.54	14.85	16.05	15.68	14.15	16.15	15.39	14.50	15.95	15.30	14.40	15.75	15.12
Jan.-June.....	10.60	16.25	14.17	9.90	16.55	14.23	9.75	16.60	14.10	9.80	16.45	13.93	9.40	16.20	13.74
July.....	15.40	15.65	15.52	15.00	16.12	15.59	14.00	16.30	15.10	14.50	16.60	15.21	14.00	15.65	14.92
August.....	16.00	19.00	17.19	15.50	19.80	17.58	14.50	20.00	16.88	14.50	19.35	16.87	14.50	19.60	16.82
September.....	18.00	18.75	18.32	16.00	19.35	18.45	16.50	19.70	18.04	17.00	19.50	18.26	16.25	19.45	18.06
October.....	15.40	19.15	17.60	15.50	19.75	17.88	14.25	19.65	17.00	15.00	19.65	17.39	15.30	19.50	17.36
November.....	15.50	17.25	16.58	16.25	18.00	17.43	15.75	18.10	16.95	14.75	17.85	16.64	16.20	17.90	17.24
December.....	16.25	17.40	16.76	15.85	17.80	17.01	15.40	17.75	16.68	15.00	17.70	16.33	15.75	17.45	16.72
July-Dec.....	15.40	19.15	17.00	15.00	19.80	17.32	14.00	20.00	16.78	14.50	19.65	16.78	14.00	19.60	16.85
1918.															
January.....	16.25	17.25	16.60	15.25	16.95	15.68	15.00	16.95	16.25	15.00	16.95	16.04	15.25	16.65	16.04
February.....	16.25	17.65	16.85	14.00	17.65	16.16	15.75	17.55	16.57	15.00	17.75	16.12	15.00	17.30	16.20
March.....	17.25	18.25	17.88	16.25	18.20	17.34	16.15	18.10	17.35	15.85	17.60	16.77	15.70	17.35	16.66
April.....	17.90	18.00	17.99	15.00	18.00	17.38	16.95	18.00	17.61	16.60	17.65	17.18	16.00	17.45	16.88
May.....	17.00	17.90	17.49	16.00	18.00	16.90	16.30	18.25	17.50	16.15	17.70	17.09	16.10	17.50	16.90
June.....	16.25	16.75	16.52	16.10	17.00	16.38	15.25	17.20	16.65	16.00	17.00	16.46	15.85	16.80	16.39
Jan.-June.....	16.25	18.25	17.22	14.00	18.20	16.64	15.00	18.25	16.99	15.00	17.75	16.61	15.00	17.50	16.51
July.....	16.65	18.75	17.61	16.35	19.30	17.88	16.25	19.30	17.61	16.30	19.00	17.55	16.10	18.85	17.42
August.....	18.75	19.85	19.34	18.50	20.00	19.54	17.10	19.25	18.44	17.65	20.15	19.07	17.90	19.65	18.65
September.....	19.75	20.25	19.98	18.90	20.75	19.99	18.35	20.40	19.24	19.00	20.65	19.76	18.25	20.40	19.45
October.....	16.00	19.60	17.66	16.75	19.75	18.02	14.00	19.25	17.24	14.50	19.75	17.65	15.25	19.40	17.47
November.....	14.50	17.75	16.79	16.75	18.50	17.74	16.50	18.40	17.19	17.00	18.25	17.43	16.25	18.15	17.21
December.....	14.50	17.40	15.99	14.00	18.20	17.17	15.60	17.80	17.04	17.00	17.75	17.26	16.00	17.70	17.04
July-Dec.....	14.50	20.25	17.90	14.00	20.75	18.39	14.00	20.40	17.79	14.50	20.65	18.12	15.25	20.40	17.87

SWINE—Continued.

TABLE 236.—Hogs: Farm price per 100 pounds, 1910–1918.

Date.	1918	1917	1916	1915	1914	1913	1912	1911	1910
Jan. 15.....	\$15.26	\$9.16	\$6.32	\$6.57	\$7.45	\$6.77	\$5.74	\$7.44	\$7.76
Feb. 15.....	15.03	10.33	7.07	6.34	7.75	7.17	5.79	7.04	7.87
Mar. 15.....	15.58	12.32	7.86	6.33	7.80	7.62	5.94	6.74	8.93
Apr. 15.....	15.76	13.61	8.21	6.48	7.80	7.94	6.78	6.17	9.26
May 15.....	15.84	13.72	8.37	6.77	7.60	7.45	6.79	5.72	8.59
June 15.....	15.37	13.50	8.21	6.80	7.43	7.61	6.65	5.66	8.46
July 15.....	15.58	13.35	8.40	6.84	7.72	7.81	6.64	5.92	8.15
Aug. 15.....	16.89	14.24	8.61	6.61	8.11	7.79	7.11	6.54	7.78
Sept. 15.....	17.50	15.69	9.22	6.79	8.11	7.68	7.47	6.53	8.27
Oct. 15.....	16.50	16.15	8.67	7.18	7.43	7.60	7.70	6.09	8.08
Nov. 15.....	15.92	15.31	8.74	6.35	7.00	7.33	7.05	5.86	7.61
Dec. 15.....	15.82	15.73	8.76	6.02	6.67	7.16	6.89	5.72	7.16

THE FEDERAL MEAT INSPECTION.

Some of the principal facts connected with the Federal meat inspection as administered by the Bureau of Animal Industry are shown in the following tables. The figures cover the annual totals beginning with the fiscal year 1907, which was the first year of operations under the meat-inspection law now in force. The data given comprise the number of establishments at which inspection is conducted; the number of animals of each species inspected at slaughter; the number of each species condemned, both wholly and in part, and the percentage condemned of each species and of all animals; the quantity of meat products prepared or processed under Federal supervision, and the quantity and percentage of the latter condemned.

Further details of the Federal meat inspection are published each year in the Annual Report of the Chief of the Bureau of Animal Industry.

TABLE 237.—Number of establishments inspected and total number of animals slaughtered under Federal inspection annually, 1907 to 1918.

Year ending June 30—	Estab-lish-ments.	Cattle.	Calves.	Swine.	Sheep.	Goats.	All animals.
1907.....	708	7,621,717	1,763,574	31,815,900	9,681,876	52,149	50,935,216
1908.....	787	7,116,275	1,995,487	35,113,077	9,702,545	45,953	53,973,337
1909.....	876	7,325,337	2,046,711	35,427,931	10,802,903	69,193	55,672,075
1910.....	919	7,962,189	2,295,099	27,656,021	11,149,937	115,811	49,179,057
1911.....	936	7,781,030	2,219,908	29,916,363	13,005,502	54,145	52,976,948
1912.....	940	7,532,005	2,242,929	34,966,378	14,208,724	63,983	59,014,019
1913.....	910	7,155,814	2,098,484	32,287,538	14,724,465	56,556	56,322,859
1914.....	893	6,724,117	1,814,904	33,289,705	14,958,834	121,827	56,909,387
1915.....	896	6,964,402	1,735,902	36,247,958	12,909,089	165,533	58,022,884
1916.....	875	7,404,288	2,048,022	40,482,799	11,985,926	180,356	62,101,391
1917.....	833	9,239,489	2,679,745	40,210,847	11,343,418	174,649	63,708,148
1918.....	884	10,938,287	3,323,077	35,449,247	8,769,498	149,503	58,629,612

TABLE 238.—Condemnations of animals at slaughter, 1907–1918.

Year ending June 30—	Cattle.			Calves.			Swine.		
	Whole.	Part.	Per cent. ¹	Whole.	Part.	Per cent. ¹	Whole.	Part.	Per cent. ¹
1907.....	27,933	93,174	1.58	6,414	245	0.38	105,879	436,161	1.70
1908.....	33,216	67,482	1.41	5,854	396	.31	127,933	636,589	2.18
1909.....	35,103	99,739	1.84	8,213	409	.42	86,912	799,300	2.50
1910.....	42,426	122,167	2.07	7,524	500	.35	52,439	726,829	2.82
1911.....	39,402	123,969	2.10	7,654	781	.38	59,477	877,528	3.13
1912.....	50,363	134,783	2.46	8,927	1,212	.45	129,002	323,992	1.30
1913.....	50,775	130,139	2.53	9,216	1,377	.50	173,937	373,993	1.70
1914.....	48,356	138,085	2.77	6,696	1,234	.44	204,942	422,275	1.88
1915.....	52,496	178,409	3.32	5,941	1,750	.44	213,905	464,217	1.87
1916.....	57,579	188,915	3.33	6,681	1,988	.42	195,107	546,290	1.83
1917.....	78,706	249,637	3.53	10,112	2,927	.49	158,480	528,288	1.71
1918.....	63,156	178,940	2.26	8,109	2,308	.31	113,079	347,006	1.30

TABLE 238.—*Condemnation of animals for slaughter, 1907–1918—Continued.*

Year ending June 30—	Sheep.			Goats.			All animals.		
	Whole.	Part.	Per cent. ¹	Whole.	Part.	Per cent. ¹	Whole.	Part.	Per cent. ¹
1907.....	9,524	296	0.10	42	0.08	149,792	529,876	1.33
1908.....	8,090	198	.09	33	1	.07	175,126	704,666	1.63
1909.....	10,747	179	.10	82	1	.12	141,057	899,628	1.87
1910.....	11,127	24,714	.32	226	1	.19	113,742	874,211	2.01
1911.....	10,789	7,394	.14	6111	117,383	1,009,672	2.13
1912.....	15,402	3,871	.13	84	1	.13	203,778	463,859	1.13
1913.....	16,657	939	.12	76	1	.14	250,661	506,449	1.34
1914.....	20,563	1,564	.15	746	8	.62	231,303	563,166	1.48
1915.....	17,611	298	.14	653	14	.40	290,606	644,688	1.61
1916.....	15,057	1,007	.13	663	161	.46	275,087	738,361	1.63
1917.....	16,749	437	.15	1,349	42	.80	265,396	781,331	1.64
1918.....	12,564	227	.15	419	1	.28	202,327	528,482	1.25

¹ Includes both whole and parts. It should be understood that the parts here recorded are primal parts; a much larger number of less important parts, especially in swine, are condemned in addition.

TABLE 239.—*Quantity of meat and meat food products prepared, and quantity and percentage condemned, under Federal supervision annually, 1907 to 1918.*

Year ending June 30—	Prepared or processed.	Condemned.	Per centage condemned.	Year ending June 30—	Prepared or processed.	Condemned.	Per centage condemned.
	<i>Pounds.</i>	<i>Pounds.</i>	<i>Per cent.</i>		<i>Pounds.</i>	<i>Pounds.</i>	<i>Per cent.</i>
1907.....	4,464,213,208	14,874,587	0.33	1913.....	7,094,809,809	18,851,930	0.27
1908.....	5,958,298,864	43,344,206	.73	1914.....	7,033,295,975	19,135,469	.27
1909.....	6,791,437,032	24,679,754	.36	1915.....	7,533,070,002	18,780,122	.25
1910.....	6,223,964,593	19,031,808	.31	1916.....	7,474,242,192	17,897,367	.24
1911.....	6,934,233,214	21,073,577	.31	1917.....	7,663,633,957	19,857,270	.26
1912.....	7,279,558,956	18,096,587	.25	1918.....	7,905,184,924	17,543,184	.22

The principal items in Table 239, in the order of magnitude, are: Cured pork, lard, lard substitute, sausage, and oleo products. The list includes a large number of less important items.

It should be understood that the above products are entirely separate and additional to the carcass inspection at time of slaughter. They are, in fact, reinspections of such portions of the carcass as have subsequently undergone some process of manufacture.

TABLE 240.—*Quantity of meat and meat food products imported, and quantity and percentage condemned or refused entry, 1914 to 1918.*

Year ending June 30—	Total imported.	Condemned.	Refused entry.	Percentage condemned or refused.
	<i>Pounds.</i>	<i>Pounds.</i>	<i>Pounds.</i>	<i>Per cent.</i>
1914 (9 months).....	197,389,348	551,859	0.28
1915.....	245,023,437	2,020,291	70,454	.85
1916.....	110,514,476	298,276	113,907	.37
1917.....	29,138,996	382,160	14,611	1.36
1918.....	59,025,484	989,916	414,452	2.38

IMPORTS AND EXPORTS OF AGRICULTURAL PRODUCTS.¹

TABLE 241.—*Agricultural imports of the United States during the 3 years ending June 30, 1918.*

[Compiled from reports of the foreign commerce and navigation of the United States, U. S. Department of Commerce.]

Article imported.	Year ending June 30—					
	1916		1917		1918 (preliminary).	
	Quantity.	Value.	Quantity.	Value.	Quantity.	Value.
ANIMAL MATTER.						
Animals, live:						
Cattle—						
For breeding purposes, number ²	439, 185	\$15, 187, 593	374, 826	\$13, 021, 259	293, 719	\$17, 852, 176
Horses—						
For breeding purposes, number ²	1, 536	\$659, 022	2, 684	1, 056, 033	879	706, 744
Other.....number ²	14, 020	959, 223	9, 900	832, 270	4, 220	480, 699
Total horses.....do....	15, 556	1, 618, 245	12, 584	1, 888, 303	5, 099	1, 187, 443
Sheep—						
For breeding purposes, number ²	235, 659	917, 502	160, 422	856, 645	177, 681	1, 979, 746
Swine.....number²						
All other, including fowls.....	4, 626	42, 615	5, 669	113, 457	12, 696	324, 182
		883, 124		723, 195		614, 831
Total live animals.....		18, 649, 079		16, 602, 859		21, 958, 378
Beeswax.....pounds..	2, 146, 380	594, 209	2, 685, 982	894, 318	1, 826, 618	632, 356
Dairy products:						
Butter.....do....	712, 998	212, 370	523, 573	192, 767	1, 805, 925	619, 303
Cheese.....do....	30, 087, 999	7, 058, 420	14, 481, 514	4, 465, 633	9, 839, 305	4, 089, 027
Cream.....gallons..	1, 193, 745	1, 042, 775	743, 819	666, 267	711, 502	675, 012
Milk.....do....		1, 515, 354		1, 746, 446		2, 997, 051
Total dairy products.....		9, 828, 919		7, 071, 113		8, 380, 393
Eggs.....dozen.....	732, 566	110, 638	1, 110, 322	268, 286	1, 619, 069	483, 636
Egg yolks or frozen eggs, pounds.....do....	6, 021, 672	921, 502	10, 317, 774	1, 732, 948	14, 597, 503	4, 057, 417
Feathers and downs, crude:						
Ostrich.....do....		2, 195, 497		534, 921		746, 709
Other.....do....		525, 654		944, 295		1, 212, 471
Fibers, animal:						
Silk—						
Cocoons.....pounds..	197, 073	142, 743	62, 056	54, 995	251, 447	319, 349
Raw, or as reeled from the cocoon.....pounds..	33, 070, 902	119, 484, 223	33, 868, 885	156, 085, 649	34, 447, 575	180, 906, 287
Waste.....do....	8, 657, 322	4, 706, 689	6, 420, 482	4, 431, 164	8, 583, 344	7, 229, 176
Total silk.....do....	41, 925, 297	124, 333, 655	40, 351, 423	160, 571, 808	43, 282, 366	188, 454, 812
Wool, and hair of the camel, goat, alpaca, and like animals—						
Class 1, clothing, pounds.....do....	403, 121, 585	112, 145, 657	279, 481, 501	101, 502, 941	303, 868, 940	165, 026, 343
Class 2, combing, pounds.....do....	13, 292, 160	3, 916, 708	17, 055, 953	6, 723, 737	13, 953, 957	8, 583, 978
Class 3, carpet, pounds.....do....	109, 268, 999	23, 955, 236	67, 672, 671	19, 814, 386	58, 994, 662	23, 867, 365
Hair of the Angora goat, alpaca, etc.....pounds..	9, 145, 278	2, 403, 133	8, 162, 093	3, 096, 106	2, 312, 375	1, 068, 225
Total wool.....do....	534, 828, 022	142, 420, 734	372, 372, 218	131, 137, 170	379, 129, 934	198, 545, 911
Total animal fibers, pounds.....do....	576, 753, 319	266, 754, 389	412, 723, 641	291, 708, 978	422, 412, 300	387, 000, 723

¹ Forest products come within the scope of the Department of Agriculture and are therefore included in alphabetical order in these tables.

² Including all imported free of duty.

TABLE 241.—Agricultural imports of the United States during the 3 years ending June 30, 1918—Continued.

Article imported.	Year ending June 30—					
	1916		1917		1918 (preliminary).	
	Quantity.	Value.	Quantity.	Value.	Quantity.	Value.
ANIMAL MATTER—contd.						
Gelatin.....pounds..	1,600,235	\$501,509	1,114,667	\$359,076	365,586	\$133,057
Glue and glue size....do...	3,008,485	217,033	6,265,597	925,000	2,048,543	343,241
Honey.....gallons..	221,224	97,461	427,650	289,317	590,777	843,696
Packing-house products:						
Blood, dried.....		196,600		389,455		462,703
Bones, cleaned.....						
Bones, hoofs, and horns.....		867,242		987,544		1,374,546
Bristles—						
Crude, unsorted, pounds.....	86,374	14,990	129,460	52,536	33,483	79,131
Sorted, bunched, or prepared.....pounds..	3,850,087	3,612,052	4,026,539	4,381,411	3,936,667	4,894,046
Total bristles...do...	3,936,461	3,627,042	4,155,999	4,433,947	3,970,150	4,973,177
Grease.....		930,635		861,973		3,161,233
Hair—						
Horse.....pounds..	6,198,938	2,071,429	6,337,754	2,224,576	3,955,109	1,284,174
Other animal....do...	9,692,037	983,342	6,771,033	813,298	4,028,839	550,306
Hide cuttings and other glue stock.....pounds..	(1)	972,106	33,639,707	1,452,273	21,710,205	936,393
Hides and skins, other than furs—						
Buffalo hides, dry, pounds.....	13,003,888	2,463,270	27,095,228	6,125,219	10,497,860	2,808,995
Calfskins—						
Dry.....pounds..	26,913,217	7,835,605	33,936,381	11,062,856	8,893,766	3,699,479
Green or pickled, pounds.....	37,222,276	9,071,349	12,399,814	4,530,193	4,267,549	1,577,122
Cattle hides—						
Dry.....pounds..	153,339,079	37,453,897	161,236,620	48,714,500	76,655,271	23,929,479
Green or pickled, pounds.....	280,838,692	50,596,221	225,363,408	51,236,153	190,844,499	43,820,645
Goatskins—						
Dry.....pounds..	85,505,514	25,198,246	92,425,345	51,777,399	56,735,829	29,741,953
Green or pickled, pounds.....	15,151,507	2,207,658	13,214,962	3,642,410	10,197,108	1,989,466
Horse and ass skins—						
Dry.....pounds..	6,779,725	1,236,440	12,185,138	3,731,858	2,698,857	637,286
Green or pickled, pounds.....	11,346,910	1,079,284	15,485,233	2,459,969	6,360,178	932,353
Kangaroo.....pounds..	1,219,129	722,300	958,629	721,754	670,685	709,263
Sheepskins²—						
Dry.....do.....	54,599,884	11,330,341	55,283,868	17,954,483	32,238,584	11,833,646
Green or pickled, pounds.....	46,859,397	7,509,009	40,446,730	11,626,832	23,230,331	7,272,342
Other.....pounds..	10,890,642	2,157,756	10,176,141	2,779,983	9,226,176	2,677,317
Total hides and skins, pounds.....	743,669,860	158,861,376	700,207,497	216,363,609	432,516,693	131,629,352
Meat—						
Cured—						
Bacon and hams, pounds.....	667,667	111,486	190,293	46,394	260,031	79,162
Meat prepared or preserved.....		325,381		981,212		7,320,101
Sausage, bologna, pounds.....	47,287	12,322	682	274	15,056	5,664
Fresh—						
Beef and veal, pounds.....	71,101,756	7,107,949	15,217,118	1,613,090	25,451,655	3,651,860
Mutton and lamb, pounds.....	20,257,999	1,784,310	4,684,131	555,846	2,007,601	267,948
Pork.....pounds..	2,169,084	234,873	1,651,227	280,795	1,847,733	373,301
Other, including meat extracts.....		1,486,395		3,773,082		15,157,317
Total meat.....		11,062,716		7,250,493		26,855,353

¹ Not stated.² Except sheepskins with the wool on.

TABLE 241.—Agricultural imports of the United States during the 3 years ending June 30, 1918—Continued.

Article imported.	Year ending June 30—					
	1916		1917		1918 (preliminary).	
	Quantity.	Value.	Quantity.	Value.	Quantity.	Value.
ANIMAL MATTER—contd.						
Packing-house products— Continued.						
Oleo stearin.....pounds..	910,478	\$81,280	1,113,277	\$114,640	6,575,379	\$1,118,422
Rennets.....		86,706		13,154		62,173
Sausage casings.....		3,865,877		4,219,235		3,631,025
Total packing-house products.....		183,611,351		239,129,197		176,038,857
Total animal matter..		484,007,241		560,463,308		601,835,934
VEGETABLE MATTER.						
Argols, or wine lees, pounds..	34,721,043	5,306,246	23,925,808	3,824,882	30,267,388	5,443,628
Breadstuffs. (See Grain and grain products.)						
Broom corn.....long tons..	158	24,643	30	4,743	2,482	474,225
Cocoa and chocolate:						
Cocoa—						
Crude, leaves and shells of.....pounds.....	243,231,939	35,143,865	338,653,876	39,834,279	399,040,401	41,277,479
Chocolate.....do.....	2,347,162	660,377	1,829,521	553,139	271,877	94,899
Total cocoa and choc- olate.....pounds.....	245,579,101	35,804,242	340,483,397	40,387,418	399,312,278	41,372,378
Coffee.....do.....	1,201,104,485	115,485,970	1,319,870,802	133,184,000	1,143,890,889	103,058,536
Coffee substitutes:						
Chicory root— Roasted, ground, or otherwise prepared, pounds.....	448	48	353,271	37,383	5,381	598
Fibers, vegetable:						
Cotton.....pounds..	232,801,062	40,150,342	147,061,635	40,429,526	103,325,647	36,020,483
Flax.....long tons..	6,939	3,508,295	7,918	4,236,232	5,607	5,818,473
Hemp.....do.....	6,506	1,642,418	9,635	2,487,477	6,813	2,748,376
Istle, or Tampico fiber, long tons.....	30,812	2,905,494	32,680	2,913,414	30,810	2,972,891
Jute and jute butts, long tons.....	108,322	7,914,782	112,695	9,855,196	78,312	7,213,641
Kapoc.....long tons..	5,642	1,139,648	6,861	1,671,245	4,680	1,239,475
Manila.....do.....	78,892	14,066,838	76,765	17,274,455	86,220	30,434,824
New Zealand flax..do.....	7,180	1,130,995	7,910	1,718,740	10,478	3,620,959
Sisal grass.....do.....	228,610	25,803,433	143,407	25,931,525	150,164	51,532,666
Other.....do.....	9,313	1,348,159	10,747	1,621,474	16,769	3,461,165
Total vegetable fibers.		99,610,404		108,139,284		145,062,953
Forest products:						
Cinchona bark.....pounds..	3,947,320	777,637	2,531,397	685,936	3,273,628	810,775
Cork wood or cork bark..		3,134,884		3,870,389		3,061,827
Dyewoods, and extracts of—						
Dyewoods—						
Logwood..long tons..	134,629	3,437,698	122,794	4,137,400	52,027	1,066,455
Other.....do.....	24,592	468,669	8,895	189,176	35,449	951,667
Total dyewoods,do.....	159,221	3,906,367	131,689	4,326,576	87,476	2,018,122
Extracts and decoctions of.....pounds..	5,471,251	382,880	2,500,854	152,619	4,573,925	219,993
Total dyewoods, and extracts of.....		4,289,247		4,479,195		2,238,115

TABLE 241.—Agricultural imports of the United States during the 3 years ending June 30, 1918—Continued.

Article imported.	Year ending June 30—					
	1916		1917		1918 (preliminary).	
	Quantity.	Value.	Quantity.	Value.	Quantity.	Value.
VEGETABLE MATTER—CON.						
Forest products—Contd.						
Gums—						
Camphor—						
Crude.....pounds..	4,574,430	\$1,236,172	6,884,950	\$2,101,239	3,638,384	\$1,451,050
Refined.....do.....	1,866,154	619,320	4,263,815	1,972,351	1,189,932	819,431
Chicle.....do.....	7,346,969	2,829,184	7,440,022	3,538,353	6,408,093	3,454,193
Copal, kauri, and damar pounds.....	44,528,856	3,587,020	41,443,760	3,402,403	30,003,549	2,868,863
Gambier, or terra ja- ponica.....pounds..	12,819,859	928,924	10,133,625	859,873	8,964,832	955,352
India rubber, gutta- percha, etc.—						
Balata.....pounds..	2,544,405	996,102	3,287,445	1,649,452	2,449,881	1,278,610
Guayule gum.....do.....	2,816,068	880,813	2,854,372	764,484	4,307,539	1,341,095
Gutta-joolatong, or East Indian gum, pounds.....	27,858,335	1,322,262	23,376,389	1,044,022	17,475,863	975,816
Gutta-percha.....do.....	3,188,449	342,226	2,021,794	332,223	1,151,312	147,323
India rubber.....do.....	267,775,557	155,044,790	333,373,711	189,328,674	389,599,015	202,800,392
Total india rubber, etc.....pounds..	304,182,814	158,586,193	364,913,711	193,118,855	414,983,610	206,543,236
Shellac.....do.....	25,817,509	3,302,825	32,539,522	7,623,647	22,913,256	9,514,651
Other.....do.....		2,324,092		2,012,417		3,026,098
Total gums.....		173,413,730		214,629,138		228,632,874
Ivory, vegetable, pounds.	32,942,115	840,464	51,699,719	1,427,780	42,873,018	1,255,719
Naval stores:						
Turpentine, spirits of, gallons.....	19,035	8,189	18,661	8,691		
Tanning materials:						
Mangrove bark, long tons.....	21,186	582,922	10,565	299,897	3,529	72,956
Quebracho, extract of, pounds.....	81,501,952	5,432,468	59,808,734	5,198,904	101,523,282	4,917,212
Quebracho wood, long tons.....	106,864	1,598,465	73,367	1,274,660	45,440	718,567
Sumac, ground, pounds.....	21,542,390	555,276	11,637,023	365,173	14,046,662	467,663
Other.....do.....		668,166		792,064		496,070
Total tanning ma- terials.....		8,837,297		7,930,698		6,672,468
Wood, not elsewhere spec- ified—						
Brier root or brierwood and ivy or laurel root		457,537		589,607		555,201
Chair cane or reed.....		265,305		235,488		202,585
Cabinet woods, unsawed—						
Cedar.....M feet..	14,369	740,488	12,582	693,675	12,354	840,323
Mahogany.....do.....	39,855	2,781,372	42,780	2,888,615	51,681	3,731,389
Other.....do.....		489,247		684,562		473,751
Total cabinet woods		4,011,107		4,266,852		5,045,463
Logs and round timber, M feet.....	150,401	1,417,859	134,841	1,270,348	69,394	815,247
Lumber—						
Boards, deals, planks, and other sawed lumber.....M feet..	1,218,416	23,131,327	1,175,319	24,514,751	1,282,747	32,692,209
Laths.....M.....	771,823	2,207,223	766,286	2,280,656	410,626	1,376,273
Shingles.....M.....	1,769,333	3,593,696	1,924,139	4,568,340	1,378,465	5,453,951
Other.....do.....		709,696		730,158		881,122
Total lumber.....		29,641,942		32,093,905		40,403,555

TABLE 241.—Agricultural imports of the United States during the 3 years ending June 30, 1918—Continued.

Article imported.	Year ending June 30—					
	1916		1917		1918 (preliminary).	
	Quantity.	Value.	Quantity.	Value.	Quantity.	Value.
VEGETABLE MATTER—CON.						
Forest products—Contd.						
Pulp wood—						
Peeled.....cords..	627,290	\$3,959,732	639,816	\$4,285,282	822,816	\$7,821,335
Rosseed.....do....	164,714	1,282,658	162,818	1,295,957	138,690	1,621,306
Rough.....do.....	187,006	1,131,359	214,180	1,307,884	210,527	1,645,781
Rattan and reeds.....		1,720,816		1,171,052		1,781,239
All other.....		793,692		689,234		1,281,626
Total wood, n. e. s.....		44,682,007		47,205,609		61,173,338
Wood pulp—						
Chemical—						
Bleached long tons..	55,760	3,025,941	47,767	4,723,371	18,044	2,135,384
Unbleached do.....	264,882	10,693,736	381,601	30,720,219	296,465	23,314,875
Mechanical do.....	186,406	3,148,173	270,107	7,018,404	189,599	6,138,831
Total wood pulp, long tons.....	507,048	16,867,850	699,475	42,461,994	504,108	31,589,090
Total forest products.....		252,851,305		322,699,430		335,434,206
Fruits:						
Fresh or dried—						
Bananas.....bunches..	36,754,704	12,106,158	34,661,179	12,724,198	34,549,383	15,147,643
Currants.....pounds..	23,373,029	1,382,839	10,476,534	1,056,525	5,168,070	561,904
Dates.....do.....	31,075,424	547,433	25,485,361	622,934	5,572,908	249,621
Figs.....do.....	7,153,250	315,831	16,479,733	704,164	10,473,219	715,423
Grapes.....cubic feet	623,856	703,274	1,402,446	1,656,609	556,558	648,093
Lemons.....pounds..		2,062,030		2,163,583		2,179,211
Olives.....gallons..	5,938,446	2,433,304	5,641,759	2,338,615	2,385,059	1,062,487
Oranges.....pounds..		89,464		160,710		62,906
Pineapples.....		964,623		935,906		801,298
Raisins.....pounds..	1,024,296	143,750	1,850,219	234,560	843,533	153,319
Other.....		1,582,600		1,936,561		2,114,444
Total fresh or dried.....		22,331,306		24,534,365		23,696,349
Prepared or preserved.....		954,523		781,586		712,428
Total fruits.....		23,285,829		25,315,951		24,408,777
Grain and grain products:						
Grain—						
Corn.....bushels..	5,208,497	2,865,003	2,267,299	1,488,529	3,196,420	3,483,101
Oats.....do.....	665,314	302,547	761,644	473,476	2,591,077	1,963,447
Wheat.....do.....	5,703,078	5,789,321	24,138,817	41,900,498	28,177,281	56,873,063
Total grain.....do.....	11,576,889	8,956,871	27,167,760	43,862,503	33,964,778	62,319,611
Grain products—						
Bread and biscuit.....		213,400		148,401		100,141
Macaroni, vermicelli, etc.....pounds..	21,789,602	1,525,695	3,472,503	262,909	669,524	54,713
Meal and flour—						
Wheat flour, barrels..	329,905	1,689,418	174,704	1,458,279	675,096	6,372,333
Other.....		3,251,976		3,664,279		7,445,828
Total grain products.....		6,680,489		5,533,868		13,973,015
Total grain and grain products.....		15,637,360		49,396,371		76,292,626
Hay.....long tons..	43,184	679,412	58,147	628,021	410,738	4,618,764
Hops.....pounds..	675,704	144,627	236,849	59,291	121,288	72,450
Indigo.....do.....	6,599,583	8,235,670	2,812,739	4,108,910	3,126,497	3,895,114
Licorice root.....do....	41,003,295	1,609,571	59,400,224	2,190,822	26,982,932	1,853,927

TABLE 241.—Agricultural imports of the United States during the 3 years ending June 30, 1918—Continued.

Article imported.	Year ending June 30—					
	1916		1917		1918 (preliminary).	
	Quantity.	Value.	Quantity.	Value.	Quantity.	Value.
VEGETABLE MATTER—CON.						
Liquors, alcoholic:						
Distilled spirits—						
Brandy.....proof galls..	536,342	\$1,576,481	420,567	\$1,502,845	234,912	\$1,149,969
Cordials, liqueurs, etc., proof galls.....	330,452	794,553	357,311	902,696	76,120	215,803
Gin.....proof galls.....	805,749	749,775	263,520	439,244	112,649	256,158
Whisky.....do.....	1,742,197	3,677,662	1,676,151	4,404,486	796,267	2,487,831
Other.....do.....	538,759	433,098	397,934	543,620	157,148	221,722
Total distilled spirits, proof galls.....	3,953,499	7,231,569	3,115,483	7,792,891	1,377,096	4,331,483
Malt liquors—						
Bottled.....gallons.....	872,402	850,913	632,064	717,653	298,390	416,576
Unbottled.....do.....	1,740,333	605,980	1,608,113	682,843	463,676	292,331
Total malt liquors, gallons.....	2,612,735	1,456,893	2,240,177	1,400,496	762,066	708,907
Wines—						
Champagne and other sparkling...doz. qts..	206,210	3,532,022	195,714	3,442,645	124,230	2,167,627
Still wines—						
Bottled.....doz. qts..	546,119	2,197,311	534,402	2,485,014	415,491	2,237,116
Unbottled.....gallons..	3,455,756	2,267,561	3,167,400	2,558,086	2,357,862	2,209,960
Total still wines.....		4,464,872		5,043,100		4,447,076
Total wines.....		7,996,894		8,485,745		6,614,703
Total alcoholic liq- uors.....		16,685,356		17,679,132		11,655,093
Malt, barley. (See Grain and grain products.)						
Malt liquors. (See Liq- uors, alcoholic.)						
Nursery stock:						
Plants, trees, shrubs, and vines—						
Bulbs, bulbous roots or corms, cultivated for their flowers or foli- age.....M.....						
Other.....	231,733	2,180,687	293,318	2,886,189	233,219	2,804,057
		1,508,677		1,078,324		523,640
Total nursery stock...		3,689,364		3,964,513		3,327,697
Nuts:						
Almonds—						
Shelled.....pounds..	13,667,766	3,700,298	18,413,225	4,621,100	19,561,155	4,956,419
Unshelled.....do.....	2,929,155	272,815	5,010,833	548,826	4,278,990	497,989
Coconuts, unshelled.....		1,876,966		2,587,535		2,788,635
Coconut meat, broken, or copra—						
Not shredded, desic- cated, or prepared, pounds.....						
	110,077,844	4,551,427	247,057,739	12,517,982	486,996,112	26,945,569
Shredded, desiccated, or prepared, pounds.....						
	8,535,725	698,357	9,743,024	727,424	20,579,973	2,396,104
Cream and Brazil, pounds.....						
	14,798,912	917,613	14,627,742	712,433	30,439,095	1,470,089
Filberts—						
Shelled.....pounds..	1,133,915	230,854	2,058,732	487,021	3,279,807	615,226
Unshelled.....do.....	9,785,545	819,598	11,181,301	1,354,257	17,366,979	1,869,430
Peanuts—						
Shelled.....do.....	19,392,832	722,939	27,180,748	1,193,364	73,362,215	4,617,560
Unshelled.....do.....	9,020,848	328,099	7,806,012	339,811	3,150,747	153,054
Walnuts—						
Shelled.....do.....	14,228,714	3,157,933	13,058,518	3,713,340	11,155,660	4,251,567
Unshelled.....do.....	22,630,220	1,899,012	25,666,844	2,497,454	12,133,510	1,438,944
Other.....		1,996,596		1,575,139		846,727
Total nuts.....		21,172,417		32,875,686		52,847,313

TABLE 241.—Agricultural imports of the United States during the 3 years ending June 30, 1918—Continued.

Article imported.	Year ending June 30—					
	1916		1917		1918 (preliminary).	
	Quantity.	Value.	Quantity.	Value.	Quantity.	Value.
VEGETABLE MATTER—CON.						
Oil cake.....pounds..	37,645,777	\$408,808	52,671,866	\$554,871	35,149,142	\$574,032
Oils, vegetable:						
Fixed or expressed—						
Cocoa butter or butter-						
ine.....pounds..	400,371	129,654	166,172	55,564	405	74
Coconut oil.....pounds..	66,007,560	6,047,183	79,223,398	9,132,095	259,194,853	30,919,783
Cottonseed.....do..	17,180,542	915,972	13,703,126	1,039,080	14,291,313	1,629,111
Flaxseed or linseed,						
gallons.....	50,148	33,295	110,808	76,530	50,827	32,203
Nut oil, or oil of nuts,						
n. e. s.—						
Chinese nut.gallons..	4,968,262	1,977,823	6,864,110	4,046,132	4,815,740	4,038,072
Peanut.....do....	1,475,123	818,283	3,026,188	2,036,592	8,288,756	7,311,824
Olive for mechanical						
purposes.....gallons..	884,944	684,896	651,018	615,350	114,324	94,629
Olive, salad.....do....	7,224,431	9,746,672	7,533,149	10,502,671	2,537,512	3,873,211
Palm oil.....pounds..	40,496,731	2,885,595	36,074,059	3,316,417	27,405,231	2,527,301
Palm kernel.....do....	6,760,928	512,666	1,857,038	197,237	18,618	2,583
Rapeseed.....gallons..	2,561,244	1,426,659	1,084,905	645,090	3,056,438	2,702,920
Soya bean.....pounds..	98,119,695	5,128,200	162,690,235	11,410,606	336,824,646	32,827,460
Other.....		516,500		495,191		2,027,137
Total fixed or ex-						
pressed.....		30,823,398		43,568,555		87,986,308
Volatile or essential—						
Birch and cajepu.....		22,175		33,302		25,981
Lemon.....pounds..	543,857	441,910	449,735	373,933	628,057	427,318
Other.....		2,645,571		3,038,177		3,884,287
Total volatile or es-						
sential.....		3,109,656		3,445,412		4,337,586
Total vegetable oils.....		33,933,054		47,013,967		92,323,894
Opium, crude.....pounds..	146,658	879,699	86,812	843,418	157,834	2,443,228
Rice, rice meal, etc.:						
Rice—						
Cleaned.....pounds..	121,023,906	2,867,453	97,453,036	2,735,702	345,676,204	12,224,984
Uncleaned, including						
paddy.....pounds..	87,671,332	2,215,273	80,865,798	2,290,173	62,317,754	2,558,034
Rice flour, rice meal,						
and broken rice,						
pounds.....	55,628,767	1,010,885	37,730,024	747,922	48,064,650	1,528,687
Total rice, etc.,						
pounds.....	264,324,005	6,093,611	216,048,858	5,773,797	456,058,608	16,311,705
Sago, tapioca, etc.....		2,226,697		3,712,956		5,530,889
Seeds:						
Castor beans or seeds,						
bushels.....	1,071,963	1,555,899	766,857	1,184,985	1,222,934	2,640,902
Clover—						
Red.....pounds..	33,476,401	4,918,171	5,971,267	936,092	905,709	162,418
Other.....do....	8,363,360	822,572	12,200,892	1,569,782	7,072,386	1,322,027
Flaxseed or linseed,						
bushels.....	14,679,233	20,220,921	12,393,988	25,149,669	13,187,609	33,850,054
Grass seed,n. e. s. pounds..	8,790,920	698,630	9,187,613	849,630	5,974,944	504,240
Sugar beet.....do....	9,042,490	1,030,788	14,469,774	1,684,867	15,635,542	4,541,226
Other.....		4,324,779		4,504,640		7,820,756
Total seeds.....		33,571,760		35,879,665		50,841,623

TABLE 241.—Agricultural imports of the United States during the 3 years ending June 30, 1918—Continued.

Article imported.	Year ending June 30—					
	1916		1917		1918 (preliminary).	
	Quantity.	Value.	Quantity.	Value.	Quantity.	Value.
VEGETABLE MATTER—CON.						
Spices:						
Unground—						
Cassia, or cassia vera, pounds.....	9,707,982	\$623,478	8,744,044	\$740,846	8,220,023	\$856,035
Ginger root, not preserved, pounds.....	7,322,399	540,007	2,590,279	243,962	6,554,069	601,392
Pepper, black or white, pounds.....	37,389,324	4,505,380	23,961,966	3,636,049	38,545,653	6,043,483
Other.....pounds..	26,452	2,107	13,735	879
Total unground, pounds.....	54,446,157	5,670,972	35,310,074	4,621,736	53,319,745	7,500,910
Ground.....pounds..	28,071,632	3,277,757	23,220,288	3,123,286	24,751,425	4,018,304
Total spices....do....	82,517,789	8,948,729	58,530,362	7,745,022	78,071,170	11,519,214
Spirits, distilled. (See Liquors, alcoholic.)						
Starch.....pounds..	2,467,038	123,838	20,647,893	973,530	23,852,145	1,673,477
Sugar and molasses:						
Molasses.....gallons..	85,716,673	3,775,894	110,237,888	10,946,571	130,730,861	9,177,833
Sugar—						
Raw—						
Beet.....pounds..	2,050	174	28,847	1,443	750	73
Cane.....do.....	5,631,272,766	208,572,890	5,329,537,360	230,574,221	4,898,277,025	236,105,886
Maple sugar and sirup.....pounds..	1,886,933	196,335	3,129,647	370,030	5,049,474	909,412
Total raw....do....	5,633,161,749	208,769,399	5,332,745,854	230,945,694	4,903,327,249	237,015,371
Total sugar and molasses.....	212,545,293	241,893,265	246,193,204
Tea.....pounds..	109,865,935	20,599,857	103,364,410	19,265,264	151,314,932	30,889,030
Tea, waste, etc., for manufacturing.....pounds..	4,794,542	200,115	7,975,343	494,280
Tobacco:						
Leaf—						
Wrapper.....pounds..	5,070,308	\$7,246,942	3,957,489	\$5,304,687	4,515,344	\$5,444,673
Filler and other leaf, pounds.....	43,007,648	17,382,253	45,147,630	20,617,968	74,852,219	39,875,851
Total tobacco, pounds.....	48,077,956	24,629,195	49,105,119	25,922,655	79,367,563	45,320,524
Vanilla beans.....pounds..	914,386	1,697,543	799,893	1,662,578	914,668	1,475,676
Vegetables:						
Fresh and dried—						
Beans.....bushels..	662,759	1,288,034	3,747,993	12,137,048	4,145,625	17,274,504
Onions.....do.....	815,872	749,150	1,757,948	1,820,396	1,313,402	1,032,834
Peas, dried.....do....	940,321	2,868,683	1,163,021	3,035,052	2,068,054	5,885,072
Potatoes.....do....	209,532	331,814	3,079,025	4,705,812	1,180,480	1,456,136
Other.....do.....	1,907,879	2,668,321	2,150,537
Total fresh and dried.....	7,145,560	24,366,629	27,799,08
Prepared or preserved—						
Mushrooms...pounds..	4,313,095	985,408	4,384,788	1,463,164	2,050,803	798,697
Pickles and sauces.....	515,048	1,179,959	309,124
Other.....do.....	2,165,377	2,141,137	1,268,865
Total prepared or preserved.....	3,665,833	4,784,260	2,376,686
Total vegetables.....	10,811,393	29,150,889	30,175,769

TABLE 241.—Agricultural imports of the United States during the 3 years ending June 30, 1918—Continued.

Article imported.	Year ending June 30—					
	1916		1917		1918	
	Quantity.	Value.	Quantity.	Value.	Quantity.	Value.
VEGETABLE MATTER—CON.						
Vinegar.....gallons..	234,396	\$76,308	203,504	\$88,037	68,772	\$34,228
Wax, vegetable...pounds.	9,727,312	1,580,530	7,216,103	1,739,199	8,707,396	2,693,258
Wines. (See Liquor, alcoholic.)						
Total vegetable matter, including forest products.....	958,548,894		1,167,208,230		1,347,818,036	
Total vegetable matter, excluding forest products.....	705,697,589		8,445,508,800		1,012,383,830	
Total agricultural imports, including forest products.....	1,442,556,135		1,727,671,538		1,949,653,970	
Total agricultural imports, excluding forest products.....	1,189,704,830		1,404,972,108		1,614,219,764	

TABLE 242.—Agricultural exports (domestic) of the United States during the 3 years ending June 30, 1918.

Article exported.	Year ending June 30—					
	1916		1917		1918 (preliminary).	
	Quantity.	Value.	Quantity.	Value.	Quantity.	Value.
ANIMAL MATTER.						
Animals, live:						
Cattle.....number..	21,287	\$2,378,248	13,387	\$949,503	18,213	\$1,247,800
Horses.....do....	357,553	73,531,146	278,674	59,525,329	84,765	14,923,663
Mules.....do....	111,915	22,960,312	136,689	27,800,854	28,879	4,885,406
Sheep.....do....	52,278	231,535	58,811	367,935	7,959	97,028
Swine.....do....	22,048	238,718	21,926	347,852	9,280	256,629
Other (including fowls).....		331,337		391,380		323,068
Total live animals.....		99,671,296		89,382,853		21,733,594
Beeswax.....pounds..	147,772	48,252	383,667	131,691	189,871	68,117
Dairy products:						
Butter.....do....	13,487,481	3,590,105	26,835,092	8,749,170	17,735,966	6,852,727
Cheese.....do....	44,394,301	7,430,089	66,050,013	15,240,033	44,330,978	10,785,153
Milk—						
Condensed.....do....	159,577,620	12,712,952	259,141,231	25,136,641	529,750,032	68,039,597
Other, including cream.....		524,426		253,629		230,920
Total dairy products, pounds.....		24,257,572		49,379,473		85,908,397
Eggs.....dozen....	26,396,206	6,134,441	24,926,424	7,568,911	18,969,167	7,167,134
Egg yolks.....do....		210,255		72,491		525,880
Feathers.....do....		312,113		368,862		302,236
Fibers, animal:						
Silk waste.....pounds..	76,596	54,017	21,782	13,418		
Wool.....do....	4,418,915	2,264,320	2,148,350	1,230,296		916,506
Total animal fibers.....	4,495,511	2,318,337	2,170,132	1,243,714	993,143	916,506
Glue.....pounds....	4,946,228	531,329	4,064,231	513,775	4,935,151	839,197
Honey.....do....		252,487		736,139	16,090,672	2,509,570

TABLE 242.—Agricultural exports (domestic) of the United States during the 3 years ending June 30, 1918—Continued.

Article exported.	Year ending June 30—					
	1916		1917		1918 (preliminary).	
	Quantity.	Value.	Quantity.	Value.	Quantity.	Value.
ANIMAL MATTER—contd.						
Packing-house products:						
Beef—						
Canned.....pounds..	50,803,765	\$9,439,066	67,536,125	\$16,946,030	97,366,983	\$30,051,507
Cured or pickled..do....	38,114,682	4,034,195	58,053,667	6,728,359	54,867,310	7,702,308
Fresh.....do.....	231,214,000	28,885,999	197,177,101	26,277,271	370,057,514	67,386,359
Oils—oleo oil.....do....	102,645,914	12,469,115	67,110,111	11,065,019	56,648,102	12,166,482
Oleomargarine.....do....	5,426,221	640,480	5,651,267	901,659	6,404,896	1,631,267
Stearin.....do.....	13,062,247	1,461,661	12,936,357	1,798,317	10,252,522	2,180,485
Tallow.....do.....	16,288,743	1,326,472	15,209,369	1,800,909	5,014,964	931,941
Total beef.....do.....	457,555,572	58,256,988	423,673,997	65,517,564	600,612,291	122,050,349
Bones and manufactures of		67,536		103,477		
Grease, grease scraps, and						
all soap stock—						
Lubricating.....		3,994,436		2,816,958		2,986,815
Soap stock.....		3,156,568		3,405,227		2,612,488
Hair.....		2,038,838		1,451,354		1,080,624
Hides and skins, other than						
furs—						
Calfskins.....pounds..	1,574,369	469,637	1,374,038	549,459	3,458,001	1,462,456
Cattle hides.....do....	13,284,190	2,938,925	7,365,461	2,041,357	7,023,761	1,953,700
Horse.....do.....	266,743	34,481	179,704	32,900	43,113	11,832
Other.....do.....	1,966,717	432,208	1,052,046	347,115	1,619,942	661,505
Total.....	17,092,019	3,875,251	9,971,249	2,970,831	12,144,817	4,089,493
Hoofs, horns, and horn		37,558		39,804		338,642
tips, strips, and waste.						
Lard compounds,						
pounds.....	52,843,311	5,147,434	56,359,493	8,269,844	31,278,383	6,613,640
Meat, canned, n. e. s.		2,835,005		4,320,652		5,683,928
Mutton.....pounds..	5,552,918	696,882	3,195,576	481,526	2,098,423	453,232
Oils, animal, n. e. s.,						
gallons.....	655,587	492,964	416,213	378,294	442,496	579,631
Pork—						
Canned.....pounds..	9,610,732	1,815,586	5,896,126	1,645,605	5,194,468	1,731,835
Cured—						
Bacon.....pounds..	579,808,786	78,615,616	667,151,972	117,221,668	815,319,424	221,477,220
Hams and shoulders,						
pounds.....	282,208,611	40,803,022	266,656,581	49,574,041	419,571,869	108,106,862
Salted or pickled,						
pounds.....	63,460,713	6,752,356	46,992,721	6,941,306	33,221,502	7,545,011
Total cured,	925,478,110	126,170,994	980,801,274	173,737,015	1,268,112,795	337,129,093
Fresh.....pounds..	63,005,524	7,523,408	50,435,615	8,875,889	21,390,302	5,225,987
Lard.....do.....	427,011,338	47,634,376	444,769,540	77,008,913	392,498,435	98,214,348
Lard, neutral.....do....	34,426,590	4,046,397	17,576,240	3,168,089	4,258,529	1,074,603
Oils—lard oil.....pounds..	3,164,768	309,836	2,469,330	321,721	686,888	126,672
gallons.....	421,969		329,244		91,585	
Total pork.....pounds..	1,462,697,062	187,500,597	1,501,948,125	264,757,232	1,692,141,417	443,502,538
Sausage and sausage						
meats—						
Canned.....pounds..	6,823,085	1,269,866	6,294,950	1,316,320	5,787,108	1,487,874
Other.....do.....	8,590,236	1,732,231	9,134,471	2,441,510	9,232,341	3,232,681
Sausage casings.....do....	14,708,893	2,867,681	6,118,060	1,741,959	6,281,086	3,039,369
All other.....		5,083,862		3,960,572		6,762,462
Total packing-house		279,053,697		363,973,124		604,513,766
products.....						
Poultry and game.....		1,561,398		1,327,348		1,241,144
Wool. (See Fibers, ani-						
mal.)						
Total animal matter.....		414,351,177		514,698,381		725,725,541

1 One gallon equals 7.5 pounds.

TABLE 242.—Agricultural exports (domestic) of the United States during the 3 years ending June 30, 1918—Continued.

Article exported.	Year ending June 30—					
	1916		1917		1918 (preliminary).	
	Quantity.	Value.	Quantity.	Value.	Quantity.	Value.
VEGETABLE MATTER.						
Breadstuffs. (See Grain and grain products.)						
Broom corn.....long tons..	3,698	\$454,749	3,218	\$684,682	3,972	\$1,293,042
Cocoa, ground or prepared, and chocolate.....		1,668,657		3,451,519		6,554,431
Coffee:						
Green or raw.....pounds..	35,333,483	5,361,055	42,916,479	6,405,837	40,905,750	5,921,883
Roasted or prepared, pounds.....	1,860,800	378,268	2,167,508	439,026	2,704,734	464,329
Total coffee.....pounds..	37,194,283	5,739,323	45,083,987	6,844,863	43,610,484	6,386,212
Cotton:						
Sea Island.....	{ bales 4,247	483,184	{ 2,311	458,728	{ 2,236	633,867
	{ pounds... 1,731,796		{ 943,864		{ 892,369	
Upland.....	{ bales 5,698,960	364,710,378	{ 5,470,150	518,505,147	{ 4,336,530	653,731,647
	{ pounds... 2,956,810,277		{ 2,850,162,770		{ 2,226,556,494	
Linters.....	{ bales 252,627	8,992,685	{ 474,704	24,110,815	{ 190,078	10,659,141
	{ pounds... 125,528,052		{ 236,974,152		{ 93,062,802	
Total cotton...do....	3,084,070,125	374,186,247	3,088,080,786	543,074,690	2,320,511,665	665,024,655
Flavoring extracts and fruit juices.....		466,914		581,550		1,018,102
Flowers, cut.....		86,407		105,615		156,559
Forest products:						
Bark, and extract of, for tanning—						
Bark.....long tons..	5,226	123,675	1,851	49,807	194	5,857
Bark, extracts of.....		5,902,799		3,908,573		3,804,563
Total bark, etc.....		6,026,474	1,851	3,958,380	194	3,810,420
Logwood extract.....		(1)		(1)		2,339,480
Charcoal.....		94,096		155,470		
Moss.....		54,720		82,881		99,793
Naval stores—						
Rosin.....barrels..	1,571,279	8,874,313	1,638,590	10,705,972	1,073,889	7,876,718
Tar, turpentine, and pitch.....barrels..	67,963	291,731	103,387	561,566	82,030	598,211
Turpentine, spirits of, gallons.....	9,310,268	4,337,563	8,841,875	4,313,670	5,100,124	2,697,305
Total naval stores..		13,503,607		15,581,208		11,172,234
Wood—						
Logs—						
Hickory.....M feet..	2,294	75,888	251	13,273	(2)	(2)
Oak.....do.....	2,019	53,668	842	27,817		
Walnut.....do.....	1,083	88,255	1,604	167,350		
Other.....do.....	38,996	757,761	48,537	784,687		
Total.....do....	44,392	975,572	51,234	993,127		
Logs and round timber—						
Fir.....M feet..	(3)	(3)	(3)	(3)	8,527	129,920
Pine, yellow.....do....					6,895	197,816
Other logs—					1,240	62,600
Hardwood.....do....						
Softwood.....do....						
Total.....do....	(3)	(3)	(3)	(3)	34,226	709,179

1 Not stated.

2 Included in Logs and round timber.

3 Included in Logs.

TABLE 242.—Agricultural exports (domestic) of the United States during the 3 years ending June 30, 1918—Continued.

Article exported.	Year ending June 30—					
	1916		1917		1918 (preliminary).	
	Quantity.	Value.	Quantity.	Value.	Quantity.	Value.
VEGETABLE MATTER—CON.						
Forest products—Contd.						
Wood—Continued.						
Lumber—						
Boards, deals, and planks—						
Cyprus.....M feet..	10,521	\$366,510	8,715	\$286,882	22,097	\$1,262,220
Fir.....do.....	268,455	2,964,948	289,980	3,763,049	274,339	6,678,416
Gum.....do.....	32,185	969,338	19,389	545,762	31,027	1,306,829
Oak.....do.....	98,990	4,665,527	54,030	2,332,739	67,216	3,374,823
Pine—						
White.....do.....	34,267	1,140,247	24,523	957,902	22,625	1,071,112
Yellow—						
Pitch pine, M feet.....	504,926	9,149,824	402,704	8,332,957	346,117	9,874,981
Short-leaf pine, M feet.....	2,185	79,147	3,042	66,028	5,657	183,367
Other pine, M feet.....	47,276	1,156,439	64,915	1,539,664	97,132	2,813,987
Poplar.....M feet..	23,356	1,044,883	7,369	324,666	19,199	1,179,859
Redwood.....do.....	38,739	1,169,975	23,289	732,672	20,964	733,176
Spruce.....do.....	37,332	1,612,892	57,497	3,150,622	72,743	6,758,438
Other.....do.....	79,099	3,649,360	86,392	5,054,797	88,669	9,072,061
Total.....do.....	1,177,331	27,969,090	1,041,845	27,087,740	1,067,785	44,309,269
Railroad ties, number.....	4,094,265	2,439,094	3,934,107	2,369,834	3,435,297	2,801,256
Shingles.....M.....	20,590	55,604	26,242	94,456	20,606	96,142
Shooks—						
Box.....do.....		1,908,643		2,029,683		2,506,722
Cooperage number.....	(1)	(1)	(1)	(1)	1,367,533	3,294,000
Other.....do.....	611,556	1,125,689	1,079,510	2,356,492	1,762,697	4,002,034
Total shoooks.....		3,034,332		4,386,175		6,508,756
Staves and heading—						
Heading.....do.....		288,587		287,174		440,525
Staves.....number..	57,537,610	3,529,181	61,469,225	3,921,882	63,207,351	3,724,895
Total and staves heading.....		3,817,768		4,209,056		4,165,420
Other.....do.....		3,393,448		2,923,712		1,966,737
Total lumber.....		40,709,336		41,070,973		59,847,580
Timber—						
Hewn.....M feet..	9,628	252,576	7,293	211,384	7,426	262,333
Sawed—						
Pitch pine...do.....	175,763	3,473,686	149,527	3,368,977	65,233	1,948,636
Other.....do.....	15,814	340,345	27,545	628,762	33,558	1,044,576
Total timber, M feet.....	201,205	4,066,607	184,365	4,209,123	106,217	3,255,545
All other, including firewood.....		164,532		203,596		277,593
Total wood.....		45,916,047		46,476,819		64,089,897
Wood alcohol....gallons..	1,472,258	857,161	823,694	645,439	2,538,001	2,070,026
Wood pulp....long tons..	² 35,994	1,703,374	² 26,019	2,018,639	² 34,805	3,531,639
Total forest products.....		68,155,479		68,918,836		87,113,489

¹ Not stated.² Long tons (2,240 pounds).

TABLE 242.—Agricultural exports (domestic) of the United States during the 3 years ending June 30, 1918—Continued.

Article exported.	Year ending June 30—					
	1916		1917		1918 (preliminary).	
	Quantity.	Value.	Quantity.	Value.	Quantity.	Value.
VEGETABLE MATTER—CON.						
Fruits:						
Fresh or dried—						
Apples, dried, pounds..	16, 219, 174	\$1, 304, 224	10, 357, 791	\$797, 487	2, 602, 590	\$330, 176
Apples, fresh, barrels..	1, 466, 321	5, 518, 772	1, 739, 997	7, 979, 236	635, 409	2, 813, 091
Apricots, dried, pounds.....	23, 939, 790	2, 168, 808	9, 841, 119	1, 298, 176	5, 175, 618	777, 780
Berries.....		639, 476		822, 977		838, 813
Lemons.....boxes..	175, 070	493, 919	174, 938	626, 270	138, 073	728, 791
Oranges.....do.....	1, 575, 042	3, 690, 080	1, 850, 372	4, 397, 067	1, 240, 477	4, 608, 048
Peaches, dried, pounds.....	13, 739, 342	893, 587	8, 187, 588	605, 620	5, 862, 605	627, 841
Pears, fresh.....		691, 732		1, 356, 259		978, 298
Prunes.....pounds..	57, 422, 827	3, 975, 396	59, 645, 141	4, 934, 329	32, 926, 546	3, 060, 691
Raisins.....do.....	75, 014, 753	5, 407, 219	51, 992, 514	4, 409, 639	54, 987, 793	4, 981, 270
Other.....do.....		3, 261, 109		3, 619, 266		4, 192, 914
Total fresh or dried.....		28, 044, 322		30, 846, 326		23, 937, 707
Preserved—						
Canned.....do.....		7, 050, 061		6, 138, 692		7, 024, 466
Other.....do.....		978, 568		413, 291		1, 255, 191
Total preserved.....		8, 028, 629		6, 551, 983		8, 279, 657
Total fruits.....		36, 072, 951		37, 398, 309		32, 217, 364
Ginseng.....pounds..	256, 082	1, 597, 508	198, 480	1, 386, 203	259, 892	1, 715, 548
Glucose and grape sugar:						
Glucose.....pounds..	148, 523, 098	3, 772, 860	170, 025, 606	5, 960, 586	80, 970, 744	4, 949, 159
Grape sugar.....do.....	37, 883, 084	962, 101	44, 947, 709	1, 398, 145	16, 887, 557	1, 045, 512
Grain and grain products:						
Grain—						
Barley.....bushels..	27, 473, 160	20, 663, 533	16, 381, 077	19, 027, 082	26, 408, 978	41, 989, 964
Buckwheat.....do.....	515, 304	481, 014	260, 102	350, 606	5, 567	10, 347
Corn.....do.....	38, 217, 012	30, 780, 887	64, 720, 842	72, 497, 204	40, 997, 827	75, 305, 692
Oats.....do.....	95, 918, 884	47, 985, 790	88, 944, 401	55, 034, 981	105, 881, 233	86, 125, 093
Rye.....do.....	14, 532, 437	15, 374, 499	13, 260, 015	21, 599, 631	12, 065, 922	24, 157, 536
Wheat.....do.....	173, 274, 015	215, 532, 681	149, 831, 427	298, 179, 705	34, 118, 853	80, 802, 542
Total grain....do....	349, 930, 812	330, 818, 404	333, 397, 864	466, 689, 209	219, 478, 380	308, 341, 174
Grain products—						
Bran and middlings, long tons.....	14, 613	432, 288	7, 428	279, 650	6, 833	286, 545
Breadstuff preparations—						
Bread and biscuit, pounds.....	11, 403, 079	787, 685	11, 766, 580	1, 115, 405	14, 917, 301	1, 973, 388
Other.....do.....		5, 074, 983		7, 721, 856		10, 452, 435
Total breadstuff preparations.....		5, 862, 668		8, 837, 261		12, 425, 823
Distillers' and brewers' grains and malt sprouts....long tons..						
Malt.....bushels..	1, 633	47, 448	1, 505	47, 809	675	26, 512
	3, 682, 248	3, 881, 700	4, 331, 297	5, 881, 287	2, 641, 270	4, 776, 847
Meal and flour—						
Corn meal....barrels..	419, 979	1, 601, 258	508, 113	2, 757, 324	2, 018, 859	20, 358, 644
Oatmeal....pounds..	54, 748, 747	1, 885, 622	110, 903, 344	4, 491, 154	346, 560, 222	17, 567, 218
Rye flour....barrels..	119, 619	646, 941	73, 914	525, 347	844, 049	9, 043, 808
Wheat flour...do....	15, 520, 669	87, 337, 805	11, 942, 778	93, 198, 474	21, 880, 151	244, 861, 140
Total meal and flour.....		91, 471, 626		100, 972, 299		291, 830, 810
Mill feed....long tons..	25, 602	801, 054	46, 112	1, 693, 752	12, 517	601, 196
All other.....do.....		1, 293, 091		1, 133, 583		5, 222, 912
Total grain products.....		103, 789, 875		118, 845, 641		315, 570, 645
Total grain and grain products.....		434, 608, 279		585, 534, 850		623, 911, 819
Hay.....long tons..	178, 336	3, 267, 028	85, 529	1, 685, 836	30, 145	907, 401
Hops.....pounds..	22, 409, 818	4, 386, 929	4, 824, 876	773, 926	3, 494, 579	993, 773
Lard compounds. (See Meat and meat products.)						

TABLE 242.—Agricultural exports (domestic) of the United States during the 3 years ending June 30, 1918—Continued.

Article exported.	Year ending June 30—					
	1916		1917		1918 (preliminary).	
	Quantity.	Value.	Quantity.	Value.	Quantity.	Value.
VEGETABLE MATTER—con.						
Liquors, alcoholic:						
Distilled spirits—						
Alcohol, including cologne spirits, proof gallons.....	24,433,243	\$8,784,742	51,941,634	\$16,027,867	8,351,142	\$4,619,878
Rum....proof gallons..	1,586,900	1,887,307	1,394,796	1,529,113	461,571	473,016
Whisky—						
Bourbon.....do....	88,802	113,863	59,611	73,942	65,955	150,208
Rye.....do....	124,700	208,879	139,619	249,572	90,386	229,016
Total whisky do....	213,502	322,742	199,230	323,514	156,341	379,224
Other.....do....	50,259	67,595	515,113	627,575	110,646	246,522
Total distilled spirits, proof gallons.....	26,283,904	11,062,386	54,050,773	18,508,069	9,079,700	5,718,640
Malt liquors—						
Bottled, dozen quarts..	674,745	969,071	966,146	1,379,921	1,013,248	1,680,745
Unbottled.....gallons..	328,229	95,556	29,237	62,104	189,434	50,414
Total malt liquors....		1,064,627		1,442,025		1,731,159
Wines.....gallons..	1,133,274	450,598	2,245,013	933,133	2,765,395	1,389,319
Total alcoholic liquors.....		12,577,611		20,883,227		8,839,118
Malt. (See Grain and grain products.)						
Malt liquors. (See Liquors, alcoholic.)						
Malt sprouts. (See Grain and grain products.)						
Nursery stock.....		203,671		220,341		260,763
Nuts:						
Peanuts.....pounds..	8,669,430	450,765	22,413,297	1,336,638	12,488,209	1,517,831
Other.....do....		441,512		403,870		745,483
Total nuts.....		892,277		1,740,508		2,263,314
Oil cake and oil-cake meal:						
Corn.....pounds..	18,996,490	297,041	15,757,612	289,547	457,584	10,246
Cottonseed:						
Cake.....do....	980,664,572	14,749,489	864,862,375	15,059,920	11,045,263	213,542
Meal.....do....	76,556,997	1,169,478	285,297,316	5,221,091	33,635,530	770,192
Flaxseed or linseed do....	640,916,196	11,935,129	536,984,394	10,252,510	151,399,977	3,895,348
Other.....do....	28,876,367	410,166	21,558,676	398,681	4,865,602	104,865
Total.....do....	1,746,010,622	28,561,303	1,724,460,373	31,221,749	201,403,956	4,994,193
Oils, vegetable:						
Fixed or expressed—						
Corn.....pounds..	2,896,826	770,076	8,779,769	998,105	1,831,114	306,219
Cottonseed.....do....	66,512,057	22,658,610	158,911,767	19,878,325	100,005,074	18,142,938
Linseed.....gallons..	714,120	478,231	1,201,554	1,117,895	1,187,850	1,532,307
Other.....do....		2,230,002		3,004,283		3,948,482
Total fixed or expressed.....		26,136,919		24,998,608		23,929,946
Volatile, or essential—						
Peppermint.....pounds..	154,096	323,070	100,032	218,627	76,247	233,899
Other.....do....		705,037		1,062,899		857,044
Total volatile, or essential.....		1,028,107		1,281,526		1,090,943
Total vegetable oils.....		27,165,026		26,280,134		25,020,889
Rice, rice meal, etc.:						
Rice.....pounds..	120,695,213	4,942,373	181,371,560	9,329,877	196,363,268	14,174,513
Rice bran, meal, and polish.....pounds..	1,272,252	10,371,857	750	14,804		
Rice hulls.....do....		857				
Total.....do....		4,953,601		9,330,695		14,174,513
Roots, herbs, and barks, n. e. s.....		768,977		852,256		784,514

TABLE 242.—Agricultural exports (domestic) of the United States during the 3 years ending June 30, 1918—Continued.

Article exported.	Year ending June 30—					
	1916		1917		1918 (preliminary).	
	Quantity.	Value.	Quantity.	Value.	Quantity.	Value.
VEGETABLE MATTER—CON.						
Seeds:						
Cotton seed.....pounds..	2,475,907	\$37,811	1,001,369	\$35,434	1,565,052	\$57,693
Flaxseed, or linseed, bushels.....	2,614	6,501	1,017	3,671	21,481	101,165
Grass and clover seed:						
Clover.....pounds..	7,116,220	1,294,944	5,886,893	1,092,515	9,439,314	2,423,776
Timothy.....do.....	13,610,257	1,038,301	15,139,913	937,820	8,520,173	748,164
Other.....do.....	3,613,026	401,925	5,666,047	701,101	3,563,556	594,053
Total grass and clover seed.....pounds..	24,339,503	2,735,170	26,692,853	2,731,436	21,523,043	3,765,993
All other seeds.....		759,026		1,231,159		1,734,312
Total seeds.....		3,538,508		4,001,700		5,659,163
Spices.....		250,827		287,484		507,712
Spirits, distilled. (See Liquors, alcoholic.)						
Starch.....pounds..	210,185,192	5,576,914	146,423,822	4,721,533	74,135,593	4,548,974
Stearin, vegetable.....do.....	1,455,341	158,481	1,321,773	179,092	1,293,327	293,591
Straw.....long tons..	980	10,989	1,097	12,948		
Sugar, molasses, and sirup:						
Molasses.....gallons..	4,387,369	524,861	2,889,991	442,967	3,811,341	847,692
Sirup.....do.....	10,031,693	2,107,068	10,327,503	4,090,150	7,690,074	4,823,912
Sugar— Refined.....pounds..	1,630,150,863	79,390,147	1,248,908,286	77,093,685	576,415,850	38,756,680
Total sugar, molasses, and sirup.....		82,022,076		81,626,802		44,428,284
Tobacco:						
Leaf.....pounds..	436,466,512	53,014,852	406,431,021	59,788,154	288,781,511	69,674,731
Stems and trimmings, pounds.....	6,826,644	350,343	5,167,839	166,153	389,282	24,994
Total.....pounds..	443,293,156	53,365,195	411,598,860	59,954,307	289,170,793	69,699,725
Vegetables:						
Fresh or dried:						
Beans and peas, bushels.....	1,760,383	5,914,198	2,164,943	10,427,742	1,783,548	10,526,385
Onions.....bushels..	563,739	578,792	409,301	749,959	534,998	793,584
Potatoes.....do.....	4,017,760	3,485,740	2,489,001	3,514,379	3,453,307	4,946,467
Total fresh or dried, bushels.....	6,341,882	9,978,730	5,063,245	14,692,080	5,771,853	16,266,436
Prepared or preserved—						
Canned.....		2,529,694		4,765,136		7,192,673
Pickles and sauces.....		1,166,811		821,151		1,084,330
Other.....		2,277,177		2,012,343		2,429,272
Total prepared or preserved.....		5,973,682		7,598,630		10,706,275
Total vegetables.....		15,952,412		22,290,710		26,972,711
Vinegar.....gallons..	225,162	33,635	284,817	47,996	292,413	73,451
Wines. (See Liquors, alco- holic.)						
Yeast.....		418,817		1,021,651		918,842
Total vegetable mat- ter, including forest products.....		1,171,875,752		1,522,473,743		1,642,726,823
Total vegetable mat- ter, excluding forest products.....		1,103,720,273		1,453,553,907		1,555,613,334
Total agricultural ex- ports, including forest products.....		1,586,226,929		2,037,172,124		2,368,452,364
Total agricultural ex- ports, excluding forest products.....		1,518,071,450		1,968,253,288		2,281,338,875

TABLE 243.—Foreign trade of the United States in agricultural products, 1852–1918.

[Compiled from reports of Foreign Commerce and Navigation of the United States. All values are gold.]

Year ending June 30—	Agricultural exports. ¹			Agricultural imports. ¹		Excess of agricultural exports (+) or of imports (—).
	Domestic.		Foreign.	Total.	Percentage of all imports.	
	Total.	Percentage of all exports.				
Average:						
1852–1856.....	\$164,895,146	80.9	\$8,059,875	\$77,847,158	29.1	+895,107,863
1857–1861.....	215,708,545	81.1	10,173,833	121,018,143	38.2	+104,864,535
1862–1866.....	118,865,540	75.7	9,287,669	122,221,547	43.0	+35,931,662
1867–1871.....	250,713,058	76.9	8,538,207	179,774,009	42.3	+79,477,159
1872–1876.....	396,666,397	78.5	8,853,247	263,155,573	46.6	+142,364,071
1877–1881.....	591,350,518	80.4	8,631,780	266,383,702	50.4	+333,598,596
1882–1886.....	557,472,922	76.3	9,340,463	311,707,564	46.8	+255,105,821
1887–1891.....	573,286,616	74.7	6,982,328	366,950,109	43.3	+213,318,835
1892–1896.....	638,748,318	73.0	8,446,491	398,332,043	51.6	+248,862,766
1897–1901.....	827,566,147	65.0	10,961,539	376,549,697	50.2	+461,977,939
1902–1906.....	879,541,247	59.5	11,922,292	487,881,038	46.3	+403,582,501
1907–1911.....	975,398,554	53.9	12,126,228	634,570,734	45.2	+352,954,048
1901.....	951,628,331	65.2	11,293,045	391,931,051	47.6	+570,990,325
1902.....	857,113,533	63.2	10,308,306	413,744,557	45.8	+453,677,282
1903.....	878,480,557	63.1	13,505,343	456,199,325	44.5	+435,786,575
1904.....	859,160,264	59.5	12,625,036	461,434,851	46.6	+410,350,439
1905.....	826,904,777	55.4	12,316,525	553,851,214	49.6	+285,370,088
1906.....	976,047,104	56.8	10,856,259	554,175,242	45.2	+432,728,121
1907.....	1,054,405,416	56.9	11,613,519	626,836,808	43.7	+439,182,127
1908.....	1,017,396,404	55.5	10,298,514	539,690,121	45.2	+488,004,797
1909.....	903,238,122	55.1	9,584,934	638,612,692	48.7	+274,210,364
1910.....	871,158,425	50.9	14,469,627	687,509,115	44.2	+198,118,937
1911.....	1,030,794,402	51.2	14,664,548	680,204,932	44.5	+365,254,018
1912.....	1,050,627,131	48.4	12,107,656	783,457,471	47.4	+279,277,316
1913.....	1,123,651,985	46.3	15,029,144	815,300,510	45.0	+323,389,919
1914.....	1,113,973,635	47.8	17,729,462	924,247,116	48.8	+207,456,481
1915.....	1,475,937,607	54.3	34,420,077	910,786,289	54.4	+599,571,395
1916.....	1,518,071,450	35.5	42,087,535	1,189,704,830	54.1	+370,454,155
1917.....	1,968,253,288	31.6	37,640,245	1,404,972,108	52.8	+600,921,425
1918 (preliminary).....	2,281,338,576	39.0	53,797,280	1,614,219,764	54.8	+720,916,392

¹ Not including forest products.

TABLE 244.—Value of principal groups of farm and forest products exported from and imported into the United States, 1916–1918.

[Compiled from reports on the Foreign Commerce of the United States.]

Article.	Exports (domestic merchandise).			Imports.		
	Year ending June 30—					
	1916	1917	1918 (prel.)	1916	1917	1918 (prel.)
FARM PRODUCTS.						
ANIMAL MATTER.						
Animals, live.....	\$99,671,296	\$89,382,853	\$21,733,594	\$18,649,079	\$16,602,859	\$21,958,378
Dairy products.....	24,257,572	49,379,473	85,908,397	9,828,919	7,071,113	8,380,393
Eggs.....	6,134,441	7,568,911	7,167,134	110,638	268,286	483,636
Feathers and downs, crude.....	312,113	368,862	302,236	2,721,151	1,479,216	1,959,180
Fibers, animal:						
Silk.....	54,017	13,418	124,333,655	160,571,808	188,454,812
Wool.....	2,264,320	1,230,296	916,506	142,420,734	131,137,170	198,545,911
Packing-house products.....	279,053,697	363,973,124	604,513,766	183,611,351	239,129,197	176,038,857
Other animal matter.....	2,603,721	2,781,444	5,183,908	2,007,174	4,203,659	6,014,767
Total animal matter.	414,351,177	514,698,381	725,725,541	484,007,241	560,463,308	601,835,934

TABLE 244.—Value of principal groups of farm and forest products exported from and imported into the United States, 1916-1918—Continued.

Article.	Exports (domestic merchandise).			Imports.		
	Year ending June 30—					
	1916	1917	1918 (prel.)	1916	1917	1918 (prel.)
FARM PRODUCTS—CON.						
VEGETABLE MATTER.						
Argols or wine lees.....				\$5,306,246	\$3,824,882	\$5,443,628
Cocoa and chocolate.....	\$1,668,657	\$3,451,519	\$6,554,431	35,804,242	40,387,418	41,372,378
Coffee.....	5,739,323	6,844,863	6,386,212	115,485,970	133,184,000	103,058,533
Cotton.....	374,186,247	543,074,690	665,024,655	40,150,342	40,429,526	36,020,483
Fibers, vegetable, other.....				59,460,062	67,709,758	109,042,470
Fruits.....	36,072,951	37,399,309	32,217,364	23,285,829	25,315,951	24,408,777
Ginseng.....	1,597,508	1,386,203	1,715,548			
Glucose and grape sugar.....	4,734,961	7,358,731	5,994,671			
Grain and grain products.....	434,608,279	585,534,850	623,911,819	15,637,360	49,396,371	76,292,626
Hay.....	3,267,028	1,685,836	907,401	679,412	628,021	4,618,764
Hops.....	4,386,929	773,926	993,773	144,627	59,291	72,450
Indigo.....				8,235,670	4,108,910	3,895,114
Licorice root.....				1,609,571	2,190,822	1,853,927
Liquors, alcoholic.....	12,577,611	20,883,227	8,839,118	16,685,356	17,679,132	11,655,093
Nursery stock (plants, trees, etc.).....	203,671	220,341	260,763	3,689,364	3,964,513	3,327,697
Nuts.....	892,277	1,740,508	2,263,314	21,172,417	32,875,686	52,847,313
Oil cake and oil cake meal.....	28,561,303	31,221,749	4,994,193	408,808	554,871	574,032
Oil, vegetable.....	27,165,026	26,280,134	25,020,890	33,933,054	47,013,967	92,323,894
Opium, crude.....				879,699	843,418	2,443,223
Rice, rice flour, meal, and broken rice.....	4,953,601	9,330,695	14,174,513	6,093,611	5,773,797	16,311,705
Sago, tapioca, etc.....				2,226,697	3,712,956	5,530,889
Seeds.....	3,538,508	4,001,700	5,659,163	33,571,760	35,879,665	50,841,623
Spices.....	250,827	287,484	507,712	8,948,729	7,745,022	11,519,214
Starch.....	5,576,914	4,721,533	4,548,974	123,838	973,530	1,673,477
Sugar, molasses, and sirup.....	82,022,076	81,626,802	44,428,284	212,545,293	241,892,265	246,193,204
Tea.....				20,599,857	19,265,264	30,889,030
Tobacco.....	53,365,195	59,954,307	69,699,725	24,629,195	25,922,655	45,320,524
Vanilla beans.....				1,697,543	1,662,578	1,475,676
Vegetables.....	15,952,412	22,290,710	26,972,711	10,811,393	29,150,889	30,175,769
Wax, vegetable.....				1,580,530	1,739,199	2,693,258
Other vegetable matter.....	2,398,969	3,485,790	4,538,101	301,114	624,443	509,051
Total vegetable mat- ter.....	1,103,720,273	1,453,554,907	1,555,613,335	705,697,589	844,508,800	1,012,383,830
Total farm products.....	1,518,071,450	1,968,253,288	2,281,338,876	1,189,704,830	1,404,972,108	1,614,219,764
FOREST PRODUCTS.						
Cork wood or cork bark.....				3,134,884	3,870,389	3,061,827
Dyewoods, and extracts of.....	(1)	(1)	2,339,480	4,289,247	4,479,195	2,238,115
Gums, rubber.....				158,586,193	193,118,855	206,543,236
Gums, other than rubber.....				14,827,537	21,510,283	22,089,638
Naval stores.....	13,503,607	15,581,208	11,172,234	8,189	8,691	
Tanning materials, n. e. s. Wood:	6,026,474	3,958,380	3,810,420	8,837,297	7,930,698	6,672,468
Cabinet, unsawed.....				4,011,107	4,266,852	5,045,463
Lumber.....	40,709,336	41,070,973	59,847,580	29,641,942	32,093,905	40,403,555
Pulp wood.....				6,373,749	6,889,123	11,088,422
Timber and logs.....	5,042,179	5,202,250	3,964,724	1,417,859	1,270,348	815,247
Rattan and reeds.....				1,720,816	1,171,052	1,781,239
Wood pulp.....	1,703,374	2,018,639	3,531,639	16,867,850	42,461,994	31,589,090
Other forest products.....	1,170,509	1,087,386	2,447,412	3,134,635	3,628,045	4,105,906
Total forest products.....	68,155,479	68,918,836	87,113,489	252,851,305	322,699,430	335,434,206
Total farm and forest products.....	1,586,226,929	2,037,172,124	2,368,452,365	1,442,556,135	1,727,671,538	1,949,653,970

(1) Not stated.

TABLE 245.—Exports of selected domestic agricultural products, 1852-1918.

[Compiled from reports of Foreign Commerce and Navigation of the United States. Where figures are lacking, either there were no exports or they were not separately classified for publication. "Beef salted or pickled," and "Pork, salted or pickled," barrels, 1851-1865, were reduced to pounds at the rate of 200 pounds per barrel, and tierces, 1855-1865, at the rate of 300 pounds per tierce; cottonseed oil, 1910, pounds reduced to gallons at the rate of 7.5 pounds per gallon. It is assumed that 1 barrel of corn meal is the product of 4 bushels of corn, and 1 barrel of wheat flour the product of 5 bushels of wheat prior to 1880 and $\frac{4}{5}$ bushels of wheat in 1880 and subsequently.]

Year ending June 30—	Cattle.	Cheese.	Packing-house products.				Beef and its total, as far as ascertain- able. ¹
			Beef, cured— salted or pickled.	Beef, fresh.	Beef oils— oleo oil.	Beef tallow.	
Average:	Number.	Pounds.	Pounds.	Pounds.	Pounds.	Pounds.	Pounds.
1852-1856	1,431	6,200,385	25,980,520			7,468,910	33,449,430
1857-1861	20,294	13,906,430	26,985,880			13,214,614	40,200,494
1862-1866	6,531	42,683,073	27,662,720			43,202,724	70,865,444
1867-1871		52,880,978	26,954,656			27,577,269	54,531,925
1872-1876	45,672	87,173,752	35,826,646			78,994,360	114,821,006
1877-1881	127,045	129,670,479	40,174,643	69,601,120		96,822,695	218,709,987
1882-1886	131,605	108,790,010	47,401,470	97,327,819	30,276,133	48,745,416	225,625,631
1887-1891	244,394	86,354,842	65,613,851	136,447,554	50,482,249	91,608,126	411,797,859
1892-1896	349,032	66,905,798	64,898,780	207,372,575	102,038,519	56,976,840	507,177,430
1897-1901	415,488	46,108,704	52,242,288	305,626,184	139,373,402	86,082,497	637,268,235
1902-1906	508,103	19,244,482	59,208,292	272,148,180	156,925,317	59,892,601	622,843,230
1907-1911	253,867	9,152,083	46,187,175	144,799,735	170,530,432	66,356,232	448,024,017
1901	459,218	39,813,517	55,312,632	351,748,333	161,651,413	77,166,889	705,104,772
1902	392,884	27,203,184	48,632,727	301,824,473	138,546,088	34,065,758	596,254,520
1903	402,178	18,987,178	52,801,220	254,795,963	126,010,339	27,368,924	546,055,244
1904	593,409	23,335,172	57,584,710	299,579,671	165,183,839	76,924,174	663,147,095
1905	567,806	10,134,424	55,934,705	236,486,568	145,228,245	63,536,992	575,874,718
1906	584,239	16,562,451	81,088,098	268,054,227	209,658,075	97,567,156	732,884,572
1907	423,051	17,285,230	62,645,281	281,651,502	195,337,176	127,857,739	689,752,420
1908	349,210	8,439,031	46,958,367	201,154,105	212,541,157	91,397,507	579,303,478
1909	207,542	6,822,842	44,494,210	122,952,671	179,985,246	53,332,767	418,844,332
1910	139,430	2,846,709	36,554,266	75,729,666	126,091,675	29,379,992	286,295,874
1911	150,100	10,366,605	40,283,749	42,510,731	138,696,906	29,813,154	265,923,983
1912	105,606	6,337,559	38,087,907	15,264,320	126,467,124	39,451,419	233,924,626
1913	24,714	2,599,058	25,856,919	7,362,388	92,849,757	30,586,350	170,208,320
1914	18,376	2,427,577	23,265,974	6,394,404	97,017,065	15,812,831	151,212,009
1915	5,484	55,362,917	31,874,743	170,440,934	80,481,946	20,239,988	394,980,962
1916	21,287	44,394,301	38,114,682	231,214,000	102,645,914	16,288,743	457,555,572
1917	13,387	66,050,013	58,053,667	197,177,101	67,110,111	15,209,369	423,673,997
1918	18,213	44,330,978	54,867,310	370,057,514	56,648,102	5,014,964	600,612,291

¹ Includes canned, cured, and fresh beef, oleo oil, oleomargarine, tallow and stearin from animal fats.

TABLE 245.—Exports of selected domestic agricultural products, 1852-1918—Contd.

Year ending June 30—	Packing-house products.					Apples, fresh.	Corn and corn meal (in terms of grain).
	Pork, cured—bacon.	Pork, cured—hams and shoulders.	Pork, cured—salted or pickled.	Pork—lard.	Pork and its products—total, as far as ascertainable. ¹		
Average:	<i>Pounds.</i>	<i>Pounds.</i>	<i>Pounds.</i>	<i>Pounds.</i>	<i>Pounds.</i>	<i>Barrels.</i>	<i>Bushels.</i>
1852-1856 ..	30,005,479	40,542,600	33,354,976	103,903,056	37,412	7,123,286
1857-1861 ..	30,583,297	34,854,400	37,965,993	103,403,690	57,045	6,557,610
1862-1866 ..	10,796,961	22,550,758	89,138,251	252,485,970	119,433	12,059,794
1867-1871 ..	45,790,113	58,879,085	53,579,373	128,488,571	9,924,235
1872-1876 ..	313,402,401	60,429,361	194,197,714	568,029,477	132,756	38,560,557
1877-1881 ..	643,633,709	85,968,138	331,457,591	1,075,793,475	509,735	88,190,030
1882-1886 ..	355,905,444	47,634,675	72,354,682	263,425,058	739,455,913	401,886	49,992,203
1887-1891 ..	419,935,416	60,697,365	73,984,682	381,388,854	936,247,966	522,511	54,606,273
1892-1896 ..	438,847,549	96,107,152	64,827,470	451,547,135	1,052,133,760	520,810	63,979,898
1897-1901 ..	536,287,266	200,853,226	112,788,498	652,418,143	1,528,138,779	779,980	192,531,378
1902-1906 ..	292,721,953	203,902,427	116,823,284	592,130,894	1,242,136,649	1,368,608	74,615,465
1907-1911 ..	209,005,144	189,603,211	90,809,879	519,746,378	1,028,996,659	1,225,655	56,568,030
1901	456,122,741	216,571,803	138,643,611	611,357,514	1,462,369,849	883,673	181,405,473
1902	383,150,624	227,653,232	115,896,275	556,840,222	1,337,315,909	459,719	28,028,688
1903	207,336,000	214,183,365	95,287,374	490,755,821	1,042,119,570	1,656,129	76,639,261
1904	249,665,941	194,948,864	112,224,861	561,302,643	1,146,255,441	2,018,222	58,222,061
1905	262,246,635	203,458,724	118,887,189	610,238,899	1,220,031,970	1,499,942	90,293,483
1906	361,210,563	194,210,949	141,820,720	741,516,886	1,464,960,356	1,208,989	119,893,833
1907	250,418,699	209,481,496	166,427,409	627,559,660	1,238,065,412	1,539,267	86,368,228
1908	241,189,929	221,769,634	149,505,937	603,413,770	1,237,210,760	1,049,545	55,063,860
1909	244,578,674	212,170,224	52,354,980	528,722,933	1,053,142,056	866,279	37,665,040
1910	152,163,107	146,885,385	40,031,599	362,927,671	707,110,062	922,078	38,128,498
1911	156,675,310	157,709,316	45,729,471	476,107,857	879,455,006	1,721,106	65,614,522
1912	208,574,208	204,044,491	56,321,469	532,255,865	1,071,951,724	1,456,381	41,797,291
1913	200,993,584	159,544,687	53,749,023	519,025,384	984,996,710	2,150,132	50,780,143
1914	193,964,252	165,881,791	45,543,085	481,457,792	921,613,029	1,506,569	10,725,819
1915	346,718,227	203,701,114	45,655,574	475,531,908	1,106,180,488	2,351,501	50,668,303
1916	579,808,786	282,208,611	63,460,713	427,011,338	1,462,697,062	1,466,321	39,896,928
1917	667,151,972	266,656,581	46,992,721	444,769,540	1,501,948,125	1,739,997	66,753,294
1918	815,319,424	419,571,869	33,221,502	392,498,435	1,692,141,417	635,409	49,073,263

Year ending June 30—	Lard com-pounds.	Cotton.	Glucose and grape sugar.	Corn-oil cake and oil-cake meal.	Cottonseed-oil cake and oil-cake meal.	Prunes.	Tobacco.
	<i>Pounds.</i>	<i>Pounds.</i>	<i>Pounds.</i>	<i>Pounds.</i>	<i>Pounds.</i>	<i>Pounds.</i>	<i>Pounds.</i>
Average:							
1852-1856	1,110,498,083	140,183,800
1857-1861	1,125,715,497	167,710,800
1862-1866	137,582,133	140,207,850
1867-1871	902,410,338	194,753,537
1872-1876	1,248,805,497	241,848,410
1877-1881	1,738,892,268	266,315,190
1882-1886	1,968,178,266	4,473,550	237,941,913
1887-1891	2,439,650,456	27,686,298	259,248,361
1892-1896	2,736,655,351	125,574,007	281,746,279
1897-1901 ..	21,792,477	3,447,909,578	209,279,772	1,005,099,895	304,401,701
1902-1906 ..	52,954,358	3,632,267,952	154,866,980	21,888,135	1,066,790,196	48,550,774	325,538,515
1907-1911 ..	75,765,254	4,004,770,051	145,064,738	61,732,807	989,738,130	47,039,287	334,395,923
1901	23,359,966	3,359,062,360	204,209,974	12,703,209	1,258,687,317	10,021,564	315,787,782
1902	36,201,744	3,528,974,636	130,419,611	14,740,498	1,050,466,246	23,358,849	301,007,365
1903	46,130,004	3,569,141,969	126,239,981	8,093,222	1,100,392,988	66,385,215	368,184,084
1904	53,603,545	3,089,855,906	152,768,716	14,014,885	820,349,073	73,146,214	311,971,831
1905	61,215,187	4,339,322,077	175,250,580	24,171,127	1,251,907,990	54,993,849	334,302,091
1906	67,621,310	3,634,045,170	189,656,011	48,420,942	1,110,834,678	24,869,744	312,227,021
1907	80,148,861	4,518,217,220	151,629,441	56,808,972	1,340,967,136	44,400,104	340,742,864
1908	75,183,210	3,816,998,693	129,686,834	66,127,704	929,287,467	28,148,540	330,812,658
1909	75,183,196	4,447,985,202	112,224,504	53,203,890	1,233,750,327	22,602,288	287,900,946
1910	74,556,603	3,206,708,226	149,820,088	49,108,598	640,088,766	89,014,880	357,196,074
1911	73,754,400	4,033,940,915	181,963,046	83,384,870	804,596,955	51,030,711	355,327,072
1912	62,522,888	5,535,125,429	171,156,259	72,490,021	1,293,690,138	74,328,074	379,845,320
1913	67,456,832	4,562,295,675	200,149,246	76,262,845	1,128,092,367	117,950,875	418,796,906
1914	58,303,564	4,760,940,538	199,530,874	59,030,623	799,974,252	69,813,711	449,749,982
1915	69,980,614	4,403,578,499	158,462,508	45,026,125	1,479,065,015	43,478,892	348,346,091
1916	52,843,311	3,084,070,125	186,406,182	18,996,490	1,057,221,569	57,422,827	443,293,156
1917	56,359,493	3,088,080,786	214,973,315	15,757,612	1,150,159,691	59,645,141	411,598,860
1918	31,278,382	2,320,511,665	97,858,301	457,584	44,680,793	32,926,546	289,170,793

¹ Includes canned, fresh, salted or pickled pork, lard, neutral lard, lard oil, bacon, and hams.

TABLE 245.—Exports of selected domestic agricultural products, 1852-1918—Contd.

Year ending June 30—	Hops.	Oils, vegetable— cotton- seed oil.	Rice and rice bran, meal, and polish.	Sugar, raw and refined.	Wheat.	Wheat flour.	Wheat and wheat flour (in terms of grain).
Average:	<i>Pounds.</i>	<i>Gallons.</i>	<i>Pounds.</i>	<i>Pounds.</i>	<i>Bushels.</i>	<i>Barrels.</i>	<i>Bushels.</i>
1352-1856.....	1,162,802	56,514,840	7,730,322	4,715,021	2,891,562	19,172,830
1857-1861.....	2,216,095	65,732,080	6,015,058	12,378,351	3,318,280	28,969,749
1862-1866.....	4,719,330	2,257,860	3,007,777	22,529,735	3,530,757	40,183,518
1867-1871.....	6,486,616	1,856,948	4,356,900	22,106,833	2,585,115	35,032,409
1872-1876.....	3,446,466	547,450	391,344	20,142,169	48,957,518	3,415,871	66,036,873
1877-1881.....	10,445,654	4,498,436	602,442	41,718,443	107,780,556	5,375,583	133,262,753
1882-1886.....	9,584,437	3,467,905	561,406	107,129,770	82,883,913	8,620,199	121,674,809
1887-1891.....	7,184,147	7,120,796	3,209,653	75,073,838	64,739,011	11,286,568	115,528,568
1892-1896.....	15,146,667	15,782,647	10,277,947	13,999,349	99,913,895	15,713,279	170,623,652
1897-1901.....	15,467,314	42,863,203	18,407,139	11,213,664	120,247,430	17,151,070	197,427,246
1902-1906.....	11,476,272	38,605,737	45,977,670	14,807,014	70,527,077	15,444,100	140,025,529
1907-1911.....	14,774,185	38,783,550	27,194,549	61,429,802	62,854,580	11,840,699	116,137,728
1901.....	14,963,676	49,356,741	25,527,846	8,874,860	132,060,667	18,650,979	215,990,073
1902.....	10,715,151	33,042,848	29,591,274	7,572,452	154,856,102	17,759,203	234,772,516
1903.....	7,794,705	35,642,994	19,750,448	10,520,156	114,181,420	19,716,484	202,905,598
1904.....	10,985,988	29,013,743	29,121,763	15,418,537	44,230,169	16,999,432	120,727,613
1905.....	14,858,612	51,535,580	113,282,760	18,348,077	4,394,402	8,826,335	44,112,910
1906.....	13,026,904	43,793,519	38,142,103	22,175,846	34,973,291	13,919,048	97,609,007
1907.....	16,809,534	41,880,304	30,174,371	21,237,603	76,569,423	15,584,667	146,700,425
1908.....	22,920,480	41,019,991	28,444,415	25,510,643	100,371,057	13,927,247	163,043,669
1909.....	10,446,884	51,087,329	20,511,429	79,946,297	66,923,244	10,521,161	114,268,468
1910.....	10,589,254	29,860,667	26,779,188	125,507,022	46,679,876	9,040,987	87,364,318
1911.....	13,104,774	30,069,459	30,063,341	54,947,444	23,729,302	10,129,435	69,311,760
1912.....	12,190,663	53,262,796	39,446,571	79,594,034	30,160,212	11,006,487	79,689,404
1913.....	17,591,195	42,031,052	38,908,057	43,994,761	91,602,974	11,394,805	141,132,166
1914.....	24,262,896	25,728,411	22,414,326	50,895,726	92,393,775	11,821,461	145,590,349
1915.....	16,210,443	42,448,870	77,480,065	549,007,411	259,642,533	16,182,765	332,464,975
1916.....	22,409,818	35,534,941	121,967,465	1,630,150,863	173,274,015	15,520,669	243,117,025
1917.....	4,824,876	21,188,236	181,372,310	1,248,908,286	149,831,427	11,942,778	203,573,928
1918.....	3,494,579	13,334,010	196,363,268	576,415,850	34,118,853	21,880,151	132,579,533

TABLE 246.—Imports of selected agricultural products, 1852-1918.

[Compiled from reports of Foreign Commerce and Navigation of the United States. Where figures are lacking, either there were no imports or they were not separately classified for publication. "Silk" includes, prior to 1881, only "Silk, raw or as reeled from the cocoon;" in 1881 and 1882 are included this item and "Silk waste;" after 1882, both these items and "Silk cocoons." From "Cocoa and chocolate" are omitted in 1860, 1861, and 1872 to 1881, small quantities of chocolate, the official returns for which were given only in value. "Jute and jute butts" includes in 1858 and 1859 an unknown quantity of "Sisal grass, coir, etc.," and in 1865-1868 an unknown quantity of "Hemp." Cattle hides are included in "Hides and skins other than cattle and goat" in 1895-1897. Olive oil for table use includes in 1862-1864 and 1885-1905 all olive oil. Sisal grass includes in 1884-1890 "Other vegetable substances." Hemp includes in 1885-1888 all substitutes for hemp.]

Year ending June 30—	Cheese.	Silk.	Wool.	Almonds.	Argols or wine lees.	Cocoa and chocolate, total.	Coffee.
Average:	<i>Pounds.</i>	<i>Pounds.</i>	<i>Pounds.</i>	<i>Pounds.</i>	<i>Pounds.</i>	<i>Pounds.</i>	<i>Pounds.</i>
1852-1856	1,053,983	19,067,447	3,460,807	2,486,572	198,582,863
1857-1861	1,378,147	3,251,091	3,063,893	216,235,090
1862-1866	2,482,063	1,354,947	2,453,141	124,551,992
1867-1871	681,669	2,360,529	3,502,614	248,726,019
1872-1876	1,094,948	4,951,473	4,857,364	307,006,928
1877-1881	1,922,269	62,744,282	12,403,256	6,315,488	384,282,199
1882-1886	4,672,846	83,293,800	17,551,967	11,568,173	529,578,782
1887-1891	8,335,323	6,564,121	117,763,889	5,860,728	21,433,570	18,322,049	509,367,994
1892-1896	9,649,752	8,382,892	162,640,491	7,487,676	26,469,990	25,475,234	597,484,217
1897-1901	12,588,515	10,962,210	163,979,079	7,361,198	24,379,847	38,209,423	816,570,082
1902-1906	22,165,754	17,187,544	193,656,402	10,920,881	27,647,440	70,901,254	980,119,167
1907-1911	37,662,812	22,143,461	199,562,649	15,297,414	29,350,692	113,673,368	934,533,322
1901	15,329,099	10,405,555	103,583,505	5,140,232	28,598,781	47,620,204	854,871,310
1902	17,067,714	14,234,826	166,576,966	9,868,982	29,276,148	52,878,587	1,091,004,252
1903	20,671,384	15,270,859	177,137,796	8,142,164	29,966,557	65,046,884	915,086,880
1904	22,707,103	16,722,709	173,742,834	9,838,852	24,571,730	75,070,746	995,043,284
1905	23,095,705	22,357,307	249,135,746	11,745,081	26,281,931	77,383,024	1,047,792,984
1906	27,286,866	17,352,021	201,688,668	15,009,326	28,140,835	84,127,027	851,668,933
1907	33,848,766	18,743,904	203,847,545	14,233,613	30,540,893	97,059,513	985,321,473
1908	32,530,830	16,662,132	125,980,524	17,144,968	26,738,834	86,604,684	890,640,057
1909	35,548,143	25,187,957	266,409,304	11,029,421	32,115,646	132,660,931	1,049,868,768
1910	40,817,524	23,457,223	263,928,232	18,556,356	28,182,956	111,070,834	871,469,516
1911	45,568,797	26,666,091	137,647,641	15,522,712	29,175,133	140,970,877	875,368,797
1912	46,542,007	26,584,962	193,400,713	17,231,458	23,661,078	148,785,846	885,201,247
1913	49,387,944	32,101,555	195,293,255	15,670,558	29,479,119	143,509,852	863,130,757
1914	63,784,313	34,545,829	247,648,869	19,038,405	29,793,011	179,364,091	1,001,528,317
1915	50,138,520	31,052,674	308,083,429	17,111,264	28,624,554	194,784,195	1,118,690,524
1916	30,087,999	41,925,297	534,828,022	16,596,921	34,721,043	245,579,101	1,201,104,485
1917	14,481,514	40,351,423	372,372,218	23,424,058	23,925,808	340,483,397	1,319,870,802
1918	9,839,305	43,282,366	379,129,934	23,840,145	30,267,388	399,312,278	1,143,890,889

Year ending June 30—	Flax.	Hemp.	Hops.	Jute and jute butts.	Licorice root.	Manila.	Molasses.
Average:	<i>Long tons.</i>	<i>Long tons.</i>	<i>Pounds.</i>	<i>Long tons.</i>	<i>Pounds.</i>	<i>Long tons.</i>	<i>Gallons.</i>
1852-1856	1,143	1,574	3,244	12,084	28,488,888
1857-1861	2,650	17,239	1,372,573	30,190,875
1862-1866	3,213	1,887,892	15,566	34,262,933
1867-1871	14,909	53,322,088
1872-1876	4,170	22,711	49,188	44,815,321
1877-1881	4,260	22,458	62,496	32,638,963
1882-1886	5,678	30,557	1,618,879	91,058	35,019,689
1887-1891	7,021	36,919	7,771,672	104,887	59,275,373	30,543,299
1892-1896	6,785	5,409	2,386,240	84,111	86,444,974	47,354	15,474,619
1897-1901	7,008	4,107	2,381,899	93,970	87,475,620	47,217	6,321,160
1902-1906	8,574	5,230	5,205,867	101,512	99,543,395	60,813	17,191,821
1907-1911	9,721	6,368	6,769,965	100,420	96,111,469	67,289	24,147,348
1901	6,878	4,057	2,606,708	103,140	100,105,654	43,735	11,453,156
1902	7,772	6,054	2,805,293	128,963	109,077,323	56,453	14,391,215
1903	8,155	4,919	6,012,510	79,708	88,580,611	61,648	17,240,399
1904	10,123	5,871	2,758,163	96,735	89,463,182	65,666	18,828,530
1905	8,089	3,987	4,339,379	98,215	108,443,892	61,562	19,477,885
1906	8,729	5,317	10,113,989	103,945	102,151,969	58,738	16,027,077
1907	8,656	8,718	6,211,893	104,489	66,115,863	54,513	24,630,935
1908	9,528	6,213	8,493,265	107,533	109,355,720	52,467	18,882,756
1909	9,870	5,208	7,386,574	156,685	97,742,776	61,902	22,082,696
1910	12,761	6,423	3,200,560	68,155	82,207,496	93,253	31,292,165
1911	7,792	5,278	8,557,531	65,239	125,135,490	74,308	23,838,190
1912	10,900	5,007	2,991,125	101,001	74,582,225	68,536	28,828,213
1913	12,421	7,663	8,494,144	125,389	105,116,227	73,823	33,926,521
1914	9,885	8,822	5,382,025	106,033	115,636,131	49,688	51,410,271
1915	4,694	5,310	11,651,332	83,140	65,958,501	51,081	70,839,623
1916	6,939	6,506	675,704	108,322	41,003,295	78,892	85,716,673
1917	7,918	9,635	236,849	112,695	59,400,224	76,765	110,237,885
1918	5,607	6,813	121,288	78,312	26,982,932	86,220	130,730,861

TABLE 246.—Imports of selected agricultural products, 1852-1918—Continued.

Year ending June 30—	Olive oil, for table use.	Opium, crude.	Potatoes.	Rice, and rice flour, rice meal, and broken rice.	Sisal grass.	Sugar, raw and refined.	Tea.
Average:	<i>Gallons.</i>	<i>Pounds.</i>	<i>Bushels.</i>	<i>Pounds.</i>	<i>Long tons.</i>	<i>Pounds.</i>	<i>Pounds.</i>
1852-1856.....	110, 143	406, 611	479, 373, 648	24, 959, 922
1857-1861.....	113, 594	691, 323, 833	28, 149, 643
1862-1866.....	177, 947	128, 590	251, 637	70, 893, 331	615	672, 637, 141	30, 869, 450
1867-1871.....	152, 827	209, 096	216, 077	52, 953, 577	1, 138, 464, 815	44, 052, 805
1872-1876.....	174, 555	365, 071	254, 615	72, 536, 435	1, 614, 055, 119	62, 436, 359
1877-1881.....	218, 507	407, 656	1, 850, 106	62, 614, 706	1, 760, 508, 290	67, 583, 083
1882-1886.....	391, 946	2, 834, 736	99, 870, 675	2, 458, 490, 409	74, 781, 418
1887-1891.....	758, 352	475, 299	3, 878, 580	156, 858, 635	40, 274	3, 003, 283, 854	84, 275, 049
1892-1896.....	773, 692	528, 785	1, 804, 649	160, 807, 652	50, 129	3, 827, 799, 481	92, 782, 175
1897-1901.....	909, 249	567, 681	495, 150	165, 231, 669	70, 297	3, 916, 433, 945	86, 809, 270
1902-1906.....	1, 783, 425	537, 576	2, 662, 121	150, 913, 684	96, 832	3, 721, 782, 404	98, 677, 584
1907-1911.....	3, 897, 224	489, 513	1, 907, 405	215, 892, 467	102, 440	3, 997, 156, 461	96, 742, 977
1901.....	983, 059	583, 208	371, 911	117, 199, 710	70, 076	3, 975, 005, 840	89, 806, 453
1902.....	1, 339, 097	534, 189	7, 656, 162	157, 658, 894	89, 583	3, 031, 915, 875	75, 579, 125
1903.....	1, 494, 132	516, 670	358, 505	169, 656, 284	87, 025	4, 216, 108, 106	108, 574, 905
1904.....	1, 713, 590	573, 055	3, 166, 581	154, 221, 772	109, 214	3, 700, 623, 613	112, 905, 541
1905.....	1, 923, 174	584, 680	181, 199	106, 483, 515	100, 301	3, 680, 932, 998	102, 706, 599
1906.....	2, 447, 131	469, 387	1, 948, 160	166, 547, 957	98, 037	3, 979, 331, 430	93, 621, 750
1907.....	3, 449, 617	565, 252	176, 917	209, 603, 180	99, 061	4, 391, 839, 975	86, 368, 490
1908.....	3, 799, 112	285, 845	403, 952	212, 783, 392	103, 994	3, 371, 997, 112	94, 149, 564
1909.....	4, 129, 454	517, 388	8, 383, 966	222, 600, 422	91, 451	4, 189, 421, 018	114, 916, 520
1910.....	3, 702, 210	449, 239	353, 208	225, 400, 545	99, 966	4, 094, 545, 936	85, 626, 370
1911.....	4, 405, 827	629, 842	218, 984	208, 774, 795	117, 727	3, 937, 978, 265	102, 563, 942
1912.....	4, 836, 515	399, 837	13, 734, 695	190, 063, 331	114, 467	4, 104, 618, 393	101, 406, 816
1913.....	5, 221, 001	508, 433	327, 230	222, 103, 547	153, 869	4, 740, 041, 488	94, 812, 380
1914.....	6, 217, 563	455, 200	3, 645, 993	300, 194, 917	215, 547	5, 066, 821, 873	91, 130, 815
1915.....	6, 710, 967	484, 027	270, 942	277, 191, 472	185, 764	5, 420, 981, 867	96, 987, 942
1916.....	7, 224, 431	146, 658	209, 532	264, 324, 005	228, 110	5, 633, 161, 749	109, 865, 935
1917.....	7, 533, 149	86, 812	3, 079, 025	216, 048, 858	143, 407	5, 332, 745, 854	103, 364, 410
1918.....	2, 537, 512	157, 834	1, 180, 480	456, 058, 608	150, 164	4, 903, 327, 249	151, 314, 932
Year ending June 30—	Beeswax.	Onions.	Plums and prunes.	Raisins.	Currants.	Dates.	Figs.
Average:	<i>Pounds.</i>	<i>Bushels.</i>	<i>Pounds.</i>	<i>Pounds.</i>	<i>Pounds.</i>	<i>Pounds.</i>	<i>Pounds.</i>
1887-1891.....	128, 790	60, 237, 642	38, 545, 635	9, 783, 650
1892-1896.....	279, 839	12, 405, 549	17, 745, 925	34, 397, 754	14, 914, 349	10, 117, 049
1897-1901.....	265, 143	628, 358	560, 762	7, 669, 593	27, 520, 440	15, 653, 642	8, 919, 921
1902-1906.....	456, 727	924, 418	563, 900	7, 344, 676	35, 457, 213	25, 649, 432	14, 334, 760
1907-1911.....	845, 720	1, 103, 034	5, 283, 145	35, 258, 628	26, 059, 353	19, 848, 037
1901.....	213, 773	774, 042	745, 974	3, 860, 836	16, 049, 198	20, 013, 681	9, 933, 871
1902.....	408, 706	796, 316	522, 478	6, 683, 545	36, 238, 976	21, 681, 159	11, 087, 131
1903.....	488, 576	925, 599	633, 819	6, 715, 675	33, 878, 209	43, 814, 917	16, 482, 142
1904.....	425, 168	1, 171, 242	494, 105	6, 867, 617	38, 347, 649	21, 058, 164	13, 178, 061
1905.....	373, 569	856, 366	671, 604	4, 041, 689	31, 742, 919	19, 257, 250	13, 364, 107
1906.....	587, 617	872, 566	497, 494	12, 414, 855	37, 078, 311	22, 435, 672	17, 562, 358
1907.....	917, 088	1, 126, 114	323, 377	3, 967, 151	38, 392, 779	31, 270, 899	24, 346, 173
1908.....	671, 526	1, 275, 333	355, 089	9, 132, 353	38, 652, 656	24, 058, 343	18, 836, 574
1909.....	764, 937	574, 530	296, 123	5, 794, 320	32, 482, 111	21, 869, 218	15, 235, 513
1910.....	972, 145	1, 024, 226	5, 042, 683	33, 326, 030	22, 693, 713	17, 362, 197
1911.....	902, 904	1, 514, 967	2, 479, 220	33, 439, 565	20, 504, 592	23, 459, 728
1912.....	1, 076, 741	1, 436, 037	3, 255, 861	33, 151, 396	25, 208, 248	18, 765, 408
1913.....	828, 793	789, 458	2, 579, 705	30, 843, 735	34, 304, 951	16, 837, 819
1914.....	1, 412, 200	1, 114, 811	4, 554, 549	32, 033, 177	34, 073, 608	19, 284, 868
1915.....	1, 564, 506	829, 177	2, 808, 806	30, 350, 527	24, 949, 374	20, 779, 730
1916.....	2, 146, 380	815, 872	1, 024, 296	25, 373, 029	31, 075, 424	7, 153, 250
1917.....	2, 685, 982	1, 757, 948	1, 850, 219	10, 476, 534	25, 485, 361	16, 479, 733
1918.....	1, 826, 618	1, 313, 402	843, 533	5, 168, 070	5, 572, 908	10, 473, 219

TABLE 246.—Imports of selected agricultural products, 1852-1918—Continued.

Year ending June 30—	Hides and skins, other than furs.			Macaroni, vermicelli, and all similar prepara- tions.	Lemons.	Oranges.	Walnuts.
	Cattle.	Goat.	Other than cattle and goat.				
Average:	<i>Pounds.</i>	<i>Pounds.</i>	<i>Pounds.</i>	<i>Pounds.</i>	<i>Pounds.</i>	<i>Pounds.</i>	<i>Pounds.</i>
1897-1901.....	126,995,011	68,052,973	91,173,311
1902-1906.....	178,681,537	93,674,819	115,952,418	153,160,863	41,104,544
1907-1911.....	94,329,840	143,351,321	99,724,072	153,343,434	12,343,790	30,980,661
1901.....	129,174,624	73,745,596	77,989,617	148,514,614	50,332,914
1902.....	148,627,907	88,038,516	89,457,680	164,075,309	52,742,476
1903.....	131,644,325	85,114,070	102,340,303	28,787,821	152,004,213	56,872,070	12,362,567
1904.....	85,370,168	86,338,547	103,024,752	40,224,202	171,923,221	35,893,260	23,670,761
1905.....	113,177,357	97,803,571	126,893,934	53,441,080	139,084,321	28,880,575	21,684,104
1906.....	156,155,300	111,097,391	158,045,419	77,926,029	138,717,252	31,134,341	24,917,028
1907.....	134,671,020	101,201,596	135,111,199	87,720,730	157,859,906	21,267,346	32,597,592
1908.....	98,353,249	63,640,758	123,770,918	97,233,708	178,490,003	18,397,429	28,887,110
1909.....	192,252,083	104,048,244	148,253,998	85,114,003	135,183,550	8,435,873	26,157,703
1910.....	318,003,538	115,844,758	174,770,732	113,772,801	160,214,785	4,676,118	33,641,466
1911.....	150,127,796	86,913,842	137,849,757	114,779,116	134,968,924	7,672,186	33,619,434
1912.....	251,012,513	95,340,703	191,414,882	108,231,028	145,639,396	7,628,662	37,213,674
1913.....	268,042,390	96,250,305	207,903,995	106,500,752	151,416,412	12,252,960	26,662,441
1914.....	279,963,488	84,759,428	196,347,770	126,128,621	37,196,728
1915.....	334,341,417	66,547,163	137,439,153	56,542,480	33,445,838
1916.....	434,177,771	100,657,021	208,835,068	21,789,602	36,858,934
1917.....	383,600,028	105,640,307	207,967,162	3,472,533	38,725,362
1918.....	267,449,770	66,932,937	98,083,986	669,524	23,289,170

TABLE 247.—Foreign trade of the United States in forest products, 1852-1918.

Compiled from reports of Foreign Commerce and Navigation of the United States. All values are gold.

Year ending June 30—	Exports.		Imports.	Excess of exports (+) or of imports (-).
	Domestic.	Foreign.		
Average:				
1852-1856.....	\$6,819,079	\$694,037	\$3,256,302	+ \$4,256,814
1857-1861.....	9,994,808	962,142	6,942,211	+ 4,014,739
1862-1866.....	7,366,103	798,076	8,511,370	- 347,191
1867-1871.....	11,775,297	690,748	14,812,576	- 2,346,531
1872-1876.....	17,906,771	959,862	19,728,458	- 861,825
1877-1881.....	17,579,313	552,514	22,006,227	- 3,874,400
1882-1886.....	24,704,992	1,417,226	34,252,753	- 8,130,535
1887-1891.....	26,060,729	1,442,760	39,647,287	- 12,143,798
1892-1896.....	29,276,428	1,707,307	45,091,081	- 14,107,346
1897-1901.....	45,960,863	3,283,274	52,326,879	- 3,082,742
1902-1906.....	63,584,670	3,850,221	79,885,457	- 12,450,566
1907-1911.....	88,764,471	6,488,455	137,051,471	- 41,798,545
1901.....	55,369,161	3,599,192	57,143,650	+ 1,824,703
1902.....	48,928,764	3,609,071	59,187,049	- 6,649,214
1903.....	58,734,016	2,865,325	71,478,022	- 9,878,681
1904.....	70,085,789	4,177,352	79,619,296	- 5,356,155
1905.....	63,199,348	3,790,097	92,680,555	- 25,691,110
1906.....	76,975,431	4,809,261	96,462,364	- 14,677,672
1907.....	92,948,705	5,500,331	122,420,776	- 23,971,740
1908.....	90,362,073	4,570,397	97,733,092	- 2,800,622
1909.....	72,442,454	4,982,810	123,920,126	- 46,494,862
1910.....	85,030,230	9,801,881	178,871,797	- 84,039,686
1911.....	103,038,892	7,586,854	162,311,565	- 51,685,819
1912.....	108,122,254	6,413,343	172,523,465	- 57,987,868
1913.....	124,835,784	7,431,851	180,502,444	- 48,234,809
1914.....	106,978,554	4,517,766	155,261,300	- 43,764,980
1915.....	52,553,536	5,089,299	165,849,493	- 108,206,658
1916.....	68,155,479	4,364,335	252,851,305	- 180,331,491
1917.....	68,918,836	11,171,520	322,099,430	- 242,609,074
1918 (preliminary).....	87,113,489	6,066,140	335,434,206	- 242,254,577

TABLE 248.—Exports of selected domestic forest products, 1852–1918.

[Compiled from reports of Foreign Commerce and Navigation of the United States. Where figures are lacking, either there were no exports or they were not separately classified for publication.]

Year ending June 30—	Lumber.			Rosin.	Spirits of turpentine.	Timber.	
	Boards, deals, and planks. ¹	Shooks, other than box.	Staves.			Hewn.	Sawed.
Average:	<i>M feet.</i>	<i>Number.</i>	<i>Number.</i>	<i>Barrels.</i>	<i>Gallons.</i>	<i>Cubic feet.</i>	<i>M feet.</i>
1851–1856	129,499	552,210	1,369,250
1857–1861	205,476	664,206	2,735,104
1862–1866	138,020	69,314	102,162
1867–1871	138,720	491,774	2,693,412
1872–1876	221,658	845,803	17,459,632
1877–1881	303,114	7,138,556	18,316,876
1882–1886	433,963	1,289,869	9,301,894	13,701,663
1887–1891	531,755	593,054	1,533,834	10,794,025	6,401,543	218,796
1892–1896	6,6,090	435,581	2,006,427	14,258,928	6,062,418	263,641
1897–1901	957,218	668,797	2,477,696	18,349,388	5,146,927	428,755
1902–1906	212,476	765,215	51,234,056	2,453,280	16,927,090	3,968,469	508,212
1907–1911	1,649,203	925,828	56,181,900	2,355,560	16,658,955	3,406,245	479,776
1901	1,101,815	714,651	47,363,262	2,820,815	20,240,851	4,642,698	533,920
1902	942,814	788,241	46,998,512	2,535,962	19,177,788	5,388,439	412,750
1903	1,065,771	566,205	55,879,010	2,396,498	16,378,787	3,291,498	530,659
1904	1,426,784	533,182	47,420,095	2,585,108	17,202,808	3,788,740	558,690
1905	1,283,406	872,192	48,286,285	2,310,275	15,894,813	3,856,623	486,411
1906	1,343,607	1,066,253	57,586,378	2,438,556	15,981,253	3,517,046	552,548
1907	1,623,964	803,346	51,120,171	2,560,966	15,854,676	3,278,110	600,855
1908	1,548,130	900,812	61,696,949	2,712,732	19,532,583	4,883,506	463,440
1909	1,357,822	977,376	52,583,016	2,170,177	17,502,028	2,950,528	383,309
1910	1,684,489	928,197	49,783,771	2,144,318	15,587,737	3,245,196	451,721
1911	2,031,608	1,019,411	65,725,595	2,189,607	14,817,751	2,673,887	499,547
1912	2,306,680	1,161,591	64,162,599	2,474,460	19,599,241	<i>M feet.</i> 31,067	406,954
1913	2,550,308	1,710,095	89,005,624	2,806,046	21,093,597	34,502	477,135
1914	2,405,296	867,805	77,150,535	2,417,950	18,900,704	29,859	411,337
1915	1,129,205	620,043	39,297,268	1,372,316	9,464,120	6,118	167,671
1916	1,177,331	611,556	57,537,610	1,571,279	9,310,268	9,628	191,577
1917	1,041,845	1,079,510	61,459,225	1,638,590	8,841,875	7,293	177,072
1918	1,067,785	1,762,697	63,207,351	1,073,889	5,100,124	7,426	98,791

¹ Including "Joists and scantling" prior to 1884.

TABLE 249.—Imports of selected forest products, 1852–1918.

Year ending June 30—	Camphor, crude.	India rubber.	Rubber gums, total.	Lumber.		Shellac.	Wood pulp.
				Boards, deals, planks, and other sawed.	Shingles.		
Average:	<i>Pounds.</i>	<i>Pounds.</i>	<i>Pounds.</i>	<i>M feet.</i>	<i>M.</i>	<i>Pounds.</i>	<i>Longtons.</i>
1852–1856	213,720
1857–1861	360,522
1862–1866	386,731	634,276
1867–1871	17,389,980
1872–1876	12,631,388	564,612	88,197
1877–1881	1,515,614	15,610,634	417,907	55,394
1882–1886	1,958,608	24,480,997	577,728	87,760
1887–1891	2,273,883	33,226,520	646,745	184,050	5,086,421	37,251
1892–1896	1,491,902	38,359,547	39,671,553	661,495	5,848,339	42,771
1897–1901	1,858,018	47,469,136	52,974,744	566,394	8,839,232	46,827
1902–1906	2,139,183	57,903,641	75,908,633	727,205	772,340	11,613,967	120,764
1907–1911	2,939,167	80,129,567	121,504,098	899,659	866,565	19,046,030	319,007
1901	2,175,784	55,275,529	64,927,176	490,820	555,853	9,608,745	46,757
1902	1,831,058	50,413,481	67,790,069	665,603	707,614	9,064,789	67,416
1903	2,472,440	55,010,571	69,311,678	720,937	724,131	11,590,725	116,881
1904	2,819,673	59,015,551	74,327,584	589,232	770,373	10,933,413	144,796
1905	1,904,002	67,234,256	87,004,384	710,538	758,725	10,700,817	167,504

¹ Includes "Gutta-percha" only, for 1867.

TABLE 249.—Imports of selected forest products, 1852-1918—Continued.

Year ending June 30—	Camphor, crude.	India rubber.	Rubber gums, total.	Lumber.		Shellac.	Wood pulp.
				Boards, deals, planks, and other sawd.	Shingles.		
	<i>Pounds.</i>	<i>Pounds.</i>	<i>Pounds.</i>	<i>M feet.</i>	<i>M.</i>	<i>Pounds.</i>	<i>Longtons.</i>
1906.....	1,668,744	1 57,844,345	81,109,451	949,717	900,856	15,780,090	157,224
1907.....	3,138,070	1 76,963,838	106,747,589	934,195	881,063	17,785,960	213,110
1908.....	2,814,299	1 62,233,160	85,809,625	791,288	988,081	13,361,932	237,514
1909.....	1,990,499	1 88,359,895	114,598,768	846,024	1,058,363	19,185,137	274,217
1910.....	3,006,648	1 101,044,681	154,620,629	1,054,416	672,798	29,402,182	378,322
1911.....	3,726,319	1 72,046,260	145,743,880	872,374	642,582	15,494,940	491,873
1912.....	2,154,646	110,210,173	175,965,538	905,275	514,657	18,745,771	477,508
1913.....	3,709,264	113,384,359	170,747,339	1,090,628	560,297	21,912,015	502,913
1914.....	3,476,908	131,995,742	161,777,250	928,873	895,038	16,719,756	508,360
1915.....	3,729,207	172,068,428	196,121,979	939,322	1,487,116	24,153,363	587,922
1916.....	4,574,430	267,775,557	304,182,814	1,218,068	1,769,333	25,817,509	507,048
1917.....	6,884,950	333,373,711	364,913,711	1,175,180	1,924,139	32,539,522	699,475
1918.....	3,638,384	389,599,015	414,983,610	1,282,747	1,878,465	22,913,256	504,108

¹ Includes "Guayule gum." crude.

TABLE 250.—Principal farm products imported from specified countries into the United States, 1910-1918.

Country of origin and article.	Year ending June 30—					
	Average, 1910-1914		1917		1918 (preliminary).	
	Quantity.	Value.	Quantity.	Value.	Quantity.	Value.
Brazil:						
Cocoa (crude).....pounds..	17,128,176	\$1,775,492	51,461,624	\$4,959,964	91,351,529	\$8,383,383
Coffee.....do.....	673,058,602	73,384,467	907,197,562	85,761,395	743,958,456	60,888,926
British West Indies:						
Bananas.....bunches..	14,404,120	4,309,165	2,191,516	677,129	2,049,655	721,516
Cocoa.....pounds..	36,119,338	4,241,927	60,139,918	7,323,005	51,438,970	6,295,562
Canada: Tea.....do.....	2,787,373	749,212	3,160,459	1,084,134	1,914,169	647,712
China: Tea.....do.....	22,932,930	2,898,239	19,810,428	3,109,912	21,082,866	4,361,557
Colombia: Coffee.....do.....	70,516,164	7,849,476	150,591,659	17,971,874	112,159,390	13,108,462
Cuba:						
Bananas.....bunches..	2,388,024	873,773	2,184,110	837,251	1,151,165	482,046
Sugar (raw).....pounds..	3,856,447,356	91,686,167	4,669,097,398	204,521,160	4,560,749,643	219,461,319
Dominican Republic: Cocoa,.....pounds..	24,818,840	2,705,639	61,443,869	7,202,747	39,851,184	3,660,091
.....do.....	19,120,725	1,910,516	67,227,698	8,178,778	76,786,657	7,975,868
Ecuador: Cocoa.....do.....	4,142,716	838,855	1,937,341	754,012	1,026,117	528,926
.....do.....	864,796	1,420,744	726,771	1,211,731	227,617	576,602
France:						
Cheese.....do.....	4,142,716	838,855	1,937,341	754,012	1,026,117	528,926
Olive oil (salad).....gallons..	864,796	1,420,744	726,771	1,211,731	227,617	576,602
Italy:						
Cheese.....pounds..	20,884,962	3,949,536	8,482,280	2,545,286	16,044	7,883
Macaroni.....do.....	1,905,642	4,793,902	2,431,910	191,845
Olive oil (salad).....gallons..	3,293,221	4,264,153	2,882,535	4,770,315	200,403	467,692
Japan: Tea.....pounds..	46,245,473	7,957,043	52,418,963	8,825,089	52,996,471	9,511,283
Mexico: Coffee.....do.....	31,220,334	4,522,481	54,908,223	6,382,845	31,118,513	3,336,131
Netherlands:						
Cheese.....do.....	3,365,038	431,208	249,371	68,645
Coffee.....do.....	2,565,776	414,635	150,000	18,090
Philippine Islands: Sugar.....pounds..	232,340,306	5,827,471	267,891,954	8,382,562	173,600,941	7,913,247
Portugal: Cocoa.....pounds..	18,751,436	2,167,085	16,551,624	2,148,191	134,904	20,912
Spain:						
Olive oil (salad).....gallons..	292,433	281,799	3,776,581	4,350,747	2,091,400	2,783,691
Goat skins.....pounds..	442,721	177,290	1,869,360	1,621,021	806,152	845,714
Switzerland: Cheese pounds..	16,924,388	2,957,924	1,640,656	341,063
United Kingdom:						
Cocoa.....pounds..	8,534,723	1,065,997	11,650,811	1,460,314	1,038,142	113,304
Tea.....do.....	11,620,192	3,180,509	13,857,721	3,309,507	487,063	248,678

TABLE 251.—Principal farm products exported to specified countries from the United States, 1910-1918.

Country to which consigned, and article.	Year ending June 30—					
	Average 1910-1914		1917		1918 (preliminary).	
	Quantity.	Value.	Quantity.	Value.	Quantity.	Value.
Belgium:						
Corn..... bushels..	1,387,953	\$549,230	581,371	\$590,771	3,714,233	\$7,277,381
Wheat..... do.....	7,195,158	7,135,039	2,698,044	4,887,416	6,007,986	13,674,261
Bacon..... pounds..	4,901,373	663,563	65,219,598	8,508,658	68,670,327	17,200,008
Hams and shoulders.. do..	7,863,470	920,349				
Lard..... do.....	17,076,171	1,851,624	96,761,185	13,815,450	116,154,490	28,105,585
Brazil: Wheat flour... barrels..	567,444	3,016,124	301,614	2,743,818	101,927	1,149,284
Canada:						
Corn..... bushels..	8,379,334	5,200,422	15,724,838	16,158,665	7,895,892	13,127,564
Wheat..... do.....	1,776,249	1,752,052	4,714,836	9,856,529	252,540	577,965
Wheat flour..... barrels..	82,821	366,887	77,115	580,326	83,534	884,042
Bacon..... pounds..	4,964,662	752,788	118,709,847	21,366,115	42,837,136	11,744,199
Hams and shoulders.. do..	4,509,867	697,450	5,617,090	1,021,892	14,286,628	3,787,253
Lard..... do.....	10,181,941	1,179,912	5,375,768	984,930	893,977	208,131
Pork, pickled..... do..	10,117,759	1,036,146	16,929,411	2,501,890	13,689,396	3,065,724
China: Wheat flour... barrels..	263,882	1,022,283	9,406	44,532		
Cuba:						
Corn..... bushels..	2,300,521	1,640,115	2,819,278	2,948,100	1,142,293	2,094,937
Wheat flour..... barrels..	856,239	4,245,858	1,016,675	8,661,925	679,689	7,733,557
Bacon..... pounds..	7,696,815	909,780	14,914,902	2,533,943	20,318,559	5,524,695
Hams and shoulders.. do..	4,696,184	716,914	9,867,826	1,880,230	9,990,141	2,669,458
Lard..... do.....	41,378,503	4,600,802	43,732,924	8,819,512	52,566,358	14,334,719
Pork, pickled..... do..	7,286,791	753,446	7,700,421	1,145,958	8,935,072	2,148,796
Denmark: Corn..... bushels..	2,493,820	1,490,253	7,075,254	9,205,072		
Finland: Wheat flour. barrels..	¹ 304,820	¹ 1,529,806				
France:						
Wheat..... bushels..	3,001,698	2,978,569	16,253,262	31,698,762	3,837,927	9,428,203
Bacon..... pounds..	2,689,203	285,392	77,035,622	12,062,410	73,531,892	19,301,977
Lard..... do.....	12,089,618	1,236,056	54,967,832	10,712,463	33,427,329	8,603,286
Germany:						
Corn..... bushels..	5,231,554	3,245,265				
Wheat..... do.....	6,154,503	6,087,881				
Wheat flour..... barrels..	187,457	990,535				
Lard..... pounds..	142,311,431	15,683,461				
Lard, neutral..... do..	¹ 19,228,140	¹ 1,011,695				
Oleo oil..... do.....	¹ 20,068,668	¹ 2,110,895				
Hongkong: Wheat flour						
..... barrels..	1,121,139	4,441,122	61,800	306,756	1,250	13,825
Italy:						
Wheat..... bushels..	2,367,307	2,411,343	13,746,512	26,743,498	6,756,191	15,579,424
Lard..... pounds..	4,655,944	491,796	4,981,846	1,058,998	2,136,645	503,717
Japan: Wheat flour... barrels..	612,879	2,368,658	4,083	35,652		
Mexico:						
Corn..... bushels..	2,500,803	1,811,391	2,530,699	3,133,896	3,272,754	6,871,144
Wheat..... do.....	1,178,864	1,203,590	54,597	83,535		
Lard..... pounds..	7,000,932	795,362	13,261,559	2,270,025	6,957,993	1,625,892
Netherlands:						
Corn..... bushels..	5,111,282	3,177,689	7,923,706	8,237,912	246,004	456,009
Wheat..... do.....	8,350,709	8,244,445	19,127,675	37,946,031	155,550	380,224
Wheat flour..... barrels..	818,637	4,289,933	591,182	4,087,784	69,253	690,141
Bacon..... pounds..	4,408,989	518,655	10,625,101	1,501,376		
Lard..... do.....	36,501,329	4,052,282	20,446,110	2,838,460		
Lard, neutral..... do..	¹ 25,078,158	¹ 2,728,676	2,657,914	432,566		
Oleo oil..... do.....	¹ 57,484,122	¹ 6,026,397	8,081,795	1,201,373		
Norway: Oleo oil..... do..	8,335,573	890,069	15,907,144	2,745,117	774,004	175,106
Philippine Islands: Wheat flour						
..... barrels..	278,717	1,126,241	76,089	420,480	549	5,442
United Kingdom:						
Corn..... bushels..	10,906,171	6,804,769	24,493,817	27,860,538	21,197,784	39,118,255
Wheat..... do.....	21,806,112	20,463,483	67,976,120	139,429,196	15,129,803	36,470,014
Wheat flour..... barrels..	2,712,639	13,752,657	3,015,525	21,947,731	10,055,827	112,664,938
Bacon..... pounds..	133,760,286	17,202,207	346,758,407	65,192,174	533,135,385	147,983,735
Hams and shoulders.. do..	143,087,022	18,430,974	217,434,561	40,800,138	372,722,508	95,792,492
Lard..... do.....	169,716,230	18,403,258	178,110,633	32,816,184	159,959,165	38,855,685
Oleo oil..... do.....	¹ 7,150,505	¹ 994,832	31,761,124	5,316,644	48,244,317	10,184,472
Pork, pickled..... do..	10,225,205	1,154,646	6,058,672	929,881	1,903,144	447,141

¹ Four-year average, 1911-1914.

TABLE 252.—Shipments of principal domestic farm and forest products from the United States to Hawaii and Porto Rico, 1916-1918.

[These shipments are not included in the domestic exports from or imports into the United States.]

Possession and article.	Year ending June 30—					
	1916		1917		1918	
	Quantity.	Value.	Quantity.	Value.	Quantity.	Value.
HAWAII.						
Dairy products.....pounds..	4, 819, 844	\$629, 825	5, 537, 968	\$878, 816	4, 057, 847	\$878, 447
Meat products.....		883, 174		1, 165, 817		740, 107
Grain and grain products.....		2, 322, 166		3, 142, 022		3, 039, 729
Rice.....pounds..	191, 840	7, 307	5, 918, 689	267, 423	8, 651, 147	594, 698
Lumber.....		1, 002, 976		1, 638, 887		1, 494, 241
PORTO RICO.						
Dairy products.....pounds..	3, 861, 569	496, 177	4, 346, 394	652, 888	5, 692, 110	1, 062, 646
Meat products.....		3, 551, 176		4, 311, 385		5, 011, 966
Beans and dried peas..bushels..	216, 747	795, 276	211, 542	964, 072	218, 608	1, 259, 334
Grain and grain products.....		2, 994, 388		4, 086, 369		4, 310, 180
Rice.....pounds..	143, 171, 261	5, 596, 068	154, 806, 589	6, 587, 122	125, 131, 832	9, 144, 940
Sugar.....do.....	10, 265, 579	612, 041	9, 331, 896	670, 530	3, 017, 215	245, 074
Tobacco.....do.....	1, 764, 344	285, 041	2, 376, 479	432, 453	2, 003, 224	637, 872
Lumber.....		756, 434		1, 294, 561		1, 074, 992

TABLE 253.—Shipments of principal domestic farm products from Hawaii and Porto Rico to the United States, 1916-1918.

Possession and article.	Year ending June 30—					
	1916		1917		1918	
	Quantity.	Value.	Quantity.	Value.	Quantity.	Value.
HAWAII.						
Coffee.....pounds..	2, 252, 364	\$343, 829	1, 987, 035	\$297, 972	1, 968, 080	\$275, 733
Pineapples, canned.....		6, 547, 055		7, 970, 522		8, 394, 307
Sugar.....pounds..	1, 137, 159, 828	54, 418, 095	1, 162, 605, 056	62, 741, 164	1, 080, 908, 797	64, 108, 540
PORTO RICO.						
Grapefruit.....boxes..	296, 613	836, 932	435, 890	939, 677	549, 825	1, 120, 330
Oranges.....do.....	404, 367	790, 667	502, 313	1, 008, 465	602, 987	1, 230, 984
Pineapples.....		1, 176, 319		916, 415		617, 496
Molasses and sirup..gallons..	16, 279, 073	1, 073, 786	18, 751, 212	1, 332, 538	14, 495, 752	1, 213, 382
Sugar.....pounds..	849, 763, 491	45, 799, 299	977, 377, 996	53, 987, 767	672, 937, 334	41, 310, 845
Tobacco, leaf.....do.....	6, 705, 823	2, 857, 036	7, 958, 439	3, 583, 052	13, 124, 315	7, 913, 675

TABLE 254.—Destination of principal farm products exported from the United States, 1910-1918.

Article, and country to which consigned.	Quantity.				Per cent of total.			
	Year ending June 30—							
	Average, 1910-1914.	1916	1917	1918 (prel.).	Average, 1910-1914.	1916	1917	1918 (prel.).
ANIMAL MATTER.								
Cattle:	<i>Number.</i>	<i>Number.</i>	<i>Number.</i>	<i>Number.</i>				
Canada.....	9,105	4,511	6,382	10.4	21.2	47.7
Mexico.....	7,341	3,990	4,324	8.4	18.7	32.3
United Kingdom.....	66,422	815	75.8	3.8
Other countries.....	4,757	11,971	2,681	5.4	56.3	20.0
Total.....	87,625	21,287	13,387	18,213	100.0	100.0	100.0	100.0
Horses:								
Canada.....	24,486	82,311	28,546	18,064	87.2	23.0	10.2	21.3
Cuba.....	1,212	630	1,000	4.3	.2	.4
Mexico.....	1,197	4,661	2,659	4,775	4.3	1.3	1.0	5.6
United Kingdom.....	522	49,412	100,110	56,215	1.9	13.8	35.9	66.3
Other countries.....	656	220,539	146,359	5,711	2.3	61.7	52.5	6.8
Total.....	28,073	357,553	278,674	84,765	100.0	100.0	100.0	100.0
Butter:	<i>Pounds.</i>	<i>Pounds.</i>	<i>Pounds.</i>	<i>Pounds.</i>				
Canada.....	499,942	2,013,392	1,323,653	44,749	11.7	14.9	4.9	.3
Central American States and British Honduras.....	694,345	834,385	814,396	16.2	6.2	3.0
Mexico.....	369,271	107,395	558,369	223,091	8.6	1.2	2.1	1.3
United Kingdom.....	601,095	5,433,282	20,839,583	13,982,559	14.1	40.3	77.7	78.8
Venezuela.....	599,600	38,663	79,785	14.0	.3	.3
West Indies and Bermuda.....	1,361,406	1,614,695	1,829,040	1,197,180	31.8	12.0	6.8	6.8
Other countries.....	152,296	3,385,669	1,390,266	2,288,387	3.6	25.1	5.2	12.8
Total.....	4,277,955	13,487,481	26,835,092	17,735,906	100.0	100.0	100.0	100.0
Meat products:								
Beef products—								
Beef, canned—								
United Kingdom.....	5,129,188	38,205,216	40,218,190	46,375,149	54.6	75.2	59.6	47.6
Other countries.....	4,262,934	12,598,549	27,317,935	50,991,834	45.4	24.8	40.4	52.4
Total.....	9,392,122	50,803,765	67,536,125	97,366,983	100.0	100.0	100.0	100.0
Beef, fresh—								
Panama.....	5,026,662	1,504,583	235,034	144,442	17.1	.7
United Kingdom.....	23,410,437	117,409,488	125,687,523	285,789,315	79.5	50.8	63.7	77.2
Other countries.....	1,015,203	112,299,929	71,254,544	84,123,757	3.4	48.5	36.2	22.8
Total.....	29,452,302	231,214,000	197,177,101	370,057,514	100.0	100.0	100.0	100.0
Beef, pickled and other cured—								
Canada.....	1,386,090	5,101,349	9,394,712	2,623,317	4.2	13.4	16.2	4.8
Germany.....	3,617,862	400	11.0
Newfoundland and Labrador.....	4,941,896	5,027,163	6,802,524	5,505,008	15.1	13.2	11.7	10.0
United Kingdom.....	7,902,166	12,003,390	7,489,665	4,205,294	24.1	31.5	12.9	7.7
West Indies and Bermuda.....	4,548,476	2,372,514	1,868,094	2,026,658	13.9	6.2	3.2	3.7
Other countries.....	10,413,273	13,609,866	32,498,672	40,507,033	31.7	35.7	56.0	73.8
Total.....	32,809,763	38,114,682	58,053,667	54,867,310	100.0	100.0	100.0	100.0
Oleo oil²—								
Denmark.....	5,714,442	6,614,373	2,764,095	30,000	5.0	6.4	4.1	.1
Germany.....	20,068,668	17.6
Netherlands.....	57,084,122	29,762,451	8,081,795	50.2	29.0	12.0
Norway.....	8,335,573	14,062,716	15,907,144	774,004	7.3	13.7	23.7	1.4
Sweden.....	2,350,272	9,234,361	2,247,553	13,313	2.1	9.0	3.3
Turkey in Europe.....	3,869,784	3.4
United Kingdom.....	9,117,005	30,657,569	31,761,124	48,244,317	8.0	29.9	47.3	85.2
Other countries.....	7,217,847	12,314,444	6,348,400	7,586,468	6.4	12.0	9.6	13.3
Total.....	113,757,713	102,645,914	67,110,111	56,648,102	100.0	100.0	100.0	100.0

¹ Bermuda included in "other countries." ² For "Oleo oil" the average is for 4 years 1911-1914.

TABLE 254.—Destination of principal farm products exported from the United States, 1910-1918—Continued.

Article, and country to which consigned.	Quantity.				Per cent of total.			
	Year ending June 30—							
	Average, 1910-1914.	1916	1917	1918 (prel.).	Average, 1910-1914.	1916	1917	1918 (prel.).
ANIMAL MATTER—con.								
Meat products—Contd.								
Lard compounds—								
Cuba.....	19,793,565	11,895,209	14,164,676	7,735,338	29.4	22.5	25.1	24.7
Mexico.....	5,399,201	4,597,585	6,863,487	4,441,734	8.0	8.7	12.2	14.2
United Kingdom.....	20,830,150	18,486,477	13,507,936	4,416,476	30.9	35.0	24.0	14.1
Other countries.....	21,295,941	17,864,049	21,823,394	14,684,834	31.7	33.8	38.7	47.0
Total.....	67,318,857	52,843,311	56,359,493	31,278,382	100.0	100.0	100.0	100.0
Pork products—								
Bacon—								
Belgium.....	4,901,373	60,160,749	65,219,598	68,670,327	2.7	10.4	9.8	8.4
Canada.....	4,964,662	39,590,591	118,709,847	42,837,136	2.7	6.8	17.8	5.3
Cuba.....	7,696,815	13,543,082	14,914,902	20,318,559	4.2	2.3	2.2	2.5
France.....	2,689,203	52,501,448	77,035,622	73,531,892	1.5	9.1	11.5	9.0
Italy.....	7,560,557	10,532,169	19,373,346	74,459,980	4.1	1.8	2.9	9.1
Netherlands.....	4,408,989	12,846,176	10,625,101	2.4	2.2	1.6
Norway.....	3,637,518	22,386,900	8,296,500	25,243	2.0	3.9	1.2
Sweden.....	1,909,280	14,906,277	1,065,440	48	1.0	2.6	.2
United Kingdom.....	133,760,286	339,341,069	346,758,407	533,135,385	73.3	58.5	52.0	65.4
Other countries.....	10,945,409	14,000,325	5,148,209	2,340,854	6.1	2.4	.8	.3
Total.....	182,474,092	579,808,786	667,151,972	815,319,424	100.0	100.0	100.0	100.0
Hams and shoulders, cured—								
Belgium.....	7,863,470	2,792,605	4.7	1.0
Canada.....	4,509,867	2,673,658	5,617,090	14,286,628	2.7	.9	2.1	3.4
Cuba.....	4,696,184	11,493,464	9,867,826	9,990,141	2.8	4.1	3.7	2.4
United Kingdom.....	143,087,022	251,025,755	217,434,561	372,722,508	85.8	89.0	81.5	88.8
Other countries.....	6,656,591	14,223,129	33,737,104	22,572,592	4.0	5.0	12.7	5.4
Total.....	166,813,134	282,208,611	266,556,581	419,571,869	100.0	100.0	100.0	100.0
Lard—								
Belgium.....	17,076,171	70,132,156	96,761,185	116,154,490	3.6	16.4	21.8	29.6
Canada.....	10,181,941	6,330,140	5,375,768	893,977	2.1	1.5	1.2	.2
Cuba.....	41,378,503	53,811,784	48,732,924	52,566,358	8.7	12.6	11.0	13.4
Denmark.....	2,480,647	2,874,017	841,110	75,000	.5	.7	.2
Ecuador.....	3,369,460	3,716,378	3,842,692	1,810,527	.7	.9	.9	.5
France.....	12,089,618	42,282,883	54,967,832	33,427,329	2.5	9.9	12.4	8.5
Germany.....	142,311,431	30.0
Italy.....	4,655,944	3,487,719	4,981,846	2,136,645	1.0	.8	1.1	.5
Mexico.....	7,000,932	8,736,712	13,261,559	6,957,993	1.5	2.0	3.0	1.8
Netherlands.....	36,501,329	13,281,671	20,446,110	7.7	3.1	4.6
Peru.....	2,784,573	2,265,865	2,082,555	1,400,455	.6	.5	.5	.4
United Kingdom.....	169,176,230	192,075,591	178,110,633	159,959,165	35.7	45.0	40.0	40.8
Other countries.....	25,348,135	28,016,422	15,365,326	17,116,496	5.4	6.6	3.3	4.3
Total.....	474,354,914	427,011,338	444,769,540	392,498,435	100.0	100.0	100.0	100.0
Lard, neutral—								
Denmark.....	2,250,893	2,078,710	1,022,499	5.2	6.0	5.8
Germany.....	9,228,140	21.2
Netherlands.....	25,078,158	9,059,503	2,657,914	57.6	26.3	15.1
Norway.....	2,679,054	2,222,742	3,234,094	322,932	6.1	6.5	18.4	7.6
United Kingdom.....	1,871,448	12,114,029	8,627,547	3,495,665	4.3	35.2	49.1	82.1
Other countries.....	2,463,857	8,951,606	2,034,186	439,932	5.6	26.0	11.6	10.3
Total.....	43,571,550	34,426,590	17,576,240	4,258,529	100.0	100.0	100.0	100.0
Pork, pickled—								
British Guiana.....	1,539,772	877,977	1,083,300	863,280	3.2	1.4	2.3	2.6
Canada.....	10,117,759	17,835,273	16,929,411	13,689,396	21.0	28.1	36.0	41.2
Cuba.....	7,286,791	7,846,918	7,700,421	8,935,072	15.1	12.4	16.4	26.9
Haiti.....	1,818,119	949,492	772,310	3.8	1.5	1.6
Newfoundland and Labrador.....	5,920,365	7,070,090	6,262,085	3,220,600	12.3	11.1	13.3	9.7
Panama.....	1,426,085	1,116,253	618,416	276,782	3.0	1.8	1.3	.8
United Kingdom.....	10,225,205	13,124,077	6,058,672	1,903,144	21.2	20.7	12.9	5.7
Other countries.....	9,939,933	14,640,643	7,568,106	4,333,228	20.4	23.0	16.2	13.1
Total.....	48,274,929	63,460,713	46,992,721	33,221,502	100.0	100.0	100.0	100.0

¹ For "Lard, neutral, the average is for 4 years, 1911-1914.

TABLE 254.—Destination of principal farm products exported from the United States, 1910-1918—Continued.

Article, and country to which consigned.	Quantity.				Per cent of total.			
	Year ending June 30—							
	Average, 1910-1914.	1916	1917	1918 (prel.).	Average, 1910-1914.	1916	1917	1918 (prel.).
VEGETABLE MATTER.								
Cotton:	<i>Pounds.</i>	<i>Pounds.</i>	<i>Pounds.</i>	<i>Pounds.</i>				
Austria-Hungary.....	48,200,615				1.1			
Belgium.....	91,891,387				2.1			
Canada.....	76,708,788	98,829,599	93,600,456	124,986,426	1.7	3.2	3.0	5.4
France.....	543,310,082	445,187,759	527,874,622	329,276,533	12.3	14.4	17.1	14.2
Germany.....	1,257,474,563				28.5			
Italy.....	250,388,023	418,457,552	343,578,824	184,606,646	5.7	13.6	11.1	8.0
Japan.....	148,287,700	251,538,465	265,445,968	291,772,827	3.4	8.2	8.6	12.6
Mexico.....	10,601,091	11,847,741	2,648,957	5,353,162	.2	.4	.1	.2
Netherlands.....	12,177,934	51,043,560	31,080,490	5,049,224	.3	1.7	1.0	.2
Russia, European.....	43,788,355	86,724,722	24,594,286	7,972,533	1.0	2.8	.8	.3
Spain.....	134,932,086	170,122,980	197,046,594	129,596,749	3.1	5.5	6.4	5.6
Sweden.....	18,142,436	30,254,928	53,040,674	517,866	.4	1.0	1.7	
United Kingdom.....	1,754,711,933	1,380,444,961	1,447,711,674	1,193,550,402	39.7	44.8	46.9	51.4
Other countries.....	29,187,164	139,617,858	101,458,241	47,829,297	.5	4.4	3.3	2.1
Total.....	4,419,802,157	3,084,070,125	3,088,080,786	2,320,511,665	100.0	100.0	100.0	100.0
Fruits:								
Apples, dried—								
Germany.....	17,473,832				49.7			
Netherlands.....	9,612,942	1,878,251	187,286		27.4	11.6	1.8	
Other countries.....	8,050,439	14,340,923	10,170,505		22.9	88.4	98.2	
Total.....	35,137,213	16,219,174	10,357,791	2,602,590	100.0	100.0	100.0	
Apples, fresh—	<i>Barrels.</i>	<i>Barrels.</i>	<i>Barrels.</i>	<i>Barrels.</i>				
Canada.....	221,431	301,986	314,955	457,948	14.3	20.6	18.1	72.1
Germany.....	157,020				10.1			
United Kingdom.....	1,020,968	874,587	1,147,412	1,766	65.8	59.6	65.9	.3
Other countries.....	151,834	289,748	277,630	175,695	9.8	19.8	16.0	27.6
Total.....	1,551,253	1,466,321	1,739,997	635,409	100.0	100.0	100.0	100.0
Apricots, dried—	<i>Pounds.</i>	<i>Pounds.</i>	<i>Pounds.</i>	<i>Pounds.</i>				
Belgium.....	956,675				4.9			
Canada.....	1,117,625	1,558,407	751,012	1,334,275	5.7	6.5	7.6	25.8
France.....	2,558,956	2,570,491	5,754,643	465,525	13.2	10.7	58.5	9.0
Germany.....	5,208,071				26.8			
Netherlands.....	2,204,930	2,526,953	345,031		11.3	10.6	3.5	
United Kingdom.....	5,552,246	5,783,717	614,139	787,913	28.6	24.2	6.2	15.2
Other countries.....	1,839,506	11,500,222	2,376,294	2,587,905	9.5	48.0	24.2	50.0
Total.....	19,438,009	23,939,790	9,841,119	5,175,618	100.0	100.0	100.0	100.0
Oranges—	<i>Boxes.</i>	<i>Boxes.</i>	<i>Boxes.</i>	<i>Boxes.</i>				
Canada.....	1,135,194	1,489,746	1,726,394	1,190,629	95.7	94.6	93.3	96.0
Other countries.....	50,988	85,296	123,978	49,848	4.3	5.4	6.7	4.0
Total.....	1,186,182	1,575,042	1,850,372	1,240,477	100.0	100.0	100.0	100.0
Prunes—	<i>Pounds.</i>	<i>Pounds.</i>	<i>Pounds.</i>	<i>Pounds.</i>				
Belgium.....	5,005,565				6.2			
Canada.....	11,327,559	11,857,965	11,112,227	18,025,903	14.1	20.7	18.6	54.7
France.....	10,226,468	4,869,201	23,852,707	2,490,874	12.7	8.5	40.0	7.6
Germany.....	29,420,239				36.6			
Netherlands.....	7,238,048	2,467,052	330,580		9.0	4.3	.6	
United Kingdom.....	8,847,965	14,967,084	10,765,070	4,827,806	11.0	26.1	18.0	14.7
Other countries.....	8,361,806	23,261,525	13,584,557	7,581,963	10.4	40.4	22.8	23.0
Total.....	80,427,650	57,422,827	59,645,141	32,926,546	100.0	100.0	100.0	100.0
Fruits canned—	<i>Dollars.</i>	<i>Dollars.</i>	<i>Dollars.</i>	<i>Dollars.</i>				
United Kingdom.....	2,715,863	5,284,344	3,627,823	3,029,924	68.5	75.0	59.1	43.1
Other countries.....	1,247,786	1,765,717	2,510,869	3,994,542	31.5	25.0	40.9	56.9
Total.....	3,963,649	7,050,061	6,138,692	7,024,466	100.0	100.0	100.0	100.0

TABLE 254.—Destination of principal farm products exported from the United States, 1910-1918—Continued.

Article, and country to which consigned.	Quantity.				Per cent of total.			
	Year ending June 30—							
	Average, 1910-1914.	1916	1917	1918 (prel.).	Average, 1910-1914.	1916	1917	1918 (prel.).
VEGETABLE MATTER—continued.								
Glucose and grape sugar:	<i>Pounds.</i>	<i>Pounds.</i>	<i>Pounds.</i>	<i>Pounds.</i>				
Argentina.....	5,571,728	7,187,405	2,751,150	3.1	3.9	1.3
British Oceania.....	8,631,878	4,058,916	1,729,816	4.8	2.2	.8
United Kingdom.....	145,950,270	145,862,104	160,716,035	80.8	78.2	74.8
Other countries.....	20,370,027	29,297,757	49,776,314	11.3	15.7	23.1
Total.....	180,523,903	186,406,182	214,973,315	97,858,301	100.0	100.0	100.0
Grain and grain products:								
Corn—	<i>Bushels.</i>	<i>Bushels.</i>	<i>Bushels.</i>	<i>Bushels.</i>				
Belgium.....	1,387,953	4,550	581,371	3,714,233	3.59
Canada.....	8,379,334	6,568,407	15,724,838	7,895,892	21.0	17.2	24.3	19.3
Cuba.....	2,300,521	3,231,323	2,819,278	1,142,293	5.8	8.5	4.4	2.8
Denmark.....	2,493,820	9,527,032	7,075,254	6.3	24.9	10.9
Germany.....	5,231,554	13.1
Mexico.....	2,500,803	3,678,934	2,530,699	3,272,754	6.3	9.6	3.9	8.0
Netherlands.....	5,111,282	5,705,625	7,923,706	246,004	12.8	14.9	12.2	.6
United Kingdom.....	10,906,171	5,627,128	24,493,817	21,197,784	27.4	14.7	37.8	51.7
Other countries.....	1,498,252	3,874,013	3,571,879	3,528,867	3.8	10.2	5.6	8.5
Total.....	39,809,690	38,217,012	64,720,842	40,997,827	100.0	100.0	100.0	100.0
Wheat—								
Belgium.....	7,195,138	2,682,919	2,698,044	6,007,986	12.6	1.5	1.8	17.6
Canada.....	1,776,247	6,244,732	4,714,836	252,540	3.1	3.6	3.1	.7
France.....	3,001,698	21,802,818	16,253,262	3,837,927	5.3	12.6	10.8	11.2
Germany.....	6,154,503	10.8
Italy.....	2,367,307	31,441,667	13,746,512	6,756,191	4.2	18.1	9.2	19.8
Japan.....	2,338,152	14,828	4.1
Mexico.....	1,178,864	17,624	54,597	2.1
Netherlands.....	8,350,709	21,070,335	19,127,675	155,550	14.7	12.2	12.8	.5
United Kingdom.....	21,806,112	53,550,376	67,976,120	15,129,803	38.3	30.9	45.4	44.3
Other countries.....	2,744,498	36,448,716	25,260,381	1,978,856	4.8	21.1	16.9	5.9
Total.....	56,913,228	173,274,015	149,831,427	34,118,853	100.0	100.0	100.0	100.0
Wheat flour—	<i>Barrels.</i>	<i>Barrels.</i>	<i>Barrels.</i>	<i>Barrels.</i>				
Brazil.....	567,444	734,726	301,614	101,927	5.3	4.7	2.5	.5
British West Indies.....	472,953	372,159	372,242	4.4	2.4	3.1
Canada.....	82,821	50,424	77,115	83,534	.8	.3	.6	.4
China.....	263,882	10,762	9,806	2.5	.1	.1
Cuba.....	856,239	1,124,562	1,016,675	679,689	8.0	7.2	8.5	3.1
Finland.....	243,856	2.3
Germany.....	187,457	1.8
Haiti.....	233,932	221,455	127,458	10,924	2.2	1.4	1.1
Hongkong.....	1,121,139	356,263	61,800	1,250	10.5	2.3	.5
Japan.....	612,879	54,475	4,083	5.7	.4
Netherlands.....	818,637	219,644	591,182	69,253	7.7	1.4	5.0	.3
Norway.....	212,713	912,743	715,077	214,810	2.0	5.9	6.0	1.0
Philippine Islands.....	278,717	385,371	76,089	549	2.6	2.5	.6
United Kingdom.....	2,712,639	3,145,030	3,015,525	10,055,827	25.4	20.3	25.2	46.0
Other countries.....	2,013,327	7,933,055	5,574,112	10,662,388	18.8	51.1	46.8	48.7
Total.....	10,678,635	15,520,669	11,942,778	21,880,151	100.0	100.0	100.0	100.0
Hops:	<i>Pounds.</i>	<i>Pounds.</i>	<i>Pounds.</i>	<i>Pounds.</i>				
British Oceania.....	516,882	621,094	451,189	3.3	2.8	9.4
Canada.....	968,630	626,126	801,162	6.2	2.8	16.6
United Kingdom.....	13,880,669	19,703,283	823,654	89.3	87.9	17.1
Other countries.....	181,525	1,459,315	2,748,871	1.2	6.5	56.9
Total.....	15,547,756	22,409,818	4,824,876	3,494,579	100.0	100.0	100.0

TABLE 254.—*Destination of principal farm products exported from the United States, 1910-1918—Continued.*

Article, and country to which consigned.	Quantity.				Per cent of total.			
	Year ending June 30—							
	Average, 1910-1914.	1916	1917	1918 (prel.).	Average, 1910-1914.	1916	1917	1918 (prel.).
VEGETABLE MATTER—continued.								
Oil cake and oil-cake meal:								
Cottonseed—	<i>Pounds.</i>	<i>Pounds.</i>	<i>Pounds.</i>	<i>Pounds.</i>				
Belgium.....	30,009,935				3.2			
Denmark.....	335,176,189	812,720,685	673,151,482	4,704,000	35.9	76.9	58.5	10.5
Germany.....	316,183,442				33.9			
Netherlands.....	55,879,799	4,818,400	23,231,880		6.0	.5	2.0	
Norway.....	28,019,121	3,024,095	71,814,963		3.0	.3	6.2	
United Kingdom.....	146,111,558	105,360,887	219,530,899	19,751,335	15.7	10.0	19.1	44.2
Other countries.....	21,908,452	131,297,502	162,430,467	20,225,458	2.3	12.3	14.2	45.3
Total.....	933,288,496	1,057,221,569	1,150,159,691	44,680,793	100.0	100.0	100.0	100.0
Linseed or flaxseed—								
Belgium.....	238,955,020				43.7			
France.....	34,587,191	13,100	4,408,251		5.2		.8	
Netherlands.....	230,782,728	445,707,867	292,984,477	448,656	42.4	69.5	54.6	.3
United Kingdom.....	42,781,016	25,532,292	86,400,787	98,785,060	6.5	4.0	16.1	65.2
Other countries.....	14,712,925	169,662,937	153,190,879	52,166,261	2.2	26.5	28.5	34.5
Total.....	661,818,880	640,916,196	536,984,394	151,399,977	100.0	100.0	100.0	100.0
Oils, vegetable:								
Cottonseed—								
Argentina.....	9,300,144	9,275,577	2,863,997	1,971,552	3.4	3.5	1.8	2.0
Austria-Hungary.....	4,951,218				1.8			
Belgium.....	4,053,300				1.5			
Canada.....	20,345,315	35,420,571	40,902,325	40,689,087	7.5	13.3	25.7	40.7
Chile.....	4,320,237	4,575,977	1,787,089	1,912,903	1.6	1.7	1.1	1.9
Cuba.....	3,522,682	6,754,878	8,710,957	11,070,037	1.3	2.5	5.5	11.1
France.....	14,510,409	33,500,328	3,187,870	6,221,545	5.3	12.6	2.0	6.2
Germany.....	13,184,524				4.9			
Italy.....	27,558,963	9,424,790	363,127		10.2	3.5	.2	
Mexico.....	21,994,280	2,674,740	918,959	229,847	8.1	1.0	.6	.2
Netherlands.....	58,258,887	56,981,676	28,034,879		21.5	21.4	17.6	
Norway.....	7,512,688	31,055,628	33,591,436	572,765	2.8	11.7	21.1	.6
Roumania.....	3,010,554				1.1			
Turkey, European.....	9,129,051				3.4			
United Kingdom.....	39,832,247	32,112,143	14,172,497	28,091,481	14.7	12.0	8.9	28.1
Uruguay.....	3,666,681	3,152,222	1,066,275	755,270	1.4	1.2	.7	.8
Other countries.....	26,277,418	41,583,527	23,312,356	8,490,587	9.5	15.6	14.8	8.4
Total.....	271,428,578	266,512,057	158,914,767	100,005,074	100.0	100.0	100.0	100.0
Tobacco, leaf, stems, and trimmings:¹								
Belgium.....	11,722,421			75,523	3.0			
British Africa.....	6,233,693	7,820,355	10,410,254	8,352,952	1.6	1.8	2.5	2.9
British Oceania.....	13,984,064	9,797,284	15,927,720	9,353,648	3.6	2.2	3.9	3.2
Canada.....	15,149,901	18,621,186	15,275,422	17,577,987	3.9	4.2	3.7	6.1
China.....	7,061,404	8,908,844	9,887,842	7,959,312	1.8	2.0	2.4	2.8
France.....	42,503,455	32,977,894	70,514,607	73,372,601	10.8	18.7	17.1	25.4
French Africa.....	4,167,210	4,196,016	3,742,479	2,511,968	1.1	.9	.9	.9
Germany.....	37,803,645				9.6			
Italy.....	41,706,176	41,000,738	45,587,226	38,540,529	10.6	9.2	11.1	13.3
Japan.....	2,997,113	1,158,083	3,449,974	2,346,479	.8	.3	.8	.8
Netherlands.....	26,971,456	56,928,906	55,123,517	1,359,367	6.9	12.8	13.4	.5
Spain.....	20,111,895	9,779,100	10,692,009	17,536,192	5.1	2.2	2.6	6.1
United Kingdom.....	139,862,251	150,639,054	122,725,357	89,433,995	35.7	34.0	29.8	31.0
Other countries.....	21,908,357	51,466,296	48,262,453	20,360,958	5.5	11.7	11.8	7.0
Total.....	392,183,071	443,293,156	411,598,860	288,781,511	100.0	100.0	100.0	100.0

¹ Leaf only for 1918.

TABLE 254.—Destination of principal farm products exported from the United States, 1910-1918—Continued.

Article, and country to which consigned.	Quantity.				Per cent of total.			
	Year ending June 30—							
	Average, 1910-1914.	1916	1917	1918 (prel.).	Average, 1910-1914.	1916	1917	1918 (prel.).
FOREST PRODUCTS.								
Naval stores:								
Rosin—	<i>Barrels.</i>	<i>Barrels.</i>	<i>Barrels.</i>	<i>Barrels.</i>				
Argentina.....	110,085	97,306	120,287	149,536	4.6	6.2	7.3	13.9
Austria-Hungary.....	76,883	3.2
Belgium.....	140,413	5.8
Brazil.....	155,226	132,545	147,462	158,824	6.5	8.4	9.0	14.8
Canada.....	80,882	120,146	172,578	132,070	3.4	7.6	10.5	12.3
Germany.....	727,521	30.2
Italy.....	98,964	117,740	54,927	10,056	4.1	7.5	3.4	9
Netherlands.....	208,598	18,175	720	8.7	1.2
Russia, European.....	104,657	70,537	74,080	4.3	4.5	4.5
United Kingdom.....	501,572	557,611	673,268	274,976	20.8	35.5	41.1	25.6
Other countries.....	201,675	457,219	395,268	348,427	8.4	29.1	24.2	32.5
Total.....	2,406,476	1,571,279	1,638,590	1,073,889	100.0	100.0	100.0	100.0
Turpentine, spirits of—								
Argentina.....	<i>Gallons.</i>	<i>Gallons.</i>	<i>Gallons.</i>	<i>Gallons.</i>				
Argentina.....	524,265	459,460	356,953	321,797	2.9	4.9	4.0	6.3
Belgium.....	1,748,419	9.7
British Oceania.....	639,300	590,760	838,631	851,328	3.6	6.3	9.5	16.7
Canada.....	1,027,501	1,026,768	1,109,029	978,125	5.7	11.0	12.5	19.2
Germany.....	2,868,253	15.9
Netherlands.....	3,160,749	442,682	60,892	17.6	4.8	8
United Kingdom.....	6,774,171	5,561,957	5,327,100	1,413,732	37.7	59.7	60.2	27.7
Other countries.....	1,240,348	1,228,641	1,143,270	1,535,142	6.9	13.3	13.0	30.1
Total.....	17,989,006	9,310,268	8,841,875	5,100,124	100.0	100.0	100.0	100.0
Lumber—								
Fir—								
Argentina.....	<i>M feet.</i>	<i>M feet.</i>	<i>M feet.</i>	<i>M feet.</i>				
Australia.....	101,546	79,785	63,865	(1)	37.8	27.5	23.3
Canada.....	11,031	27,463	20,562		4.1	9.5	7.5
Chile.....	14,200	34,561	45,416		5.3	11.9	16.6
China.....	30,745	21,348	8,121		11.5	7.4	3.0
Japan.....	5,810	20,002	29,044		2.2	6.9	10.6
Mexico.....	(1) 7,619	6,033	7,421		2.8	2.1	2.7
New Zealand.....	6,862	4,017	3,283		2.6	1.4	1.2
Panama.....	16,783	17,919	4,769		6.3	6.2	1.7
Peru.....	28,172	38,539	51,053		10.5	13.3	18.6
United Kingdom.....	30,118	10,372	13,646		11.2	3.6	5.0
Other countries.....	15,569	29,941	27,159		5.7	10.2	9.8
Total.....	(1) 268,455	289,980	274,339	(1) 274,339		(1) 100.0	100.0	100.0
Oak—								
Argentina.....	3,547	4,535	3,444	(1)	3.6	8.4	5.1
Canada.....	(1) 29,284	36,908	47,183		29.6	68.3	70.2
France.....	455	474	7
United Kingdom.....	56,157	2,648	9,753		56.7	4.9	14.5
Other countries.....	10,002	9,484	6,362		10.1	17.6	9.5
Total.....	(1) 98,990	54,030	67,216	(1) 67,216	(1) 100.0	100.0	100.0	
Pine, yellow, long leaf—								
Argentina.....	74,975	37,329	33,317	(1)	14.8	9.3	9.6
Brazil.....	7,457	3,266	2,050		1.5	8	6
Canada.....	16,790	804	2,270		3.3	2	7
Cuba.....	167,163	158,106	192,590		33.1	39.3	55.0
France.....	6,438	9,430	8,635		1.3	2.3	2.5
Italy.....	40,148	9,030	1,293		8.0	2.2	4
Mexico.....	15,090	14,954	35,346		3.0	3.7	10.2
Panama.....	19,658	28,771	11,884		3.9	7.1	3.4
Spain.....	16,508	10,074	2,792		3.3	2.5	8
United Kingdom.....	77,495	59,011	10,220		15.3	14.7	3.0
Uruguay.....	9,517	4,841	3,961		1.9	1.2	1.1
Other countries.....	53,687	67,088	41,759		10.6	16.7	12.1
Total.....	(1) 504,926	402,704	346,117	(1) 346,117		(1) 100.0	100.0	100.0

1 Not separately stated.

TABLE 254.—Destination of principal farm products exported from the United States, 1910-1918—Continued.

Article, and country to which consigned.	Quantity.				Per cent of total.			
	Year ending June 30—							
	Average, 1910-1914.	1916	1917	1918 (prel.).	Average, 1910-1914.	1916	1917	1918 (prel.).
FOREST PRODUCTS—con.								
Naval stores—Contd.								
Lumber—Continued.								
Railroad ties—								
Canada.....	(1)	<i>M feet.</i> 1,017,724	<i>M feet.</i> 1,152,707	<i>M feet.</i> 1,487,101	(1)	24.9	29.3	43.3
Cuba.....		286,271	502,059	804,718		7.0	12.8	23.4
France.....		223,426	281,612	97,187		5.5	7.2	2.8
Honduras.....		175,217	79,906	70,379		4.3	2.0	2.0
Mexico.....		353,174	692,923	611,698		8.6	17.6	17.8
United Kingdom.....		1,822,649	685,718	18,069		44.5	17.4	.5
Other countries.....	215,804	539,182	346,145	5.2	13.7	10.2		
Total.....	(1)	4,094,265	3,934,107	3,435,297	(1)	100.0	100.0	100.0
Timber, sawed—								
Pitch pine, long leaf—								
Canada.....	(1)	5,851	1,584	1,830	(1)	3.3	1.1	2.8
France.....		2,859	12,477	2,020		1.6	8.3	3.1
Italy.....		29,946	17,684	983		17.0	11.8	1.5
United Kingdom.....		110,586	88,465	31,949		63.0	59.2	49.0
Other countries.....		26,521	29,317	28,451		15.1	19.6	43.6
Total.....	(1)	175,763	149,527	65,233	(1)	100.0	100.0	100.0

TABLE 255.—Origin of principal farm products imported into the United States, 1910-1918.

Article and country of origin.	Quantity.				Per cent of total.			
	Year ending June 30—							
	Average 1910-1914.	1916	1917	1918 (prel.).	Average 1910-1914.	1916	1917	1918 (prel.).
ANIMAL MATTER.								
Cattle:								
Canada.....	<i>Number.</i> 56,097	<i>Number.</i> 238,025	<i>Number.</i> 189,285	<i>Number.</i> 185,089	14.1	54.2	50.5	63.0
Mexico.....	339,616	197,788	183,827	105,470	85.4	45.0	49.0	35.9
Other countries.....	1,737	3,372	1,714	3,160	.5	0.8	.5	1.1
Total.....	397,450	439,185	374,826	293,719	100.0	100.0	100.0	100.0
Horses:								
Canada.....	3,199	6,250	6,348	22.6	40.1	50.4
France.....	1,933	110	170	13.6	0.7	1.4
Mexico.....	6,846	8,341	5,331	48.3	53.6	42.4
Other countries.....	2,191	855	735	15.5	5.6	5.8
Total.....	14,169	15,556	12,584	5,099	100.0	100.0	100.0
Dairy products:								
Cheese, including sub-								
stitutes—								
France.....	<i>Pounds.</i> 4,142,716	<i>Pounds.</i> 2,321,543	<i>Pounds.</i> 1,937,341	<i>Pounds.</i> 1,026,117	8.4	7.7	13.4	10.4
Netherlands.....	3,365,038	578,201	249,371	6.8	1.9	1.7
Italy.....	20,834,962	16,084,058	8,482,280	16,044	42.3	53.4	58.6	0.2
Switzerland.....	16,924,388	9,514,008	1,640,656	34.4	31.6	11.3
Other countries.....	3,953,013	1,590,189	2,171,866	8,797,144	8.1	5.4	15.0	89.4
Total.....	49,220,117	30,087,999	14,481,514	9,839,305	100.0	100.0	100.0	100.0

1 Not separately stated.

TABLE 255.—Origin of principal farm products imported into the United States, 1910-1918—Continued.

Article and country of origin.	Quantity.				Per cent of total.			
	Year ending June 30—							
	Average 1910-1914.	1916	1917	1918 (prel.).	Average 1910-1914.	1916	1917	1918 (prel.).
ANIMAL MATTER—contd.								
Fibers, animal:								
Silk, raw—								
China.....	<i>Pounds.</i> 5,133,658	7,419,616	7,006,700	6,059,089	21.6	22.4	20.7	17.0
Italy.....	2,605,466	2,545,845	467,405	7,309	10.9	7.7	1.4	0.6
Japan.....	15,591,700	22,914,898	26,341,833	28,371,063	65.5	69.3	77.8	82.4
Other countries.....	468,574	190,543	52,947	10,114	2.0	0.6	0.1
Total.....	23,799,398	33,070,902	33,868,885	34,447,575	100.0	100.0	100.0	100.0
Wool, class 1:								
Argentina.....	112,032,886	110,085,992	187,078,443	161,981,865	27.0	27.3	66.9	53.3
Australia, Commonwealth of.....	86,105,371	157,433,859	802,618	29,956,449	20.7	39.1	0.3	9.9
Belgium.....	7,212,328	1.7
New Zealand.....	22,264,826	16,697,578	262,312	4,117,146	5.4	4.1	0.0	1.4
United Kingdom.....	155,795,851	30,188,711	1,555,182	161,498	37.5	7.5	.6	0.0
Uruguay.....	21,022,160	8,941,506	33,304,462	17,785,170	5.1	2.2	11.9	5.9
Other countries.....	10,795,206	79,773,939	56,478,484	89,866,812	2.6	19.8	20.3	29.5
Total.....	415,228,628	403,121,585	279,481,501	303,868,940	100.0	100.0	100.0	100.0
Wool, class 2:								
Canada.....	8,096,949	4,930,170	7,883,007	8,419,647	8.5	37.1	46.2	60.3
United Kingdom.....	71,640,116	4,135,963	56,400	75.1	31.1	.3
Other countries.....	15,617,446	4,226,027	9,116,546	5,534,310	16.4	31.8	53.5	39.7
Total.....	95,354,511	13,292,160	17,055,953	13,953,957	100.0	100.0	100.0	100.0
Wool, class 3:								
Argentina.....	19,674,244	14,670,272	15,075,173	15,258,176	3.7	13.4	22.3	25.9
British East Indies.....	19,620,964	3,025,191	428,661	41,309	3.7	2.8	.6	.1
China.....	164,032,370	44,192,310	25,448,769	24,432,434	31.2	40.4	37.6	41.4
Russia (Asiatic and European).....	105,077,111	3,269,328	2,699,379	20.0	3.0	4.6
Turkey (Asiatic).....	34,698,915	42,560	9,889	6.6
United Kingdom.....	115,574,754	25,969,190	2,795,512	138,367	22.0	23.8	4.1	.2
Other countries.....	66,940,116	18,100,148	23,914,667	16,424,997	12.8	16.6	35.4	27.8
Total.....	525,618,474	109,268,999	67,672,671	58,994,662	100.0	100.0	100.0	100.0
Packing-house products:								
Hides and skins, other than furs—								
Calf skins—								
Belgium.....	4,238,167	5.1
Canada.....	6,267,359	4,612,406	2,752,316	2,382,544	7.5	7.2	5.9	18.1
France.....	4,874,163	7,994,908	2,437,902	70,236	5.8	12.5	5.3	.5
Germany.....	16,567,590	19.8
Netherlands.....	7,839,510	8,750,387	1,995,942	492,427	9.4	13.6	4.3	3.7
Russia (European).....	22,419,150	1,515,426	663,341	26.8	3.3	5.0
United Kingdom.....	4,501,812	4,542,178	5,259,334	234,854	5.4	7.1	11.4	1.8
Other countries.....	16,810,652	38,235,614	32,375,275	9,317,913	20.2	59.6	69.8	70.9
Total.....	83,518,403	64,135,493	46,336,195	13,161,315	100.0	100.0	100.0	100.0
Cattle hides—								
Argentina.....	71,324,202	149,537,519	118,987,435	103,468,863	28.1	34.4	30.8	38.7
Belgium.....	9,238,890	3.6
Brazil.....	1,745,003	59,362,639	49,918,402	19,213,317	.7	13.7	12.9	7.2
Canada.....	35,445,887	27,217,476	23,240,504	29,353,473	14.0	6.3	6.0	11.0
Colombia.....	5,634,740	10,736,678	15,340,041	13,837,088	2.2	2.5	4.0	5.2
Cuba.....	4,516,358	16,068,265	13,487,275	12,065,247	1.8	3.7	3.5	4.5
East Indies.....	4,965,027	19,388,264	17,175,504	2.0	4.5	4.4
France.....	17,583,731	2,885,199	520,894	54,379	6.9	0.7	0.1
Germany.....	8,288,419	3.3
Italy.....	3,452,654	219,402	1.4	0.1
Mexico.....	29,277,132	42,895,513	36,137,722	23,851,700	11.6	9.9	9.3	8.9
Netherlands.....	6,142,184	4,214,621	5,029,905	623,220	2.4	1.0	1.3	0.2
Russia (European).....	9,492,894	3.7
United Kingdom.....	9,167,276	6,578,567	3,528,480	205,830	3.6	1.5	0.9	0.1
Uruguay.....	12,911,444	43,497,431	38,138,800	25,693,227	5.1	10.0	9.9	9.6
Venezuela.....	5,065,636	7,530,524	8,053,116	4,772,413	2.0	1.7	2.1	1.8
Other countries.....	19,178,468	44,265,075	56,822,548	34,361,003	7.6	10.1	14.7	12.8
Total.....	253,429,945	434,177,771	386,600,528	267,499,770	100.0	100.0	100.0	100.0

TABLE 255.—Origin of principal farm products imported into the United States, 1910-1918—Continued.

Article and country of origin.	Quantity.				Per cent of total.			
	Year ending June 30—							
	Average 1910-1914.	1916	1917	1918 (prel.).	Average 1910-1914.	1916	1917	1918 (prel.).
ANIMAL MATTER—contd.								
Packing - house products—Continued.								
Hides and skins, other than furs—Con.								
Goatskins—								
Aden.....	<i>Pounds.</i> 3,656,513	4,151,509	3,499,925	2,031,272	3.8	4.1	3.3	3.0
Africa.....	3,772,149	6,913,422	7,001,127	3.9	6.9	6.6
Argentina.....	3,944,343	6,337,138	5,566,223	2,739,243	4.1	6.3	5.3	4.1
Brazil.....	3,621,530	6,919,497	4,601,848	3,324,871	3.8	6.9	4.4	5.0
China.....	9,394,904	15,084,600	21,340,353	12,105,273	9.8	15.0	20.2	18.1
East Indies.....	41,905,364	40,877,117	46,196,646	33,208,580	43.7	40.6	43.7	49.6
France.....	2,543,276	971,848	1,046,413	190,967	2.7	1.0	1.0	0.3
Mexico.....	5,534,421	3,833,616	4,642,396	2,629,706	5.8	3.8	4.4	3.9
Russia (European).....	5,425,651	5.7
United Kingdom.....	5,180,243	5,936,113	2,181,600	352,567	5.4	5.9	2.1	0.5
Other countries.....	10,843,413	9,632,161	9,563,776	10,350,458	11.3	9.5	9.0	15.5
Total.....	95,821,807	100,657,021	105,640,307	66,932,937	100.0	100.0	100.0	100.0
Sheepskins—								
Argentina.....	5,270,655	13,308,025	22,698,632	14,644,079	8.1	13.1	23.7	26.4
Brazil.....	1,244,866	3,257,445	2,326,475	1,346,169	1.9	3.2	2.4	2.4
British Oceania.....	7,716,554	14,653,153	10,879,286	10,364,512	11.9	14.4	11.4	18.7
Canada.....	2,109,858	3,105,951	2,699,873	1,819,375	3.2	3.1	2.8	3.3
France.....	2,637,365	2,089,161	1,362,709	413,334	4.1	2.1	1.4	0.7
Russia (European).....	6,334,259	22,840	9.7	0.0
United Kingdom.....	28,494,981	33,287,127	17,622,773	3,843,102	43.7	32.8	18.4	6.4
Other countries.....	11,328,467	31,735,579	38,140,850	23,338,344	17.4	31.3	39.9	42.1
Total.....	65,077,005	101,459,281	95,730,598	55,468,915	100.0	100.0	100.0	100.0
VEGETABLE MATTER.								
Cocoa, crude:								
Brazil.....	17,128,176	45,657,401	51,461,624	91,351,529	12.1	18.8	15.2	22.9
British West Indies.....	36,119,338	39,933,405	60,139,918	51,438,970	25.5	16.4	17.7	12.9
Dominican Republic.....	24,818,840	48,990,707	61,443,869	39,851,184	17.5	20.1	18.1	10.0
Ecuador.....	19,120,725	31,913,350	67,227,698	76,786,657	13.5	13.1	19.9	19.2
Portugal.....	18,751,436	7,531,924	16,551,624	134,904	13.2	3.1	4.9	0.0
United Kingdom.....	8,534,723	13,408,058	11,650,811	1,038,142	6.0	5.5	3.4	0.3
Other countries.....	17,327,197	55,797,094	70,178,332	138,439,015	23.0	13.0	20.8	34.7
Total.....	141,800,435	243,231,939	338,653,876	399,040,401	100.0	100.0	100.0	100.0
Coffee:								
Brazil.....	673,058,602	849,405,925	907,197,562	743,958,456	74.8	70.7	68.7	65.0
Central American States and British Honduras.....								
Honduras.....	38,789,033	95,573,010	133,289,460	166,292,751	4.3	8.0	10.1	14.5
Colombia.....	70,516,164	109,363,456	150,591,659	112,159,390	7.8	9.1	11.4	9.8
East Indies.....	9,893,785	6,258,733	4,024,243	4,687,538	1.1	0.5	0.3	0.4
Mexico.....	31,220,334	49,832,801	54,908,223	31,118,513	3.5	4.1	4.2	2.7
Netherlands.....	2,565,776	50,896	150,000	0.3
Venezuela.....	45,806,538	73,405,301	58,050,584	50,122,484	5.1	6.1	4.4	4.4
West Indies and Bermuda.....	5,614,876	10,832,182	9,661,212	30,240,917	0.6	0.9	0.7	2.6
Other countries.....	21,874,219	6,382,181	1,997,859	5,310,840	2.5	0.6	0.2	0.6
Total.....	899,339,327	1,201,104,485	1,319,870,802	1,143,890,889	100.0	100.0	100.0	100.0
Fibers, vegetable:								
Cotton—								
Egypt.....	77,876,828	171,528,669	88,772,585	47,532,526	70.2	73.7	60.4	46.0
Peru.....	5,544,333	4,934,448	5,885,836	9,417,672	5.0	2.1	4.0	9.1
United Kingdom.....	7,687,013	14,227,785	13,817,744	14	6.9	6.1	9.4
British India.....	2,533,063	2,624,581	1,957,332	3,147,235	2.3	1.1	1.3	3.0
Mexico.....	7,761,757	18,440,969	16,428,482	17,862,209	7.0	7.9	11.2	17.3
Other countries.....	9,554,004	21,044,610	20,190,656	25,365,991	8.6	9.1	13.7	24.6
Total.....	110,956,998	232,801,062	147,061,635	103,325,647	100.0	100.0	100.0	100.0

TABLE 255.—Origin of principal farm products imported into the United States, 1910-1918—Continued.

Article and country of origin.	Quantity.				Per cent of total.			
	Year ending June 30—							
	Average 1910-1914.	1916	1917	1918 (prel.).	Average 1910-1914.	1916	1917	1918 (prel.).
VEGETABLE MATTER—continued.								
Fibers, vegetable—Con.								
Flax—	<i>Long tons.</i>	<i>Long tons.</i>	<i>Long tons.</i>	<i>Long tons.</i>				
Belgium.....	2,100	20	19.5	0.3
Russia (European)...	2,862	2,521	2,872	2,955	26.6	36.3	36.3	52.7
United Kingdom.....	4,308	3,230	3,814	1,129	40.1	46.5	48.2	20.1
Other countries.....	1,482	1,168	1,232	1,523	13.8	16.9	15.5	27.2
Total.....	10,752	6,939	7,918	5,607	100.0	100.0	100.0
Jute and jute butts—								
British East Indies..	89,320	99,780	109,685	95.9	92.1	97.3
Other countries.....	3,843	8,542	3,010	4.1	7.9	2.7
Total.....	93,163	108,322	112,695	78,312	100.0	100.0	100.0
Manila fiber—								
Philippine Islands..	70,513	78,809	76,300	98.0	99.9	99.4
Other countries.....	1,409	83	465	2.0	0.1	0.6
Total.....	71,922	78,892	76,765	86,220	100.0	100.0	100.0
Sisal grass—								
Mexico.....	128,314	220,994	130,861	91.4	96.7	91.3
Other countries.....	12,001	7,616	12,546	8.6	3.3	8.7
Total.....	140,315	228,610	143,407	150,164	100.0	100.0	100.0	100.0
Fruit:								
Bananas—	<i>Bunches.</i>	<i>Bunches.</i>	<i>Bunches.</i>	<i>Bunches.</i>				
British West Indies	14,404,120	4,927,435	2,191,516	33.0	13.4	6.3
Central American States and British Honduras.....	23,010,323	24,440,649	26,323,639	25,895,734	52.7	66.5	76.0	75.0
Cuba.....	2,388,024	2,859,021	2,184,110	1,151,165	5.5	7.8	6.3	3.3
South America.....	2,344,511	2,710,047	3,578,500	5.4	7.4	10.3
Other countries.....	1,536,446	1,817,552	383,414	7,502,484	3.4	4.9	1.1	21.7
Total.....	43,683,424	36,754,704	34,661,179	34,549,383	100.0	100.0	100.0	100.0
Nuts:								
Walnuts—	<i>Pounds.</i>	<i>Pounds.</i>	<i>Pounds.</i>	<i>Pounds.</i>				
Austria-Hungary....	842,698	2.5
France.....	21,026,019	22,443,477	18,302,907	9,099,952	62.5	60.9	47.3	39.1
Italy.....	5,754,825	8,489,385	7,822,612	6,260,317	17.1	23.0	20.2	26.9
Turkey (Asiatic)....	1,249,497	3.7
Other countries.....	4,793,510	5,926,072	12,599,843	7,928,901	14.2	16.1	32.5	34.0
Total.....	33,666,549	36,858,934	38,725,362	23,289,170	100.0	100.0	100.0	100.0
Oils, vegetable:								
Olive, salad—	<i>Gallons.</i>	<i>Gallons.</i>	<i>Gallons.</i>	<i>Gallons.</i>				
France.....	864,796	891,769	726,771	227,617	17.7	12.3	9.6	9.0
Italy.....	3,293,220	4,700,412	2,882,535	200,403	67.5	65.1	38.3	7.9
Other countries.....	718,607	1,632,250	3,923,843	2,109,492	14.8	22.6	52.1	83.1
Total.....	4,876,623	7,224,431	7,533,149	2,537,512	100.0	100.0	100.0	100.0
Soya-bean oil—	<i>Pounds.</i>	<i>Pounds.</i>	<i>Pounds.</i>	<i>Pounds.</i>				
Japan.....	9,253,941	70,384,049	67,169,454	86,830,583	48.9	71.7	41.3	25.8
United Kingdom....	4,617,154	187,722	10,130	24.4	0.2
Other countries.....	5,036,211	27,547,924	95,510,651	249,994,063	26.7	28.1	58.7	74.2
Total.....	18,907,306	98,119,695	162,690,235	336,824,646	100.0	100.0	100.0	100.0
Opium:								
Turkey (Asiatic and European).....	380,536	27,883	599	77.9	19.0	0.7
United Kingdom....	68,587	62,665	65,356	14.0	42.7	75.3
Other countries.....	39,387	56,110	20,857	8.1	38.3	24.0
Total.....	488,510	146,658	86,812	157,834	100.0	100.0	100.0

TABLE 255.—Origin of principal farm products imported into the United States, 1910-1918—Continued.

Article and country of origin.	Quantity.				Per cent of total.			
	Year ending June 30—							
	Average 1910-1914.	1916	1917	1918 (prel.).	Average 1910-1914.	1916	1917	1918 (prel.).
VEGETABLE MATTER—continued.								
Seeds:								
Flaxseed or linseed—	<i>Bushels.</i>	<i>Bushels.</i>	<i>Bushels.</i>	<i>Bushels.</i>				
Argentina.....	1,974,021	11,468,039	5,009,441	7,253,501	27.2	78.1	40.4	55.0
Belgium.....	147,273				2.0			
British India.....	836,366		122,596		11.5		1.0	
Canada.....	4,110,370	3,094,735	7,014,573	5,501,391	56.6	21.2	56.6	41.7
United Kingdom.....	178,859	3			2.5			
Other countries.....	11,323	116,456	247,378	432,717	.2	.7	2.0	3.3
Total.....	7,258,212	14,679,233	12,393,988	13,187,609	100.0	100.0	100.0	100.0
Grass seed—								
Clover:	<i>Pounds.</i>	<i>Pounds.</i>	<i>Pounds.</i>	<i>Pounds.</i>				
Canada.....	5,128,518	1,620,609	5,654,366	4,697,881	20.0	3.9	31.1	58.9
France.....	7,979,405	26,964,867	10,047,945	1,317,004	31.1	64.4	55.3	16.5
Germany.....	6,556,388	44,000			25.5	.1		
Italy.....	2,297,896	10,300,153	660	1,285,064	9.0	24.6		16.1
Other countries.....	3,699,993	2,910,132	2,469,188	678,146	14.4	7.0	13.6	8.5
Total.....	25,662,200	41,839,761	18,172,159	7,978,095	100.0	100.0	100.0	100.0
Sugar, raw cane:								
Cuba.....	3,856,447,356	5,150,851,544	4,669,097,398	4,560,749,643	88.8	91.5	87.6	93.1
Dominican Republic.....	10,302,955	107,503,110	114,367,301	14,395,335	.2	1.9	2.1	.3
Dutch East Indies.....	179,217,222	32,941	21,813		4.1			
Philippine Islands.....	232,340,306	217,190,825	267,891,954	173,600,941	5.4	3.9	5.0	3.5
South America.....	39,783,149	118,659,613	158,107,460	75,980,455	.9	2.1	3.1	1.6
Other countries.....	23,016,602	37,034,733	120,101,434	73,550,651	.6	.6	2.2	1.5
Total.....	4,341,057,590	5,631,272,766	5,329,587,360	4,898,277,025	100.0	100.0	100.0	100.0
Tea:								
Canada.....	2,787,373	2,600,705	3,160,459	1,914,169	2.9	2.4	3.1	1.3
China.....	22,932,930	20,422,700	19,810,428	21,082,866	24.1	18.6	19.2	13.9
East Indies.....	10,500,188	14,855,825	13,139,514		11.0	13.5	12.7	
Japan.....	46,245,473	52,359,526	52,418,963	52,996,471	48.6	47.7	50.7	35.0
United Kingdom.....	11,620,183	19,066,241	13,857,721	487,063	12.2	17.4	13.4	.3
Other countries.....	1,040,002	560,938	977,325	74,834,363	1.2	.4	.9	49.5
Total.....	95,126,149	109,865,935	103,364,410	151,314,932	100.0	100.0	100.0	100.0
Tobacco leaf:								
Wrapper—								
Netherlands.....	6,087,084	4,963,761	2,426,322	353,172	96.4	97.9	61.3	7.8
Other countries.....	227,151	106,547	1,515,614	4,162,172	3.6	2.1	38.7	92.2
Total.....	6,314,235	5,070,308	3,941,936	4,515,344	100.0	100.0	100.0	100.0
Other leaf—								
Cuba.....	25,147,491	23,946,363	23,417,539	20,366,787	52.0	55.7	51.9	27.2
Germany.....	1,410,469				2.9			
Turkey (Asiatic).....	11,564,036		18,450		23.9			
Turkey (European).....	8,110,601	19,890	10,051		16.8			
Other countries.....	2,147,388	18,976,774	18,748,371	54,485,432	4.4	44.3	48.1	72.8
Total.....	48,379,985	42,943,027	42,194,411	74,852,219	100.0	100.0	100.0	100.0

TABLE 255.—Origin of principal farm products imported into the United States, 1910-1918—Continued.

Article and country of origin.	Quantity.				Per cent of total.			
	Year ending June 30—							
	Average, 1910-1914.	1916	1917	1918 (prel.).	Average 1910-1914.	1916	1917	1918 (prel.).
FOREST PRODUCTS.								
India rubber, crude:	<i>Pounds.</i>	<i>Pounds.</i>	<i>Pounds.</i>	<i>Pounds.</i>				
Belgium.....	6,262,187				5.9			
Brazil.....	40,290,919	54,968,227	56,818,966	41,277,914	38.1	20.5	17.0	10.6
Central American States and British Honduras.....	1,142,524	1,313,454	1,347,931	736,014	1.1	.5	.4	.2
East Indies.....	8,447,379	125,532,067	181,431,778	311,909,581	8.0	46.9	54.4	80.1
France.....	3,320,383	509,675	616,772	508,017	3.1	.2	.2	.1
Germany.....	7,266,443				6.9			
Mexico.....	5,848,310	3,261,507	1,488,636	1,033,087	5.5	1.2	.4	.3
Portugal.....	1,325,719	2,773,656	3,719,703	538,076	1.3	1.0	1.1	.1
United Kingdom.....	28,736,758	72,459,408	78,742,217	21,926,945	27.2	27.1	23.6	5.6
Other countries.....	3,095,621	6,957,563	9,207,708	11,669,381	2.9	2.6	2.9	3.0
Total.....	105,736,243	267,775,557	333,373,711	389,599,015	100.0	100.0	100.0	100.0
Wood:								
Cabinet woods, mahogany—	<i>M feet.</i>	<i>M feet.</i>	<i>M feet.</i>	<i>M feet.</i>				
British Africa.....	6,197	6,888	13,345	7,667	11.5	17.3	31.2	14.8
Central American States and British Honduras.....	14,237	10,450	12,701	27,098	26.5	26.2	29.7	52.4
Mexico.....	11,204	8,453	8,229	11,230	20.9	21.2	19.2	21.7
United Kingdom.....	15,050	7,248	1,360	78	28.0	18.2	3.2	.2
Other countries.....	6,996	6,816	7,145	5,608	13.1	17.1	16.7	10.9
Total.....	53,684	39,855	42,780	51,681	100.0	100.0	100.0	100.0
Boards, planks, deals, and other sawed lumber—								
Canada.....	937,069	1,180,018	1,155,916		96.5	96.8	98.3	
Other countries.....	33,955	38,398	19,403		3.5	3.2	1.7	
Total.....	971,024	1,218,416	1,175,319	1,282,747	100.0	100.0	100.0
Wood pulp:	<i>Pounds.</i>	<i>Pounds.</i>	<i>Pounds.</i>	<i>Pounds.</i>				
Canada.....	489,267,109	790,997,760	992,617,920	987,524,160	46.3	69.6	63.4	87.5
Germany.....	152,617,629	237,440			14.4			
Norway.....	163,293,971	115,978,240	99,957,760	16,914,240	15.5	10.2	6.4	1.5
Sweden.....	209,629,030	225,955,520	468,728,960	93,605,120	19.8	19.9	29.9	8.3
Other countries.....	42,013,747	2,618,560	5,519,360	31,158,400	4.0	.3	.3	2.7
Total.....	1,056,821,486	1,135,787,520	1,566,824,000	1,129,201,920	100.0	100.0	100.0	100.0



MISCELLANEOUS AGRICULTURAL STATISTICS.

CROP SUMMARY.

The December estimates of the Crop Reporting Board of the Bureau of Crop Estimates of the acreage production, and value (based on prices paid to farmers on December 1) of important farm crops of the United States in 1918 and 1917, with the average for the five years 1912-1916, based on the reports of the correspondents and agents of the Bureau, are as follows (1917 figures revised).

(N. B.—Production of tobacco, hops, beet seed, and all sugar, in pounds; cotton per acre in pounds, total in bales; cotton seed, hay, sugar beets, cabbage, and broom corn, in tons; apples, total, in bushels, commercial crop in barrels; cranberries in barrels; oranges in boxes; sorghum sirup in gallons; other products in bushels of weight.)

TABLE 256.—Crop summary, 1918, 1917, and average 1912-1916.

Crop.	Acreage.	Production.		Farm value Dec. 1.	
		Per acre.	Total.	Per unit.	Total.
Corn:				<i>Cents.</i>	<i>Dollars.</i>
1918.....	107,494,000	24.0	2,582,814,000	136.6	3,528,313,000
1917.....	116,730,000	26.3	3,065,233,000	127.9	3,920,228,000
Average 1912-1916.....	105,566,000	26.2	2,761,252,000	64.7	1,787,605,000
Winter wheat:					
1918.....	36,704,000	15.2	558,449,000	206.7	1,154,200,000
1917.....	27,257,000	15.1	412,901,000	202.8	837,237,000
Average 1912-1916.....	34,059,000	16.2	552,594,000	103.3	570,649,000
Spring wheat:					
1918.....	22,406,000	16.0	358,651,000	200.9	720,423,000
1917.....	17,832,000	12.5	223,754,000	197.0	440,875,000
Average 1912-1916.....	18,406,000	13.9	256,763,000	89.8	230,622,000
All wheat:					
1918.....	59,110,000	15.5	917,100,000	204.4	1,874,623,000
1917.....	45,089,000	14.1	636,655,000	200.8	1,278,112,000
Average 1912-1916.....	52,465,000	15.4	809,357,000	99.0	801,271,000
Oats:					
1918.....	44,400,000	34.6	1,538,359,000	71.0	1,092,423,000
1917.....	43,553,000	36.6	1,592,740,000	66.6	1,061,474,000
Average 1912-1916.....	39,456,000	32.9	1,296,406,000	40.2	821,386,000
Barley:					
1918.....	9,679,000	26.5	256,375,000	91.8	235,269,000
1917.....	8,933,000	23.7	211,759,000	113.7	240,758,000
Average 1912-1916.....	7,500,000	26.9	201,625,000	58.9	118,682,000
Rye:					
1918.....	6,185,000	14.4	89,103,000	151.5	134,947,000
1917.....	4,317,000	14.6	62,933,000	166.0	104,447,000
Average 1912-1916.....	2,711,000	16.4	44,547,000	86.0	38,327,000
Buckwheat:					
1918.....	1,040,000	16.5	17,182,000	166.4	28,585,000
1917.....	924,000	17.3	16,022,000	160.0	25,631,000
Average 1912-1916.....	807,000	19.0	15,336,000	79.6	12,209,000
Flaxseed:					
1918.....	1,938,000	7.6	14,657,000	340.2	49,870,000
1917.....	1,984,000	4.6	9,164,000	296.6	27,182,000
Average 1912-1916.....	1,930,000	9.1	17,600,000	148.7	26,174,000
Rice:					
1918.....	1,112,770	36.3	40,424,000	191.7	77,474,000
1917.....	980,900	35.4	34,739,000	189.6	65,879,000
Average 1912-1916.....	783,000	36.8	28,851,000	90.0	25,977,000
Potatoes:					
1918.....	4,210,000	95.0	400,106,000	119.5	478,136,000
1917.....	4,384,000	100.8	442,108,000	122.8	542,774,000
Average 1912-1916.....	3,678,000	98.4	361,753,000	70.8	256,248,000
Sweet potatoes:					
1918.....	922,000	93.6	86,334,000	135.4	116,867,000
1917.....	919,000	91.2	83,822,000	110.8	92,916,000
Average 1912-1916.....	663,000	95.8	63,541,000	72.9	46,313,000
Hay, tame:					
1918.....	55,971,000	1.36	76,069,000	\$20.04	1,524,307,000
1917.....	55,203,000	1.51	83,308,000	\$17.09	1,423,766,000
Average 1912-1916.....	50,892,000	1.51	76,798,000	\$11.38	873,883,000

TABLE 256.—Crop summary 1918, 1917, and average 1912-1916—Continued.

Crop.	Acreage.	Production.		Farm value Dec. 1.	
		Per acre.	Total.	Per unit.	Total.
Hay, wild:				<i>Cents.</i>	<i>Dollars.</i>
1918.....	15,283,000	.94	14,374,000	\$15.25	219,185,000
1917.....	16,212,000	.93	15,131,000	\$13.49	204,086,000
Average 1912-1916.....	16,790,000	1.11	18,573,000	\$7.91	146,940,000
All hay:					
1918.....	71,254,000	1.27	90,443,000	19.28	1,743,492,000
1917.....	71,415,000	1.38	98,439,000	16.54	1,627,852,000
Average 1912-1916.....	67,682,000	1.41	95,371,000	10.70	1,020,823,000
Tobacco:					
1918.....	1,549,000	865.1	1,340,019,000	27.9	374,318,000
1917.....	1,518,000	823.1	1,249,276,000	24.0	300,449,000
Average 1912-1916.....	1,290,000	801.2	1,033,357,000	11.5	118,782,000
Cotton:					
1918.....	35,890,000	155.9	11,700,000	27.6	1,616,207,000
1917.....	33,841,000	159.7	11,302,375	27.7	1,566,198,000
Average 1912-1916.....	34,920,000	182.6	13,327,317	12.0	796,511,000
Cotton seed:					
1918.....			5,350,000	\$65.01	347,804,000
1917.....			5,040,000	\$68.84	346,954,000
Average 1912-1916.....			5,940,000	\$28.33	168,261,000
Clover seed:					
1918.....	722,000	1.5	1,102,000	\$19.77	21,786,000
1917.....	821,000	1.8	1,488,000	\$12.84	19,107,000
Sugar beets:					
1918.....	594,010	9.92	5,889,840	\$10.00	58,905,000
1917.....	664,797	9.00	5,980,377	\$7.39	44,192,000
Average 1912-1916.....	579,063	10.30	5,972,000	\$5.76	34,378,000
Beet sugar:					
1918.....	594,010	2,576	1,530,126,000		
1917.....	664,797	2,302	1,530,414,000		
Average 1912-1916.....	579,063	2,655	1,537,155,000		
Cane sugar (La.):					
1918.....	231,200	2,430	561,800,000		
1917.....	244,000	1,997	487,200,000		
Average 1912-1916.....	212,400	2,129	452,148,000		
Maple sugar and sirup (as sugar):					
1918.....	¹ 19,298,200	² 2.72	53,512,500	³ 23.0	12,074,000
1917.....	¹ 17,466,400	² 2.58	45,127,400	³ 16.6	7,499,000
Sugar beet seed:					
1918.....	5,872	987	4,443,000		
1917.....	4,594	1,210	5,558,000		
Sorghum sirup:					
1918.....	372,600	78.4	29,224,000	95.9	28,035,000
1917.....	415,200	90.3	37,472,000	69.5	26,055,000
Average 1912-1916.....	158,925	88.6	14,073,000		
Beans (6 States):					
1918.....	1,754,000	10.1	17,733,000	\$5.28	93,639,000
1917.....	1,821,000	8.8	16,045,000	\$6.50	104,350,000
Peanuts:					
1918.....	2,291,900	24.3	55,597,000	172.4	95,829,000
1917.....	1,842,400	28.5	52,505,000	174.3	91,498,000
Grain sorghums (6 States):					
1918.....	5,619,000	11.8	66,396,000	150.4	99,848,000
1917.....	5,153,000	11.9	61,409,000	161.9	99,433,000
Broom corn (5 States):					
1918.....	333,000	.174	58,000	\$234.45	13,598,000
1917.....	345,000	.166	57,400	\$292.75	16,804,800
Onions (14 States):					
1918.....	35,830	375.1	13,438,200	121.1	16,268,000
1917.....	39,500	311.6	12,308,900	167.0	20,554,000
Cabbage (9 States):					
1918.....	61,700	9.2	565,200	\$26.22	14,818,000
1917.....	58,950	8.1	475,300	\$33.80	16,065,000
Hops (4 States):					
1918.....	27,900	723.8	20,193,000	19.6	3,958,000
1917.....	29,900	982.9	29,388,000	33.3	9,795,000
Cranberries (3 States):					
1918.....	27,200	12.9	350,100	\$10.84	3,794,000
1917.....	18,200	13.7	249,000	\$10.24	2,550,000
Apples, total:					
1918.....			173,632,000	132.5	229,990,000
1917.....			163,117,000	121.5	198,220,000
Average 1912-1916.....			213,685,000	74.3	158,853,000
Apples, commercial:					
1918.....			25,490,000	\$3.89	99,156,000
1917.....			22,630,000	\$3.65	82,600,000

¹ Trees tapped.² Per tree.³ May 15.

TABLE 256.—Crop summary 1918, 1917, and average 1912-1916—Continued.

Crop.	Acreage.	Production.		Farm value Dec. 1.	
		Per acre.	Total.	Per unit.	Total.
Peaches:				<i>Cents.</i>	<i>Dollars.</i>
1918.....			39,149,000	165.6	64,831,000
1917.....			45,066,000	135.9	61,245,600
Average 1912-1916.....			49,552,000	101.8	50,431,000
Pears:					
1918.....			10,342,000	137.3	14,200,000
1917.....			13,281,000	115.8	15,379,600
Average 1912-1916.....			11,425,000	86.6	9,899,000
Oranges (2 States):					
1918.....			19,587,000	473.3	92,723,000
1917.....			10,593,000	260.1	27,556,000
Total:					
1918.....	356,859,962				12,562,624,000
1917.....	346,045,441				11,961,156,000

STATES LEADING IN STAPLE CROPS.

TABLE 257.—Production of staple crops in leading States, millions of bushels, 1916-1918.

Crop.	1918		1917		1916	
	<i>Million bushels.</i>		<i>Million bushels.</i>		<i>Million bushels.</i>	
Corn.....	Iowa.....	376	Illinois.....	418	Iowa.....	367
Wheat.....	Kansas.....	192	North Dakota.....	56	Kansas.....	98
Oats.....	Iowa.....	230	Iowa.....	254	Iowa.....	189
Barley.....	Minnesota.....	43	California.....	39	California.....	33
Rye.....	North Dakota.....	20	North Dakota.....	10	Wisconsin.....	6
Rice.....	Louisiana.....	18	Louisiana.....	16	Louisiana.....	20
Buckwheat.....	Pennsylvania.....	6	New York.....	6	Pennsylvania.....	4
Kafirs (sorghum grains).....	Texas.....	24	Oklahoma.....	22	Texas.....	26
Potatoes.....	New York.....	35	New York.....	38	Maine.....	26
Sweet potatoes.....	Alabama.....	15	Alabama.....	14	North Carolina.....	9
Flaxseed.....	North Dakota.....	7	North Dakota.....	4	North Dakota.....	8
Beans (dry).....	California.....	9	California.....	8	California.....	6
Peanuts.....	Alabama.....	17	Alabama.....	14	Texas.....	9
Apples (commercial).....	New York.....	21	Washington.....	15	New York.....	21
Peaches.....	California.....	12	California.....	14	California.....	12
	<i>Thousand tons.</i>		<i>Thousand tons.</i>		<i>Thousand tons.</i>	
Hay (all).....	New York.....	5,425	New York.....	6,413	New York.....	7,151
Broom corn.....	Texas.....	19	Oklahoma.....	26	Oklahoma.....	22
Sugar beets.....	Colorado.....	1,444	Colorado.....	1,858	Colorado.....	2,018
	<i>Thousand bales.</i>		<i>Thousand bales.</i>		<i>Thousand bales.</i>	
Cotton.....	Texas.....	2,580	Texas.....	3,125	Texas.....	3,726
	<i>Million pounds.</i>		<i>Million pounds.</i>		<i>Million pounds.</i>	
Tobacco.....	Kentucky.....	428	Kentucky.....	441	Kentucky.....	436

CROP VALUE COMPARISONS.

TABLE 258.—Value of 13 crops and hypothetical value of all crops, with rank, 1909–1918.

[The following tabulation gives the estimated total value of 13 crops—corn, wheat, oats, barley, rye, buckwheat, flaxseed, rice, potatoes, sweet potatoes, tame hay, tobacco, and lint cotton—in the United States, by States, in 1918, 1917, 1912–1916, and 1909; the value of all crops in 1909 (census); and the hypothetical value of all crops in other years, based upon ratio of the 13 crops to all crops in census year; also rank of States. The slight differences in the total value of crops in the United States between Tables 258 and 259 are due to different methods of estimating. In Table 258 a more detailed method is used than is practicable in Table 259, where each state is shown separately.]

State.	Value 13 crops (000 omitted).			Value all crops 1909 (census, 000 omitted).	Ratio value 13 crops to all crops in census 1909.	Hypothetical value of all crops (000 omitted).			Rank.	
	1918	1917	1909			1918	1917	1912-16 5-year average.	1918	
									13 crops.	All crops.
Me.....	\$56,381	\$48,704	\$27,836	\$39,318	71	\$79,410	\$68,597	\$59,775	36	37
N. H.....	17,270	14,790	9,233	15,976	58	29,776	25,500	21,666	46	45
Vt.....	34,594	30,249	18,577	27,447	68	50,874	44,484	38,318	41	42
Mass.....	32,996	30,498	14,916	31,948	47	70,204	64,889	44,766	42	38
R. I.....	4,142	4,282	2,030	3,937	52	7,965	8,235	4,906	48	43
Conn.....	39,576	35,868	14,872	22,488	66	59,964	54,345	33,315	40	40
N. Y.....	281,746	263,396	132,620	209,168	63	447,216	418,089	259,494	19	11
N. J.....	59,926	59,802	23,396	40,341	58	103,321	103,107	58,510	35	35
Pa.....	358,745	317,937	130,010	163,740	78	459,929	407,612	239,453	12	10
Del.....	18,929	19,949	6,543	9,122	72	26,290	27,707	13,047	45	46
Md.....	91,606	88,105	31,454	43,920	72	127,231	122,368	59,851	32	32
Va.....	228,779	215,711	71,153	100,531	71	322,224	303,818	145,803	24	25
W. Va.....	97,320	87,276	27,749	40,375	69	141,043	126,487	66,930	30	30
N. C.....	386,955	312,547	102,783	142,890	72	537,438	434,093	209,431	9	7
S. C.....	343,661	295,028	109,699	141,983	77	446,313	383,153	166,508	15	14
Ga.....	460,428	431,676	176,959	226,595	78	590,292	553,431	263,859	6	2
Fla.....	42,289	39,589	14,932	36,142	41	103,144	96,559	47,932	38	36
Ohio.....	465,604	470,535	197,288	230,338	86	541,400	547,134	250,674	5	6
Ind.....	451,731	448,827	181,234	204,210	89	507,563	504,300	222,610	7	8
Ill.....	809,305	781,991	342,861	372,270	92	879,679	849,990	373,918	1	1
Mich.....	239,035	252,154	114,808	162,005	71	336,669	355,146	194,082	23	22
Wis.....	342,668	301,243	121,048	148,359	82	417,888	367,370	194,944	16	15
Minn.....	489,414	403,936	168,706	193,451	87	562,545	464,294	225,185	4	5
Iowa.....	747,947	721,282	287,065	314,666	91	821,920	792,618	580,979	2	2
Mo.....	410,071	456,303	188,524	220,664	85	482,436	536,827	233,212	8	9
N. Dak.....	349,309	204,870	168,292	180,636	93	375,601	220,290	165,561	13	19
S. Dak.....	381,826	312,111	109,353	125,507	87	438,880	358,748	140,118	10	13
Nebr.....	344,031	459,524	173,512	196,126	88	390,944	522,186	243,872	14	17
Kans.....	373,382	366,278	189,091	214,860	88	424,298	416,225	250,392	11	14
Ky.....	315,754	290,179	114,202	138,973	82	385,066	353,877	158,011	17	18
Tenn.....	249,677	222,333	93,341	120,706	77	324,256	288,744	158,129	21	24
Ala.....	275,008	215,954	108,095	144,287	75	366,677	287,939	176,141	20	20
Miss.....	294,766	256,281	107,054	147,316	73	403,789	351,070	166,048	18	16
La.....	175,237	176,473	47,577	77,336	62	282,640	284,634	126,074	26	26
Tex.....	570,434	648,557	244,721	298,133	82	695,651	790,923	492,908	3	3
Okla.....	222,182	285,941	112,344	133,454	84	264,502	340,406	172,381	25	27
Ark.....	241,980	291,312	86,611	119,419	73	331,479	371,660	160,238	22	23
Mont.....	110,035	79,309	22,394	29,715	75	146,713	105,745	75,979	29	29
Wyo.....	46,314	40,685	7,508	10,023	75	61,752	54,247	23,833	37	39
Colo.....	95,256	102,232	31,416	50,975	62	153,639	164,890	76,565	31	28
N. Mex.....	25,648	24,236	5,591	8,922	63	40,711	38,470	16,256	44	44
Ariz.....	30,855	22,771	3,993	5,497	73	42,267	31,193	12,140	43	43
Utah.....	40,522	38,701	13,682	18,485	74	54,759	52,299	28,895	39	41
Nev.....	16,930	16,889	4,082	5,924	69	24,536	24,477	14,381	47	47
Idaho.....	89,973	81,081	28,816	34,358	84	107,111	96,525	50,068	33	34
Wash.....	110,909	118,426	64,340	78,927	82	135,255	144,422	97,198	28	31
Oreg.....	83,287	73,457	33,140	49,041	68	122,481	108,025	72,254	34	33
Calif.....	171,563	206,575	71,994	153,111	47	365,028	439,521	214,613	27	21
U. S.....	11,125,996	10,645,853	4,357,445	5,486,615	79.4	14,090,769	13,506,669	6,907,313

VALUE OF FARM PRODUCTS.

TABLE 259.—Estimated value of farm products, 1879–1918, based on prices at the farm.

Year.	Total, gross (to be read as index numbers).	Crops.		Animals and animal products.	
		Value.	Per- centage of total.	Value.	Per- centage of total.
1879 (census).....	\$2,212,540,927				
1889 (census).....	2,460,107,454				
1897.....	3,961,000,000	\$2,519,000,000	63.6	\$1,442,000,000	36.4
1898.....	4,339,000,000	2,760,000,000	63.6	1,579,000,000	36.4
1899 (census).....	4,717,069,973	2,998,704,412	63.6	1,718,000,000	36.4
1900.....	5,010,000,000	3,192,000,000	63.7	1,818,000,000	36.3
1901.....	5,302,000,000	3,385,000,000	63.8	1,917,000,000	36.2
1902.....	5,595,000,000	3,578,000,000	64.0	2,016,000,000	36.0
1903.....	5,887,000,000	3,772,000,000	64.1	2,116,000,000	35.9
1904.....	6,122,000,000	3,982,000,000	65.0	2,140,000,000	35.0
1905.....	6,274,000,000	4,013,000,000	64.0	2,261,000,000	36.0
1906.....	6,764,000,000	4,263,000,000	63.0	2,501,000,000	37.0
1907.....	7,488,000,000	4,761,000,000	63.6	2,727,000,000	36.4
1908.....	7,891,000,000	5,098,000,000	64.6	2,792,000,000	35.4
1909 (census).....	8,558,161,223	5,487,161,223	64.1	3,071,000,000	35.9
1910.....	9,037,000,000	5,486,000,000	60.7	3,551,000,000	39.3
1911.....	8,819,000,000	5,562,000,000	63.1	3,257,000,000	36.9
1912.....	9,343,000,000	5,842,000,000	62.5	3,501,000,000	37.5
1913.....	9,850,000,000	6,133,000,000	62.3	3,717,000,000	37.7
1914.....	9,895,000,000	6,112,000,000	61.8	3,783,000,000	38.2
1915.....	10,775,000,000	6,907,000,000	64.1	3,868,000,000	35.9
1916.....	13,406,000,000	9,054,000,000	67.5	4,352,000,000	32.5
1917.....	19,331,000,000	13,479,000,000	69.7	5,852,000,000	30.3
1918 (preliminary).....	21,386,000,000	14,222,000,000	66.5	7,164,000,000	33.5

WORLD PRODUCTION AND EXPORT TRADE.

TABLE 260.—Production and export trade of the world in important crops, average, 1909–1913, in millions, 000,000 omitted.

[Substantially the total production and exports for the world. However, China's probably large cotton production, also some minor items of production and exports for other countries, are omitted owing to lack of trustworthy information. One short ton=2,000 pounds.]

Crop.	Production.		Exports.			
	World.	United States production.	World.	Contributed by United States.	World crop exported.	United States crop exported.
Wheat..... bushels..	3,726	<i>Per cent.</i> 18	745	<i>Per cent.</i> 13	<i>Per cent.</i> 20	<i>Per cent.</i> 15
Corn..... do.....	3,807	71	271	17	7	2
Oats..... do.....	4,324	26	1,234	15	15	11
Barley..... do.....	1,468	12	1,390	3	120	14
Rye..... do.....	1,788	2	1,108	10.8	16	12
Potatoes..... do.....	5,471	6	1,75	12	11	10.5
Tobacco..... pounds..	2,712	37	929	41	34	38
Rice..... do.....	110,780	0.6	12,721	0.1	11	2
Cotton..... 500-pound bales..	21.1	62	14.0	64	66	69
Sugar..... short tons..	18.7	5	7.5	0.5	40	4

¹ Three-year average, 1911–1913.

FOREIGN TRADE IN FOODSTUFFS.

TABLE 261.—Values of exports and imports of foodstuffs, in millions of dollars, 1912–1918.

	1918	1917	1916	1915	1914	1913	1912
Exports of foodstuffs:							
In crude condition, and food animals.....	548	509	421	462	275	170	138
Partly or wholly manufactured.....	1,406	807	648	551	399	325	309
Total.....	1,954	1,316	1,069	1,013	584	495	447
Imports of foodstuffs:							
In crude condition, and food animals.....	346	386	260	243	235	221	237
Partly or wholly manufactured.....	397	351	339	273	256	198	206
Total.....	743	737	599	516	491	419	443
Net exports.....	1,211	579	470	497	93	76	4

CORN.

TABLE 262.—White, yellow, and mixed corn; percentage of each in crops of 1917 and 1918.

State.	White.		Yellow.		Mixed.		Bushels, 1918 (000 omitted).		
							White.	Yellow.	Mixed.
	P. ct.	P. ct.	P. ct.	P. ct.	P. ct.	P. ct.			
Maine.....	25	0	75	100	0	0	304	911	0
New Hampshire.....	0	19	100	86	0	4	0	1,260	0
Vermont.....	6	25	87	75	7	0	192	1,488	120
Massachusetts.....	13	10	60	83	27	7	270	1,248	562
Rhode Island.....	86	70	10	29	4	10	492	57	23
Connecticut.....	17	21	63	69	20	10	476	1,764	560
New York.....	23	25	65	59	12	16	6,790	19,188	3,542
New Jersey.....	13	15	56	47	31	38	1,487	6,466	3,546
Pennsylvania.....	20	20	60	62	20	18	12,480	37,440	12,480
Delaware.....	35	35	55	54	10	11	2,550	4,607	728
Maryland.....	50	39	44	50	6	11	12,005	19,564	1,441
Virginia.....	72	67	18	22	10	11	40,320	16,880	5,600
West Virginia.....	39	37	44	52	17	11	9,672	16,912	4,216
North Carolina.....	72	72	11	11	17	17	46,343	7,680	10,942
South Carolina.....	70	78	18	14	12	8	26,775	6,885	4,590
Georgia.....	81	80	10	9	9	11	55,769	6,885	6,196
Florida.....	80	82	8	8	12	10	11,264	1,126	1,690
Ohio.....	24	21	62	64	14	15	31,968	82,584	18,648
Indiana.....	31	30	53	57	16	13	52,562	89,863	27,129
Illinois.....	38	37	50	51	12	12	133,551	175,725	42,174
Michigan.....	24	26	57	58	19	16	11,592	27,531	9,177
Wisconsin.....	25	31	50	45	25	24	17,384	34,770	17,384
Minnesota.....	29	29	49	54	22	17	31,900	53,900	24,200
Iowa.....	27	28	59	56	14	16	101,419	221,618	52,587
Missouri.....	38	37	48	47	14	16	50,867	64,253	18,740
North Dakota.....	39	32	32	27	29	41	3,586	2,943	2,667
South Dakota.....	28	34	54	52	18	14	30,283	58,421	19,474
Nebraska.....	39	38	40	43	21	19	48,004	49,234	25,848
Kansas.....	45	44	34	33	21	23	19,585	14,798	9,140
Kentucky.....	64	66	22	22	14	12	59,904	20,592	13,104
Tennessee.....	72	72	13	14	15	14	60,480	10,920	12,600
Alabama.....	72	73	11	11	17	16	48,734	7,445	11,507
Mississippi.....	73	72	13	12	14	16	48,399	8,619	9,282
Louisiana.....	49	46	30	28	21	26	14,504	8,880	6,216
Texas.....	45	41	28	32	27	27	31,650	19,320	18,630
Oklahoma.....	44	38	24	30	32	32	10,725	5,850	7,800
Arkansas.....	63	63	20	19	17	18	22,113	7,020	5,967
Montana.....	22	26	30	36	48	38	462	630	1,008
Wyoming.....	16	29	39	17	45	54	160	390	450
Colorado.....	31	38	38	34	31	28	3,431	4,295	3,431
New Mexico.....	38	38	36	30	26	32	1,615	1,530	1,105
Arizona.....	28	53	67	40	5	7	266	638	48
Utah.....	54	55	34	34	12	11	363	228	81
Nevada.....	60	92	30	8	10	39	19	6
Idaho.....	39	40	50	40	11	20	359	460	101
Washington.....	43	32	42	55	15	13	703	686	245
Oregon.....	24	30	68	50	8	20	327	928	109
California.....	61	60	30	36	9	4	1,815	892	268
United States.....	41.2	41.9	42.7	42.1	16.1	16.0	1,065,259	1,102,193	415,362

STANDARDS FOR SHELLED CORN.

[Tabulated and abridged description of the official grain standards of the United States for shelled corn under the United States Grain Standards Act, as established and promulgated by the Secretary of Agriculture April 13, 1918, effective July 15, 1918. (Compiled from Service and Regulatory Announcements (Markets), No. 33, "Official Grain Standards of the United States for Shelled Corn.")]

CLASSES OF SHELLED CORN.

Shelled corn shall be divided into three classes, as follows:

White corn.—This class shall consist of corn of which at least 98 per cent by weight of the kernels are white. A slight tinge of light straw color or of pink on kernels of corn otherwise white shall not affect their classification as white corn.

Yellow corn.—This class shall consist of corn of which at least 95 per cent by weight of the kernels are yellow. A slight tinge of red on kernels of corn otherwise yellow shall not affect their classification as yellow corn.

Mixed corn.—This class shall consist of corn of various colors not coming within the limits for color as provided in the definitions of white corn and yellow corn. White-capped yellow kernels shall be classified as mixed corn.

TABLE 263.—Standards for grades of shelled corn.

[The numbered footnotes below must be read in connection with the tabulation.]

Grade No.	Minimum test weight per bushel.	Maximum limits of—			
		Moisture.	Foreign material and cracked corn.	Damaged kernels.	
				Total.	Heat damage.
	<i>Pounds.</i>	<i>Per cent.</i>	<i>Per cent.</i>	<i>Per cent.</i>	<i>Per cent.</i>
1.....	55	14.0	2	2	0.0
2.....	53	15.5	3	4	0.1
3.....	51	17.5	4	6	0.3
4.....	49	19.5	5	8	0.5
5.....	47	21.5	6	10	1.0
6.....	44	23.0	7	15	3.0
Sample. ¹					

¹ **SAMPLE GRADE.**—Shall be white corn, or yellow corn, or mixed corn, respectively, which does not come within the requirements of any of the grades from No. 1 to No. 6, inclusive, or which has any commercially objectionable foreign odor, or is heating, hot, infested with live weevils or other insects injurious to stored grain, or is otherwise of distinctly low quality.

(1) The corn in grades Nos. 1 to 5, inclusive, shall be cool and sweet. The corn in grade No. 6 shall be cool, but may be musty or sour.

DEFINITION OF TERMS.

The following definitions of terms are for the purposes of the official grain standards of the United States for shelled corn (maize):

Corn.—Corn shall be shelled corn of the flint or dent varieties.

Basis of determinations.—Each determination of color, damage, and heat damage shall be upon the basis of the grain after the removal of foreign material and cracked corn as provided in the section defining foreign material and cracked corn. All other determinations shall be upon the basis of the grain including such foreign material and cracked corn.

Percentages.—Percentages, except in the case of moisture, shall be percentages ascertained by weight.

Percentage of moisture.—Percentage of moisture in corn shall be that ascertained by the moisture tester and the method of use thereof described in Circular No. 72, and supplement thereto, issued by the United States Department of Agriculture, Bureau of Plant Industry, or ascertained by any device and method giving equivalent results.

Test weight per bushel.—Test weight per bushel shall be the weight per Winchester bushel as determined by the testing apparatus and the method of use thereof described in Bulletin No. 472, dated October 30, 1916, issued by the United States Department of Agriculture, or as determined by any device and method giving equivalent results.

Foreign material and cracked corn.—Foreign material and cracked corn shall be kernels and pieces of kernels of corn, and all matter other than corn, which will pass through a metal sieve perforated with round holes fourteen sixty-fourths of an inch in diameter, and all matter other than corn remaining on such sieve after screening.

Heat-damaged kernels.—Heat-damaged kernels shall be kernels and pieces of kernels of corn which have been distinctly discolored by external heat or as a result of heating caused by fermentation.

SEED CORN.

In May the Bureau of Crop Estimates asked its county reporters to estimate the percentage of the corn farmers who tested their seed corn this year and in a usual year, the percentage germination of the seed this year and a usual year, and probable amount of replanting this year and a usual year.

For the entire United States the reports as received indicate that 54 per cent of corn growers tested their seed this year, whereas usually 26 per cent test their corn. The germination was 80 per cent this year and 90 per cent the usual. The necessary replanting is 18 per cent this year, compared with 10 per cent the usual. About 7 per cent more seed is used to the acre than usual. Estimates for important corn States are given below:

TABLE 264.—Per cent of growers who test their seed, per cent germinating, and per cent of replanting, 1918 and usual.

State.	Per cent of corn growers who test their seed.		Per cent of seed germinating.		Per cent of replanting.	
	1918	Usual.	1918	Usual.	1918	Usual.
New York.....	75	32	56	92	10	8
New Jersey.....	48	23	82	90	19	25
Pennsylvania.....	59	26	64	81	23	8
Delaware.....	20	5	90	95	60	50
Maryland.....	18	10	80	91	23	17
Virginia.....	37	8	80	90	29	9
West Virginia.....	59	25	58	90	43	16
North Carolina.....	14	7	89	91	28	21
South Carolina.....	10	9	91	90	12	13
Georgia.....	9	6	91	92	9	9
Ohio.....	78	25	64	92	27	9
Indiana.....	80	29	75	92	29	18
Illinois.....	85	37	80	92	21	12
Michigan.....	78	42	70	88	20	11
Wisconsin.....	92	64	84	92	12	9
Minnesota.....	91	67	79	92	9	5
Iowa.....	86	58	82	92	10	8
Missouri.....	55	18	79	92	33	20
North Dakota.....	78	68	70	89	0	4
South Dakota.....	92	50	77	90	14	5
Nebraska.....	78	33	75	89	11	7
Kansas.....	63	24	81	93	16	9
Kentucky.....	50	10	63	90	35	14
Tennessee.....	15	7	79	92	33	19
Alabama.....	10	7	90	88	12	14
Mississippi.....	10	7	91	86	13	12
Louisiana.....	21	5	87	87	12	14
Texas.....	20	13	88	91	7	7
Oklahoma.....	29	19	89	86	11	9
Arkansas.....	16	17	89	88	16	14
United States.....	54	26	80	90	17.7	11.4

MONTHLY MARKETINGS.

TABLE 265.—Corn: Monthly marketings by farmers, 1913-1918.

Month.	Estimated amount sold monthly by farmers of United States (millions of bushels).					Per cent of year's sales.				
	1917-18	1916-17	1915-16	1914-15	1913-14	1917-18	1916-17	1915-16	1914-15	1913-14
July.....	34	30	31	19	27	5.3	6.2	5.6	3.9	5.8
August.....	26	34	33	34	16	4.0	7.1	5.9	7.1	3.3
September.....	22	28	35	23	21	3.4	5.9	6.4	4.7	4.5
October.....	24	25	33	23	37	3.8	5.3	6.0	4.7	7.9
November.....	56	67	57	71	85	8.8	14.0	10.4	14.7	17.8
December.....	78	60	88	82	102	12.2	12.5	15.9	16.8	21.4
January.....	91	73	64	96	51	14.2	15.1	11.7	19.8	10.7
February.....	103	43	68	38	34	16.1	9.0	12.4	7.8	7.1
March.....	88	34	39	22	30	13.7	7.0	7.1	4.6	6.3
April.....	45	26	35	27	21	7.1	5.4	6.4	5.0	4.4
May.....	36	31	35	21	29	5.6	6.5	6.3	4.4	6.2
June.....	37	29	32	29	22	5.8	6.0	5.9	5.9	4.6
Season.....	640	480	550	485	475	100.0	100.0	100.0	100.0	100.0

HOW THE CORN CROP IS HARVESTED.

The corn crop is the most important and widely grown crop of the United States, but the method of harvesting it differs in different parts of the country. In 1913 the county reporters of the Bureau of Crop Estimates were asked to estimate, on schedules provided, what percentage of the crop of their county is harvested or handled in the manner indicated in the table below. The replies, averaged by States, may be regarded as representing broadly the practice in each State; some, although no important, change has probably occurred since this information was gathered.

TABLE 266.—Percentages of corn crop harvested by the different methods, by States.

State.	Per cent of corn area cut—			Percentage of matured grain gathered by—						Of corn stalks left standing, percentage stalks—			Average tons stover per acre.
	Green, for silos.	Green feed.	Matured for grain.	Snapping.	Out, shocked in field.	Out, hauled to barn to husk.	Stock turned in standing corn.	Other.	Burned.	Pastured.	Plowed under.		
	P. c.	P. c.	P. c.	P. c.	P. c.	P. c.	P. c.	P. c.	P. c.	P. c.	P. c.	P. c.	
Maine.....	35	15	50	100	3.0	
New Hampshire.....	65	6	29	7	93	50	50	3.0	
Vermont.....	74	5	21	11	64	25	3.0	
Massachusetts.....	58	10	32	11	59	30	15	75	10	
Rhode Island.....	37	8	55	3	90	7	3.0	
Connecticut.....	55	3	42	19	55	12	14	100	3.2	
New York.....	49	9	42	45	55	100	4.0	
New Jersey.....	9	6	85	4	93	2	1	52	48	
Pennsylvania.....	20	5	75	2	80	14	1	3	61	39	2.4	
Delaware.....	10	2	88	90	10	1.0	
Maryland.....	7	7	86	29	52	9	2	8	25	45	30	1.5	
Virginia.....	8	7	85	17	63	17	2	1	12	31	57	1.5	
West Virginia.....	7	4	89	5	84	5	1	5	21	56	23	2.0	
North Carolina.....	2	8	90	83	7	9	1	13	12	75	1.3	
South Carolina.....	2	5	93	92	4	3	1	29	20	51	1.0	
Georgia.....	2	5	93	94	3	2	1	19	26	55	1.4	
Florida.....	2	6	92	90	2	2	1	5	16	40	44	1.3	
Ohio.....	10	5	85	9	70	18	2	1	11	63	26	2.4	
Indiana.....	10	15	75	36	45	11	3	5	7	68	25	2.6	
Illinois.....	9	10	81	55	28	11	3	3	14	56	30	3.2	
Michigan.....	28	13	59	2	66	24	3	5	3	66	31	3.0	
Wisconsin.....	36	18	46	8	50	30	1	11	65	35	2.9	
Minnesota.....	11	20	69	35	32	15	6	12	7	65	28	2.5	
Iowa.....	6	10	84	70	10	8	2	10	5	79	16	2.9	
Missouri.....	10	22	68	36	40	9	4	11	16	61	23	2.9	
North Dakota.....	10	50	40	19	17	39	8	17	1	94	5	2.5	
South Dakota.....	6	10	84	47	32	13	4	4	1	56	43	2.0	
Nebraska.....	4	12	84	44	19	13	3	21	4	63	33	2.0	
Kansas.....	14	16	70	46	31	8	3	12	7	70	23	3.2	
Kentucky.....	6	14	80	29	58	9	3	1	11	55	34	2.0	
Tennessee.....	5	6	89	70	19	7	3	1	20	40	40	1.8	
Alabama.....	2	7	91	92	4	2	1	1	16	44	40	1.4	
Mississippi.....	3	5	92	96	1	1	1	1	21	30	49	1.6	
Louisiana.....	2	7	91	92	1	1	6	25	45	30	2.0	
Texas.....	5	4	91	88	5	5	1	1	13	45	42	1.6	
Oklahoma.....	6	10	84	65	10	10	6	9	7	67	26	1.6	
Arkansas.....	5	10	85	89	8	2	1	27	52	21	1.5	
Montana.....	60	40	23	44	33	100	2.5	
Wyoming.....	3	47	50	34	22	40	2	2	95	5	3.0	
Colorado.....	10	35	55	63	14	17	3	3	7	74	19	2.5	
New Mexico.....	3	22	75	51	24	17	3	5	1	85	14	3.0	
Arizona.....	5	6	89	70	15	8	7	40	30	30	
Utah.....	100	4	33	63	100	
Nevada.....	15	85	100	90	10	
Idaho.....	20	15	65	34	28	8	7	23	5	65	30	
Washington.....	33	22	45	28	16	36	19	1	28	28	44	
Oregon.....	22	26	52	49	9	14	4	24	20	80	
California.....	7	14	79	54	38	6	2	38	38	24	
United States.....	8.1	10.9	81.0	57.7	24.9	9.1	2.6	5.7	11.8	54.7	33.5	2.2	

USES MADE OF CORN CROP.

[NOTE.—The following article is copied from the Crop Reporter of January, 1913, because many inquiries are being made as to the uses made of the corn crop. Although the estimates were made about six years ago, the proportions have not changed materially since then. The average yearly production of corn in the past five years was 2,764,000,000 bushels, which is but slightly larger than the figure to which the percentages are applied in the article below. The average exports in the past five years are almost the same as given in the article.]

The corn crop is by far the most valuable single crop grown in the United States. It is distinctly an American crop, about 75 per cent of the "world" yearly production of approximately three and a half billion bushels being grown in the United States. What becomes of this vast quantity of corn is frequently asked. Answers to inquiries sent to crop correspondents of the Bureau of Crop Estimates of the United States Department of Agriculture permit some interesting deductions to be made upon this subject.

The average annual production of corn in the United States in the last few years (not including the bumper crop of 1912) was about 2,700,000,000 bushels. Of this it is estimated that about 26 per cent, or 702,000,000 bushels, were marketed, 8 per cent (216,000,000 bushels) remaining in the near-by towns, 11 per cent (297,000,000 bushels) going to distant towns or for export, and 7 per cent (189,000,000 bushels) going to distant farms.

TABLE 267.—Estimated disposition of the corn crop as used in towns.

Use.	Bushels.	Per cent of total crop.
Used in flour and grist mills (census).....	245,000,000	9.1
Used in the manufacture of glucose and starch.....	40,000,000	1.5
Used in manufacture of distilled liquors, 1910.....	21,000,000	.8
Used in manufacture of malt liquors.....	14,000,000	.5
Used for feed in towns.....	120,000,000	4.4
Exported.....	45,000,000	1.7
Balance indefinite.....	28,000,000	1.0
Total.....	513,000,000	19.0

Of the quantity exported, less than 2,000,000 bushels were in the form of meal.

Of the 245,000,000 bushels used in flour and grist mills, a portion returns to the farm for consumption. This quantity may be estimated at about 125,000,000 bushels. If we include this quantity, 125,000,000 bushels, with the farm consumption, the total farm consumption would be about 2,312,000,000 bushels, or 85.6 per cent of the total crop.

Of the total "farm" consumption, it is estimated that horses and mules consumed 31.5 per cent, swine 31.3 per cent, cattle other than milch cows 11 per cent, milch cows 10 per cent, poultry 4.2 per cent, human beings 4 per cent, sheep 2.6 per cent, seed 1 per cent, balance (for other or doubtful purposes) 4.4 per cent. Applying these percentages to the 2,312,000,000 bushels, the estimated total farm consumption of recent years gives the following totals and percentages of the entire crop:

TABLE 268.—Estimated disposition of the corn crop as used on farms.

Use.	Bushels.	Per cent of entire crop.
Horses and mules.....	728,000,000	27.0
Swine.....	724,000,000	26.8
Cattle (other than milch).....	254,000,000	9.4
Milch cows.....	231,000,000	8.6
Poultry.....	97,000,000	3.6
Human beings.....	92,000,000	3.4
Sheep.....	60,000,000	2.2
Seed.....	23,000,000	.8
Other, or doubtful.....	103,000,000	3.8
Total.....	2,312,000,000	85.6

The proportion of the crop utilized for different purposes varies from year to year, according to the size of the crop. For instance, when the crop is large a relatively larger proportion is consumed by meat-producing animals, the proportion used by swine increasing more than that used by horses because the number of horses is more uniform from year to year than the number of swine. The estimated production in 1912 is large, 3,124,000,000 bushels—424,000,000 bushels more than the 2,700,000,000 to which the percentages above are applied. Hence, of this year's crop a larger percentage than given above will probably be consumed by meat-producing animals.

SILOS IN THE UNITED STATES.

About 400,000 silos are believed to be in the United States, with a total capacity of about 31,000,000 tons, an average of nearly 78 tons per silo. About 10 tons of silage can be obtained from one acre. No census has ever been made of the number of silos, therefore the crop reporters of the Bureau of Crop Estimates have made estimates for their respective localities. Silos are on about 6 per cent of the farms of the United States; they are most numerous in the dairy sections of the North and East. Their number is increasing rapidly. Ohio assessors' returns indicate 11,380 silos in that State in 1913, 15,068 in 1914, and about 19,632 in 1915. Indiana assessors' reports indicate 20,306 in March, 1915, and 25,631 in 1916. It is reasonable to believe that the number of silos is increasing in the United States at a rate of 10 per cent or more a year.

TABLE 269.—*Estimated number and capacity of silos in important States.*

State.	Number of silos.	Average capacity.	Total capacity.
		<i>Tons.</i>	<i>Tons.</i>
New York.....	55,000	75	4,125,000
Pennsylvania.....	24,000	65	1,560,000
Ohio.....	25,000	67	1,675,000
Indiana.....	27,000	70	1,890,000
Illinois.....	30,000	79	2,370,000
Michigan.....	33,000	70	2,310,000
Wisconsin.....	55,000	87	4,785,000
Minnesota.....	15,000	95	1,425,000
Iowa.....	16,000	105	1,680,000
Missouri.....	13,000	90	1,170,000
Kansas.....	11,000	106	1,166,000
Kentucky.....	10,000	80	800,000
New England.....	35,000	67	2,345,000
All other.....	55,000	77	4,235,000
United States.....	404,000	78	31,536,000

CORN AND HOGS.

TABLE 270.—*Corn and hog prices compared: Number of bushels of corn purchasable with 100 pounds of hogs, based on prices monthly.*

State and division.	Jan. 15.		Feb. 15.		Mar. 15.		Apr. 15.		May 15.		June 15.		July 15.		Aug. 15.		Sept. 15.		Oct. 15.		Nov. 15.		Dec. 15.		
	1918	1910-1914	1918	1910-1914	1918	1910-1914	1918	1910-1914	1918	1910-1914	1918	1910-1914	1918	1910-1914	1918	1910-1914	1918	1910-1914	1918	1910-1914	1918	1910-1914	1918	1910-1914	
North Atlantic Division	8.9	11.2	8.7	11.3	8.4	11.4	8.4	11.4	8.8	11.5	8.7	10.3	9.0	10.1	9.6	10.1	10.0	10.2	10.6	10.8	10.6	10.8	10.6	10.6	10.7
Delaware	11.5	13.8	9.9	12.7	10.1	12.1	9.1	12.0	9.8	11.3	12.1	8.4	11.0	10.0	10.3	10.2	11.2	10.9	12.8	12.4	13.8	13.3	14.1	14.1
Maryland	10.6	11.7	9.3	11.7	9.0	11.8	9.8	12.2	9.7	10.7	10.1	10.1	9.8	10.7	10.2	10.3	10.3	10.2	11.1	11.2	11.4	13.0	11.6	12.5	12.5
Virginia	9.6	10.0	8.9	9.7	8.4	9.8	8.4	9.4	8.4	9.0	8.1	8.4	7.8	7.8	8.0	8.0	8.5	8.6	8.9	9.3	9.4	9.9	10.1	10.1	10.1
West Virginia	9.2	9.9	8.2	9.7	7.9	10.1	7.6	9.8	7.6	9.1	7.3	9.0	7.4	8.3	7.4	8.8	8.5	9.1	9.0	9.6	8.9	9.7	8.7	9.8	9.8
North Carolina	10.2	8.9	9.6	8.7	9.1	8.4	9.0	8.8	8.2	8.1	8.5	8.1	8.7	8.0	8.5	7.9	8.6	8.0	9.1	8.8	10.3	9.4	10.4	9.0	9.0
South Carolina	9.1	8.8	8.8	8.2	7.9	8.0	7.5	8.2	7.7	7.7	7.5	7.5	7.4	7.4	7.6	7.5	7.9	7.5	8.1	7.8	8.6	8.5	8.9	8.9	8.9
Georgia	9.9	8.7	8.8	8.3	7.8	8.5	7.4	8.3	7.1	7.9	7.3	7.6	7.4	7.4	7.4	7.4	8.1	7.7	8.6	8.1	8.8	8.6	8.9	8.7	8.7
Florida	9.3	7.2	8.7	8.5	7.8	7.8	7.4	7.4	7.1	7.8	7.1	7.0	7.2	7.2	7.5	7.1	8.3	7.2	8.6	7.5	9.7	7.7	9.4	7.8	7.8
Ohio	11.9	13.3	11.0	13.5	11.6	13.6	11.8	13.4	11.7	12.3	11.1	11.4	10.9	11.5	11.6	11.5	11.7	11.7	12.0	12.2	12.2	11.7	11.7	12.4	12.4
Indiana	12.4	14.2	12.0	14.3	12.5	14.5	12.4	14.3	12.1	12.8	11.3	12.0	11.5	12.0	12.4	12.0	12.9	12.1	13.0	12.5	13.7	12.9	12.9	13.2	13.2
Illinois	13.0	13.8	11.8	13.8	12.3	14.1	12.4	14.1	12.9	12.8	12.5	12.2	11.9	12.1	12.4	11.9	12.9	12.1	13.4	12.4	13.7	12.9	12.8	12.8	12.8
Michigan	8.3	11.9	8.8	12.3	8.9	12.8	8.8	12.8	9.0	11.9	9.1	11.1	9.4	10.8	9.8	11.1	9.9	11.3	10.1	11.1	11.1	10.7	11.5	10.8	10.8
Wisconsin	9.7	12.8	9.4	12.9	9.2	13.5	9.6	13.4	9.6	12.3	9.9	12.2	10.1	11.9	11.0	11.4	11.9	11.7	12.7	12.0	12.6	11.8	12.4	12.1	12.1
Minnesota	12.8	15.1	11.9	15.4	11.6	15.5	11.6	15.2	11.9	13.8	11.8	13.7	11.4	13.1	12.5	12.7	13.2	12.7	13.6	13.3	14.6	13.5	13.9	13.9	13.9
Iowa	12.9	14.8	12.1	15.1	12.0	15.6	11.9	15.3	12.0	13.6	11.6	13.1	11.5	12.9	12.2	12.6	12.8	12.5	13.5	13.1	13.9	13.7	12.9	13.7	13.8
Missouri	11.5	11.8	10.3	12.0	10.5	12.2	10.8	12.2	11.0	10.8	10.6	10.5	10.4	10.2	10.5	10.5	10.6	11.0	10.6	11.3	11.0	11.3	10.8	11.2	11.2
North Dakota	9.2	12.4	8.4	11.9	8.5	12.2	9.0	12.5	9.6	11.9	9.6	11.4	8.7	10.9	9.3	10.8	9.9	11.3	11.5	12.0	12.5	12.0	11.6	11.7	11.7
South Dakota	12.8	14.8	11.7	14.6	11.8	15.1	11.7	15.0	11.9	13.7	11.8	12.8	12.0	12.5	12.6	11.9	12.9	12.4	13.0	13.2	14.0	13.8	13.8	14.0	14.0
Nebraska	12.3	13.8	11.3	14.0	11.3	14.7	11.7	14.6	11.5	12.8	11.0	12.4	11.0	12.2	11.6	11.6	12.1	12.1	12.6	12.4	12.8	13.1	12.0	13.2	13.2
Kansas	10.9	12.2	9.9	12.4	9.8	12.8	10.1	12.7	10.3	11.7	10.1	11.3	10.3	11.1	10.5	10.8	10.9	10.9	10.4	11.1	10.8	11.5	10.6	11.6	11.6
Kentucky	11.2	10.7	9.6	10.4	9.6	10.5	9.9	10.3	9.6	9.4	9.0	9.0	9.2	9.0	9.8	9.1	10.1	9.4	9.7	10.3	10.2	10.8	10.9	10.5	10.5
Tennessee	10.9	10.1	9.5	9.7	9.1	9.8	9.5	9.7	9.6	8.8	9.4	8.2	9.4	8.1	9.8	8.4	10.1	8.9	9.8	9.7	10.3	10.5	10.5	9.9	9.9
Alabama	10.4	8.9	9.0	8.4	8.1	8.3	8.3	8.3	8.5	7.6	8.7	7.3	8.5	7.2	8.8	7.4	9.0	7.7	9.3	8.1	9.7	8.6	9.3	8.3	8.3
Mississippi	10.5	8.6	9.1	8.3	8.2	8.3	8.1	8.0	8.2	7.4	8.6	7.4	8.4	7.3	8.7	7.6	9.0	8.0	9.4	8.6	9.5	9.0	9.7	8.7	8.7
Louisiana	7.9	8.5	8.0	8.3	7.6	8.3	7.2	8.1	7.7	7.7	7.5	7.2	7.0	7.4	7.1	7.8	7.7	8.3	7.7	8.8	8.8	8.8	8.9	8.7	8.7
Texas	8.0	8.6	7.3	8.6	7.1	8.6	7.4	8.7	7.5	8.2	7.5	8.1	7.5	8.2	8.1	8.7	7.9	9.3	8.2	9.4	8.5	9.2	8.5	9.0	9.0
Oklahoma	9.4	11.0	8.8	11.1	8.8	11.4	8.9	11.6	8.9	10.4	8.7	10.1	9.1	10.0	9.8	10.3	9.7	11.1	9.5	11.2	9.2	11.1	9.3	10.9	10.9
Arkansas	10.1	8.3	8.9	8.1	8.0	8.1	7.8	7.7	7.9	7.4	7.8	7.2	7.4	6.9	7.3	7.4	7.3	7.9	7.5	8.6	7.5	8.8	7.7	8.6	8.6
Far Western Division	8.5	8.9	8.0	9.2	8.2	9.5	8.4	9.6	8.8	9.1	8.7	8.7	8.2	8.8	8.4	9.0	8.9	9.3	9.0	9.2	9.3	9.1	8.7	8.9	8.9
United States	11.2	12.0	10.3	11.9	10.1	12.1	10.2	12.0	10.3	13.9	10.0	10.5	9.9	10.4	10.4	10.4	10.8	10.6	11.0	11.0	11.5	11.4	11.3	11.5	11.5

POP CORN.

TABLE 271.—Pop corn: Farm price, cents per bushel, 15th of month, 1912-1918.

Date.	1918	1917	1916	1915	1914	1913	1912
Jan. 15.....	301.9	198.0	169.3	164.7	172.3	147.0
Feb. 15.....	325.0	219.0	163.6	177.7	173.1	153.5
Nov. 15.....	593.0	267.5	181.7	140.3	159.0	169.3	141.0
Dec. 15.....	556.0	299.4	192.0	156.2	160.5	165.9	157.0

WHEAT.

WHERE THE WHEAT IS HELD.

The wheat crop of the United States is harvested within a comparatively short period, but is consumed or disposed of, more or less gradually throughout the year. There is, therefore, a large surplus above immediate needs soon after harvest, which is drawn upon as the year advances. It is of some interest to know in whose possession the surplus stocks are normally held from month to month; that is, what proportion is held by producers and what by dealers, and, of that held by dealers, what portion is "visible" and what portion is "invisible." The following tabulation is based upon the averages for the five years preceding the outbreak of the war, viz, 1909-10 to 1913-14. The beginning of the wheat crop season in the United States is generally regarded as July 1. For the purpose of simplicity it is assumed that the season's crop is in the farmers' hands on that date. Even though the entire crop is not harvested by that date, the crop is potentially in the farmers' possession, except the small portion which is marketed before July 1. The figures given in the table as stocks on farms refer to marketable wheat; that is, they do not include that held back on farms (mostly) for seed, which amounts for the period considered to about 75 million bushels, of which about 50 millions were for winter seeding and 25 for spring.

TABLE 272.—Estimated stocks of marketable wheat on farms (seed wheat excluded) and in dealers' hands on the first of each month, averages for the five-year period 1909-10 to 1913-14.

[Quantities in millions of bushels.]

Date.	On farms.	Com-mercial "visi-ble."	Com-mercial "invisi-ble."	Total.	Percentage of total each month—		
					On farms.	"Visi-ble."	"Invisi-ble."
July 1, old crop.....	30	23	26	681	38	29	33
July 1, new crop.....	602		88	4	8
Aug. 1.....	557	29	48	634	88	4	8
Sept. 1.....	472	36	72	580	82	6	12
Oct. 1.....	378	45	103	526	72	8	20
Nov. 1.....	294	54	124	472	62	12	26
Dec. 1.....	237	61	122	420	56	14	30
Jan. 1.....	190	62	117	369	51	17	32
Feb. 1.....	153	59	107	319	48	19	33
Mar. 1.....	124	56	91	271	46	21	33
Apr. 1.....	99	51	73	223	44	23	33
May 1.....	79	42	54	175	45	24	31
June 1.....	55	32	39	126	44	25	31
July 1.....	30	23	26	79	38	29	33

It will be observed that supplies on farms decrease steadily as the season advances; the visible supply increases until it reaches its maximum about January 1, and then declines; the "invisible" supply, which represents the wheat held by interior country dealers, reaches its maximum about November 1, or two months earlier than the "visible." The reduction in total supply each month is due to the allowance made for domestic consumption (about 41.4 million bushels per month) and exports, which averaged, in round millions of bushels, July, 6; August, 12; September, 13; October, 13; November, 11; December, 10; January, 8; February, 6; March, 6; April, 7; May, 7; and June, 6.

MONTHLY MARKETINGS.

TABLE 273.—Wheat: Monthly marketings by farmers, 1913-1918.

Month.	Estimated amount sold monthly by farmers of United States (millions of bushels).					Per cent of year's sales.				
	1917-18	1916-17	1915-16	1914-15	1913-14	1917-18	1916-17	1915-16	1914-15	1913-14
July.....	41	83	60	141	108	7.4	13.3	7.1	17.5	16.3
August.....	69	111	94	106	88	12.4	17.9	11.0	13.2	13.4
September.....	108	104	122	125	94	19.3	16.8	14.4	15.5	14.3
October.....	101	87	123	100	85	18.0	14.1	14.5	12.5	12.8
November.....	77	60	105	83	64	13.7	9.7	12.4	10.3	9.7
December.....	43	35	94	60	50	7.6	5.6	11.0	7.5	7.6
January.....	26	45	58	41	44	4.7	7.2	6.8	5.1	6.7
February.....	22	20	58	46	32	3.9	3.3	6.8	5.7	4.8
March.....	21	24	32	26	28	3.7	3.9	3.8	3.3	4.2
April.....	23	19	33	37	19	4.1	3.1	3.9	4.6	2.9
May.....	17	19	40	22	23	3.1	3.0	4.7	2.7	3.5
June.....	12	13	31	17	25	2.1	2.1	3.6	2.1	3.8
Season.....	560	620	851	804	660	100.0	100.0	100.0	100.0	100.0

GOVERNMENT PRICES.

TABLE 274.—Revised wheat prices.

Wheat prices established by presidential proclamation of February 21, 1918, and the prices established July 1, 1918, due to new freight rates, are shown below for important terminals:

Terminal.	New price, July 1.	Old price.	Increase.
New York.....	\$2.39½	\$2.28	\$0.11½
Philadelphia.....	2.39	2.27	.12
Baltimore.....	2.38½	2.27	.11½
Newport News.....	2.38½	2.27	.11½
Chicago.....	2.26	2.20	.06
New Orleans.....	2.28	2.20	.08
Galveston.....	2.28	2.20	.08
St. Louis.....	2.24	2.18	.06
Duluth.....	2.22½	2.17	.05½
Minneapolis.....	2.21½	2.17	.04½
Kansas City.....	2.18	2.15	.03
Omaha.....	2.18	2.15	.03
San Francisco.....	2.20	2.10	.10
Portland.....	2.20	2.05	.15
Seattle.....	2.20	2.05	.15

The new prices are those at which the Grain Corporation is prepared to buy wheat at the above markets, for No. 1 northern spring, No. 1 hard winter, No. 1 red winter, No. 1 durum, No. 1 hard white, in store in some public elevators approved for storage.

TABLE 275.—New wheat prices, July 1, 1918.

Kind.										
	Chicago.	Kansas City, Omaha.	St. Louis.	New Orleans, Galveston.	Minneapolis.	Duluth.	Baltimore, Newport News.	Philadelphia.	New York.	Tacoma, Seattle, Portland, Astoria, Los Angeles, San Francisco.
Northern spring, hard winter, red winter, durum, hard white:										
No. 1.....	Dolls. 2.26	Dolls. 2.18	Dolls. 2.24	Dolls. 2.28	Dolls. 2.21½	Dolls. 2.22½	Dolls. 2.38½	Dolls. 2.39	Dolls. 2.39½	Dolls. 2.20
No. 2.....	2.23	2.15	2.21	2.25	2.18½	2.19½	2.35½	2.36	2.36½	2.17
No. 3.....	2.19	2.11	2.17	2.21	2.14½	2.15½	2.31½	2.32	2.32½	2.14
Dark hard, dark northern spring, amber durum: No. 1.....	2.28	2.20	2.26	2.30	2.23½	2.24½	2.40½	2.41	2.41½	2.22
Yellow hard, soft white:										
No. 1.....	2.24	2.16	2.22	2.26	2.19½	2.20½	2.36½	2.37	2.37½	2.18
No. 2.....	2.21	2.13	2.19	2.23	2.16½	2.17½	2.33½	2.34	2.34½	2.15
No. 3.....	2.17	2.09	2.15	2.19	2.12½	2.13½	2.29½	2.28	2.30½	2.12
Red spring:										
No. 1.....	2.21	2.13	2.19	2.23	2.16½	2.17½	2.33½	2.34	2.34½	2.15
No. 2.....	2.18	2.10	2.16	2.20	2.13½	2.14½	2.32½	2.31	2.31½	2.12
No. 3.....	2.14	2.06	2.12	2.16	2.10½	2.11½	2.27½	2.27	2.27½	2.08
Red durum, red Walla:										
No. 1.....	2.19	2.11	2.17	2.21	2.14½	2.15½	2.31½	2.32	2.32½	2.13
No. 2.....	2.16	2.08	2.14	2.18	2.11½	2.12½	2.28½	2.29	2.29½	2.10
No. 3.....	2.12	2.04	2.10	2.14	2.07½	2.08½	2.24½	2.25	2.25½	2.06
White club:										
No. 1.....	2.22	2.14	2.20	2.24	2.17½	2.18½	2.34½	2.35	2.35½	2.16
No. 2.....	2.19	2.11	2.17	2.21	2.14½	2.15½	2.31½	2.32	2.32½	2.13
No. 3.....	2.15	2.07	2.13	2.17	2.10½	2.11½	2.27½	2.28	2.28½	2.09

PER CAPITA WHEAT CONSUMPTION IN VARIOUS COUNTRIES.

The consumption of wheat has been estimated for various countries, with results as given in the accompanying tabulation. The estimates are based upon the average production for 10 years, exports or imports of wheat (including wheat flour reduced to wheat equivalent), and an allowance made for quantities used for seed. Various conditions affect the accuracy of such estimates; data of exports or imports do not exactly coincide with data of crop production; the amount to be deducted for seed can be only roughly approximated, for while data of wheat acreage are regularly published the amount of seed used per acre in the different countries is not definitely ascertainable. The degree of accuracy varies considerably for the different countries; for instance, the estimates for such countries as England, France, and most countries of western Europe are probably within 3 per cent of the truth, whereas for Mexico and Egypt the estimate may be as much as 25 per cent wide of the mark. The figure given for the United States may be regarded as a minimum of probability and may be an underestimate of 2 or 4 per cent. Generally, however, it is believed that most of the figures are less than 10 per cent in error. With such qualifications the figures, owing to their wide variations, are of interest.

TABLE 276.—Per capita consumption of wheat in various countries, past decade (seed excluded and flour reduced to wheat equivalent).

	Bushels.		Bushels.		Bushels.
Canada.....	9.5	Uruguay.....	5.3	Russia.....	2.7
Belgium.....	8.3	Argentina.....	5.2	Servia.....	2.5
France.....	7.9	Bulgaria.....	5.0	Sweden.....	2.5
Spain.....	6.1	Austria-Hungary.....	4.3	Egypt.....	2.5
United Kingdom.....	6.0	Netherlands.....	4.2	Portugal.....	1.8
Switzerland.....	6.0	Roumania.....	4.0	British India.....	.8
Australia.....	5.5	Denmark.....	3.5	Mexico.....	.8
Italy.....	5.4	Chile.....	3.4	Japan.....	.5
United States.....	5.3	Germany.....	3.2		

WINTER WHEAT.

TABLE 277.—Winter wheat: Planted compared with harvested acreage.

Year.	Sown in fall of preceding year.		Under cultivation May 1.	Harvested.	
	Preliminary estimate.	Revised estimate.		Preliminary estimate.	Revised estimate.
	<i>Acres.</i>	<i>Acres.</i>	<i>Acres.</i>	<i>Acres.</i>	<i>Acres.</i>
1894.....	21,553,321	23,518,935
1895.....	24,224,358	22,609,322
1896.....	23,383,228	22,793,717
1897.....	23,986,470	24,764,551	21,562,035	22,925,623
1898.....	26,519,630	27,641,671	26,176,243	25,744,848
1899.....	29,953,639	25,903,592	25,357,592
1900.....	30,148,473	30,883,218	26,585,297	26,235,897
1901.....	30,282,564	28,267,457	30,239,701
1902.....	31,970,769	32,432,479	27,102,640	28,581,426
1903.....	34,070,583	33,106,689	32,510,510
1904.....	32,016,285	31,654,490	27,083,539	26,865,855
1905.....	31,155,313	29,723,421	29,864,018
1906.....	31,340,837	31,312,109	29,622,883	29,599,961
1907.....	31,664,574	28,131,736	28,132,000
1908.....	31,068,513	31,646,000	29,751,000	30,349,000
1909.....	29,884,000	129,301,000	129,171,000	127,151,000
1910.....	33,483,000	131,656,000	131,656,000	127,329,000
1911.....	34,485,000	32,648,000	31,367,000	29,162,000
1912.....	32,213,000	33,215,000	25,744,000	26,571,000
1913.....	32,387,000	33,618,000	30,867,000	31,699,000
1914.....	36,506,000	37,128,000	35,387,000	36,008,000
1915.....	41,263,000	42,881,000	40,169,000	40,453,000	41,308,000
1916.....	37,256,000	39,203,000	33,020,000	34,829,000	34,709,000
1917.....	40,090,000	40,534,000	27,653,000	27,430,000	27,257,000
1918.....	42,170,000	42,301,000	36,392,000	36,392,000
1919.....	49,261,000	48,933,000

1 Revised on census basis.

SPRING WHEAT.

TABLE 278.—Spring wheat: Percentage and yield of important varieties, 1914-1917.

The following table gives for the principal spring wheat States the estimated percentage which each important variety was of the total crop of the State for years indicated, also the estimated average yield per acre of such variety. The figures are of interest in showing the rapid popularity of Marquis in all the States named, and its greater yielding qualities than other spring varieties have, except durum. Durum appears to have a slight advantage over Marquis in yield per acre, and is gaining in popularity, although less rapidly than Marquis.

State and year.	Marquis.	Velvet chaff.	Blue stem.	Durum.	Fife.	Winter.	Other.
Minnesota:	<i>Per cent.</i>	<i>Per cent.</i>	<i>Per cent.</i>	<i>Per cent.</i>	<i>Per cent.</i>	<i>Per cent.</i>	<i>Per cent.</i>
1917.....	46.0	26.0	18.0	3.0	3.0	3.0	1.0
1916.....	30.7	28.9	30.8	2.2	3.8	3.3	.3
1915.....	1.9	98.1
1914.....	3.0	30.0	52.0	2.0	7.0	2.0	4.0
North Dakota:
1917.....	43.0	10.0	12.0	25.0	8.0	1.0	1.0
1916.....	38.3	12.2	14.1	18.5	15.9	.5	.5
1915.....	14.5	85.5
1914.....	5.0	11.0	45.0	13.0	21.0	4.0
South Dakota:
1917.....	43.0	20.0	11.0	20.0	3.0	3.0	.0
1916.....	22.5	28.4	22.8	12.0	2.6	11.5	.2
1915.....	22.7	77.3
1914.....	3.0	31.0	30.0	21.0	11.0	3.0	1.0
Montana:
1917.....	45.0	1.0	3.0	8.0	2.0	40.0	1.0
Minnesota:	<i>Bushels.</i>	<i>Bushels.</i>	<i>Bushels.</i>	<i>Bushels.</i>	<i>Bushels.</i>	<i>Bushels.</i>	<i>Bushels.</i>
1917.....	17.2	16.0	14.0	15.5	15.0	20.0	14.0
1916.....	11.0	7.4	5.5	8.5	6.9	14.0
1914.....	12.8	11.6	9.8	12.3	10.3	19.5	11.0
North Dakota:
1917.....	8.0	7.5	7.2	9.0	7.0	8.5	6.8
1916.....	6.0	5.2	3.8	7.3	4.5	11.9	5.0
1914.....	14.9	12.1	10.3	13.9	10.9	13.7	10.8
South Dakota:
1917.....	15.3	13.1	11.1	15.6	10.0	14.0
1916.....	7.9	6.2	5.0	8.2	5.0	18.5
1914.....	11.2	9.3	7.5	11.2	9.3	14.0	8.7
Montana, 1917.....	9.3	7.5	6.5	9.0	7.5	12.5	7.5

OATS.

TABLE 279.—Oats: Monthly marketings by farmers, 1913-1918.

Month.	Estimated amount sold monthly by farmers of United States (millions of bushels).					Per cent of year's sales.				
	1917-18	1916-17	1915-16	1914-15	1913-14	1917-18	1916-17	1915-16	1914-15	1913-14
July	24	31	23	35	29	4.7	8.3	5.1	10.4	9.9
August	82	87	53	64	57	16.4	23.3	11.8	18.7	18.3
September	67	51	59	55	44	13.5	13.5	13.0	16.3	13.2
October	56	40	57	40	33	11.1	10.7	12.7	11.7	10.5
November	38	30	48	27	22	7.7	8.0	10.6	7.9	6.8
December	39	21	47	23	24	7.8	5.7	10.5	6.9	7.6
January	42	28	33	26	18	8.3	7.5	7.4	7.6	5.6
February	40	20	36	19	21	8.0	5.3	8.0	5.6	6.7
March	35	20	23	15	19	7.1	5.2	5.0	4.4	5.9
April	33	14	21	13	10	6.5	3.8	4.6	3.7	3.3
May	20	17	28	10	18	4.0	4.4	6.3	3.1	5.8
June	24	16	22	13	20	4.9	4.3	5.0	3.7	6.4
Season	500	375	450	340	315	100.0	100.0	100.0	100.0	100.0

RICE.

TABLE 280.—Rice: Percentages of the several varieties planted in leading States, 1916-1918.

Investigations by the field agents and rice-crop specialist of the Bureau of Crop Estimates indicate the following percentages of the leading varieties of rice compared to the total acreage planted in each of the leading rice States:

State.	Honduras.			Japan.			Blue Rose.		
	1918	1917	1916	1918	1917	1916	1918	1917	1916
	<i>Per ct.</i>	<i>Per ct.</i>	<i>Per ct.</i>	<i>Per ct.</i>	<i>Per ct.</i>	<i>Per ct.</i>	<i>Per ct.</i>	<i>Per ct.</i>	<i>Per ct.</i>
Arkansas	27	49	52	2	2	8	28	37	30
California				96	94	93	1	3	6
Louisiana	12	20	30	5	4	18	57	47	51
Texas	7	16	25	4	11	21	60	51	54
United States	12	22	29	13	13	5	48	43	45

State.	Louisiana Pearl.			Early Prolific.			Other.		
	1918	1917	1916	1918	1917	1916	1918	1917	1916
Arkansas		2		15	2		128	28	1
California				2			1	33	1
Louisiana	12	25		10	4		44		1
Texas	14	14	1	11	5		64	23	
United States	10	16		10	3		7	3	1

¹ Carolina 27, Edith 1.
² Storm proof.

³ Italian.
⁴ Carolina 2, Edith 2.

⁵ Edith 2, Carolina 1, Storm proof 1.

CONSUMPTION OF CEREALS.

TABLE 281.—Consumption of specified cereals in selected countries; yearly average of 1902-1911.

BARLEY (INCLUDING MALT CONVERTED TO BARLEY).

Country.	Average yearly production, 1902-1911.	Average yearly net imports (+) or exports (-), calendar years, 1903-1912.	Average yearly total consumption, 1902-1911.	Mean yearly population, 1902-1911.	Average yearly consumption per capita, 1902-1911.
	<i>Bushels.</i>	<i>Bushels.</i>	<i>Bushels.</i>		<i>Bushels.</i>
Austria-Hungary	140,698,100	- 19,646,515	121,051,585	49,846,940	2.43
Belgium	4,522,200	+ 14,923,445	19,445,645	7,167,560	2.71
France	42,197,800	+ 4,833,776	47,031,576	39,298,974	1.20
Germany	144,776,000	+107,873,505	252,649,505	61,585,800	4.10
India (British)	No data.	No data.	No data.	305,740,192
Italy	8,531,600	+526,284	9,057,884	33,441,100	.27
Japan	80,927,400	+327,732	81,255,132	48,703,075	1.67
Netherlands	3,725,000	+ 10,525,789	14,250,789	5,699,030	2.50
United Kingdom	67,404,300	+ 49,777,334	117,181,634	43,567,991	2.69
United States	154,977,700	- 8,516,355	146,461,345	86,511,536	1.69

CORN (INCLUDING CORN MEAL CONVERTED TO CORN).

Austria-Hungary	178,206,000	+ 9,919,387	188,125,387	49,846,940	3.77
Belgium	No data.	+15,489,682	15,489,682	7,167,560	2.16
France	22,498,900	+14,331,060	36,829,960	39,298,974	1.94
Germany	No data.	+34,966,553	34,966,553	61,585,800	.57
India (British)	No data.	No data.	No data.	305,740,192
Italy	91,999,400	+ 8,076,924	100,076,324	33,441,100	2.99
Japan	3,293,636	No data.	3,293,636	49,576,649	.07
Netherlands	No data.	+17,394,010	17,394,010	5,699,030	3.05
United Kingdom	No data.	+85,060,797	85,060,797	43,567,991	1.95
United States	2,610,162,500	-66,350,065	2,543,812,435	86,511,536	29.40

OATS.

Austria-Hungary	226,441,600	+ 1,783,398	228,224,998	49,846,940	4.58
Belgium	41,767,200	+ 5,153,922	46,921,122	7,167,560	6.55
France	287,666,200	+18,278,510	305,944,710	39,298,974	7.79
Germany	543,084,100	+16,766,997	559,851,097	61,585,800	9.09
India (British)	No data.	No data.	No data.	305,740,192
Italy	26,194,900	+ 5,253,706	31,448,606	33,441,100	.94
Japan	No data.	No data.	No data.	48,703,075
Netherlands	18,931,800	+ 5,050,271	23,982,071	5,699,030	4.21
United Kingdom	185,497,700	+54,871,951	240,369,651	43,567,991	5.52
United States	926,202,100	- 8,388,532	917,813,568	86,511,536	10.61

RICE (MOSTLY CLEANED, AND INCLUDING RICE FLOUR, RICE MEAL, AND BROKEN RICE).

	<i>Pounds.</i>	<i>Pounds.</i>	<i>Pounds.</i>		<i>Pounds.</i>
Austria-Hungary	No data.	+ 199,620,672	199,620,672	49,846,940	4.00
Belgium	No data.	+ 83,479,728	83,479,728	7,167,560	11.65
France	4,307,788	+ 347,464,400	351,771,828	39,298,974	8.95
Germany	No data.	+ 474,747,264	474,747,264	61,585,800	7.71
India (British)	72,459,834,612	-4,317,112,596	68,142,722,016	305,740,192	222.88
Italy	695,551,200	- 121,158,863	574,392,337	33,441,100	17.18
Japan	4,743,609,000	+ 883,989,834	5,627,598,834	48,703,075	115.55
Netherlands	No data.	+ 264,373,207	264,373,207	5,699,030	46.39
United Kingdom	No data.	+ 599,577,437	599,577,437	43,567,991	13.76
United States	546,303,400	+ 176,058,271	722,361,671	86,511,536	8.35

RYE (INCLUDING RYE FLOUR CONVERTED TO RYE).

	<i>Bushels.</i>	<i>Bushels.</i>	<i>Bushels.</i>		<i>Bushels.</i>
Austria-Hungary	148,871,500	+ 1,132,777	150,004,277	49,846,940	3.00
Belgium	22,204,900	+ 2,585,205	24,790,105	7,167,560	3.46
France	51,817,900	+ 1,178,026	52,995,926	39,298,974	1.35
Germany	401,209,700	- 7,054,607	394,155,093	61,585,800	6.40
India (British)	No data.	No data.	No data.	305,740,192
Italy	4,496,800	+ 335,585	4,832,385	33,441,100	.14
Japan	No data.	No data.	No data.	48,703,075
Netherlands	14,860,900	+10,226,645	25,087,545	5,699,030	4.40
United Kingdom	1,920,400	+ 2,137,023	4,057,423	43,567,991	.09
United States	31,305,000	- 955,604	30,349,396	86,511,536	.35

1 Seven-year average, 1905-1911.

2 Four year average, 1908-1911, for production only.

TABLE 281.—Consumption of specified cereals in selected countries; yearly average of 1902-1911—Continued.

WHEAT (INCLUDING WHEAT FLOUR CONVERTED TO WHEAT).

Country.	Average yearly production, 1902-1911.	Average yearly net imports (+) or exports (-), calendar years, 1903-1912.	Average yearly total consumption, 1902-1911.	Mean yearly population, 1902-1911.	Average yearly consumption per capita, 1902-1911.
	<i>Bushels.</i>	<i>Bushels.</i>	<i>Bushels.</i>		<i>Bushels.</i>
Austria-Hungary.....	225,938,400	+ 3,211,466	229,149,866	49,846,940	4.60
Belgium.....	13,694,900	+ 45,111,355	58,806,255	7,167,560	8.20
France.....	327,510,900	+ 18,467,816	345,978,716	39,298,974	8.80
Germany.....	139,002,200	+ 69,235,002	208,237,202	61,585,800	3.38
India (British).....	305,331,300	- 44,278,524	261,052,776	305,740,192	0.85
Italy.....	169,121,900	+ 38,531,481	207,653,381	33,441,100	6.21
Japan.....	20,679,700	+ 4,824,385	25,504,085	48,703,075	.52
Netherlands.....	4,836,200	+ 19,607,231	24,443,431	5,699,030	4.29
United Kingdom.....	57,797,200	+210,819,395	268,616,595	43,567,991	6.17
United States.....	652,702,300	-107,141,601	545,560,699	86,511,536	6.31

NOTE.—Bushel: Barley, 48; oats, 32; corn and rye, 56; and wheat, 60 pounds.

POTATOES.

TABLE 282.—Potatoes: Percentage usually harvested each month, by States.

State.	April.	May.	June.	July.	August.	Septem-ber.	October.	Novem-ber.
Maine.....				1	9	55	34	1
New Hampshire.....				3	10	44	41	2
Vermont.....				2	8	44	45	1
Massachusetts.....				4	15	40	40	1
Rhode Island.....				10	25	40	24	1
Connecticut.....				3	10	45	40	2
New York.....				5	14	27	51	3
New Jersey.....			2	18	36	26	18	
Pennsylvania.....				8	18	39	32	3
Delaware.....			5	23	24	13	19	16
Maryland.....			4	17	21	23	25	10
Virginia.....		1	16	21	16	17	21	8
West Virginia.....			1	7	16	36	37	3
North Carolina.....		2	28	20	14	13	19	4
South Carolina.....	1	30	40	15	3	2	5	4
Georgia.....	1	16	25	18	10	9	16	4
Florida.....	38	33	7	1	1			2
Ohio.....				1	8	34	37	3
Indiana.....				1	11	27	43	1
Illinois.....				2	10	16	33	4
Michigan.....					4	10	22	61
Wisconsin.....					3	6	23	64
Minnesota.....					3	10	35	50
Iowa.....				1	8	13	33	42
Missouri.....		1	3	13	19	35	27	2
North Dakota.....				1	5	30	64	
South Dakota.....				1	5	14	35	2
Nebraska.....				1	6	10	37	45
Kansas.....				3	14	18	30	34
Kentucky.....				4	12	20	30	30
Tennessee.....		1	6	17	19	24	27	6
Alabama.....	1	30	35	20	7	3	3	1
Mississippi.....	2	14	37	28	8	4	5	2
Louisiana.....	2	46	38	10	1		3	
Texas.....	1	23	37	17	7	6	8	1
Oklahoma.....				1	22	34	20	2
Arkansas.....		5	30	21	10	15	13	6
Montana.....				3	9	31	56	1
Wyoming.....				2	8	30	56	4
Colorado.....				3	9	24	54	10
New Mexico.....				5	10	30	54	1
Arizona.....		5	26	10	3	6	50	
Utah.....				4	8	16	70	2
Nevada.....				1	6	21	69	3
Idaho.....				3	9	20	64	4
Washington.....				1	6	11	20	55
Oregon.....				1	6	9	19	53
California.....	2	4	9	12	9	18	39	6

[In Georgia 1 per cent harvested in March; in Florida 1 per cent in January, 4 in February, 2 in December; in Oregon and California 1 per cent in December.]

TABLE 283.—Potatoes: Percentage usually disposed of each month, by States.

State.	Jan.	Feb.	Mar.	Apr.	May.	June.	July.	Aug.	Sept.	Oct.	Nov.	Dec.
Maine.....	10	9	11	7	5	2	1	5	12	13	13	12
New Hampshire.....	8	6	7	6	5	1	2	5	13	20	14	13
Vermont.....	6	5	7	5	5	1	2	6	13	25	13	12
Massachusetts.....	5	5	5	5	3	2	2	11	18	23	12	9
Rhode Island.....	4	4	4	4	2	1	6	15	21	18	13	8
Connecticut.....	5	4	7	6	4	1	3	9	15	23	15	8
New York.....	5	4	5	6	5	2	4	7	16	27	13	6
New Jersey.....	3	2	3	2	1	2	15	30	17	12	9	4
Pennsylvania.....	4	3	6	6	3	1	5	9	19	25	13	6
Delaware.....	5	7	9	10	4	4	13	14	7	14	6	7
Maryland.....	5	5	5	6	3	2	10	15	15	17	10	7
Virginia.....	6	6	10	8	3	11	14	9	9	10	8	6
West Virginia.....	4	4	6	11	4	2	5	12	18	20	9	5
North Carolina.....	3	6	7	3	3	23	12	10	12	10	6	5
South Carolina.....	1	1	1	1	25	40	18	3	2	3	3	2
Georgia.....	2	2	2	2	13	20	18	12	10	10	6	3
Florida.....	2	2	11	36	31	10	2	1	1	1	1	2
Ohio.....	2	3	6	7	3	2	6	10	17	26	14	4
Indiana.....	5	4	6	6	3	3	7	10	16	25	9	6
Illinois.....	3	3	5	6	3	2	9	10	18	25	12	4
Michigan.....	4	4	7	10	6	2	3	6	10	26	16	6
Wisconsin.....	6	6	8	6	6	5	3	4	8	27	14	7
Minnesota.....	3	4	7	6	6	1	3	6	17	32	12	3
Iowa.....	2	2	3	5	4	1	7	12	20	37	5	2
Missouri.....	3	5	10	7	2	3	7	12	20	20	7	4
North Dakota.....	4	4	7	8	10	3	2	4	10	38	6	4
South Dakota.....	2	2	5	7	4	2	4	7	18	36	10	3
Nebraska.....	4	3	7	11	4	3	5	7	15	29	8	4
Kansas.....	2	2	5	3	1	3	10	15	20	26	10	3
Kentucky.....	5	4	12	5	1	2	6	12	15	21	11	6
Tennessee.....	5	7	9	5	2	7	12	14	14	13	8	4
Alabama.....	0	0	0	1	25	35	15	10	4	5	3	2
Mississippi.....	1	1	2	2	14	34	23	12	3	4	3	1
Louisiana.....	0	0	0	2	38	28	16	7	2	5	1	1
Texas.....	1	0	0	1	12	29	22	14	8	9	3	1
Oklahoma.....	1	1	1	0	1	15	30	25	12	7	5	2
Arkansas.....	2	5	5	2	4	20	18	11	14	10	6	3
Montana.....	3	3	7	10	4	2	2	6	11	31	16	5
Wyoming.....	3	3	5	10	7	3	2	4	12	26	20	5
Colorado.....	3	4	5	5	4	2	2	8	18	35	10	4
New Mexico.....	6	5	5	10	1	1	2	5	12	21	20	12
Arizona.....	3	2	2	4	5	24	12	3	6	18	14	7
Utah.....	3	2	5	7	5	2	4	6	10	34	16	6
Nevada.....	3	8	11	7	4	2	2	6	5	27	17	8
Idaho.....	2	4	4	7	5	2	3	8	13	23	20	9
Washington.....	4	5	8	7	4	2	5	8	12	26	13	6
Oregon.....	5	4	6	9	5	2	5	6	12	25	15	6
California.....	4	4	5	4	4	6	10	7	11	19	18	8
United States.....	4.4	4.4	6.7	6.7	4.9	4.0	5.8	8.3	13.7	23.5	11.8	5.8

HAY.

About 24 per cent of the entire hay crop is baled, according to estimates made by crop reporters of the Bureau of Crop Estimates. It is estimated that about 18,600,000 bales of tame or cultivated hay (26 per cent of the tame-hay crop) and 2,488,000 bales of wild hay (16.9 per cent of the wild-hay crop) will be baled from the 1918 crop.

TABLE 284.—Hay: Percentage of crop usually baled.

Maine.....	24	Ohio.....	27	Texas.....	61
New Hampshire.....	10	Indiana.....	28	Oklahoma.....	66
Vermont.....	13	Illinois.....	33	Arkansas.....	58
Massachusetts.....	6	Michigan.....	25	Montana.....	13
Rhode Island.....	10	Wisconsin.....	11	Wyoming.....	14
Connecticut.....	7	Minnesota.....	13	Colorado.....	24
New York.....	24	Iowa.....	15	New Mexico.....	55
New Jersey.....	20	Missouri.....	36	Arizona.....	59
Pennsylvania.....	21	North Dakota.....	5	Utah.....	18
Delaware.....	12	South Dakota.....	8	Nevada.....	13
Maryland.....	25	Nebraska.....	17	Idaho.....	17
Virginia.....	26	Kansas.....	33	Washington.....	36
West Virginia.....	25	Kentucky.....	45	Oregon.....	20
North Carolina.....	19	Tennessee.....	40	California.....	49
South Carolina.....	30	Alabama.....	50		
Georgia.....	44	Mississippi.....	43		
Florida.....	47	Louisiana.....	45		
				United States.....	24.4

FLAXSEED.

TABLE 285.—Flaxseed: Monthly marketings by farmers, 1913-1918.

Month.	Estimated amount sold monthly by farmers of United States (millions of bushels).					Per cent of year's sales.				
	1917-18	1916-17	1915-16	1914-15	1913-14	1917-18	1916-17	1915-16	1914-15	1913-14
July.....	0.1	0.2	0.2	0.2	0.4	1.8	1.2	1.5	1.5	2.6
August.....	.3	.3	.2	.2	.6	3.6	2.2	1.6	1.4	3.8
September.....	1.6	1.7	1.3	2.2	3.3	21.5	12.7	10.1	16.6	19.5
October.....	2.1	4.7	3.8	4.1	4.9	28.1	35.6	28.3	31.9	29.1
November.....	1.3	3.2	3.6	3.2	3.1	17.6	24.3	27.0	24.7	18.2
December.....	.6	1.5	1.6	1.2	1.9	7.6	11.4	11.9	9.3	10.9
January.....	.3	.6	.6	.5	.9	4.7	4.4	4.6	3.6	5.2
February.....	.3	.2	.7	.4	.5	4.0	1.7	5.1	3.2	2.9
March.....	.4	.3	.4	.4	.7	4.8	2.0	3.3	3.0	3.9
April.....	.1	.1	.2	.2	.2	1.8	.9	1.6	1.6	1.1
May.....	.1	.2	.2	.1	.2	1.6	1.6	1.6	1.2	1.0
June.....	.2	.3	.5	.3	.3	2.9	2.0	3.4	2.0	1.8
Season.....	7.4	13.3	13.3	13.0	17.0	100.0	100.0	100.0	100.0	100.0

TOBACCO DISTRICTS IN EACH STATE.

The tobacco specialist of the Bureau of Crop Estimates, J. P. Killebrew, has estimated, for those States which grow more than one type of tobacco, the approximate acreage in each type, or district, in 1918, as follows (figures in parentheses are percentages which the respective type or district represents of the total tobacco acreage of the State):

Virginia.—Sun-cured, 13,200 acres (7 per cent); Virginia Dark, 68,200 (36); Old Bright belt, 107,000 (56); all other, 1,600 (1).

North Carolina.—Old Bright belt, 135,000 (34); New Bright belt, 263,600 (66); all other, 1,400 (less than 1 per cent).

Ohio.—Miami Valley, 68,700 (59); Export, 6,000 (5); Burley, 40,000 (35); all other, 900 (1).

West Virginia.—Burley, 12,600 (93); Export, 600 (4); all other, 400 (3).

Indiana.—Stemming, 5,000 (31); Burley, 11,000 (67); all other, 800 (2).

Tennessee.—Burley, 6,000 (8); Paducah, 22,000 (28); Clarksville and Hopkinsville, 37,000 (48); One-sucker, 12,000 (15); all other, 800 (1).

Kentucky.—Burley, 210,700 (44); Paducah, 73,000 (16); Stemming, 86,400 (18); One-sucker, 38,000 (8); Clarksville and Hopkinsville, 63,000 (13); all other, 3,900 (1).

SEA-ISLAND AND EGYPTIAN COTTON ACREAGE.

The Bureau of Crop Estimates of the United States Department of Agriculture estimates that the area planted to sea-island and Egyptian cotton in 1918 is about 356,000 acres, of which 276,000 acres are sea-island and 80,000 acres Egyptian; this compared with 352,000 in 1917. There is a heavy decrease in the acreage in the older sea-island sections in Georgia and Florida, where the boll weevil is very active, and a corresponding increase in the Egyptian acreage in Arizona and California. The production is forecast (July 25) at 110,000 running bales, of which 65,000 bales are sea-island and 45,000 bales Egyptian, as against a total production of 106,000 running bales in 1917. Details by States follow:

TABLE 286.—Acreage and production of sea-island and Egyptian cotton, 1917 and 1918.

State.	Acreage in 1918.	Acreage in 1917.	Estimated production (running bales).	
			1918	1917
SEA ISLAND.				
Georgia.....	129,000	156,000	34,000	48,000
Florida.....	125,000	139,000	23,000	37,000
South Carolina.....	22,000	21,000	8,000	7,000
EGYPTIAN.				
Arizona.....	75,000	33,000	42,000	13,000
California.....	5,000	3,000	3,000	1,000
United States.....	356,000	352,000	110,000	106,000

BEANS.

TABLE 287.—Edible beans.—Acreage and production 1918 and 1917, and distribution by varieties 1918.

A special investigation by the field agents of the Bureau of Crop Estimates permits the following statement, involving some minor changes from previous estimates, on acreage and production, 1918 and 1917. The per cent of each variety is shown for 1918. Farm prices appear regularly, by States, in the "Monthly Crop Reporter."

State.	Acreage.		Total production.		Varieties—Per cent of acreage, 1918. ¹											
	1918.	1917.	1918.	1917.	Small white.	Large white. ²	White kidney. ³	Red kidney.	Yellow eye.	Cranberry. ³	Red Mexican.	Lima. ⁴	Pinto.	Bayo.	Pinks.	Miscellaneous.
			<i>Bushels.</i>	<i>Bushels.</i>												
Me.....	21,000	27,000	178,000	270,000	14.0	20.0	12.0	41.0								13.0
N. H.....	6,500	7,355	65,000	73,550	38	2	15	35								10
Vt.....	10,500	10,000	120,000	100,000	47	2	3	41								7
Mass.....	4,000	4,165	46,000	16,660	13	2	3	68		9.0	2.0					3
R. I.....	1,000	1,000	16,000	8,000	15	40	8	15								20
Conn.....	1,600	1,500	24,000	15,000	16	3	8	19								6
N. Y.....	200,000	250,000	1,660,000	1,875,000	42	16.0	14	19								14
N. J.....	2,200	2,000	18,300	20,000	56	1	1	8			18		2.0			9
Pa.....	5,500	5,000	63,000	50,000	66	2	1	8	2		10					5
Md.....	4,000	4,000	44,000	63,000	50			8			35				2.0	
Va.....	18,000	14,000	261,000	189,000												
W. Va.....	20,000	18,000	160,000	144,000	56			28			5					11
Ga.....	4,200	3,700	34,000	41,500	20			4			7					69
Ind.....	2,000	2,000	24,000	22,000	94			1			2					3
Mich.....	543,000	537,000	4,887,000	3,294,000	88	7		4			2					1
Wis.....	21,000	33,000	254,000	139,000	91			6								3
Minn.....	5,000	8,000	50,000	8,000	86			4			3					7
Iowa.....	5,000	5,000	25,000	42,000	95											5
Mo.....	10,000	12,000	75,000	120,000	90			1			2	3				4
Nebr.....	5,000	21,000	40,000	107,000	37	20		2.				38				3
Ky.....	25,000	18,000	200,000	144,000												
Tenn.....	6,000	10,000	24,000	60,000	44			20			8	3				25
Mont.....	16,500	8,000	189,600	88,000	13	80		2								5
Colo. ⁵	252,000	250,000	1,638,000	1,950,000	8			0								4
N. Mex.....	149,000	207,000	596,000	683,000	2							88	8			1
Ariz.....	18,000	19,000	72,000	152,000	2							3		95		
Idaho.....	43,000	32,000	860,000	416,000	75	14		3			1	7				
Wash.....	9,000	9,000	123,000	122,000	60	30				10.0						
Oreg.....	15,000	15,000	138,000	101,000	85			10								5
Calif.....	592,000	558,000	8,584,000	8,091,000	19	12				2	3	33		2	14	15
Other.....	35,000	35,000	350,000	315,000												
U. S.....	2,050,000	2,126,720	20,818,900	18,719,710	41.9	8.2	0.8	3.7	3.2	0.6	0.9	9.9	17.6	1.3	5.0	6.9

¹ Distribution by varieties for 1918 not reported for W. Va., Ga., Ind., Minn., Mo., Tenn., Colo., Ariz., and Idaho, hence distribution is shown for 1917.

² Including in New York and Pennsylvania the white marrow or marrowfat; in Montana an old Indian type, lately commercialized; in Idaho and Washington, the "Lady Washington" is the synonym of the "Large White" of California.

³ "Horticultural."

⁴ Including Henderson Bush 2.6 per cent in California.

⁵ 30,000 acres additional grown in Colorado, of garden varieties for seed.

⁶ Including Blackeye 9 per cent and Tepary 5 per cent.

METHOD OF GATHERING GRAIN CROPS.

Methods of gathering small grains differ somewhat in different sections of the United States. The great bulk of wheat, oats, barley, and rye is thrashed, but in some places some of the acreage is cut and used for feed without thrashing, or cut green and cured for hay. The following estimates are based upon reports of field agents of the Bureau of Crop Estimates, supplemented by reports of county crop reporters. *a*=percentage of State total matured and thrashed after harvest; *b*=matured and cut but not thrashed, i. e., used as feed in the straw; *c*=cut green and cured for hay; *d*=not cut (including pastured or hogged off, green manure, etc.).

TABLE 288.—Percentage of grain crops gathered by the four methods.

State.	Wheat.				Oats.				Barley.				Rye.			
	<i>a.</i>	<i>b.</i>	<i>c.</i>	<i>d.</i>	<i>a.</i>	<i>b.</i>	<i>c.</i>	<i>d.</i>	<i>a.</i>	<i>b.</i>	<i>c.</i>	<i>d.</i>	<i>a.</i>	<i>b.</i>	<i>c.</i>	<i>d.</i>
Me.					84.9	5.0	10.0	0.1								
N. H.					49.0	1.0	50.0	0								
Vt.					80.0	5.0	15.0	0					80.0	3.0	10.0	7.0
Mass.					15.0	10.0	74.0	1.0					50.0	13.0	30.0	7.0
R. I.																
Conn.					53.7	9.1	36.6	.6								
N. Y.	99.1	0.5	0.2	0.2	92.4	2.2	5.1	.3	99.6	0.1	0.3	0	87.9	1.4	3.2	7.5
N. J.	98.0	0	1.0	1.0	74.0	7.0	19.0	0					83.0	2.0	8.0	7.0
Pa.	99.1	.5	0	.4	94.5	1.5	3.5	.5	96.0	2.0	1.0	1.0	89.0	1.0	2.8	7.2
Del.	99.0	1.0	0	0	84.0	9.0	3.0	4.0					69.0	4.0	9.0	18.0
Md.	99.0	1.0	0	0	84.0	6.0	10.0	0	100.0	0	0	0	82.0	3.0	4.0	11.0
Va.	95.1	2.2	1.7	1.0	57.9	32.6	8.1	1.4	75.5	13.9	2.2	8.4	51.8	8.7	15.1	24.4
W. Va.	96.0	2.0	.5	1.5	67.0	16.0	11.0	6.0					60.0	3.0	7.0	30.0
N. C.	97.0	3.0	0	0	53.0	30.0	15.0	2.0					38.0	6.0	12.0	44.0
S. C.	96.0	2.0	1.0	1.0	39.0	57.0	3.0	1.0	78.0	0	6.0	16.0	39.0	0	10.0	51.0
Ga.	90.0	5.0	4.0	1.0	45.0	47.0	7.0	1.0					46.0	7.0	12.0	35.0
Fla.					10.0	65.0	15.0	10.0					0	0	10.0	90.0
Ohio.	100.0	0	0	0	97.0	2.0	1.0	0	98.0	0	1.0	1.0	82.0	1.0	2.0	15.0
Ind.	99.0	0	0	1.0	85.0	5.0	9.0	1.0	100.0	0	0	0	80.0	4.0	2.0	14.0
Ill.	98.0	1.1	.2	.7	89.6	8.9	1.1	.4	96.6	2.7	.6	.1	81.8	3.5	3.8	10.9
Mich.	99.3	.3	.1	.3	97.2	1.5	1.1	.2	99.1	.4	.2	.3	93.9	.5	1.6	4.0
Wis.	99.5	.5	0	0	94.1	3.2	2.3	.4	98.4	.6	.2	.8	95.9	.5	1.4	2.2
Minn.	99.5	.5	0	0	97.0	3.0	0	0	99.1	.3	.2	.3	100.0	0	0	0
Iowa.	98.0	2.0	0	0	95.0	5.0	0	0	97.0	3.0	0	0	70.0	5.0	2.0	23.0
Mo.	96.0	1.0	1.0	2.0	82.0	10.0	6.0	2.0	96.0	1.0	0	3.0	60.0	5.0	5.0	30.0
N. Dak.	100.0	0	0	0	98.0	1.0	1.0	0	99.0	0	0	1.0	99.0	0	0	1.0
S. Dak.	100.0	0	0	0	100.0	0	0	0	100.0	0	0	0	88.0	4.0	8.0	0
Nebr.	99.0	.8	0	.2	97.0	1.3	1.3	.4	99.0	.8	0	.2	90.0	0	1.0	9.0
Kans.	99.0	0	0	1.0	98.0	0	0	0	2.0	99.0	0	0	1.0	80.0	0	20.0
Ky.	95.0	0	0	5.0	40.0	51.0	7.0	2.0	84.0	6.0	0	10.0	20.0	10.0	3.0	67.0
Tenn.	95.0	1.0	1.5	2.5	50.0	25.0	23.0	2.0	53.2	4.1	10.1	32.6	33.0	1.0	6.0	60.0
Ala.	96.0	3.0	0	1.0	36.0	50.0	10.0	4.0					28.0	9.0	17.0	46.0
Miss.	90.0	4.0	2.0	4.0	28.0	64.0	6.0	2.0					10.0	0	0	90.0
La.					38.0	52.0	7.0	3.0								
Tex.	98.0	0	1.0	1.0	90.0	2.0	6.0	2.0								
Okla.	99.5	0	0	.5	89.8	7.2	1.5	1.5	85.0	1.8	.3	12.9	80.8	.2	.3	18.7
Ark.	89.0	4.0	5.0	2.0	35.0	43.0	21.0	1.0					21.0	7.0	27.0	45.0
Mont.	95.0	2.0	2.5	.5	89.0	4.7	6.0	.3	92.0	2.0	5.5	.5	83.0	3.0	12.0	2.0
Wyo.	91.0	4.0	4.0	1.0	89.0	6.0	3.0	2.0	88.0	6.0	4.0	2.0	64.0	16.0	16.0	4.0
Colo.	94.1	1.6	3.6	.7	85.0	5.0	8.0	2.0	91.0	2.2	4.5	2.3	67.0	8.0	21.0	4.0
N. Mex.	93.0	3.0	2.0	2.0	83.0	6.0	10.0	1.0	82.0	6.0	11.0	1.0	70.0	12.0	10.0	8.0
Ariz.	91.0	4.0	4.0	1.0	46.0	6.0	47.0	0	10.0	83.0	4.0	12.0	1.0			
Utah.	97.1	1.2	1.0	.7	97.6	.7	1.6	.1	98.4	.9	.5	.2	83.4	5.3	9.2	2.1
Nev.	97.0	2.0	1.0	0	96.0	1.0	3.0	0	99.0	3.0	.5	0				
Idaho.	94.0	2.0	4.0	0	75.0	5.0	5.0	.5	89.0	8.0	3.0	0	70.0	0	30.0	0
Wash.	84.0	4.0	11.0	1.0	75.0	6.0	19.0	0	85.0	3.0	7.0	5.0	48.0	13.0	24.0	15.0
Oreg.	87.3	2.3	9.5	.9	74.3	2.1	22.5	1.1	94.1	1.4	2.2	2.3	54.2	8.8	34.2	2.8
Calif.	66.0	4.0	28.0	2.0	38.0	7.0	55.0	0	64.0	3.0	29.0	4.0	44.0	1.0	28.0	27.0
U. S.	97.5	.7	1.1	.7	88.1	7.8	3.5	.6	91.9	1.3	5.4	1.4	86.6	1.8	3.5	8.1

EARLY APPLE PRODUCTION.

The important counties in the United States producing early varieties of apples in considerable quantity for commercial channels and their leading varieties are: Sonoma County, Cal.—Gravenstein; Union and Johnson Counties, Ill.—Benoni, Transparent, Duchess, and Sops of Wine; Monmouth County, N. J.—English Codlin, Gravenstein, Twenty Ounce, Red Astrachan, Duchess, and Wealthy; Burlington County, N. J.—Starr, Williams Early Red, Yellow Transparent, and Wealthy; Kent and Sussex Counties, Del.—Yellow Transparent, Williams Early Red, and Nero; Washington County, Md., Berkeley County, W. Va., and Frederick County, Va.—Yellow Transparent; Niagara County, N. Y.—Duchess and Wealthy.

Early apples in commercial quantities are also produced in the Ozarks, where Maiden Blush and Yellow Transparent are favorites; also in the Missouri River region, southern Ohio and Indiana, Hudson Valley, Central Lake district of New York, and parts of Tennessee. Transparent leads in southern regions and Duchess in the more northern. Duchess and Wealthy are not considered as being in the early class where they go on the market late, as in Michigan, Wisconsin, etc.

PEACH CROP CENTRALIZED.

The peach crop is a highly centralized crop in many States. For instance, Ottawa County, Ohio, normally produces 90 per cent of the commercial peaches of that State. Washington County, Md., produces about 60 per cent of the Maryland crop. Hampshire, Morgan, and Mineral Counties produce 89 per cent of the State crop of West Virginia. Houston and Macon Counties, Ga., produce 60 per cent of the State crop. Franklin County, Pa., produces 45 per cent of the State crop. Moore and Montgomery Counties, N. C., produce 75 per cent of the North Carolina crop. Niagara, Orleans, Monroe, and Wayne Counties produce 85 per cent of the New York crop. Berrien and Van Buren Counties, Mich., produce 68 per cent of the Michigan crop. Crawford, Johnson, Polk, Sebastian, Franklin, Yell, and Logan Counties produce 46 per cent of the peaches of Arkansas. Cherokee, Wood, Smith, Hopkins, and Franklin Counties produce 48 per cent of the Texas crop.

YEARLY VARIATION IN CROP PRODUCTION.

The variation in total production of a crop in one year as compared with another is due to a change of acreage or to a change of yield per acre. Of these two factors the yield per acre is the more important in causing the yearly fluctuations in production in the United States. This fact is shown graphically in the accompanying series of charts, which show the variation of production, yield per acre, and acreage, in the United States, since 1909. The lines representing total production and yield per acre run in nearly the same direction. The greatest influence of change of acreage was in 1916 and 1917, in which years the war caused abnormal acreage changes; but even in these years yield per acre was the dominant influence.

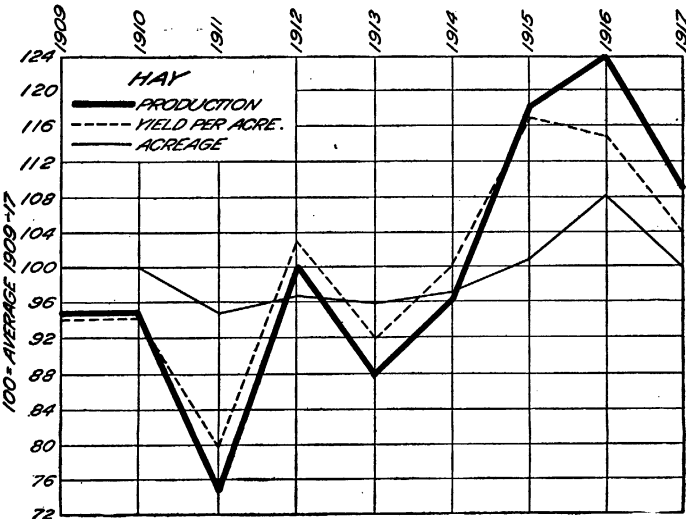
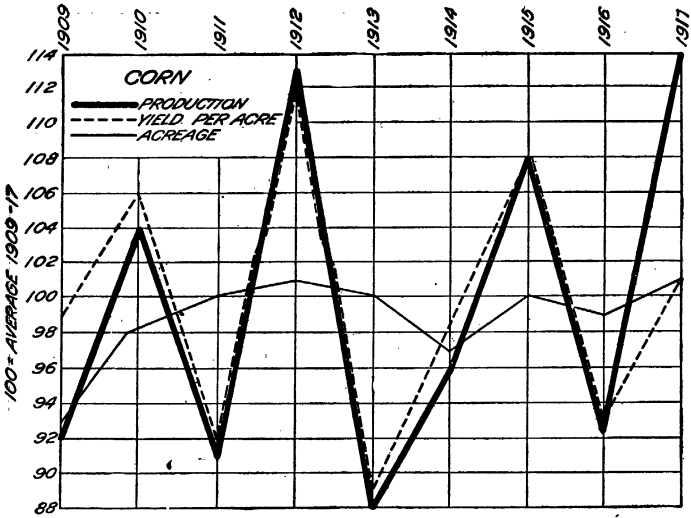

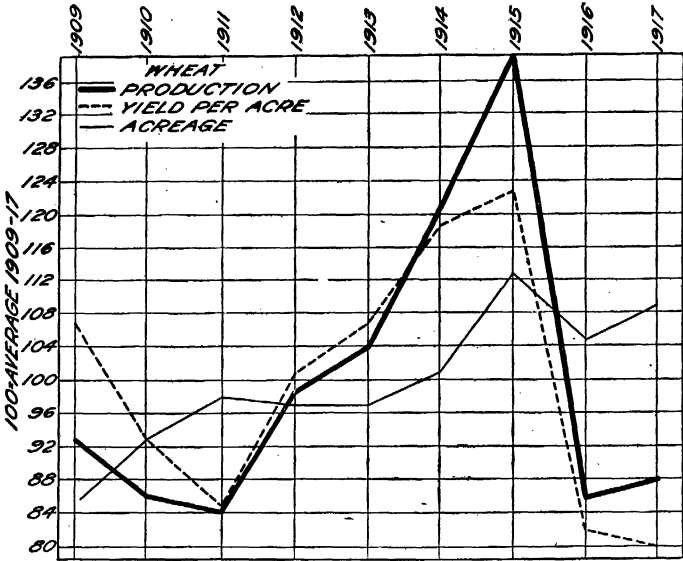
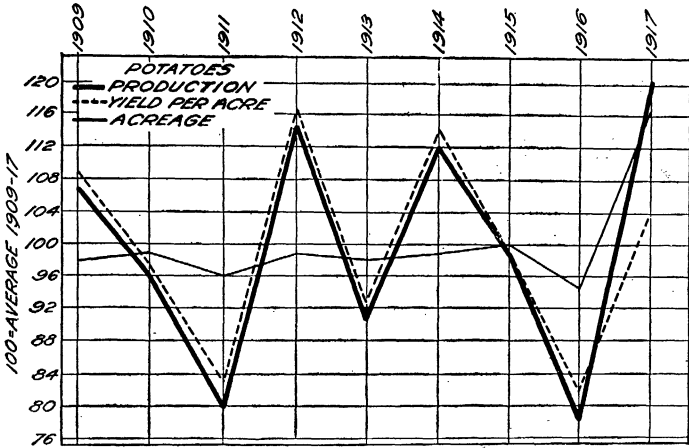

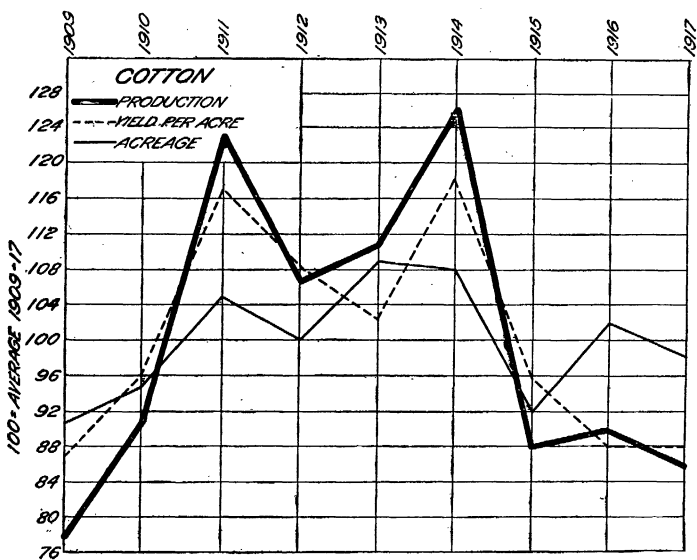
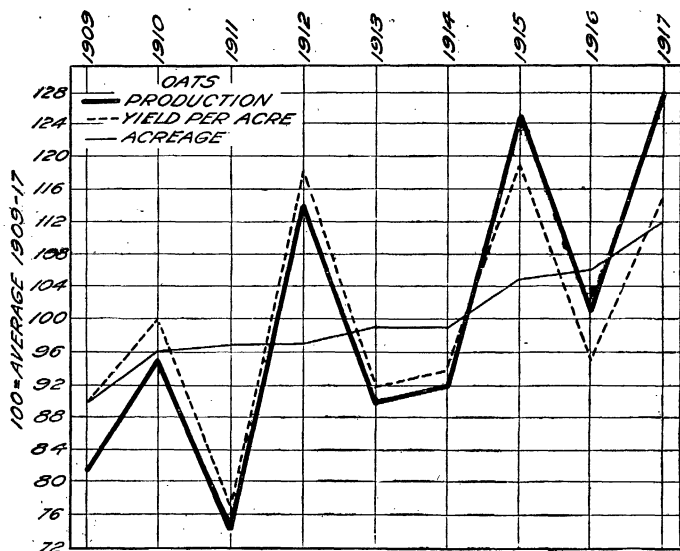

PRICES OF ARTICLES BOUGHT BY FARMERS.

TABLE 292.—Prices of articles bought by farmers, 1909–1918, and amount purchasable with an acre of crop production.

Item.	1918	1917	1914	1909	1918 per cent of—			Amount purchasable with average value of 1 acre of crop production.		
					1917	1914	1909	1918	1914	1909
Axes.....each	\$1.85	\$1.40	\$0.96	\$0.89	132	193	208	21	18	19
Axle grease.....box	.169	.137	.119	.118	123	142	143	227	145	141
Barb wire.....100 lbs	6.14	5.00	3.08	2.98	123	199	206	6.3	5.6	5.6
Barrels, for apples.....each	.51	.37	.25	138	204	75	62
Baskets, ½ bushel.....do	.55	.50	.38	.35	110	145	157	70	46	48
Bone meal.....ton	55.30	48.00	31.90	115	17369	.54
Brooms.....each	1.05	.76	.38	.34	138	276	309	37	46	49
Buggies.....do	110.00	89.00	70.10	64.90	124	157	169	.35	.25	.26
Buggy whips.....do	.74	.57	.426	.404	130	174	183	52	41	41
Calico.....yard	.225	.128	.063	.06	176	357	375	171	275	277
Churns.....each	4.05	3.50	2.30	2.19	116	176	185	9.5	7.5	7.6
Coal.....ton	8.30	7.50	5.80	5.50	111	143	151	4.6	3	3
Coal oil.....gall	.190	.159	.139	.157	119	137	121	202	125	106
Coffee.....lb	.285	.265	.245	.211	108	116	135	135	71	79
Corn knives.....each	.57	.43	.29	.27	133	197	211	67	60	62
Cream separators.....do	89.00	77.00	59.30	63.10	116	150	141	.43	.29	.26
Dinner plates.....one-half doz	1.26	.88	.57	.55	143	221	229	30	30	30
Dish pans, tin.....each	.85	.60	.34	.32	142	250	266	45	51	52
Dung forks.....do	1.32	1.03	.76	.70	128	174	189	29	23	24
Fertilizer, commercial.....ton	39.50	31.90	23.20	22.15	124	170	178	.97	.75	.75
Flour.....bbl	12.30	12.05	6.40	6.30	102	192	195	3.1	2.7	2.6
Fruit jars.....doz	1.10	.92	.74	.73	120	149	151	35	23	23
Gasoline.....gall	.291	.261	.179	.202	111	163	144	132	97	82
Halters.....each	1.75	1.36	.95	.85	129	184	206	22	18	20
Harness.....do	25.30	19.00	15.25	13.50	133	166	187	1.5	1.1	1.2
Harrows.....do	26.20	19.30	11.60	11.20	136	226	234	1.5	1.5	1.5
Hatchets.....do	1.14	.80	.62	.59	142	184	193	34	28	28
Hats, felt.....do	3.45	2.65	2.03	1.94	130	170	178	11	8.5	8.6
Hoes.....do	.80	.61	.45	.41	131	178	195	48	38	41
Horse blankets.....do	4.70	3.50	2.40	2.25	134	196	209	8.2	7.2	7.4
Jumpers.....do	2.38	1.52	.83	.77	157	287	309	16	21	22
Kitchen chairs.....do	1.55	1.12	.80	.72	138	194	215	25	22	23
Lamps.....do	.92	.72	.52	.50	128	177	184	42	30	30
Lanterns.....do	1.30	1.00	.80	.77	130	162	169	30	22	22
Lard.....lb	.328	.286	.141	.132	115	233	248	117	123	126
Lime.....bbl	2.41	1.78	1.36	1.29	135	177	187	16	13	13
Linseed oil.....gall	2.17	1.48	.82	.79	147	265	275	18	21	21
Lumber, 1-inch.....100 feet	3.65	2.85	2.10	1.95	128	174	187	11	8.2	8.5
Manure spreaders.....each	178.00	145.00	106.70	111.60	123	167	159	.22	.16	.15
Men's suits.....do	27.50	20.00	14.00	13.15	138	196	209	1.4	1.2	1.5
Milk cans, 10-gallon.....do	5.70	4.30	2.45	2.40	133	233	238	6.7	7.1	6.9
Milk pails.....do	.92	.67	.45	.43	137	204	214	42	38	39
Mowers.....do	80.00	63.00	46.50	44.30	127	172	181	.48	.37	.38
Muslin.....yd	.288	.180	.093	.09	160	310	320	133	186	185
Nails.....100 lbs	6.35	5.25	3.40	3.34	121	187	190	6.1	5.1	5
Overalls.....pair	2.42	1.54	.89	.82	157	272	295	16	19	20
Padlocks.....each	.49	.37	.275	.27	132	178	181	78	63	62
Paint brushes.....do	1.06	.84	.54	.49	126	196	216	36	32	34
Paint, mixed.....gall	3.55	2.80	1.74	1.62	127	204	219	11	9.9	10
Paris green.....lb	.67	.55	.30	.29	122	223	231	57	58	57
Picks.....each	1.28	.99	.72	.71	129	178	180	30	24	23
Pincers.....do	.97	.76	.51	.49	128	190	198	40	34	34
Pitchforks.....do	1.22	.94	.66	.62	130	185	197	31	26	27
Plows.....do	23.00	18.00	12.10	11.50	128	190	200	1.7	1.4	1.4
Portland cement.....100 lbs	1.10	.95	.69	.70	116	159	157	35	25	24
Rain coats.....each	8.50	6.40	4.40	4.25	133	193	200	4.5	3.9	3.9
Rope, hemp.....lb	.370	.287	.149	.135	129	248	274	104	116	123
Rubber boots.....pair	5.30	4.50	3.75	3.55	118	141	149	7.2	4.6	4.7
Sacks, grain.....each	.46	.30	.163	.15	153	282	307	84	106	111
Saddles.....do	37.80	30.50	20.35	17.45	124	186	217	1	.85	.95

TABLE 292.—Prices of articles bought by farmers, 1909–1918, and amount purchasable with an acre of crop production—Continued.

Item.	1918	1917	1914	1909	1918 per cent of—			Amount purchasable with average value of 1 acre of crop production.		
					1917	1914	1909	1918	1914	1909
					Salt, for stock.....bbl.	\$2.75	\$2.18	\$1.65	\$1.50	126
Saws, buck.....each	1.58	1.18	.92	.89	134	172	178	24	19	19
Screw hooks.....box	.92	.66	.373	.364	139	247	253	42	46	46
Scythes.....each	1.70	1.30	1.06	1.02	131	160	167	23	16	16
Sheeting.....yard	.50	.32	.18	.17	156	278	294	77	96	98
Shingles.....1,000	5.50	4.70	3.70	3.50	117	149	157	7	4.7	4.8
Shirts, flannel.....each	3.25	2.25	1.41	1.34	144	230	243	12	12	12
Shoes.....pair	4.05	3.35	2.30	2.00	121	176	202	9.5	7.5	8.3
Shotguns.....each	25.10	18.50	12.85	12.45	136	195	202	1.5	1.3	1.3
Shovels.....do	1.50	1.15	.78	.74	130	192	203	26	22	22
Starch.....lb	.110	.095	.07	.07	116	157	157	349	247	241
Staples.....100 lbs	6.80	5.70	3.75	3.69	119	181	184	5.6	4.6	4.5
Steel wire.....do	6.80	5.60	3.55	3.43	121	192	198	5.6	4.9	4.8
Stoves.....each	50.00	37.00	24.00	22.50	135	208	222	.77	.72	.74
Sugar.....lb	.110	.097	.069	.058	113	159	190	349	251	287
Sulphur.....do	.130	.100	.08	.075	130	162	173	296	216	222
Tedders.....each	71.50	52.00	39.50	39.00	138	181	183	.54	.44	.43
Tin pails.....each	.60	.41	.27	.25	146	222	240	64	64	67
Tobacco, plug.....lb	.77	.56	.45	.45	138	171	171	50	38	37
Twine, binder.....do	.28	.22	.112	.103	127	250	272	137	155	162
Wagons, double.....each	125.00	97.00	73.25	66.00	129	171	189	.31	.24	.25
Wheelbarrows.....do	4.90	4.00	2.97	2.80	122	165	175	7.8	5.8	5.9
Wire fence.....rod	.61	.49	.317	.311	124	192	196	63	55	54
Wooden buckets.....each	.90	.62	.35	.31	145	257	290	43	49	54
Wooden washtubs.....do	1.65	1.20	.83	.77	138	199	214	23	21	22

FARM LABOR.

HOW FARM LABOR IS HIRED.

The following tabulation shows, by States, what percentage of the total hired farm labor of each State is hired by the month with board included; by the month without board; by the day, except extra harvest labor, with board and without board; by the day, extra harvest labor, with and without board. In the last two columns is shown what percentage of all hired labor of the State is hired with board and without board respectively. The figures are estimates based upon reports from crop reporters of the Bureau of Crop Estimates.

TABLE 293.—Percentages of male farm labor by classes and States.

State and division.	By month—		By day, except extra harvest—		Extra harvest labor—		Percentage of all labor hired—	
	With board.	Without board.	With board.	Without board.	With board.	Without board.	With board.	Without board.
	Per ct.	Per ct.	Per ct.	Per ct.	Per ct.	Per ct.	Per ct.	Per ct.
Maine.....	31	14	25	12	10	8	66	34
New Hampshire.....	35	12	18	19	9	7	62	38
Vermont.....	52	14	13	6	9	6	74	26
Massachusetts.....	47	10	6	20	7	10	60	40
Rhode Island.....	30	20	45	5	30	70
Connecticut.....	38	17	10	20	6	9	54	46
New York.....	40	20	11	13	9	7	60	40
New Jersey.....	30	20	10	23	6	11	46	54
Pennsylvania.....	40	14	20	9	11	6	71	29
North Atlantic.....	39.3	16.5	14.2	13.7	9.0	7.3	62.5	37.5
Delaware.....	45	10	17	15	8	5	70	30
Maryland.....	43	6	24	15	9	3	76	24
Virginia.....	27	12	25	19	10	7	62	38
West Virginia.....	23	12	28	15	15	7	66	34

TABLE 293.—Percentage of male farm labor by classes and States—Continued.

State and division.	By month—		By day, except extra harvest—		Extra harvest labor—		Percentage of all labor hired—	
	With board.	Without board.	With board.	Without board.	With board.	Without board.	With board.	Without board.
	<i>Per ct.</i>	<i>Per ct.</i>	<i>Per ct.</i>	<i>Per ct.</i>	<i>Per ct.</i>	<i>Per ct.</i>	<i>Per ct.</i>	<i>Per ct.</i>
North Carolina.....	30	14	23	16	11	6	64	36
South Carolina.....	39	21	10	17	4	9	53	47
Georgia.....	37	22	14	13	8	6	59	41
Florida.....	25	15	8	38	5	9	38	62
South Atlantic.....	33.7	17.2	17.4	16.6	8.3	6.8	55.4	40.6
Ohio.....	38	15	19	11	12	5	69	31
Indiana.....	40	19	14	10	10	7	64	36
Illinois.....	50	14	12	10	10	4	72	28
Michigan.....	40	15	20	8	13	4	73	27
Wisconsin.....	55	13	14	6	9	3	78	22
North Central east of Mississippi River.....	44.8	15.1	15.5	9.2	10.8	4.6	71.1	28.9
Minnesota.....	56	5	16	2	19	2	91	9
Iowa.....	65	10	9	3	10	3	84	16
Missouri.....	41	14	16	10	13	6	70	30
North Dakota.....	51	3	15	4	26	1	92	8
South Dakota.....	55	3	14	2	24	2	93	7
Nebraska.....	62	10	11	3	12	2	85	15
Kansas.....	45	12	15	5	19	4	79	21
North Central west of Mississippi River.....	52.7	9.4	13.8	4.8	15.9	3.4	82.4	17.6
Kentucky.....	28	18	18	18	10	8	56	44
Tennessee.....	24	16	21	22	9	8	54	46
Alabama.....	32	21	17	19	5	6	54	46
Mississippi.....	31	14	13	22	11	9	55	45
Louisiana.....	16	21	14	29	8	12	38	62
Texas.....	31	18	11	21	11	8	53	47
Oklahoma.....	32	9	19	11	20	9	71	29
Arkansas.....	32	15	12	23	8	10	52	48
South Central.....	29.0	17.0	14.8	21.0	9.7	8.5	53.5	46.5
Montana.....	57	3	14	3	22	1	93	7
Wyoming.....	75	2	11	1	9	2	95	5
Colorado.....	40	10	16	7	17	10	73	27
New Mexico.....	55	11	14	11	4	5	73	27
Arizona.....	22	13	22	20	16	7	60	40
Utah.....	25	10	12	22	21	10	58	42
Nevada.....	80				20		80	20
Idaho.....	47	6	21	3	22	1	90	10
Washington.....	44	12	18	8	14	4	76	24
Oregon.....	38	9	11	8	26	8	75	25
California.....	21	11	11	28	17	12	49	51
Far Western.....	37.4	9.5	13.7	14.9	16.9	7.6	68.0	32.0
United States.....	36.1	15.5	15.3	15.7	10.5	6.9	61.9	38.1

TABLE 294.—Wages of male farm labor by classes and States, 1910 and 1918.

State and division.	Per month.				Per day at harvest.				Per day other than harvest.			
	With board.		Without board.		With board.		Without board.		With board.		Without board.	
	1918	1910	1918	1910	1918	1910	1918	1910	1918	1910	1918	1910
Maine.....	\$46.50	\$23.50	\$65.50	\$34.50	\$3.00	\$1.50	\$3.70	\$1.95	\$2.60	\$1.23	\$3.15	\$1.60
New Hampshire.....	42.50	23.50	63.50	35.50	2.80	1.35	3.55	1.84	2.45	1.18	3.25	1.65
Vermont.....	43.00	25.00	62.00	35.50	2.82	1.75	3.60	2.25	2.35	1.21	3.05	1.60
Massachusetts.....	43.00	22.75	66.50	37.20	2.77	1.42	3.45	1.92	2.40	1.22	3.05	1.66
Rhode Island.....	40.00	21.00	62.00	34.00	2.50	1.35	3.40	2.05	2.20	1.12	3.30	1.56
Connecticut.....	44.00	21.00	63.00	36.00	2.60	1.55	3.40	2.00	2.12	1.07	2.97	1.55
New York.....	40.00	23.50	56.50	35.00	3.00	1.80	3.65	2.22	2.40	1.28	3.05	1.66
New Jersey.....	40.50	19.50	61.00	31.50	3.05	1.70	3.81	2.15	2.40	1.11	3.10	1.46
Pennsylvania.....	34.00	18.75	52.00	29.00	2.70	1.50	3.30	1.96	2.27	1.04	2.95	1.49
North Atlantic.....	38.95	21.65	57.24	33.19	2.85	1.63	3.52	2.08	2.36	1.17	3.03	1.58
Delaware.....	31.00	16.00	46.00	24.75	3.23	1.35	3.55	1.55	2.30	.98	2.80	1.22
Maryland.....	29.50	13.50	45.00	21.50	2.85	1.26	3.50	1.64	2.04	.88	2.65	1.18
Virginia.....	27.70	14.00	39.50	19.50	2.25	1.15	2.80	1.44	1.70	.78	2.25	1.01
West Virginia.....	36.90	19.40	54.50	29.00	2.50	1.28	3.10	1.65	2.00	.94	2.65	1.27
North Carolina.....	26.50	13.60	37.50	19.50	1.94	.93	2.42	1.28	1.55	.73	1.07	.97
South Carolina.....	21.00	12.00	28.00	16.50	1.50	.96	1.75	1.12	1.05	.70	1.40	.90
Georgia.....	23.00	13.00	32.60	18.00	1.62	.98	2.00	1.23	1.45	.73	1.82	.95
Florida.....	25.00	15.00	38.00	25.00	1.49	1.10	2.05	1.46	1.50	.96	2.00	1.32
South Atlantic.....	26.21	13.77	37.44	19.75	1.95	1.07	2.41	1.33	1.55	.77	2.01	1.01
Ohio.....	35.50	21.00	49.70	29.00	3.00	1.67	3.67	2.07	2.35	1.20	2.94	1.57
Indiana.....	34.00	20.50	47.00	28.40	3.05	1.70	3.65	2.07	2.15	1.14	2.65	1.45
Illinois.....	38.20	24.50	52.00	32.90	3.43	1.90	4.12	2.30	2.50	1.31	3.14	1.63
Michigan.....	37.50	23.00	52.50	33.00	2.85	1.64	3.50	2.10	2.35	1.22	3.00	1.66
Wisconsin.....	43.50	26.00	60.20	37.25	3.00	1.76	3.64	2.20	2.48	1.35	3.12	1.78
N. C. E. Miss. R.....	37.51	22.94	51.91	31.81	3.09	1.75	3.75	2.16	2.37	1.24	2.98	1.61
Minnesota.....	47.10	26.00	62.70	38.00	3.90	2.23	4.50	2.65	3.00	1.48	3.67	1.90
Iowa.....	50.00	28.00	64.00	39.00	3.65	2.12	4.30	2.51	2.90	1.57	3.55	1.98
Missouri.....	35.00	21.50	45.00	29.50	2.85	1.55	3.45	1.93	1.90	1.02	2.60	1.32
North Dakota.....	52.00	29.00	72.00	42.00	4.50	2.40	5.50	3.03	3.20	1.60	4.15	2.20
South Dakota.....	55.70	27.00	77.50	39.00	4.40	2.35	5.05	2.95	3.50	1.54	4.10	2.00
Nebraska.....	49.00	26.50	67.00	38.00	4.14	2.14	4.90	2.60	3.10	1.57	3.85	1.96
Kansas.....	40.80	24.00	56.40	34.00	4.14	2.18	4.65	2.57	2.74	1.42	3.38	1.84
N. C. W. Miss. R.....	44.68	25.10	49.32	35.45	3.72	2.01	4.36	2.43	2.72	1.38	3.41	1.77
Kentucky.....	29.00	16.00	41.00	23.10	2.40	1.36	2.90	1.71	1.62	.85	2.10	1.12
Tennessee.....	25.10	14.00	35.70	20.00	1.95	1.14	2.45	1.44	1.35	.77	1.76	1.02
Alabama.....	21.20	13.00	30.00	18.50	1.40	.98	1.80	1.26	1.30	.85	1.75	1.05
Mississippi.....	21.50	13.30	30.50	19.50	1.35	.93	1.75	1.22	1.43	.83	1.85	1.10
Louisiana.....	23.70	13.50	35.90	20.25	1.70	.90	2.10	1.25	1.57	.77	2.00	1.02
Texas.....	31.00	18.00	43.00	24.50	2.05	1.22	2.60	1.57	1.70	1.04	2.10	1.32
Oklahoma.....	35.00	19.10	50.00	28.10	3.15	1.60	3.70	1.97	2.20	1.11	2.85	1.47
Arkansas.....	28.50	16.25	40.50	24.00	2.12	1.20	2.65	1.55	1.67	.90	2.14	1.20
South Central.....	27.19	15.28	38.57	21.90	2.01	1.14	2.49	1.47	1.60	.89	2.06	1.15
Montana.....	59.50	38.00	83.00	50.00	3.80	2.05	4.75	2.80	3.15	1.77	4.10	2.36
Wyoming.....	60.00	35.00	83.00	49.00	3.60	1.90	4.50	2.50	3.05	1.73	4.00	2.29
Colorado.....	51.00	29.50	73.50	44.50	3.40	1.95	4.30	2.47	2.80	1.47	3.65	2.00
New Mexico.....	40.00	24.50	59.00	34.25	2.25	1.46	2.75	1.88	1.95	1.12	2.88	1.58
Arizona.....	56.00	30.00	80.00	40.00	2.65	1.72	3.40	2.24	2.30	1.34	3.10	2.04
Utah.....	64.00	35.00	84.00	47.50	3.15	1.78	3.80	2.20	2.60	1.55	3.50	2.00
Nevada.....	65.00	37.00	85.00	54.00	3.20	1.82	3.85	2.38	2.60	1.39	3.50	1.96
Idaho.....	64.00	35.00	86.25	49.50	3.60	2.20	4.45	2.80	3.10	1.70	3.85	2.27
Washington.....	63.00	33.00	85.00	50.00	4.00	2.42	4.75	2.78	3.15	1.72	4.05	2.26
Oregon.....	58.00	32.00	76.00	44.50	3.60	2.12	4.22	2.60	2.80	1.51	3.47	2.07
California.....	54.20	33.00	78.00	47.00	3.25	1.98	4.00	2.48	2.60	1.44	3.25	2.02
Far Western.....	56.68	32.69	78.64	46.48	3.39	2.02	4.14	2.52	2.76	1.51	3.52	2.06
United States.....	34.92	19.21	47.07	27.50	2.65	1.45	3.22	1.82	2.07	1.06	2.63	1.38

TABLE 295.—Wages of classes of male farm labor, 1866–1918.

Year.	By the month.		Day labor at harvest.		Day labor not harvest.	
	With board.	Without board.	With board.	Without board.	With board.	Without board.
1918	\$34.92	\$47.07	\$2.65	\$3.22	\$2.07	\$2.63
1917	28.87	40.43	2.08	2.54	1.56	2.02
1916	23.25	32.83	1.69	2.07	1.26	1.62
1915	21.26	30.15	1.56	1.92	1.13	1.47
1914	21.05	29.88	1.55	1.91	1.13	1.45
1913	21.38	30.31	1.57	1.94	1.16	1.50
1912	20.81	29.58	1.54	1.87	1.14	1.47
1911	20.18	28.77	1.49	1.85	1.09	1.42
1910	19.21	27.50	1.45	1.82	1.06	1.38
1902	16.40	22.14	1.34	1.53	.89	1.13
1899	14.07	20.23	1.12	1.37	.77	1.01
1898	13.43	19.38	1.05	1.30	.72	.96
1895	12.02	17.69	.92	1.14	.62	.81
1894	12.16	17.74	.93	1.13	.63	.81
1893	13.29	19.10	1.03	1.24	.69	.89
1892	12.54	18.60	1.02	1.30	.67	.92
1890	12.45	18.33	1.02	1.30	.68	.92
1888	12.36	18.24	1.02	1.31	.67	.92
1885	12.34	17.97	1.10	1.40	.67	.91
1882	12.41	18.94	1.15	1.48	.67	.93
1879	10.43	16.42	1.00	1.30	.59	.81
1875	12.72	19.87	1.35	1.70	.78	1.08
1869	16.55	25.92	1.74	2.20	1.02	1.41
1866	17.45	26.87	1.74	2.20	1.08	1.49

TREND OF PRICES, WAGES, AND LAND VALUES.

The accompanying two charts show the trend from 1909–10 to 1917–18 in the United States of values of farm lands, wages paid for monthly farm labor, average prices of farm crops, and prices of articles which farmers usually buy. The base, 100 in each case, is the average for the five years before the war, 1909–10 to 1913–14.

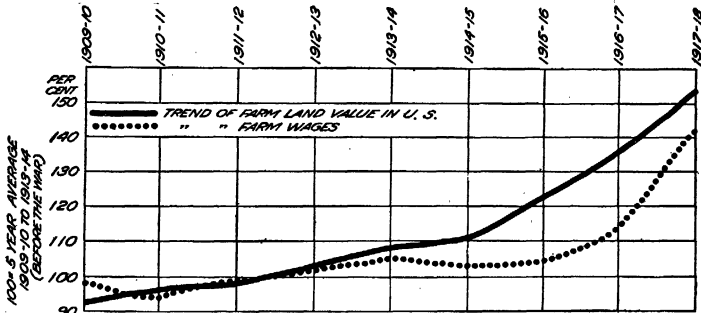

Farm wages, dotted line; land values, heavy line.

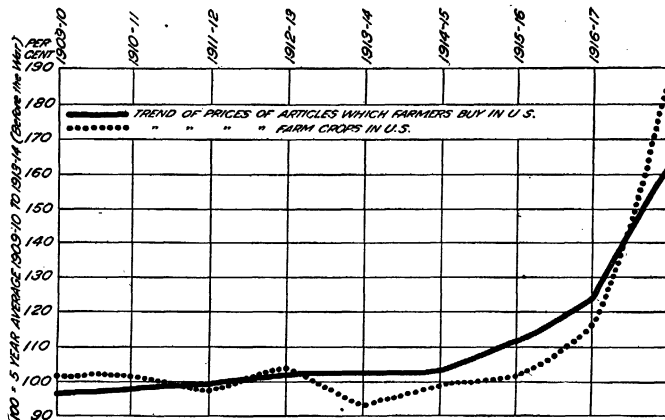

Crop prices, dotted line; articles farmers buy, heavy line.

VALUE OF PLOW LANDS.

TABLE 296.—Value of plow lands, by States, 1916-1919.

State.	Average of poor plow lands.			Average of good plow lands.			Average of all plow lands.			
	1919	1918	1917	1919	1918	1917	1919	1918	1917	1916
Maine.....	\$24.00	\$24.00	\$22.00	\$50.00	\$48.00	\$47.00	\$37.00	\$35.00	\$34.00	\$32.00
New Hampshire.....	23.00	21.00	24.00	54.00	52.00	50.00	39.00	39.00	37.00	37.00
Vermont.....	30.00	28.00	28.00	64.00	64.00	60.00	44.00	44.00	42.00	41.50
Massachusetts.....	41.00	41.00	36.00	92.00	92.00	93.00	68.00	68.00	64.00	62.00
Rhode Island.....	47.00	46.00	42.00	92.00	90.00	85.00	73.00	70.00	62.00	60.00
Connecticut.....	37.00	37.00	36.00	80.00	75.00	72.00	55.00	52.00	53.00	49.00
New York.....	38.00	33.00	34.00	80.00	75.00	74.00	60.00	58.00	55.00	53.00
New Jersey.....	50.00	58.00	46.00	103.00	108.00	92.00	76.00	78.00	69.00	65.00
Pennsylvania.....	38.00	37.00	36.00	79.00	79.00	73.00	60.00	58.00	57.00	50.00
Delaware.....	36.00	35.00	33.00	70.00	68.00	75.00	55.00	59.00	55.00	50.00
Maryland.....	39.00	33.00	30.00	66.00	61.00	62.00	53.00	47.00	48.00	46.00
Virginia.....	31.00	29.00	24.50	62.00	61.00	50.00	47.00	43.00	36.50	34.00
West Virginia.....	29.00	28.00	23.00	64.00	64.00	54.00	44.00	43.00	38.50	36.50
North Carolina.....	31.00	29.00	24.00	67.00	58.00	49.00	50.00	42.00	35.00	31.00
South Carolina.....	27.00	23.00	21.00	56.00	45.00	43.00	45.00	36.00	33.00	31.00
Georgia.....	24.50	20.00	18.00	49.30	40.00	35.50	37.50	28.00	27.50	24.00
Florida.....	21.00	21.00	20.00	48.00	42.00	37.00	33.00	32.00	27.50	26.00
Ohio.....	63.00	61.00	55.00	113.00	107.00	99.50	91.00	86.00	80.00	75.00
Indiana.....	68.00	67.00	60.00	126.00	120.00	110.50	100.00	96.50	87.00	84.00
Illinois.....	100.00	94.00	85.00	170.00	160.00	148.00	144.00	132.00	120.00	115.00
Michigan.....	40.00	38.00	35.00	76.00	75.00	72.00	61.00	60.00	55.00	51.00
Wisconsin.....	60.00	56.00	53.50	110.00	100.00	99.50	89.00	82.00	80.00	74.00
Minnesota.....	59.00	54.00	50.00	88.00	85.00	81.00	78.00	75.00	68.00	61.00
Iowa.....	129.00	119.00	104.00	196.00	180.00	163.00	169.00	154.00	140.00	135.00
Missouri.....	51.00	47.00	42.50	91.00	83.00	76.00	72.00	66.00	60.00	59.00
North Dakota.....	27.50	26.00	24.00	43.00	41.00	39.00	37.00	35.00	33.00	30.00
South Dakota.....	50.00	41.00	41.00	77.00	63.00	62.50	67.00	56.00	54.00	53.00
Nebraska.....	67.00	60.00	51.00	115.00	110.00	90.00	95.00	80.00	74.00	72.00
Kansas.....	44.00	42.00	37.00	77.00	74.00	69.00	61.00	58.00	53.00	51.00
Kentucky.....	37.00	31.00	27.00	80.00	65.00	56.00	61.00	50.00	41.00	35.00
Tennessee.....	31.00	30.00	26.00	75.00	67.00	60.00	53.00	48.00	41.00	37.00
Alabama.....	17.00	15.00	13.00	33.00	30.00	23.50	24.00	21.00	17.00	16.00
Mississippi.....	16.00	15.00	13.00	33.50	31.00	28.00	25.50	23.00	20.00	18.00
Louisiana.....	25.00	26.00	17.00	44.00	45.00	36.00	33.00	33.00	25.00	24.00
Texas.....	27.00	30.00	24.00	58.00	57.00	49.00	46.00	45.00	38.00	34.00
Oklahoma.....	24.00	23.00	19.00	51.00	48.00	42.00	38.00	35.00	30.00	27.00
Arkansas.....	22.00	20.00	17.00	50.00	45.00	39.00	38.00	31.00	27.00	22.00
Montana.....	21.00	22.00	19.00	45.00	45.00	41.00	34.00	35.00	31.50	29.00
Wyoming.....	26.00	25.00	20.00	53.00	49.00	41.00	43.00	41.00	30.00	27.00
Colorado.....	36.00	35.00	32.00	80.00	74.00	75.00	60.00	55.00	55.00	50.00
New Mexico.....	30.00	25.00	24.00	60.00	60.00	48.00	45.00	42.00	36.00	31.00
Arizona.....	60.00	52.00	55.00	125.00	116.00	108.00	100.00	98.00	85.00	80.00
Utah.....	55.00	48.00	45.00	125.00	113.00	90.00	95.00	86.00	70.00	60.00
Nevada.....	50.00	42.00	38.00	110.00	110.00	80.00	85.00	80.00	60.00	60.00
Idaho.....	50.00	43.00	37.00	98.00	89.00	77.00	76.00	70.00	58.00	53.00
Washington.....	60.00	56.00	50.00	121.00	122.00	110.00	95.00	94.00	80.00	75.00
Oregon.....	53.00	53.00	44.00	108.00	111.00	93.00	81.00	84.00	70.00	60.00
California.....	69.00	66.00	55.00	165.00	168.00	150.00	121.00	123.00	110.00	95.00
United States.....	51.26	47.86	42.67	91.83	85.48	78.34	74.31	68.38	62.17	58.39

DEPTH OF PLOWING.

The average depth of plowing practiced by farmers was a subject of inquiry among crop reporters of the Bureau of Crop Estimates. Each reporter who replied estimated the average depth plowed by farmers in his community. Separate estimates were made for fall plowing and spring plowing, respectively. For the entire United States the average of fall plowing is found to be about 5.45 inches, and of spring plowing 5.12 inches. State averages are given below:

TABLE 297.—*Plowing depth, fall and spring.*

State.	Fall.	Spring.	State.	Fall.	Spring.
	<i>Inches.</i>	<i>Inches.</i>		<i>Inches.</i>	<i>Inches.</i>
Maine.....	7.5	7.6	North Dakota.....	5.0	4.7
New Hampshire.....	7.0	6.9	South Dakota.....	5.1	5.2
Vermont.....	6.5	6.3	Nebraska.....	5.2	5.4
Massachusetts.....	7.4	7.8	Kansas.....	4.8	5.0
Rhode Island.....	6.0	6.3	Kentucky.....	5.9	6.0
Connecticut.....	6.5	6.4	Tennessee.....	6.0	5.6
New York.....	6.4	6.4	Alabama.....	5.3	4.2
New Jersey.....	6.4	6.9	Mississippi.....	4.0	3.3
Pennsylvania.....	6.7	6.5	Louisiana.....	5.0	4.3
Delaware.....	5.9	6.3	Texas.....	4.9	4.2
Maryland.....	6.3	6.5	Oklahoma.....	4.5	4.5
Virginia.....	6.6	6.5	Arkansas.....	5.0	4.4
West Virginia.....	6.1	6.0	Montana.....	5.5	5.5
North Carolina.....	6.5	5.8	Wyoming.....	5.9	5.6
South Carolina.....	5.8	4.9	Colorado.....	5.7	6.1
Georgia.....	5.1	4.0	New Mexico.....	5.6	5.2
Florida.....	5.7	4.7	Arizona.....	5.8	5.8
Ohio.....	6.4	6.9	Utah.....	7.5	6.7
Indiana.....	6.0	6.5	Nevada.....	6.6	6.7
Illinois.....	5.7	5.3	Idaho.....	6.1	6.1
Michigan.....	6.7	6.4	Washington.....	6.4	6.4
Wisconsin.....	6.0	5.7	Oregon.....	6.0	6.1
Minnesota.....	5.4	5.0	California.....	6.1	6.5
Iowa.....	5.7	5.0			
Missouri.....	5.6	5.6	United States.....	5.45	5.12

The degree of uniformity of the estimates is illustrated in the following tabulation, which classifies the returns from the adjacent States of Indiana and Illinois; thus, 204 reports were received from Illinois, of which 3 estimated the average depth of fall plowing to be 8 inches; 33 estimated 7 inches; 12 estimated 6½ inches; 70 estimated 6 inches; 12 estimated 5½ inches; 49 estimated 5 inches; 7 estimated 4½ inches; 16 estimated 4 inches; and 2 estimated less than 4 inches.

TABLE 298.—*Classification, by depths, of the returns from Illinois and Indiana on depth of fall and spring plowing.*

Depth.	Number of reports.			
	Illinois.		Indiana.	
	Fall.	Spring.	Fall.	Spring.
Over 9 inches.....	0	0	2	0
9 inches.....	0	0	2	2
8½ inches.....	0	0	1	2
8 inches.....	3	3	13	21
7½ inches.....	0	1	2	5
7 inches.....	33	11	26	50
6½ inches.....	12	7	6	11
6 inches.....	70	48	63	47
5½ inches.....	12	8	7	6
5 inches.....	49	75	34	21
4½ inches.....	7	18	8	2
4 inches.....	16	30	5	2
Less than 4 inches.....	2	3	0	0
Total.....	204	204	169	169
Average.....	5.7	5.3	6.0	6.5

The figures show clearly that in Illinois fall plowing is deeper than spring plowing, whereas in Indiana the reverse is true—namely, spring plowing is deeper than fall plowing.

INDEX NUMBERS.

TABLE 299.—*Index numbers of crop prices, monthly, 1909–1918.*

The trend of prices to farmers for important crops is indicated in the following figures; the base 100 is the average price December 1 in the 43 years 1866–1908 of wheat, corn, oats, barley, rye, buckwheat, potatoes, hay, flax, and cotton.

	1918	1917	1916	1915	1914	1913	1912	1911	1910	1909
Jan. 1.....	264.1	183.6	129.0	126.7	132.5	110.9	133.9	118.6	134.1	117.8
Feb. 1.....	271.6	195.6	139.9	140.5	132.1	112.6	140.2	119.8	138.5	120.4
Mar. 1.....	288.8	206.5	138.6	144.0	133.8	113.3	144.7	117.9	139.9	126.3
Apr. 1.....	288.6	225.2	140.2	144.5	134.2	113.6	153.4	118.0	138.8	130.6
May 1.....	281.8	230.6	143.3	150.0	135.9	116.2	166.3	122.2	133.5	139.6
June 1.....	271.9	291.3	145.8	147.3	138.8	121.2	168.3	127.7	133.5	146.5
July 1.....	272.9	289.9	144.8	139.1	137.7	122.9	160.1	136.3	133.1	149.5
Aug. 1.....	280.6	307.8	147.7	138.9	137.6	125.4	148.0	148.2	137.1	142.3
Sept. 1.....	293.3	279.6	161.5	132.5	141.3	136.3	137.6	141.6	137.0	132.9
Oct. 1.....	289.3	277.0	163.6	128.2	136.4	139.1	128.6	138.0	129.8	130.5
Nov. 1.....	269.5	261.3	178.8	124.4	127.4	133.9	118.3	135.6	122.2	129.3
Dec. 1.....	265.5	252.3	187.9	120.4	122.8	132.7	110.3	133.1	118.4	127.7

TABLE 300.—*Index numbers of crop production, prices, and values, 1910–1918.*

[100=average 5 years preceding the war, i. e. 1910–1914.]

	Total crop production.	Yield per acre.	Prices to producers.	Total crop values.
1918.....	107	99	224	241
1917.....	108	104	213	230
1916.....	100	96	155	155
1915.....	116	116	102	118
1914.....	107	104	98	105
1913.....	95	95	110	105
1912.....	110	109	91	100
1911.....	91	92	104	96
1910.....	97	100	97	94

TABLE 301.—*Index numbers of prices of meat animals, monthly and average, 1912–1918.*

Date.	1918	1917	1916	1915	1914	1913	1912	Average.
Jan. 15.....	12.59	8.53	6.46	6.57	7.05	6.40	5.44	7.58
Feb. 15.....	12.65	9.42	6.94	6.46	7.27	6.70	5.54	7.85
Mar. 15.....	13.06	10.70	7.53	6.46	7.37	7.08	5.69	8.27
Apr. 15.....	13.55	11.71	7.85	6.59	7.40	7.35	6.30	8.68
May 15.....	13.83	11.84	7.98	6.80	7.29	7.08	6.39	8.74
June 15.....	13.62	11.72	8.00	6.85	7.22	7.19	6.27	8.70
July 15.....	13.68	11.47	8.04	6.83	7.41	7.25	6.23	8.70
Aug. 15.....	14.21	11.84	8.05	6.74	7.63	7.20	6.56	8.89
Sept. 15.....	14.50	12.79	8.38	6.77	7.58	7.15	6.74	9.13
Oct. 15.....	13.79	13.04	8.04	6.96	7.14	7.14	6.86	9.00
Nov. 15.....	13.37	12.47	8.09	6.45	6.80	6.94	6.45	8.65
Dec. 15.....	13.40	12.74	8.15	6.25	6.61	6.85	6.42	8.63
Average.....	13.52	11.52	7.79	6.64	7.23	7.03	6.24	8.57

LIVE STOCK.

TABLE 302.—Number and value of live stock in the United States, January 1, 1910–1919.

Farm animals.	Number.		Value.	
	Per cent of preceding year.	Total number.	Per head.	Aggregate.
Horses, Jan. 1:				
1919.....	99.9	21,534,000	\$98.48	\$2,120,709,000
1918.....	101.6	21,555,000	104.24	2,246,970,000
1917.....	100.2	21,210,000	102.89	2,182,307,000
1916.....	99.8	21,159,000	101.60	2,149,786,000
1915.....	101.1	21,195,000	103.33	2,190,102,000
1914.....	101.9	20,962,000	109.32	2,291,638,000
1913.....	100.3	20,567,000	110.77	2,278,222,000
1912.....	101.1	20,509,000	105.94	2,172,694,000
1911.....	102.2	20,277,000	111.46	2,259,981,000
1910.....		¹ 19,833,000	108.03	2,142,524,000
Mules, Jan. 1:				
1919.....	101.1	4,925,000	135.59	667,767,000
1918.....	103.2	4,873,000	128.81	627,679,000
1917.....	102.8	4,723,000	118.15	558,006,000
1916.....	102.5	4,593,000	113.83	522,834,000
1915.....	100.7	4,479,000	112.36	503,271,000
1914.....	101.4	4,449,000	123.85	551,017,000
1913.....	100.6	4,386,000	124.31	545,245,000
1912.....	100.9	4,362,000	120.51	525,657,000
1911.....	102.7	4,323,000	125.92	544,359,000
1910.....		¹ 4,210,000	120.20	506,049,000
Milch cows, Jan. 1:				
1919.....	100.7	23,467,000	78.24	1,836,055,000
1918.....	101.8	23,310,000	70.54	1,644,231,000
1917.....	103.6	22,894,000	59.63	1,365,251,000
1916.....	104.0	22,108,000	53.92	1,191,955,000
1915.....	102.5	21,262,000	55.33	1,176,338,000
1914.....	101.2	20,737,000	53.94	1,118,487,000
1913.....	99.0	20,497,000	45.02	922,783,000
1912.....	99.4	20,699,000	39.39	815,414,000
1911.....	100.9	20,823,000	39.97	832,209,000
1910.....		¹ 20,625,000	35.29	727,802,000
Other cattle, Jan. 1:				
1919.....	100.7	44,399,000	44.16	1,960,670,000
1918.....	105.8	44,112,000	40.88	1,803,482,000
1917.....	104.7	41,689,000	35.92	1,497,621,000
1916.....	107.4	39,812,000	33.53	1,334,928,000
1915.....	103.4	37,067,000	33.38	1,237,376,000
1914.....	99.5	35,855,000	31.13	1,116,333,000
1913.....	96.7	36,030,000	26.36	949,645,000
1912.....	93.9	37,260,000	21.20	790,064,000
1911.....	96.4	39,679,000	20.54	815,184,000
1910.....		¹ 41,178,000	19.07	785,261,000
Sheep, Jan. 1:				
1919.....	102.6	49,863,000	11.61	579,016,000
1918.....	102.1	48,603,000	11.82	574,575,000
1917.....	97.9	47,616,000	7.13	339,529,000
1916.....	97.3	48,625,000	5.17	251,594,000
1915.....	100.5	49,956,000	4.50	224,687,000
1914.....	96.6	49,719,000	4.02	200,045,000
1913.....	98.3	51,482,000	3.94	202,779,000
1912.....	97.6	52,362,000	3.46	181,170,000
1911.....	102.3	53,633,000	3.91	209,535,000
1910.....		¹ 52,448,000	4.12	216,030,000
Swine, Jan. 1:				
1919.....	106.5	75,587,000	22.04	1,665,987,000
1918.....	105.1	70,978,000	19.54	1,387,261,000
1917.....	99.6	67,503,000	11.75	792,898,000
1916.....	104.9	67,766,000	8.40	569,573,000
1915.....	109.6	64,618,000	9.87	637,479,000
1914.....	96.3	58,933,000	10.40	612,951,000
1913.....	93.5	61,178,000	9.86	603,109,000
1912.....	99.7	65,410,000	8.00	523,328,000
1911.....	112.8	65,620,000	9.37	615,170,000
1910.....		¹ 58,186,000	9.17	533,309,000

¹ Census report of numbers Apr. 15, 1910.

TABLE 303.—Aggregate live-stock value comparisons, 1918, 1919, and average 1913-1917.

[Farm values Jan. 1, in millions of dollars, i. e., 000,000 omitted; States arranged according to 1919 rank in value of meat animals.]

States.	Cattle, hogs, and sheep.			Horses and mules.			Total (cattle, hogs, sheep horses, and mules).			Rank in aggregate value, 1919.
	1919	1918	Av., 1913-1917.	1919	1918	Av., 1913-1917.	1919	1918	Av., 1913-1917.	
Iowa.....	588	514	292	157	173	182	745	687	474	1
Illinois.....	327	275	160	165	169	179	492	444	339	2
Nebraska.....	320	306	168	103	119	108	423	425	276	4
Texas.....	273	282	239	182	180	174	455	462	413	3
Missouri.....	268	250	143	139	142	136	407	392	279	5
Wisconsin.....	268	233	155	76	83	90	344	316	245	8
Ohio.....	264	235	136	99	104	116	363	339	252	7
Kansas.....	262	246	150	138	152	134	400	398	284	6
Minnesota.....	249	206	118	94	101	102	343	307	220	9
Indiana.....	226	181	107	97	99	106	323	280	213	10
New York.....	202	193	128	81	87	86	283	280	214	11
South Dakota.....	182	157	84	68	79	72	250	236	156	12
California.....	177	163	109	47	53	58	224	216	167	15
Pennsylvania.....	161	138	92	78	81	84	239	219	176	13
Michigan.....	157	141	92	70	80	88	227	221	180	14
Colorado.....	131	122	68	42	42	33	173	164	101	19
Oklahoma.....	121	123	79	94	101	91	215	224	170	16
Wyoming.....	119	116	59	18	18	14	137	134	73	25
Montana.....	117	115	71	47	50	37	164	165	108	21
Georgia.....	104	79	40	89	79	65	193	158	105	17
Kentucky.....	102	87	52	75	72	68	177	159	120	18
New Mexico.....	92	91	54	18	19	14	110	110	68	30
Mississippi.....	90	68	34	73	63	54	163	131	86	22
Alabama.....	88	69	32	68	59	50	156	128	82	24
Virginia.....	85	65	39	49	46	45	134	111	84	26
Tennessee.....	84	66	40	80	74	70	164	140	110	20
Oregon.....	83	76	46	28	30	29	111	106	75	29
Idaho.....	81	79	42	25	27	23	106	106	65	32
North Dakota.....	78	69	46	80	87	88	158	156	134	23
Arizona.....	69	69	39	11	11	9	80	80	48	34
Arkansas.....	67	63	34	64	63	49	131	126	83	27
North Carolina.....	67	50	30	63	61	53	130	111	83	28
Louisiana.....	65	53	29	45	40	33	110	93	62	31
Utah.....	60	61	30	12	13	13	72	74	43	37
West Virginia.....	53	47	31	21	22	23	74	69	54	35
Florida.....	52	42	23	14	14	11	66	56	34	38
South Carolina.....	47	32	17	55	48	39	102	80	56	33
Nevada.....	46	48	28	5	6	6	51	54	34	40
Washington.....	44	42	30	30	35	32	74	77	62	36
Maryland.....	32	26	17	21	21	22	53	47	39	39
Vermont.....	31	32	20	12	13	11	43	45	31	41
New Jersey.....	26	21	15	13	14	14	39	35	29	42
Massachusetts.....	23	21	14	8	9	10	31	30	24	44
Maine.....	22	21	13	16	18	16	38	39	29	43
Connecticut.....	16	15	11	7	7	7	23	22	18	45
New Hampshire.....	14	13	8	6	6	6	20	19	14	46
Delaware.....	6	5	3	4	4	4	10	9	7	47
Rhode Island.....	3	3	2	1	1	1	4	4	3	48
United States.....	6,042	5,409	3,269	2,788	2,875	2,755	8,830	8,284	6,024

TABLE 304.—Prices of live stock by ages or classes, United States, 1913-1919.

Cattle.	1919	1918	1917	1916	1915	1914	1913
Horses:							
Under 1 year old.....	\$42.50	\$45.20	\$45.17	\$44.30	\$45.36	\$47.95	\$48.75
1 and under 2 years.....	66.10	70.20	70.21	69.02	70.62	74.87	76.54
2 years and over.....	108.10	114.30	112.64	111.28	113.10	119.77	121.06
Mules:							
Under 1 year old.....	59.30	57.60	53.98	51.47	51.80	57.45	59.31
1 and under 2 years.....	89.20	86.30	80.28	76.69	76.46	83.87	86.56
2 years and over.....	149.30	139.90	128.17	123.59	121.46	133.76	134.05
Other cattle (than milk):							
Under 1 year.....	25.00	23.40	20.71	19.08	19.06	17.84	14.90
1 and under 2 years.....	41.60	38.60	33.93	31.48	31.21	29.77	25.11
2 years and over.....	60.20	55.60	48.63	45.81	45.92	42.77	36.38
Sheep:							
Under 1 year.....	8.80	9.10	5.63	4.13	3.62	3.22	3.11
Ewes 1 year and over.....	12.40	12.70	7.48	5.35	4.59	4.09	3.98
Wethers 1 year and over.....	11.00	11.20	6.78	5.02	4.48	4.06	3.93
Rams.....	22.00	20.80	13.62	10.32	9.01	8.49	8.80

TABLE 305.—Yearly marketings of live stock at principal markets, 1900–1918.

Year.	Cattle.		Hogs.		Sheep.	
	Receipts.	Shipments.	Receipts.	Shipments.	Receipts.	Shipments.
1900.....	7,179,344	3,793,308	18,573,177	5,336,826	7,061,466	2,500,686
1901.....	7,708,839	3,888,460	20,339,864	5,772,717	7,798,359	2,712,866
1902.....	8,375,408	4,292,705	17,289,427	4,130,675	9,177,050	3,561,060
1903.....	8,878,789	4,490,748	16,780,250	4,233,572	9,680,692	3,983,310
1904.....	8,690,699	4,552,554	17,778,827	5,254,545	9,604,812	4,203,834
1905.....	9,202,083	4,964,753	18,988,933	5,614,306	10,572,259	4,725,872
1906.....	9,373,825	5,026,689	19,223,792	5,440,333	10,864,437	5,046,366
1907.....	9,590,710	5,360,790	19,544,617	5,993,069	9,857,877	4,549,000
1908.....	8,827,360	4,936,731	22,863,701	7,288,403	9,833,640	4,489,295
1909.....	9,189,312	5,181,446	18,420,012	6,381,667	10,284,858	4,172,388
1910.....	9,116,687	5,122,984	14,853,472	4,628,760	12,366,375	6,013,215
1911.....	8,629,109	4,805,766	19,276,547	6,418,246	13,521,492	5,891,034
1912.....	8,061,494	4,318,648	19,771,825	6,096,906	13,733,980	5,369,402
1913.....	7,904,552	4,596,085	19,924,331	6,414,815	14,037,830	6,046,260
1914.....	7,182,239	3,993,663	18,272,091	5,816,069	13,272,491	5,331,449
1915.....	7,963,591	3,944,152	21,031,405	6,823,983	11,160,246	4,370,504
1916.....	9,319,851	4,713,700	25,345,802	8,264,752	11,639,022	4,640,615
1917.....	11,241,038	5,676,015	20,945,301	7,151,995	10,017,353	4,534,489
1918.....	12,936,068	5,388,838	25,461,514	7,111,935	12,064,416	5,749,835

Figures for 1900–1909, inclusive, were taken from the Monthly Summary of Commerce and Finance of the United States; 1910 and subsequently from official reports of the stockyards in the cities mentioned.

The receipts of calves (not included in "Cattle") at the stockyards of Chicago, Kansas City, St. Joseph, St. Paul, and Sioux City, combined, were about 1,361,787 in 1918, 1,180,063 in 1917, 918,778 in 1916, 726,145 in 1915, 664,000 in 1914, 741,000 in 1913, about 910,000 in 1912, 975,000 in 1911, 981,000 in 1910, and 889,000 in 1909.

WEIGHT OF MATURE FARM HORSES AND MULES.

The weight of a mature farm horse, average for the United States, is 1,203 pounds. Washington, the most northwestern State of the Union, has the highest State average, 1,350 pounds, seconded by Maine, the most northeastern State, with 1,325 pounds. Lightest weight horses are found in Florida, the most southeastern State, with an average weight of 850 pounds.

Mature mules on farms of the United States average 956 pounds. Washington again leads, with 1,110 pounds, followed by Oregon, with 1,100 pounds. Lightest mules are found in Mississippi, where the average is 865 pounds.

In most States horses average in weight heavier than mules, but the difference appears to diminish as one goes southward; and in three southern States, Georgia, Florida, and Louisiana, mules average heavier than horses.

These estimates are based upon several thousand reports of special live-stock reporters of the Bureau of Crop Estimates. Their individual estimates vary consistently with each other. For example, in Wisconsin, of 152 reports received, 134 were within a range of 200 pounds; and part of this range was due to actual differences in different parts of the State; 40 of the 152 reporters estimated exactly 1,300 pounds.

TABLE 306.—Weight of horses and mules, by States.

States.	Horses.	Mules.	States.	Horses.	Mules.
	Lbs.	Lbs.		Lbs.	Lbs.
Maine.....	1,325	1,050	North Dakota.....	1,290	1,040
New Hampshire.....	1,270	1,050	South Dakota.....	1,245	1,010
Vermont.....	1,200	1,000	Nebraska.....	1,255	1,040
Massachusetts.....	1,255	1,040	Kansas.....	1,220	1,040
Rhode Island.....	1,290	1,020	Kentucky.....	1,010	950
Connecticut.....	1,220	1,040	Tennessee.....	990	890
New York.....	1,180	995	Alabama.....	895	895
New Jersey.....	1,220	1,010	Mississippi.....	870	865
Pennsylvania.....	1,210	1,000	Louisiana.....	900	940
Delaware.....	1,080	920	Texas.....	1,000	930
Maryland.....	1,150	995	Oklahoma.....	1,080	960
Virginia.....	1,100	950	Arkansas.....	960	890
West Virginia.....	1,165	950	Montana.....	1,290	1,010
North Carolina.....	980	880	Wyoming.....	1,290	1,030
South Carolina.....	950	925	Colorado.....	1,230	1,050
Georgia.....	940	970	New Mexico.....	1,030	920
Florida.....	850	970	Arizona.....	1,150	970
Ohio.....	1,310	1,040	Utah.....	1,070	1,020
Indiana.....	1,255	1,040	Nevada.....	1,200	980
Illinois.....	1,270	1,050	Idaho.....	1,270	1,050
Michigan.....	1,295	1,040	Washington.....	1,350	1,110
Wisconsin.....	1,300	1,025	Oregon.....	1,310	1,100
Minnesota.....	1,305	1,035	California.....	1,285	1,065
Iowa.....	1,320	1,050			
Missouri.....	1,180	1,015			
			United States.....	1,203	956

HORSES PER PLOW.

TABLE 307.—Horses used per plow, by States.

Maine.....	2.0	North Carolina.....	1.9	South Dakota.....	4.1	Wyoming.....	3.7
New Hampshire.....	2.0	South Carolina.....	1.5	Nebraska.....	3.6	Colorado.....	3.4
Vermont.....	2.2	Georgia.....	1.6	Kansas.....	3.7	New Mexico.....	2.9
Massachusetts.....	2.0	Florida.....	1.6	Kentucky.....	2.2	Arizona.....	3.3
Rhode Island.....	2.0	Ohio.....	2.5	Tennessee.....	2.1	Utah.....	3.3
Connecticut.....	2.0	Indiana.....	3.0	Alabama.....	1.4	Nevada.....	3.1
New York.....	2.2	Illinois.....	3.5	Mississippi.....	1.4	Idaho.....	2.9
New Jersey.....	2.2	Michigan.....	2.6	Louisiana.....	2.4	Washington.....	2.9
Pennsylvania.....	2.2	Wisconsin.....	2.6	Texas.....	3.2	Oregon.....	3.4
Delaware.....	2.7	Minnesota.....	3.3	Oklahoma.....	3.0	California.....	4.2
Maryland.....	2.9	Iowa.....	3.7	Arkansas.....	2.0		
Virginia.....	2.3	Missouri.....	2.8	Montana.....	3.7		
West Virginia.....	2.1	North Dakota.....	4.6			United States.....	2.7

CYCLE OF LIVE-STOCK PRICES.

Live-stock prices, like prices of most farm products, have regular cycles, normally highest in certain months and lowest in other months. The cycles for the different classes of live stock do not coincide; thus, hogs are highest in September and lowest in December; cattle are highest about May and lowest in December. The following charts show the normal cycle of monthly prices of horses, cows, beef cattle, hogs, sheep, and lambs, based upon average level of United States farm prices before the war:

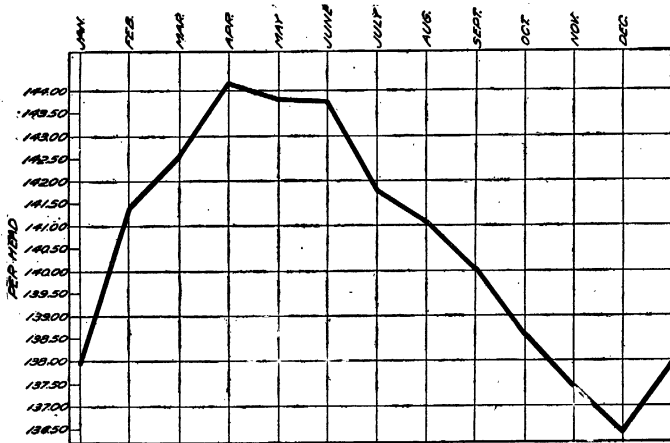

Horses—prices highest in April, lowest in December.

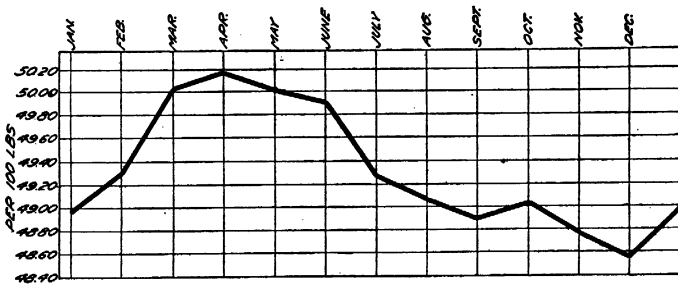

Cows—prices highest in April, lowest in December, a slight rise in October.

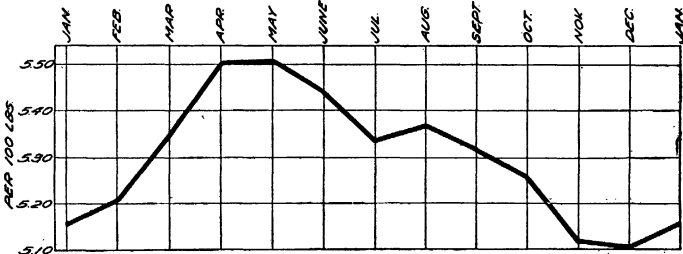

Beef cattle—prices highest about May 1, lowest in December, a slight rise in August.

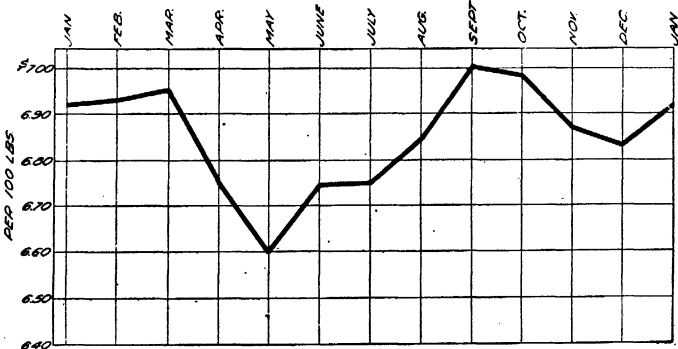

Calves—really two cycles in the year; from highest prices in September prices decline until December, then advance again until March, and decline again to low point in May.

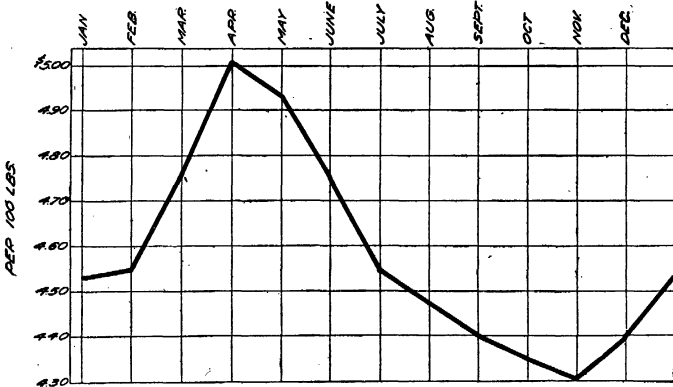

Sheep—prices highest in April, lowest in November. Range 16 per cent from lowest to highest.

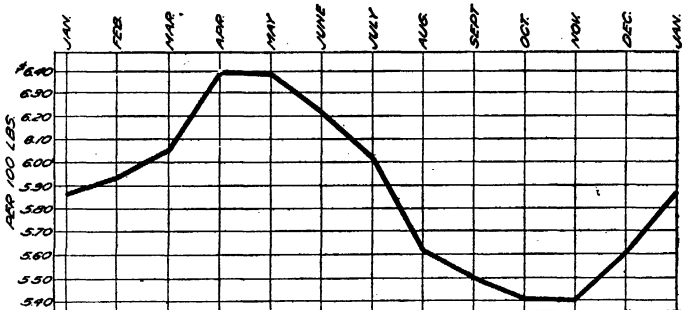

Lambs—prices highest about May 1, lowest about November 1. Range 18 per cent from lowest to highest.

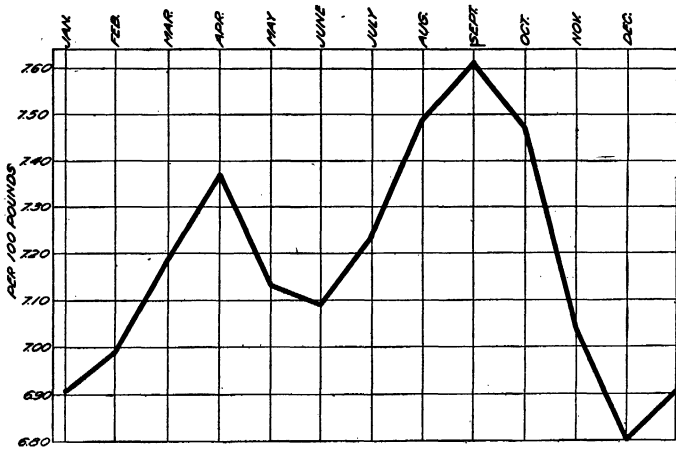

Swine—a double cycle. Prices are highest in September and decline to lowest in December, then advance to April, and decline again (after spring farrowing) to June, after which they advance to September. Range from lowest to highest, 12 per cent.

FOREIGN TRADE.

TABLE 308.—United States foreign trade in meat animals and meat products, 1904–1918.

[The following tabulation gives in round numbers the domestic exports and imports of meat animals, meats, and meat products yearly since 1904. Numbers of animals are given in thousands (i.e., 000 omitted). Quantities of meats and fats are given in millions of pounds, i. e., 000,000 omitted.]

[United States Bureau of Foreign and Domestic Commerce.]

Year ending June 30—	Cattle.		Sheep.		Swine.	Meats.		Fats and oils.	
	Ex-ports.	Im-ports.	Ex-ports.	Im-ports.	Ex-ports.	Ex-ports.	Im-ports.	Ex-ports.	Im-ports.
1904	593	16	301	238	6	1,815	1	810	1
1905	568	28	268	187	44	1,802	3	827	3
1906	584	29	143	241	59	2,206	2	1,061	2
1907	423	32	135	225	24	1,968	2	958	1
1908	349	92	101	225	31	1,828	2	912	1
1909	208	139	68	103	19	1,484	4	767	4
1910	139	196	45	126	4	1,037	11	523	8
1911	150	183	121	53	9	1,193	9	687	6
1912	106	318	157	22	19	1,356	11	766	5
1913	25	425	187	15	15	1,196	15	695	10
1914	18	872	153	224	10	1,115	205	630	5
1915	5	539	47	153	8	1,544	226	620	2
1916	21	439	52	236	22	1,956	101	602	1
1917	13	375	59	160	22	1,950	22	566	1
1918	18	294	8	178	9	1,840	30	476	7

MILK PRODUCTION OF THE UNITED STATES.

The production of milk in the United States during 1918 was about 4 per cent more than in 1917, according to reports made by crop reporters of the Bureau of Crop Estimates. The yield per cow is estimated to be 8.2 quarts per day for 287 days of the year (equaling 588 gallons) in 1918, and 8 quarts for 285 days (570 gallons) in 1917.

To estimate the total production of milk, it is not proper to apply the above estimated yield per cow to the number of milk cows as reported by the Department of Agriculture, because this figure is based upon the Census classification, which includes some heifers not yet fresh. Making what seems to be proper allowance for this (applying yield per cow to 80 per cent of the total as reported by the Department of Agriculture) indications seem to be that the total production on farms in 1918 was about 11,044,000,000 gallons; and in 1917, about 10,629,000,000 gallons. These estimates do not include production of cows not on farms (i. e., those in towns and villages), which would add about 5 per cent to the estimates above for the total production of the United States.

SWINE LOSSES YEARLY FROM DISEASE.

The chart on this page shows for the United States the yearly trend of losses by disease of hogs in the past 35 years. Inquiries are made about March each year, and refer to losses during the past year; the labeling of the chart are years of inquiry in March, so that most of the losses shown for each year actually occurred the year before. Two interesting facts are brought out in the chart; in the past 35 years there were three epidemics, their peaks being in 1886-7, 1896-7, and 1913-14; the duration of each epidemic was about six years. During the period there has been a tendency toward a gradual diminution of losses, the smallest losses, 41 per thousand, occurring the past year.

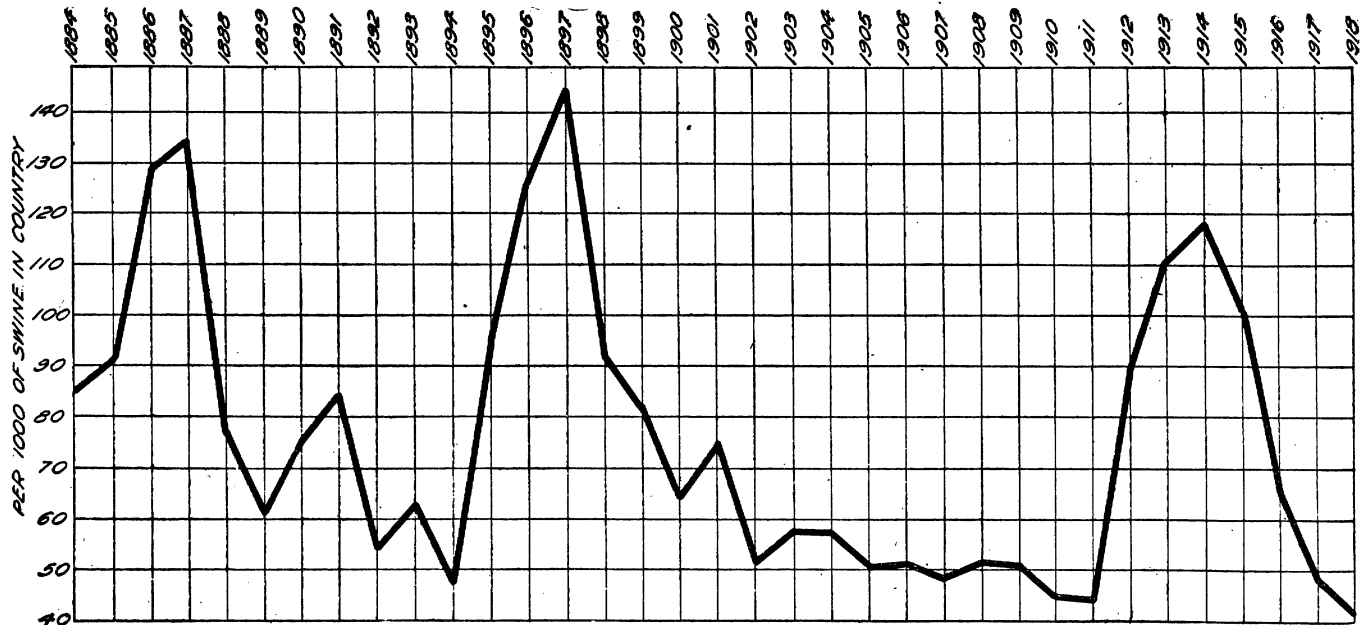

MATERIALS USED IN BREWING.

TABLE 309.—Materials used by brewers in the production of fermented liquors in the United States.

[Office of Internal Revenue, Treasury Department.]

Material.	Unit of quantity.	July 1, 1915, to June 30, 1916.	July 1, 1916, to June 30, 1917.	July 1, 1917, to June 30, 1918.
Malt.....	Bushels.....	57,683,970	81,498,959	36,097,096
Hops.....	Pounds.....	37,451,610	41,958,753	33,481,415
Rice.....	do.....	141,249,292	125,632,269	78,942,550
Corn or cerealine.....	do.....	650,745,703	666,401,619	459,842,338
Grape sugar or maltose.....	do.....	54,934,621	63,213,698	36,723,665
Glucose or sirup.....	Gallons.....	2,742,854	6,557,269	3,495,658
Grits.....	Pounds.....	109,371,482	193,263,640	66,573,282
Other materials.....	Bushels.....	72,355	180,436	35,296
Do.....	Gallons.....	19,112	16,656	24,109
Do.....	Pounds.....	24,756,974	15,573,893	5,491,879
Total all items, estimated.....	Pounds.....	3,004,754,590	3,938,987,318	1,909,998,457

HOP MOVEMENT AND CONSUMPTION.

The total hop movement of the United States for the last 11 years is shown in the annexed table. The figures on the quantity consumed by brewers have been compiled from the records of the Treasury Department; exports and imports are as reported by the Department of Commerce.

TABLE 310.—Hop consumption and movement, 1908–1918.

Year ending June 30—	Consumed by brewers.	Exports.		Total of brewers' consumption and exports.	Imports.	Net domestic movement.
		Domestic.	Foreign.			
	Pounds.	Pounds.	Pounds.	Pounds.	Pounds.	Pounds.
1918.....	33,481,415	3,494,579	37,823	37,013,817	121,288	36,892,529
1917.....	41,949,225	4,874,876	26,215	46,850,316	233,849	46,613,467
1916.....	37,451,610	22,409,818	134,571	59,995,999	676,704	59,320,295
1915.....	38,839,294	16,210,443	16,947	55,066,684	11,651,332	43,415,352
1914.....	43,987,623	24,262,896	30,224	68,280,743	5,382,025	62,898,718
1913.....	44,237,735	17,591,195	35,859	61,864,789	8,494,144	53,370,645
1912.....	42,436,665	12,190,663	35,869	54,663,197	2,991,125	51,672,072
1911.....	45,068,811	13,104,771	17,974	58,191,559	8,557,531	49,634,028
1910.....	43,293,764	10,589,254	14,590	53,897,608	3,200,560	50,697,048
1909.....	40,813,804	10,446,884	26,197	51,286,885	7,386,574	43,900,311
1908.....	42,988,257	22,920,480	94,631	36,003,368	8,493,265	57,510,103

FARM PRICES.

TABLE 311.—Turnips: Farm price, cents per bushel, 15th of month, 1912–1918.

Date.	1918	1917	1916	1915	1914	1913	1912
Jan. 15.....	88.4	78.6	48.6	49.2	56.8	49.6
Feb. 15.....	89.9	91.1	49.6	51.1	60.0	51.2
Nov. 15.....	79.6	76.4	68.4	45.9	47.4	56.1	44.6
Dec. 15.....	79.0	81.1	73.3	45.1	48.4	55.1	49.1

TABLE 312.—Cabbage: Farm price, per 100 pounds, 15th of month, 1910–1918.

Date.	1918	1917	1916	1915	1914	1913	1912	1911	1910
Jan. 15.....	\$2.74	\$3.95	\$1.17	\$1.36	\$1.87	\$1.26	\$1.89	\$1.56	\$1.87
Feb. 15.....	3.26	5.65	1.21	1.41	2.07	1.17	2.24	1.48	2.05
Mar. 15.....	2.86	6.77	1.38	1.38	2.03	1.03	2.88	1.26	2.14
Apr. 15.....	2.98	7.61	1.50	1.99	2.24	1.15	3.17	1.33	2.29
May 15.....	3.23	7.53	1.93	2.53	2.05	1.58	2.98	1.38	2.77
June 15.....	3.55	5.10	2.27	2.34	2.61	2.18	2.67	2.46	2.19
July 15.....	3.41	3.23	2.15	1.95	2.66	2.64	2.29	2.93	2.27
Aug. 15.....	2.93	2.19	2.26	1.61	1.74	2.15	1.88	2.47	1.89
Sept. 15.....	2.45	1.76	2.17	1.24	1.50	1.79	1.25	1.94	1.94
Oct. 15.....	2.16	1.79	2.40	1.00	1.31	1.69	1.08	1.58	1.53
Nov. 15.....	1.99	2.66	2.61	.97	1.14	1.58	1.04	1.51	1.36
Dec. 15.....	2.05	2.23	3.04	1.07	1.26	1.75	1.15	1.83	1.49

TABLE 313.—Onions: Farm price, cents per bushel, 15th of month, 1910–1918.

Date.	1918	1917	1916	1915	1914	1913	1912	1911	1910
Jan. 15.....	178.9	208.4	113.2	88.9	121.0	81.6	117.0	101.0	94.4
Feb. 15.....	183.2	357.9	126.3	97.6	140.7	77.5	140.0	104.0	100.1
Mar. 15.....	147.0	476.2	130.3	95.3	155.2	77.0	167.0	105.0	92.5
Apr. 15.....	134.1	495.6	123.5	104.4	159.2	79.0	175.0	119.0	103.4
May 15.....	134.7	398.0	123.3	102.9	152.6	87.2	177.0	129.0	102.8
June 15.....	138.7	308.0	133.8	102.9	140.8	95.6	155.0	134.0	105.8
July 15.....	162.6	201.0	147.3	93.0	170.4	101.7	114.0	122.0	104.5
Aug. 15.....	164.7	154.7	133.5	86.3	137.9	105.1	100.0	116.0	99.8
Sept. 15.....	163.3	142.9	122.9	82.8	103.3	103.9	89.0	104.0	99.4
Oct. 15.....	143.2	157.5	131.4	94.8	88.3	110.2	85.0	102.0	93.2
Nov. 15.....	143.1	176.6	153.8	94.8	84.4	114.9	84.0	103.0	94.6
Dec. 15.....	131.7	177.0	175.7	99.6	92.3	114.9	84.0	113.0	98.8

TABLE 314.—Turkeys and chickens: Farm price, cents per pound, 15th of month, 1914–1919.

Date.	1918–19		1917–18		1916–17		1915–16		1914–15	
	Turkeys.	Chickens.	Turkeys.	Chickens.	Turkeys.	Chickens.	Turkeys.	Chickens.	Turkeys.	Chickens.
Oct. 15.....	23.9	22.2	20.0	18.5	17.0	14.4	13.7	11.8	14.1	12.0
Nov. 15.....	25.7	21.7	21.0	17.0	18.6	13.9	14.8	11.5	14.1	11.1
Dec. 15.....	27.0	22.4	23.0	17.5	19.6	13.6	15.5	11.2	14.5	10.7
Jan. 15.....	27.3	22.1	22.9	18.4	19.5	14.1	15.6	11.5	14.5	10.9

RAILWAY FREIGHT TONNAGE.

TABLE 315.—Tonnage carried on railways in the United States, 1915-1917.¹

Product.	Year ending June 30—		Year ending Dec. 31—	
	Class I and II roads.		Class I roads.	
	1915	1916	1916	1917
FARM PRODUCTS.				
Animal matter:	<i>Short tons.</i>	<i>Short tons.</i>	<i>Short tons.</i>	<i>Short tons.</i>
Animals, live.....	15,021,432	16,963,922	17,294,304	17,905,829
Packing-house products—				
Dressed meats.....	2,503,317	2,656,235	2,807,571	2,965,709
Hides and leather.....	1,149,930	1,400,858	1,396,132	1,357,265
Other packing-house products.....	2,540,376	2,774,708	2,633,043	2,566,603
Total packing-house products.....	6,193,623	6,831,801	6,836,746	6,889,577
Poultry (including game and fish).....	861,670	1,016,484	1,096,624	1,022,472
Wool.....	370,426	503,248	504,927	499,054
Other animal matter.....	4,212,584	4,629,143	4,740,560	5,541,214
Total animal matter.....	26,659,735	29,944,598	30,473,161	31,858,146
Vegetable matter:				
Cotton.....	5,012,705	4,052,241	4,212,062	3,552,222
Fruit and vegetable.....	17,898,288	18,192,083	17,621,285	17,678,958
Grain and grain products—				
Grain.....	53,446,686	57,686,165	55,684,841	46,372,019
Grain products—				
Flour.....	9,596,763	10,472,225	10,318,950	10,065,219
Other grain products.....	8,036,745	7,992,496	8,234,081	8,413,089
Total grain and grain products.....	71,080,194	76,150,886	74,237,872	64,850,327
Hay.....	7,649,093	7,312,879	7,243,164	8,314,485
Sugar.....	3,727,194	3,017,381	3,762,495	4,235,353
Tobacco.....	1,051,648	1,085,843	1,016,198	1,028,771
Other vegetable matter.....	10,347,913	8,988,002	9,304,818	9,204,495
Total vegetable matter.....	116,767,035	119,699,295	117,397,894	108,864,611
Total farm products.....	143,426,770	149,643,893	147,871,055	140,722,757
OTHER FREIGHT.				
Products of mines.....	556,581,950	706,029,210	680,122,775	732,655,519
Products of forests.....	93,971,282	106,856,873	93,819,387	100,838,196
Manufactures.....	132,410,447	182,916,449	185,024,643	188,795,813
All other (including all freight in less than car-load lots).....	76,013,494	92,776,482	95,162,207	101,006,438
Total tonnage.....	1,002,403,943	1,238,222,907	1,202,000,067	1,264,018,723

¹ Compiled from reports of the Interstate Commerce Commission. Original shipments only, excluding freight received by each railway from connecting railways and other carriers. Figures exclude the relatively small tonnage originating on railroads of class III (roads having operating revenues of less than \$1,000,000 a year), except that for the calendar years 1916 and 1917 only Class I roads are included (roads having annual operating revenues in excess of \$1,000,000).

WAGON AND MOTOR TRUCK HAULS.

TABLE 316.—Wagon and motor-truck hauls from farms to shipping points, 1906 and 1918.

Item.	Distance.	Round trips per day.	Load.			Cost of hauling per ton per mile.		
			Corn. ¹	Wheat.	Cotton.	Corn.	Wheat.	Cotton.
United States:	<i>Miles.</i>	<i>Number.</i>	<i>Bushels.</i>	<i>Bushels.</i>	<i>Bales.</i>	<i>Cents.</i>	<i>Cents.</i>	<i>Cents.</i>
Motor trucks, 1918..	11.3	3.4	58	84	6.6	15	15	18
Wagons, 1918.....	9.0	1.2	39	56	3.6	33	30	48
Wagons, 1906.....	9.7	1.2	39	55	3.4	19	19	27
<i>Geographic division.²</i>								
New England:								
Motor trucks, 1918..	10.0	4.5	62	60	11	14
Wagons, 1918.....	7.2	1.8	38	45	39	38
Wagons, 1906.....	7.2	1.7
Middle Atlantic:								
Motor trucks, 1918..	12.2	3.4	69	78	14	14
Wagons, 1918.....	7.6	1.6	39	47	39	38
Wagons, 1906.....	6.5	1.7	41	48	24	26
South Atlantic:								
Motor trucks, 1918..	9.8	4.0	45	57	6.0	19	18	20
Wagons, 1918.....	8.4	1.4	29	36	3.5	41	39	48
Wagons, 1906.....	9.9	1.2	35	42	3.1	28	24	27
North Central, east:								
Motor trucks, 1918..	9.3	4.8	64	90	11	9
Wagons, 1918.....	6.3	2.0	41	54	29	26
Wagons, 1906.....	7.0	1.8	40	48	16	18
North Central, west:								
Motor trucks, 1918..	10.1	3.8	54	84	18	14
Wagons, 1918.....	7.9	1.5	42	57	33	29
Wagons, 1906.....	8.7	1.4	39	52	17	16
South Central, east:								
Motor trucks, 1918..	12.9	3.2	58	86	7.6	12	10	13
Wagons, 1918.....	10.4	1.0	26	38	3.2	45	36	52
Wagons, 1906.....	11.1	1.0	29	37	3.0	24	23	31
South Central, west:								
Motor trucks, 1918..	13.0	2.9	57	72	6.7	17	15	20
Wagons, 1918.....	10.9	1.0	26	46	3.8	49	32	47
Wagons, 1906.....	12.6	.9	29	38	3.8	22	21	26
Rocky Mountain:								
Motor trucks, 1918..	21.0	1.2	48	70	36	29
Wagons, 1918.....	20.2	.4	46	66	52	42
Wagons, 1906.....	16.8	.7	49	60	16	20
Pacific:								
Motor trucks, 1918..	12.3	2.9	74	105	20	17
Wagons, 1918.....	11.2	1.4	71	67	23	22
Wagons, 1906.....	11.5	1.1	45	76	28	21

¹ Not shelled.² The geographic divisions are—New England: Maine, New Hampshire, Vermont, Massachusetts, Rhode Island, Connecticut; Middle Atlantic: New York, New Jersey, Pennsylvania; South Atlantic: Delaware, Maryland, Virginia, West Virginia, North Carolina, South Carolina, Georgia, Florida; North Central east of the Mississippi River: Ohio, Indiana, Illinois, Michigan, Wisconsin; North Central west of the Mississippi River: Minnesota, Iowa, Missouri, North Dakota, South Dakota, Nebraska, Kansas; South Central east of the Mississippi River: Kentucky, Tennessee, Alabama, Mississippi; South Central west of the Mississippi River: Louisiana, Texas, Oklahoma, Arkansas; Rocky Mountain: Montana, Wyoming, Colorado, New Mexico, Arizona, Utah, Nevada; Idaho; Pacific: Washington, Oregon, California.

RURAL AND AGRICULTURAL POPULATION.

TABLE 317.—Rural and agricultural population in various countries.

Country.	Rural population.			Population dependent upon agriculture.		
	Year.	Number.	Per cent of total population.	Year.	Number.	Per cent of total population.
United States.....	1910	49,348,883	53.7			
Austria-Hungary:						
Austria.....				1900	13,447,362	51.4
Hungary.....				1900	13,061,118	67.8
Total Austria-Hungary.....				1900	26,508,480	58.4
Belgium.....	1910	1,654,277	22.3			
British India.....				1901	191,691,731	65.1
Bulgaria.....				1905	3,089,301	76.6
Denmark.....	1911	1,647,350	59.7	1911	1,023,962	37.1
Finland.....				1900	1,555,357	57.3
France.....	1906	22,715,011	57.9	1891	17,435,888	45.7
Germany.....				1907	17,089,496	27.7
Norway.....				1900	854,787	38.5
Portugal.....	1890	3,458,996	68.5	1900	3,367,199	62.1
Roumania.....	1900	4,836,904	81.2			
Russia:						
Caucasus.....				1897	7,266,428	78.2
Central Asia.....				1897	6,361,466	82.1
Poland.....				1897	5,302,850	56.4
Russia proper.....				1897	69,470,360	74.3
Siberia.....				1897	4,448,456	77.2
Total Russia.....				1897	92,849,560	73.9
Serbia.....				1900	2,097,988	84.2
Sweden.....				1900	2,344,612	45.6
Switzerland.....	1900	1,047,795	31.6	1900	1,067,905	32.2
United Kingdom:						
England and Wales.....	1911	7,907,556	21.9			

TABLE 318.—Number of persons engaged in agriculture in various countries.

Country.	Year.	Males.		Females.		Total persons engaged in agriculture.	
		Number.	Per cent of males in all occupations.	Number.	Per cent of females in all occupations.	Number.	Per cent of persons in all occupations.
United States.....	1910	10,582,039	35.2	1,806,584	22.4	12,388,623	32.5
Algeria.....	1881	636,078	74.8	91,602	53.7	727,680	71.3
Argentina.....	1895	318,149	28.0	67,174	13.4	385,323	23.6
Australia.....	1901	377,626	29.5	39,029	11.1	416,655	25.6
Austria-Hungary.....	1900	8,185,250	58.5	5,935,805	70.3	14,121,055	63.0
Belgium.....	1900	533,665	23.6	163,707	17.6	697,372	21.9
Bolivia.....	1900					564,009	43.5
British India.....	1901	63,026,365	67.3	27,867,210	66.5	90,893,575	67.1
British North Borneo.....	1901					32,892	64.2
Bulgaria.....	1905	895,206	73.3	837,406	94.9	1,732,612	82.4
Canada.....	1901	707,997	45.4	8,940	3.7	716,937	39.9
Ceylon.....	1901	745,074	65.0	318,551	65.4	1,063,625	65.1
Chile.....	1907	448,546	50.3	21,877	6.2	470,423	37.7
Cuba.....	1907	364,821	52.2	3,110	4.2	367,921	47.6
Cyprus.....	1901	33,611	62.8	2,757	20.8	36,368	54.5
Denmark.....	1911	386,016	45.7	110,169	28.5	496,185	40.3
Egypt.....	1907	2,258,005	67.2	57,144	33.3	2,315,149	65.6
Federated Malay States.....	1901	115,027	28.2	52,324	82.7	167,351	35.5
Finland.....	1900	321,538	51.4	102,008	39.6	423,546	48.0
Formosa.....	1905	763,456	70.6	263,664	82.4	1,027,120	73.3
France.....	1906	5,452,392	41.9	3,324,661	43.2	8,777,053	42.4
Germany.....	1907	5,146,723	27.7	4,585,749	48.3	9,732,472	34.6
Greece.....	1907	321,120	47.3	6,972	12.2	328,092	44.6
Grenada.....	1901	8,816	57.1	7,722	49.7	16,538	53.4
Italy.....	1901	6,370,277	57.9	3,196,063	60.5	9,566,340	58.8
Jamaica.....	1911					271,493	66.1
Malta and Gozo.....	1901	10,235	13.3	3,613	15.8	13,848	13.9
Mauritius.....	1901	72,493	57.1	5,989	38.0	78,482	55.0
Netherlands.....	1899	490,694	32.9	79,584	18.4	570,278	29.6
New Zealand.....	1911	103,644	28.5	7,472	8.3	111,116	24.5
Norway.....	1910					307,528	33.4
Philippine Islands.....	1903	1,163,777	57.8	90,286	8.8	1,254,063	41.3
Porto Rico.....	1899	196,893	73.3	1,868	3.9	198,761	62.8
Portugal.....	1900	1,127,268	65.3	380,293	52.0	1,507,561	61.4
Russia:							
In Europe.....	1897	13,808,505	59.6	1,974,164	38.0	15,782,669	55.6
In Asia.....	1897	2,092,965	69.2	105,137	30.5	2,198,102	65.3
Total.....	1897	15,901,470	60.7	2,079,301	37.5	17,980,771	56.7
St. Lucia.....	1901					15,796	54.1
Serbia.....	1900	311,700	65.5	13,524	50.5	325,224	64.7
Sierra Leone.....	1901	8,705	28.7	4,544	21.7	13,249	25.9
Spain.....	1900	3,741,730	58.1	775,270	51.8	4,517,000	56.9
Sweden.....	1900	761,016	52.4	333,264	53.8	1,094,280	52.8
Switzerland.....	1900	392,971	37.1	80,326	16.1	473,297	30.4
Trinidad and Tobago.....	1901	51,744	54.7	25,765	39.3	77,509	48.4
Union of South Africa.....	1904	863,223	56.3	847,057	77.5	1,710,280	65.1
United Kingdom.....	1901	2,109,812	16.3	152,642	2.9	2,262,454	12.4

AGRICULTURAL LAND.

TABLE 319.—Total area and agricultural land in various countries.

[As classified and reported by the International Institute of Agriculture.]

Country.	Year.	Total area.	Productive land. ¹		Cultivated land. ²	
			Amount.	Per cent of total area.	Amount.	Per cent of total area.
NORTH AMERICA.						
United States.....	1910	<i>Acres.</i> 1,903,269,000	<i>Acres.</i> 878,789,000	<i>Per cent.</i> 46.2	<i>Acres.</i> 293,794,000	<i>Per cent.</i> 15.4
Canada.....	1901	2,397,082,000	63,420,000	2.6	19,880,000	.8
Costa Rica.....	1909-10	13,343,000	3,090,000	23.2	442,000	3.3
Cuba.....	1899	28,299,000	8,717,000	30.8	778,000	2.7
SOUTH AMERICA.						
Argentina.....	1909-10	729,575,000	537,805,000	73.7	44,446,000	6.1
Chile ³	1910-11	187,145,000	15,144,000	8.1	2,557,000	1.4
Uruguay.....	1908	46,189,000	40,875,000	88.5	1,962,000	4.2
EUROPE.						
Austria-Hungary:						
Austria.....	1911	74,132,000	69,939,000	94.3	26,272,000	35.4
Hungary.....	1910	80,272,000	77,225,000	96.2	35,178,000	43.8
Total Austria-Hungary.....		154,404,000	147,164,000	95.3	61,450,000	39.8
Belgium.....	1895	7,278,000	6,443,000	88.5	3,582,000	49.2
Bulgaria.....	1910	23,807,000	18,959,000	79.6	8,574,000	36.0
Denmark.....	1907	9,629,000	9,078,000	94.3	6,376,000	66.2
Finland.....	1901	82,113,000	3,875,000	4.7
France.....	1910	130,854,000	123,642,000	94.5	59,124,000	45.2
Germany.....	1900	133,594,000	126,401,000	94.6	63,689,000	47.7
Italy.....	1911	70,839,000	65,184,000	92.0	33,815,000	47.7
Luxemburg.....	1911	639,000	616,000	96.4	300,000	46.9
Netherlands.....	1911	8,057,000	7,258,000	90.1	2,210,000	27.4
Norway.....	1907	79,810,000	22,942,000	28.7	1,830,000	2.3
Portugal.....	1912	22,018,000	17,281,000	78.5	5,777,000	26.2
Roumania.....	1905	32,167,000	24,645,000	76.6	14,829,000	46.1
Russia, European.....	1911	1,278,203,000	698,902,000	54.7	245,755,000	19.2
Serbia.....	1897	11,936,000	6,246,000	52.3	2,534,000	21.2
Spain.....	1908-1911	124,666,000	112,665,000	90.4	41,264,000	33.1
Sweden.....	1911	110,667,000	65,196,000	58.9	9,144,000	8.3
Switzerland ⁴	1905	10,211,000	7,635,000	74.8	605,000	5.9
United Kingdom:						
Great Britain.....	1911	56,802,000	47,737,000	84.0	14,587,000	25.7
Ireland.....	1911	20,350,000	18,789,000	92.3	3,275,000	16.1
Total United Kingdom.....		77,152,000	66,526,000	86.2	17,862,000	23.2
ASIA.						
British India.....	1910-11	615,655,000	465,706,000	75.6	264,858,000	43.0
Formosa.....	1911	8,858,000	1,972,000	22.3	1,884,000	21.3
Japan.....	1911	94,495,000	74,180,000	78.5	17,639,000	18.7
Russia, Asiatic.....	1911	4,028,001,000	715,838,000	17.8	33,860,000	.8
AFRICA.						
Algeria.....	1910	124,976,000	50,846,000	40.7	11,434,000	9.1
Egypt.....	1912	222,390,000	5,486,000	2.5	5,457,000	2.5
Tunis.....	1912	30,888,000	22,239,000	72.0	6,919,000	22.4
Union of South Africa.....	1909-10	302,827,000	3,569,000	1.2	3,385,000	1.1
OCEANIA.						
Australia.....	1910-11	1,903,664,000	119,942,000	6.3	14,987,000	.8
New Zealand.....	1910	66,469,000	57,310,000	86.2	6,955,000	10.5
Total, 36 countries.....		15,071,209,000	4,591,691,000	30.5	1,313,832,000	8.7

¹ Includes, besides cultivated land, also natural meadows and pastures, forests, wood lots, and lands devoted to cultivated trees and shrubs.

² Includes fallow lands; also artificial grasslands.

³ The figure for "productive land" in Chile excludes marshes, heaths, and productive but uncared-for lands.

⁴ The figure for "cultivated land" in Switzerland excludes artificial meadows and pastures.

NATIONAL FORESTS.

TABLE 320.—National forests: Timber disposed of, quantity, price, and number of users, revenue under specified heads, and details of grazing privileges, years ended June 30, 1913 to 1918.

[Reported by the Forest Service.]

Item.	Year ended June 30—					
	1913	1914	1915	1916	1917	1918
Free timber given:						
Number of users.....	38,264	39,466	40,040	42,055	41,427	38,073
Timber cut.....M ft..	121,750	120,575	123,259	119,483	113,073	98,376
Value.....dolls..	191,825	183,223	206,597	184,715	149,802	128,866
Timber sales:						
Number.....	6,182	8,303	10,905	10,840	11,608	13,037
Quantity.....M ft..	2,137,311	1,540,084	1,093,589	906,906	2,008,087	1,453,299
Price per thousand board feet (average).....dolls..	2.01	2.30	2.44	1.98	1.85	2.28
Grazing:						
Number of permits.....	27,466	28,945	30,610	33,328	36,638	39,113
Kinds of stock—						
Cattle.....No..	1,455,922	1,508,639	1,627,321	1,758,764	1,953,198	2,137,854
Goats.....No..	76,898	58,616	51,409	43,268	49,939	57,968
Hogs.....No..	3,277	3,381	2,792	2,968	2,306	3,371
Horses.....No..	97,919	108,241	96,933	98,903	98,880	102,156
Sheep.....No..	7,790,953	7,560,186	7,232,276	7,843,205	7,586,034	8,454,240
Total.....No..	9,424,969	9,239,063	9,010,731	9,747,108	9,690,357	10,755,589
Special use and water-power permits.....No..	5,245	5,089	5,657	5,251	6,087	5,819
Revenue:						
From—						
Timber sales.....dolls..	1,282,647	1,243,195	1,211,985	1,367,111	1,595,873	1,519,867
Timber settlements, ¹ dollars.....	36,105	39,927	3,181	2,299	17,102	99,502
Timber trespass, dollars.....	17,558	12,981	7,284	37,712	18,870	2,330
Turpentine sales, ² dollars.....		15,372	8,915	14,402	8,156	8,334
Fire trespass.....dolls..	5,028	7,950	661	5,471	52,514	3,618
Occupancy trespass.....						1,207
Special uses.....dolls..	67,278	68,773	78,691	85,235	108,329	119,979
Grazing fees.....dolls..	1,001,156	997,583	1,130,175	1,202,405	1,544,714	³ 1,702,585
Grazing trespass, dollars.....	6,583	4,765	5,818	7,810	5,081	23,532
Water power...dolls..	51,235	47,164	89,104	101,096	106,389	93,976
Total revenue dollars.....	2,467,590	2,437,710	⁴ 2,535,814	2,823,541	3,457,028	3,574,930

¹ Includes timber taken in the exercise of permits for rights of way, development of power, etc.² Prior to 1914 receipts from sale of turpentine were included with timber sales.³ Includes \$296 from sale of live stock.⁴ Refunds during year, \$54,575.

TABLE 321.—Area of National forest lands, June 30, 1918.

[Reported by the Forest Service.]

State and forest.	Net area.	State and forest.	Net area.
Alabama:	<i>*Acres.</i>	Idaho:	<i>Acres.</i>
Alabama.....	27, 745	Boise.....	1, 058, 941
Alaska:		Cache 1.....	493, 430
Chugach.....	5, 417, 602	Caribou 1.....	681, 475
Tongass.....	15, 450, 657	Challis.....	1, 258, 912
Total.....	20, 868, 259	Clearwater.....	785, 103
Arizona:		Coeur d'Alene.....	662, 592
Apache.....	1, 182, 163	Idaho.....	1, 170, 801
Coconino.....	1, 651, 422	Kaniksu 1.....	197, 476
Coronado 1.....	1, 306, 164	Lemhi.....	1, 095, 924
Crook.....	877, 06	Minidoka 1.....	509, 226
Dixie 1.....	17, 680	Nez Perce.....	1, 624, 562
Kaibab.....	1, 072, 339	Payette.....	831, 926
Prescott.....	1, 433, 164	Pend Oreille.....	675, 536
Sitgreaves.....	657, 293	St. Joe.....	626, 421
Tonto.....	1, 993, 437	Salmon.....	1, 621, 250
Tusayan.....	1, 611, 773	Sawtooth.....	1, 160, 101
Total.....	11, 795, 541	Selway.....	1, 693, 711
Arkansas:		Starghee 1.....	977, 181
Arkansas.....	626, 746	Weiser.....	562, 362
Ozark.....	291, 840	Total.....	17, 686, 930
Total.....	918, 586	Maine:	
California:		White Mountain 1.....	24, 994
Angeles.....	820, 199	Michigan:	
California.....	807, 444	Michigan.....	89, 466
Cleveland.....	547, 951	Minnesota:	
Crater 1.....	47, 097	Minnesota.....	190, 602
Eldorado 1.....	550, 352	Superior.....	853, 477
Inyo 1.....	1, 272, 260	Total.....	1, 044, 079
Klamath 1.....	1, 489, 745	Montana:	
Lassen.....	937, 037	Absaroka.....	840, 820
Modoc.....	1, 138, 068	Beartooth.....	662, 534
Mono 1.....	785, 541	Beaverhead.....	1, 335, 483
Monterey.....	319, 543	Bitterroot.....	1, 047, 012
Plumas.....	1, 144, 835	Blackfoot.....	904, 587
Santa Barbara.....	1, 688, 609	Cabinet.....	837, 250
Sequoia.....	1, 879, 815	Custer.....	428, 601
Shasta.....	803, 448	Deerlodge.....	831, 919
Sierra.....	1, 488, 655	Flathead.....	1, 756, 255
Siskiyou 1.....	348, 927	Gallatin.....	504, 695
Stanislaus.....	810, 559	Helena.....	687, 335
Tahoe 1.....	540, 845	Jefferson.....	1, 038, 560
Trinity.....	1, 426, 112	Kootenai.....	1, 334, 836
Total.....	18, 895, 042	Lewis and Clark.....	811, 150
Colorado:		Lolo.....	850, 677
Arapahoe.....	634, 775	Madison.....	956, 776
Battlement.....	650, 596	Missoula.....	1, 031, 449
Cochetopa.....	905, 813	Sioux 1.....	96, 199
Colorado.....	847, 328	Total.....	16, 016, 138
Durango.....	616, 630	Nebraska:	
Gunnison.....	906, 491	Nebraska.....	205, 944
Hayden 1.....	65, 598	Nevada:	
Holy Cross.....	576, 113	Dixie 1.....	282, 543
La Sal 1.....	27, 444	Eldorado 1.....	400
Leadville.....	930, 585	Humboldt.....	1, 298, 115
Montezuma.....	696, 044	Inyo 1.....	72, 817
Pike.....	1, 079, 150	Mono 1.....	464, 316
Rio Grande.....	1, 136, 539	Nevada.....	1, 220, 781
Routt.....	832, 152	Tahoe 1.....	14, 853
San Isabel.....	598, 912	Tolyabe.....	1, 906, 856
San Juan.....	617, 498	Total.....	5, 260, 681
Sopris.....	596, 508	New Hampshire:	
Uncompahgre.....	789, 959	White Mountain 1.....	275, 969
White River.....	846, 809	New Mexico:	
Total.....	13, 354, 944	Carson.....	859, 149
Florida:		Coronado 1.....	1, 371, 544
Florida.....	308, 268	Datil.....	126, 318

1 For total area, see Table 321A, "National Forests extending into two States."

TABLE 321.—Area of National forest lands, June 30, 1918—Continued.

State and forest.	Net area.	State and forest.	Net area.
New Mexico—Continued.	<i>Acres.</i>	Utah—Continued.	<i>Acres.</i>
Gila.....	2, 668, 675	Powell.....	688, 491
Lincoln.....	1, 466, 411	Sevier.....	724, 606
Manzano.....	1, 140, 762	Uinta.....	987, 917
Santa Fe.....	701, 078	Wasatch.....	604, 518
Total.....	8, 333, 937	Total.....	7, 403, 515
North Carolina:		Virginia:	
Pisgah.....	77, 045	Natural Bridge.....	73, 597
		Shenandoah ¹	87, 159
Oklahoma:		Total.....	160, 756
Wichita.....	61, 480		
Oregon:		Washington:	
Cascade.....	1, 021, 633	Chelan.....	677, 424
Crater ¹	798, 588	Columbia.....	785, 535
Deschutes.....	1, 287, 266	Colville.....	754, 739
Fremont.....	856, 369	Kaniksu ¹	257, 763
Klamath ¹	4, 401	Okanogan.....	1, 487, 089
Malheur.....	1, 057, 682	Olympic.....	1, 534, 583
Minam.....	430, 694	Ranier.....	1, 315, 898
Ochoco.....	716, 604	Snoqualmie.....	697, 855
Oregon.....	1, 032, 936	Washington.....	1, 453, 365
Santiam.....	607, 097	Wenaha ¹	313, 434
Siskiyou ¹	998, 090	Wenatchee.....	665, 276
Siuslaw.....	543, 383	Total.....	9, 942, 961
Umatilla.....	485, 786		
Umpqua.....	1, 011, 022	West Virginia:	
Wallowa.....	957, 579	Shenandoah ¹	13, 318
Wenaha ¹	425, 504		
Whitman.....	882, 496	Wyoming:	
Total.....	13, 117, 130	Ashley ¹	5, 987
		Bighorn.....	1, 120, 102
Porto Rico:		Black Hills ¹	144, 759
Luquillo.....	12, 443	Bridger.....	712, 454
		Caribou ¹	6, 330
South Dakota:		Hayden ¹	324, 696
Black Hills ¹	480, 096	Medicine Bow.....	473, 762
Harney.....	546, 181	Shoshone.....	1, 576, 733
Sioux ¹	75, 209	Targhee ¹	335, 481
Total.....	1, 101, 486	Teton.....	1, 924, 968
		Washakie.....	852, 653
Utah:		Wyoming.....	900, 020
Ashley ¹	975, 058	Total.....	8, 377, 945
Cache ¹	268, 501	Total, National Forests.....	155, 374, 602
Dixie ¹	427, 029		
Fillmore.....	699, 579	White Mountain and Appalachian	
Fishlake.....	651, 377	area.....	552, 966
La Sal ¹	519, 384		
Manti.....	784, 932	Grand total.....	155, 927, 568
Minidoka ¹	72, 123		

¹ For total area, see "National Forests extending into two or more States.

TABLE 321A.—National forests extending into two or more States.

Forest.	States.	Net area.
		<i>Acres.</i>
Coronado.....	Arizona-New Mexico.....	1,432,482
Dixie.....	Arizona-Nevada-Utah.....	727,252
Crater.....	California-Oregon.....	845,685
Eldorado.....	California-Nevada.....	550,752
Inyo.....	do.....	1,345,077
Klamath.....	California-Oregon.....	1,494,146
Mono.....	California-Nevada.....	1,249,857
Siskiyou.....	California-Oregon.....	1,347,017
Tahoe.....	California-Nevada.....	555,698
Hayden.....	Colorado-Wyoming.....	390,294
La Sal.....	Colorado-Utah.....	546,828
Cache.....	Idaho-Utah.....	761,931
Caribou.....	Idaho-Wyoming.....	687,805
Kaniksu.....	Idaho-Washington.....	455,239
Minidoka.....	Idaho-Utah.....	581,349
Targhee.....	Idaho-Wyoming.....	1,312,662
Sioux.....	Montana-South Dakota.....	171,408
Wenaha.....	Oregon-Washington.....	738,938
Black Hills.....	South Dakota-Wyoming.....	624,855
Ashley.....	Utah-Wyoming.....	981,045
White Mountain.....	Maine-New Hampshire.....	300,993
Shenandoah.....	Virginia-West Virginia.....	100,477

TABLE 322.—Grazing allowances for National forests, 1918.

[Reported by the Forest Service. The symbols (+) or (-) indicate, respectively, that there was an increase or decrease in 1918 compared with 1917. The figures themselves refer to actual numbers of stock authorized in 1918.]

Forest.	Number of stock authorized.			Yearlong rates (cents).			
	Cattle and horses.	Swine.	Sheep and goats.	Cattle.	Horses.	Swine.	Sheep and goats.
District 1:							
Absaroka.....	+ 7,255		- 92,100	68	85	51	17
Beartooth.....	+ 5,200	300	- 47,000				
Beaverhead.....	+ 25,250		+ 126,000				
Bitterroot.....	+ 4,500		+ 70,000				
Blackfeet.....	- 1,500		+ 25,000	60	75	45	15
Cabinet.....	2,400		25,000	68	85	51	17
Clearwater.....	2,400		25,000	60	75	45	15
Coeur d'Alene.....	+ 1,000		- 20,000	68	85	51	17
Custer.....	+ 21,500		- 6,000				
Deerlodge.....	+ 16,900		61,600				
Flathead.....	3,650		5,000	60	75	45	15
Gallatin.....	+ 9,030		- 59,000	68	85	51	17
Helena.....	+ 20,400		- 72,500				
Jefferson.....	+ 24,250		- 129,700				
Kankisu.....	1,000		+ 12,000	60	75	45	15
Kootenai.....	+ 2,850		+ 30,000				
Lewis & Clark.....	+ 10,400		+ 43,500	68	85	51	17
Lolo.....	500		35,000				
Madison ¹	+ 31,000		+ 141,800	75	94	56.25	18.75
Missoula.....	+ 11,650		- 10,500	68	85	51	17
Nezperce ²	- 15,100		+ 100,000				
Pend Oreille ²	- 1,400		- 31,000	60	75	45	15
Selway.....	5,250		+ 25,000				
Sioux.....	+ 8,400		2,800	68	85	51	17
St. Joe.....	400		- 32,000	60	75	45	15
	+ 233,185	300	1,227,500				
District 2:							
Arapaho.....	+ 13,650		+ 27,500	68	85	51	17
Battlement.....	48,350		+ 10,000				
Bighorn.....	+ 47,485		+ 120,450	75	94	56.25	18.75
Black Hills.....	+ 27,400	+ 2,500		68	85	51	17
Cochetopa.....	+ 19,050		+ 75,700				
Colorado.....	+ 28,750		+ 12,600				

¹ Term applications previously approved effective until expiration of period.

² Term applications authorized.

TABLE 322.—Grazing allowances for National forests, 1918—Continued.

Forest.	Number of stock authorized.			Yearlong rates (cents).			
	Cattle and horses.	Swine.	Sheep and goats.	Cattle.	Horses.	Swine.	Sheep and goats.
District 2—Continued.							
Durango.....	+ 12, 650		- 95, 700				
Gunnison.....	+ 35, 425		+ 57, 200				
Harney.....	+ 12, 100						
Hayden.....	+ 8, 075		120, 000				
Holy Cross.....	+ 14, 970		- 37, 900				
Leadville.....	+ 15, 000		+105, 000				
Medicine Bow.....	+ 10, 300		+ 57, 100				
Michigan.....	+ 1, 250		+ 3, 300				
Minnesota.....	2, 000						
Montezuma.....	+ 35, 500		+ 51, 500				
Nebraska ¹	+ 14, 000			90	113	67. 5	22. 5
Pike.....	+ 19, 950		+ 21, 000	68	85	51	17
Rio Grande.....	+ 25, 320		+284, 000				
Routt.....	+ 33, 200		+119, 900				
San Isabel.....	+ 16, 000	+ 50	+ 18, 950				
San Juan.....	+ 13, 320	+1, 000	+ 102, 900				
Shoshone ¹	+ 13, 835		+ 73, 300				
Sopris.....	+ 14, 000		+ 53, 500				
Uncompahgre.....	+ 32, 750		+ 60, 500				
Washakie ¹	+ 12, 500		+ 44, 000				
White River.....	40, 425		+ 38, 000				
	+567, 275	+3, 550	+1, 590, 000				
District 3:							
Apache.....	+ 45, 200	+ 180	- 61, 500	60	75	45	15
Carson.....	+ 10, 800	+ 200	- 155, 350				
Coconino ¹	45, 000	250	94, 000				
Coronado.....	+ 45, 100	+ 200	+ 7, 200				
Crook.....	+ 29, 760	100	1, 350				
Datil.....	+ 53, 600	225	+ 147, 000				
Gila.....	59, 000	+ 440	+ 13, 100				
Lincoln.....	+ 30, 000	+1, 200	+ 23, 100				
Manzano.....	+ 9, 800		+ 85, 000				
Prescott.....	+ 61, 000	+ 100	+ 68, 500				
Santa Fe.....	+ 19, 000	500	+ 130, 000				
Sitgreaves.....	+ 9, 900		- 68, 500				
Tonto.....	+ 68, 000	+ 500	100				
Tusayan ¹	+ 32, 900	+ 165	+ 79, 200				
	+519, 060	+4, 055	+ 933, 900				
District 4:							
Ashley.....	+ 11, 400		+ 106, 000	75	94	56. 25	18. 75
Boise ¹	+ 4, 800	100	148, 000	75	94	56. 25	18. 75
Bridger.....	+ 18, 850		+ 74, 200	68	85	51	17
Cache.....	- 32, 500		136, 000				
Caribou.....	+ 21, 500		- 281, 000				
Challis.....	+ 9, 100		+ 97, 000				
Dixie.....	8, 800	400	1, 000	60	75	45	15
Fillmore.....	+ 20, 600	500	- 36, 000	75	94	56. 25	18. 75
Fishlake.....	+ 18, 500		- 68, 000				
Humboldt.....	+ 59, 600		+ 364, 000	68	85	51	17
Idaho ¹	2, 650		- 98, 000				
Kaibab.....	+ 12, 700		5, 000	60	75	45	15
La Sal.....	+ 28, 550	100	39, 000	68	85	51	17
Lemhi.....	+ 18, 300		78, 000	68	85	51	17
Manti.....	27, 237		+ 152, 100	75	94	56. 25	18. 75
Minidoka.....	- 25, 400		77, 000	68	85	51	17
Nevada.....	+ 5, 700		- 50, 500				
Payette ¹	+ 7, 950		88, 000	75	94	56. 25	18. 75
Powell.....	+ 13, 400		+ 75, 000	68	85	51	17
Salmon.....	+ 18, 000		125, 000				
Sawtooth ¹	+ 10, 500		- 300, 000	75	94	56. 25	18. 75
Sevier.....	11, 500	- 50	113, 000	68	85	51	17
Targhee ¹	+ 34, 700		+ 234, 000				
Teton.....	17, 200		20, 000				
Toiyabe.....	- 22, 100		+ 24, 000				
Uinta ¹	+ 35, 900		- 195, 000	75	94	56. 25	18. 75
Wasatch.....	+ 13, 600		60, 100				
Weiser.....	+ 13, 750	- 500	- 65, 000	75	94	56. 25	18. 75
Wyoming ²	11, 500		197, 000	68	85	51	17
	+536, 287	-1, 650	3, 306, 900				

¹ Term applications previously approved effective until expiration of period.² Term applications authorized.

TABLE 322.—Grazing allowances for National forests, 1918—Continued.

Forest.	Number of stock authorized.			Yearlong rates (cents).			
	Cattle and horses.	Swine.	Sheep and goats.	Cattle.	Horses.	Swine.	Sheep and goats.
District 5:							
Angeles 1.....	4,100			75	94	56.25	18.75
California.....	+ 9,500	- 300	51,300				
Cleveland.....	- 1,800		1,300				
Eldorado.....	+ 11,725		21,200	90	113	67.5	22.5
Inyo.....	+ 7,600		45,560				
Klamath.....	- 10,000	+ 800	32,000	75	94	56.25	18.75
Lassen.....	+ 13,550	300	42,000	80	100	60	20
Modoc.....	+ 45,700		62,600	75	94	56.25	18.75
Mono.....	+ 5,800		79,200	90	113	67.5	22.5
Monterey.....	1,300	400	2,000	80	100	60	20
Plumas.....	+ 15,500		87,775	85	106	63.75	21.25
Santa Barbara.....	+ 9,825	300	5,000	80	100	60	20
Sequoia.....	- 29,900	- 600	19,800	90	113	67.5	22.5
Shasta.....	+ 11,700	- 200	32,600	75	94	56.25	18.75
Sierra.....	+ 21,200	- 400	85,300	90	113	67.5	22.5
Stanislaus.....	+ 20,625	- 50	10,850				
Tahoe.....	+ 9,050	- 50	55,000				
Trinity.....	13,050	415	24,100	70	88	52.5	17.5
	+241,925	-3,815	+ 658,585				
District 6:							
Cascade.....	+ 1,100		27,000	80	100	60	20
Chelan 1.....	- 550		35,000	75	94	56.25	18.75
Columbia 1.....	- 1,300		15,600	80	100	60	20
Colville.....	6,000		60,000	75	94	56.25	18.75
Crater.....	+ 15,100		14,400				
Deschutes.....	+ 7,500		30,500				
Fremont.....	15,000		95,000				
Malheur.....	25,000		121,000				
Minam.....	+ 15,400		79,000				
Ochoco.....	+ 16,700		84,500				
Okanogan 1.....	+ 15,500		100,000				
Olympic.....	2,500						
Oregon.....	+ 3,600		23,000	80	100	60	20
Rainier.....	+ 7,900		59,000				
Santiam.....	+ 350		20,000				
Siskiyou.....	4,100	1,000	4,200	75	94	56.25	18.75
Siuslaw.....	+ 1,500		7,000				
Snoqualmie.....			7,200	80	100	60	20
Umatilla.....	+ 10,200		60,000	75	94	56.25	18.75
Umpqua.....	1,400		10,000	80	100	60	20
Wallowa.....	+ 27,000		75,000	75	94	56.25	18.75
Washington.....	250		5,000	80	100	60	20
Wenaha.....	+ 13,100		102,700	75	94	56.25	18.75
Wenatchee.....	950		66,000	80	100	60	20
Whitman.....	+ 10,950		105,700	75	94	56.25	18.75
	+202,950	-1,000	+1,206,800				
District 7:							
Arkansas.....	+ 30,000	22,000	2,000	60	75	45	15
Florida.....	6,000	3,000	7,000				
Ozark.....	- 7,890	9,865	1,972				
Wichita.....	+ 4,710			125	156	93.75	31.25
	+ 48,600	-34,865	+ 10,972				
Purchase areas:							
Alabama.....	120			150	200	90	45
Cherokee.....	+ 2,300	+ 700	500	150	200	90	45
Georgia.....	+ 1,500	+ 500	500	125	170	78	39
Monongahela.....	400	40	100	150	200	90	45
Natural Bridge.....	400						
Pisgah.....	+ 1,000	100	550				
Savannah.....	710	560	430				
Shenandoah.....	- 2,580	100	750				
Unaka.....	500	400	200				
White Mountain.....	110						
White Top.....	500	50	150				
	+ 10,120	+ 2,450	+ 3,180				
Totals, 1913.....	1,852,999	59,535	8,521,308				
Totals, 1914.....	1,891,119	65,645	8,867,906				
Totals, 1915.....	1,983,775	64,040	8,747,025				
Totals, 1916.....	2,008,675	58,990	8,597,689				
Totals, 1917.....	2,120,145	54,680	8,400,155				
Totals, 1918.....	2,359,402	51,685	8,937,837				
Increase or decrease in 1918 over 1917.....	+239,257	- 2,995	+ 537,682				

¹ Term applications previously approved effective until expiration of period.

PASTURE LAND.

TABLE 323.—Pasture land and its carrying capacity.

The figures on acreage of pasture land on farms presented below were obtained from the agricultural schedules collected by the Bureau of the Census in 1910. The tabulation was made by the Office of Farm Management of the Department of Agriculture, in Bulletin 626 of the Department of Agriculture. Figures relating to number of months in year the land is pastured and the potential carrying capacity, expressed in terms of head of cattle, are estimates, based upon estimates of county reporters of the Bureau of Crop Estimates. The value of feed obtained from pasture has not in the past been included in yearly statistics of crop values, although it aggregates over \$1,000,000,000.

State.	Pasture land acreage, 1910.				Months in year pastured.				Carrying capacity, cattle per 100 acres.			
	Total.	Improved.	Woodland.	Other.	Total.	Improved.	Woodland.	Other.	Total.	Improved.	Woodland.	Other.
Me.....	1,935,123	323,965	1,007,776	603,382	5.5	5.9	5.5	5.5	20	31	16	16
N. H.....	1,211,772	79,949	782,227	349,596	5.7	5.8	5.7	5.7	12	18	8	11
Vt.....	2,274,161	376,328	951,391	946,442	6.3	6.3	6.2	6.5	20	30	19	15
Mass.....	926,758	150,392	475,970	300,396	6.0	6.1	5.9	20	25	20
R. I.....	128,704	39,734	59,876	29,094	9.0	9.0	9.0	9.0	20	25	10	25
Conn.....	816,153	173,030	377,051	266,072	6.1	6.1	5.5	6.2	26	33	25	23
N. Y.....	7,501,640	3,098,982	2,417,633	1,985,025	5.9	6.0	5.9	5.9	32	40	35	36
N. J.....	433,188	225,770	101,705	105,713	6.5	6.4	6.6	6.5	35	37	25	35
Pa.....	4,356,126	1,798,923	1,612,309	938,894	5.7	5.7	5.4	5.8	30	42	28	35
Del.....	103,679	67,463	15,475	20,741	6.0	6.0	6.0	6.0	35	50	25	32
Md.....	860,450	497,133	234,054	129,263	6.7	6.6	6.6	7.1	35	50	35	28
Va.....	4,428,410	2,385,360	1,544,914	489,136	6.2	6.6	6.3	6.0	28	38	30	26
W. Va.....	3,484,060	2,262,876	714,584	516,600	6.5	6.9	6.5	6.3	28	35	25	22
N. C.....	2,056,413	567,532	1,194,679	294,202	6.6	6.9	6.5	6.5	27	43	25	25
S. C.....	1,286,912	154,452	953,086	179,374	7.2	7.7	7.2	6.6	30	45	25	20
Ga.....	2,537,399	313,305	1,956,233	267,861	7.1	7.3	7.1	6.7	33	52	27	30
Fla.....	578,742	51,034	410,765	116,943	8.7	7.8	10.8	9.2	35	45	21	35
Ohio.....	7,973,822	4,536,624	2,284,829	1,152,369	6.7	6.6	6.7	6.5	39	50	33	38
Ind.....	5,686,469	2,551,771	2,418,642	716,056	6.5	6.5	6.6	6.3	52	65	45	42
Ill.....	7,636,546	4,081,506	2,550,782	1,004,258	6.6	6.6	6.5	6.1	48	60	43	40
Mich.....	5,333,751	1,362,743	2,424,930	1,546,078	6.2	6.1	6.2	6.2	38	40	27	38
Wis.....	7,775,602	1,699,127	4,171,617	1,904,858	6.0	6.2	5.9	5.9	47	60	30	33
Minn.....	6,591,439	2,006,150	2,905,559	1,679,730	5.7	6.0	5.6	5.6	40	52	32	35
Iowa.....	10,655,616	6,271,197	2,630,007	1,754,412	5.9	6.1	6.1	5.8	51	60	49	48
Mo.....	10,781,515	5,534,034	4,384,280	863,201	6.7	7.1	6.8	6.5	40	50	38	32
N. D.....	4,386,286	1,635,384	350,998	2,399,904	5.5	5.8	6.0	5.5	29	37	20	18
S. D.....	8,148,371	3,066,616	442,874	4,638,881	6.2	6.0	6.2	6.4	30	41	27	30
Nebr.....	16,398,680	4,552,087	1,282,722	10,563,871	6.4	6.0	6.1	6.5	40	51	41	35
Kans.....	17,115,638	5,925,590	1,647,363	9,542,685	6.9	6.9	6.5	6.9	31	41	30	30
Ky.....	5,810,535	3,828,564	1,388,619	593,352	6.5	6.7	6.5	6.0	39	52	40	38
Tenn.....	3,664,451	1,632,552	1,624,215	407,684	6.8	6.9	6.8	6.8	50	62	40	40
Ala.....	2,550,100	554,996	1,716,732	278,372	7.3	7.6	7.1	7.0	35	50	30	31
Miss.....	3,392,156	882,199	2,026,533	483,424	7.6	7.7	7.6	7.4	35	50	30	30
La.....	1,348,664	479,152	677,964	191,548	9.1	9.1	9.5	9.1	45	60	45	32
Tex.....	63,523,701	7,427,840	30,698,745	25,397,116	9.4	8.6	9.8	9.6	20	33	18	19
Okla.....	10,013,450	2,581,390	3,008,187	4,423,873	7.2	7.2	7.1	7.4	30	36	25	25
Ark.....	1,716,950	498,368	1,037,025	181,557	7.4	7.5	7.4	7.5	33	40	29	30
Mont.....	7,251,087	1,900,159	899,014	4,451,914	9.0	8.2	7.8	11.5	13	25	14	8
Wyo.....	5,337,249	653,167	583,977	4,100,105	6.2	6.1	5.2	6.4	11	30	8	7
Colo.....	7,366,653	1,337,794	1,088,356	4,940,503	9.1	8.2	7.9	9.2	13	30	14	10
N. Mex.....	6,940,017	1,090,127	1,323,464	4,526,426	10.0	10.8	9.4	8.5	10	70	11	9
Ariz.....	467,677	77,353	102,738	287,586	9.4	9.8	9.5	9.0	8	10	6
Utah.....	1,365,376	271,945	255,241	838,190	6.3	6.7	5.9	6.5	22	40	30	22
Nev.....	2,264,671	939,973	255,555	1,069,143	6.9	7.0	6.5	7.0	9	20	30	7
Idaho.....	1,272,604	271,348	375,418	625,838	6.9	7.0	6.9	6.0	40	60	20	25
Wash.....	3,373,864	390,098	965,331	2,018,435	7.8	7.6	7.4	8.0	20	48	15	14
Oreg.....	5,347,452	716,273	1,668,467	2,962,712	7.0	8.0	8.0	7.0	14	25	11	10
Calif.....	15,035,433	2,913,949	6,445,256	5,676,228	7.9	9.1	8.0	7.0	20	30	15	20
U. S.....	291,439,515	84,226,304	98,445,168	108,768,043	7.4	6.9	7.7	7.7	29.4	45.6	25.4	23.1

BUSHEL WEIGHTS.

TABLE 324.—Commodities for which bushel weights have been established.

State.	Alfalfa seed.	Apples. ¹	Barley.	Beans.					Bluegrass seed.	Bran.	Broom-corn seed.	Buckwheat.	Cabbage.	Cherries. ¹	Chestnuts.	Clover seed.
				Not de- fined.	Green (un- shelled).	Lima.	Soy.	White.								
Federal statutes.....	50	48	60									48		50		
Alabama.....	47	60														
Arkansas.....	50	48						60	14	20	48	52				60
California.....	50	60										40				
Colorado.....	48	60							14			52				60
Connecticut.....	48	60								20		48				60
Florida.....	48	60								20						
Georgia.....	47							60	14	20		52				60
Idaho.....	60	48	60					14	20			50				60
Illinois.....	60	50	48					60	14	20	48	52				60
Indiana.....	60	48	48	60				60	14	20		50				60
Iowa.....	60	48	48	60	56	56			14	20	50	48		40		60
Kansas.....	60	50	48	60	38				14	20	30	48				60
Kentucky.....	47							60	14	20		56				60
Maine.....	60	44	48	60		56	58					48				60
Maryland.....	60	50	48	60					14	20		48				60
Massachusetts.....	60	48	48	60		56	58			20		48				60
Michigan.....	48	48	60						14			48				60
Minnesota.....	60	50	48	60		56			14		57	50			50	60
Mississippi.....	48	48						60	14	20		48				60
Missouri.....	48	48	60	56					14	20		52				60
Montana.....	45	48	60						14	20		52				60
Nebraska.....	60	48	48	60	56	56			14	20	50	50		40		60
Nevada.....	60	48	48	60					14	20		50				60
New Hampshire.....	48	48						58	60	20		48				60
New Jersey.....	50	48	60									48				60
New Mexico.....	60	45	48	60					14	20		52				60
New York.....	48	48	60						20			48				60
North Carolina.....	60	48	48	60	30			60		14	20	44	50	50		60
North Dakota.....	50	48	60						20		30	42				60
Ohio.....	48	48	60								45	50				60
Oklahoma.....	60	48	48	60					14	20	48	52				60
Oregon.....	45	48	46									42				60
Pennsylvania.....	60	45	47	60					14	20	50	48	50		50	60
Rhode Island.....	48	48	60							20		48				60
South Carolina.....	50	48	60	30					14	20	42	50	50		50	60
South Dakota.....	60	48	48	60	50				14	20	50	52		40		60
Tennessee.....	50	48	60	30					14	20	42	50	50		50	60
Texas.....	45	48						60		20		42				60
Vermont.....	60	48	48	60								48			50	60
Virginia.....	60	48	60						14	20		48			57	60
Washington.....	45	48										42				60
West Virginia.....	50	48	60						14	20	57	52				60
Wisconsin.....	60	44	48	60					14	20		50				60

¹ Not defined.

TABLE 324.—Commodities for which bushel weights have been established—Continued.

State.	Corn.				Corn meal. ¹	Cotton seed.			Cranberries.	Flaxseed (linseed).	Grapes. ¹	Hickory nuts.	Kafr corn.	Millet.	Oats.	Onions.
	In the ear.	Shelled.	Popcorn (in ear).	Popcorn (shelled).		Not de-fined.	Sea island seed.	Upland seed.								
Federal statutes		56							56						32
Alabama	70	56				32									32
Arkansas		56			48	33 ¹			56					50	32	57
California		52													32
Colorado	70	56			50										32	57
Connecticut		56			50				55						32	52
Florida		56			48	32	44	30						50	32	56
Georgia	70	56			30				56						32	57
Idaho	70	56			48	32			56				56	50	32	57
Illinois	70	56	70	56	48	32			33	56		50	56	50	32	57
Indiana		56		56	50				33	56		50	56	50	32	57
Iowa	70	56	70	56	48				56	40	50	56	50	32	52	
Kansas		56	70						56	48	50	56	50	32	57	
Kentucky	70	56			50				56					50	32	57
Maine		56			50	44	30	32	56					50	32	52
Maryland	70	56			48				56					50	32	54
Massachusetts		56			50	44	30	32	56						32	52
Michigan	70	56			50			40	56					50	32	54
Minnesota	70	56						36	56		50			48	32	52
Mississippi	72	56			48	32			56					50	32	57
Missouri	70	56			50	33			56					50	32	57
Montana	70	56			50				56						32	57
Nebraska		56	70						56	40	50	56	50	32	57	
Nevada	70	56			48				56			56	50	32	57	
New Hampshire		56			50			32	56						32	52
New Jersey		56							55						32	57
New Mexico	70	56	70	56	50	32			56			56	50	32	57	
New York		56			50	44	30		56						32	57
North Carolina		56	70			30	44		56	48	50	50	50	32	57	
North Dakota	70	56							56					50	32	52
Ohio	68	56	42		48				56		50	56	50	32	56	
Oklahoma	70	56			50	32			56			56	50	32	57	
Oregon		56													32
Pennsylvania		56			50			40	56		50	56	50	32	50	
Rhode Island	70	56			50	44	30		56					50	32	50
South Carolina		56	70			30			56	48	50			50	32	56
South Dakota	70	56	70	56	50				56		50	56	50	32	57	
Tennessee		56	70			28			56	48	50			50	32	56
Texas		56				32			56					50	32	57
Vermont		56		56	50			32	55			56	50	32	52	
Virginia		56			48	30			56					50	32	57
Washington		56							56						32
West Virginia	68	56			48			36	56		50			50	32	55
Wisconsin		56			50	44	30	35	56		50			50	32	50

¹ Not defined.

TABLE 324.—Commodities for which bushel weights have been established—Continued.

State.	Peaches.	Peanuts.	Pears.	Peas. ¹	Plums.	Potatoes, Irish.	Potatoes, sweet.	Rice, rough.	Rye.	Rye meal.	Timothy seed.	Tomatoes.	Turnips.	Walnuts.	Wheat.
Federal statutes	50	50	60	50	60	60	55	56	56	60	55	55	60	60	60
Alabama	60	60	60	60	60	60	50	56	56	60	60	60	60	60	60
Arkansas	60	60	60	60	60	60	50	56	56	60	60	60	60	60	60
California	60	60	60	60	60	60	54	56	56	60	60	60	60	60	60
Colorado	60	60	60	60	60	60	54	56	56	60	60	60	60	60	60
Connecticut	60	60	60	60	60	60	54	45	56	50	45	54	55	60	60
Florida	54	22	55	40	60	60	56	56	56	56	45	56	54	60	60
Georgia	25	60	60	60	60	60	55	43	56	45	45	56	55	60	60
Idaho	48	60	60	60	60	60	50	56	56	45	56	56	55	60	60
Illinois	48	20	58	60	60	60	50	45	56	50	45	56	55	50	60
Indiana	48	50	60	60	60	60	50	45	56	45	60	55	50	60	60
Iowa	48	22	45	60	48	60	50	56	56	45	50	55	50	60	60
Kansas	48	45	60	52	60	60	50	56	56	45	56	55	50	60	60
Kentucky	24	60	60	60	60	60	55	56	56	45	60	60	60	60	60
Maine	48	20	58	60	60	60	54	44	56	50	45	56	60	60	60
Maryland	40	22	60	60	60	60	60	56	56	45	60	60	60	60	60
Massachusetts	48	20	58	60	60	60	54	44	56	50	45	56	55	60	60
Michigan	60	28	60	60	60	60	56	56	56	45	58	60	60	60	60
Minnesota	48	22	45	60	60	60	55	56	56	45	50	55	50	60	60
Mississippi	24	60	60	60	60	60	54	56	56	45	55	55	60	60	60
Missouri	48	48	60	60	60	60	56	56	56	45	45	42	60	60	60
Montana	45	60	60	60	60	60	56	56	56	45	50	60	60	60	60
Nebraska	48	22	45	60	48	60	50	56	56	45	56	55	50	60	60
Nevada	48	60	60	60	60	60	50	56	56	45	56	56	60	60	60
New Hampshire	48	20	58	60	60	60	54	56	56	50	45	56	60	60	60
New Jersey	50	60	60	60	60	60	54	56	56	45	60	60	60	60	60
New Mexico	48	22	48	60	60	60	50	56	56	45	50	56	60	60	60
New York	60	60	60	60	60	60	54	56	56	50	45	60	60	60	60
North Carolina	50	22	56	60	64	60	56	45	56	45	56	50	50	60	60
North Dakota	60	60	60	60	60	60	46	44	56	45	60	60	60	60	60
Ohio	48	60	50	60	60	60	50	56	56	45	56	60	50	60	60
Oklahoma	48	22	48	60	60	60	55	56	56	45	45	42	60	60	60
Oregon	45	60	60	60	60	60	56	56	56	45	60	60	50	60	60
Pennsylvania	48	22	50	60	64	60	54	45	56	50	45	60	60	50	60
Rhode Island	48	60	60	60	60	60	54	56	56	45	56	50	60	60	60
South Carolina	50	23	36	60	64	60	50	56	56	45	56	50	50	60	60
South Dakota	48	20	60	60	60	60	46	56	56	45	50	55	50	60	60
Tennessee	50	23	56	60	64	60	50	56	56	45	56	50	50	60	60
Texas	50	60	60	60	60	60	55	56	56	45	55	55	60	60	60
Vermont	48	20	58	60	48	60	54	56	56	45	56	60	60	60	60
Virginia	22	60	60	60	60	60	56	56	56	45	60	55	60	60	60
Washington	45	60	60	60	60	60	56	56	56	45	60	60	60	60	60
West Virginia	48	60	60	60	60	60	50	56	56	45	56	60	60	60	60
Wisconsin	48	48	60	60	60	60	54	45	56	50	45	56	42	60	60

¹ Not defined.



INDEX.

	Page.
Abaca fiber, use in making binder twine.....	359
Abruzzi rye, value and yields.....	175, 176
Accounts, cotton warehouse, importance, suggestions.....	426-427
Accredited-herd, plan in tuberculosis eradication article, by J. A. Kiernan....	215-220
Acetone, demand for war uses, and wood used in making.....	321-322
Acids, use in soft drink, composition and quantities.....	120
Africa, East, sisal growing, notes.....	362
<i>Agava</i> —	
<i>cantala</i> , growing in Philippines, fiber quality, etc.....	363
<i>fourcroydes</i> . See Henequen.	
<i>sisalana</i> . See Sisal.	
Agents, county, need of knowledge of forest conditions.....	325-326
Agricultural—	
Advisory Committee, National, personnel and work.....	20
colleges, list with locations and presidents.....	443-445
conditions, ignorance concerning.....	9-11
products—	
exports, 1852-1918, statistics.....	644-646
foreign trade, total imports and exports, 1852-1918.....	642
imports and exports, statistics.....	627-665
imports, 1852-1918, selected list.....	647-649
statistics, miscellaneous.....	667-726
Agriculture—	
Department, emergency work.....	23-24, 71-72
legislation aiding and developing.....	59-60
numbers engaged in, by countries.....	714
official agencies, cooperation in food production increase.....	19-21
Secretary, recommendations.....	58, 68, 69, 70, 71, 72
report.....	9-73
State officials in charge of, list.....	445-446
stimulation, cooperation of official agencies.....	19-23
Airplane propellers, woods used.....	319, 320-321
Alabama, Forests, National, area.....	717
Alaska, Forests, National, area.....	717
Alcohol, wood—	
demand for war purposes.....	322
exports, statistics.....	638
Alfalfa—	
hay, prices on farm, 1914-1918.....	526
seed, bushel weights.....	723
Almonds imports, statistics.....	632, 647
Animal—	
diseases, control work.....	26-28, 72
Industry Bureau—	
hog cholera control work.....	191-192
work in meat supply increase.....	23, 24-31
products—	
exports, statistics.....	635-636, 643
imports, 1916-1918, statistics.....	627-629, 642, 660-662
statistics.....	591-595, 606-611, 618-622
Animals—	
breeding, prices, 1918, highest on record.....	289
diseased, destruction at quarantine station.....	243
farm, statistics.....	587-626
inspection and condemnations.....	30-31
live—	
exports, statistics.....	635, 643, 654
imports, 1916-1918, statistics.....	627, 642, 660

	Page.
Animals—Continued.	
meat, number slaughtered under Federal inspection, 1907–1918.....	625
predatory, extermination.....	28–29
pure-bred, prices, 1918, highest on record.....	289
slaughtered, condemnations for disease.....	625–626
<i>See also</i> Cattle; Goats; Hogs; Horses; Sheep.	
Appeals, grain grading, work of supervisors.....	339–340, 342
Appendix.....	443–726
Apple—	
acreage, commercial, regional distribution, map.....	370
Albemarle Pippin, same as the Yellow Newton.....	372
Baldwin, growing commercially, localities, etc.....	371, 373
Ben Davis, growing commercially, localities, etc.....	372, 373
early, production and kinds.....	689
exportations to England, importance.....	372
industry—	
commercial, in the United States.....	367–378
future, hopeful outlook.....	376–377
production, commercial, by States and regions, table.....	378
Spitzenburg, growing commercially, localities, etc.....	375
Winesap, growing commercially, localities, etc.....	372, 373
Yellow Newton, growing commercially, localities, etc.....	372, 375
Apples—	
Baldwin New England belt, commercial production.....	371
bushel weights.....	723, 726
exports—	
statistics.....	639, 645, 656
prices on farm, 1910–1918.....	547
production—	
commercial, by States, and by regions.....	545–548
increasing importance.....	367–369
varieties grown commercially, notes.....	370–376
varieties, production, by States.....	548
Apricots, exports, statistics.....	639, 656
Arable land—	
area and location.....	433–441
total and classes.....	438
Argols, imports, statistics.....	629, 643, 647
Arizona, Forests, National, area.....	717
Arkansas—	
apple growing, localities, varieties, and production.....	370, 373, 378
Cypress Creek drainage district, acreage.....	140
Forests, National, area.....	717
Ash lumber, value and uses.....	318, 320–321
Asses, numbers in world countries.....	587–591
Associations, community poultry breeding, article by J. W. Kinghorne.....	109–114
ATKINSON, JAMES, article on "Government market reports on live stock and meats".....	379–398
BACK, E. A., article on "How weevils get into beans".....	327–334
Bacon, imports, statistics.....	628, 651
Bag limits, game birds.....	311
BAKER, O. E., and H. M. STRONG, article on "Arable land in the United States".....	433–441
Bananas, imports, statistics.....	631, 651, 663
Banks, aid in dairy work, Grove City, Pa.....	157–159
Barberries, description.....	89, 90, 91
Barberry—	
and related plants, list.....	91
and the black stem rust, article by E. C. Stakman.....	75–100
common—	
eradication for control of black stem rust.....	88–100
origin, distribution, and spread.....	92–93
dwarf, description, etc.....	89
eradication—	
directions.....	100
laws.....	98–99

Barberry—Continued.	Page.
host of black stem rust, manner of infection.....	80, 81, 82, 84, 94-98
Japanese, description, resistance to black stem rust.....	89-91, 98
native species, distribution.....	93
species and varieties harmful and harmless, descriptions.....	89-91
Barley—	
acreage—	
and production, 1910-1918.....	13, 14
production and farm value, by States, 1918.....	486
production and farm value, revised, 1879, and 1889-1909.....	486
production, value, exports, etc., 1849-1918.....	485
bushel weights.....	723-725
condition on first of month, 1897-1918.....	487
consumption by countries, 1902-1911.....	684
damage by black stem rust.....	75, 76
exports—	
and imports, 1911-1913, 1916-1917, by countries.....	489
statistics.....	639
price on farm first of months, 1909-1918.....	488
prices on principal markets, 1913-1918.....	488
statistics, acreage, yield, values, prices, exports, etc.....	482-489
trade international, 1911-13, 1916-17.....	489
world's area and production, 1916-1918.....	482-484
yield, prices Dec. 1 and values, by States.....	487
Bean weevils—	
life cycle, description and illustrations.....	329-331, 334
plates, description.....	334
Beans—	
acreage, production and distribution.....	688
bushel weights.....	723
exports, statistics.....	641
imports, statistics.....	634, 643
prices on farm, 1910-1918.....	558
seed—	
growing, localities, acreage, yield, production, and consumption.....	204, 206, 207
weevil detection by signs.....	327, 331-333
statistics, acreage, production, and prices.....	556-559
weevil infestation, explanation, article by E. A. Back.....	327-334
world crop, statistics.....	556-557
Beans. <i>See also</i> Castor.	
Beef—	
cattle, prices cycle, graphic showing.....	706
exports, statistics.....	636, 644, 654
imports, statistics.....	628
production, increase since 1914.....	13, 16
trade conditions, receipts, and prices, December, 1918.....	381-383
Beeswax	
exports, statistics.....	635
imports, statistics.....	627, 648
Beets—	
bushel weight.....	726
garden, seed growing, localities, acreage, yield, production, and consumption.....	205, 206, 207
sugar—	
acreage and production, 1916-1918, analyses, etc.....	565-566, 572-573, 575
seed growing, localities, acreage, yield, production, and consumption.....	205, 206, 207
seed, imports, statistics.....	633
Belgium, rabbit-growing industry, extent.....	146, 149
Belgian hare. <i>See</i> Hare; Rabbit.	
<i>Berberis</i> spp. descriptions, and comparisons.....	89-91
<i>See also</i> Barberry.	
BIGGAR, H. HOWARD, article on "The old and the new in corn culture".....	123-136
Binder twine—	
fibers, sisal and henequen, article by H. T. Edwards.....	357-366
<i>See also</i> Twine.	
Biological Survey, enforcement of Migratory-bird Act.....	315-316

Birds—

	Page.
game—	
bag limits and export restrictions.....	311
farming.....	313-314
traffic restrictions.....	310, 311, 313
injurious, control.....	314-315
migratory—	
conservation, future outlook.....	316
food value and economic importance.....	303
law of 1913, and its repeal in 1918.....	305-306
open seasons, general conditions.....	304-305, 311-312
protection, Federal, article by George A. Lawyer.....	303-316
sale prohibition.....	313
treaty act, provisions and regulations.....	308-313
treaty, adoption and terms.....	307-308
unprotected by treaty, list.....	307
protection, State laws, conditions.....	303-305, 309-310
Bituminous road materials, demands for and control of.....	56, 57
Blue-grass seed, bushel weights.....	723
Bobolink, rice destruction, control, and use restrictions.....	315
Bollworm, pink, control work.....	38-42
Bonds, drainage, value.....	139
Borrowers of cattle loans, security, rates, etc.....	108
Bottled soft drinks, composition and food value, article by J. W. Sale and W. W. Skinner.....	115-122
Box lumber, demand during war.....	317
Boys' club work, dairy cattle, design and results.....	163
Braiding corn ears for drying, Indian practice.....	124, 130
Brandy, imports, statistics.....	632
Brazil nuts, imports, statistics.....	632
Bread making, rye and wheat, comparison.....	171-172
Breadstuffs, exports, statistics.....	639
Breed, poultry, selection for community work.....	109-110, 111
Breeders, cattle, in favor of accrediting herds.....	217-218
Breeds—	
rabbit, description.....	148-150
sheep, per cent of flocks, by States.....	617
Brewing, materials used.....	709
Bristles, imports, statistics.....	628
Broom corn—	
exports, statistics.....	637
prices on farm, 1910-1918.....	561
seed, bushel weight.....	723
statistics, acreage, production, value, and prices.....	561
BROWN, RALPH H., article on "The farmer and Federal grain supervision".....	335-346
Buckwheat—	
acreage—	
production and farm value, by States.....	497
production and farm value, revised, 1879 and 1889-1909.....	497
bushel weights.....	723
condition on first of months, 1898-1918.....	497
farm price, first of months, 1909-1918.....	498
statistics, acreage, yield, values, prices.....	497-498
yield, price Dec. 1 and value, by States.....	498
Buffaloes, numbers in world countries.....	587-591
Building materials, demand, drain on farm wood lots.....	318
Buildings—	
dairy, improvement, result of community work.....	163-164
for cotton warehouses, fire protection.....	408-420
<i>See also Cottages; Houses; Warehouse.</i>	
Bull associations, organization and work, Grove City, Pa.....	160-161
Bushel weights, commodities and States.....	723-726
Butter—	
exports, statistics.....	608, 635, 654
imports, statistics.....	608, 627
market receipts, 1891-1918.....	608
prices.....	606-607
statistics, prices, exports, imports, and market receipts.....	606-608

	Page.
Butter-fat production, relation to feed and cost of feed.....	160
Buttermilk, profits in dairy industry.....	155, 166
Buttonwood, use by Indians in corn growing.....	129
By-products, creamery, value in dairy industry.....	155, 166
Cabbage—	
farm prices, 1910-1918.....	710
seed growing, localities, acreage, yield, production, and consumption.....	202, 206, 207
Cabinet woods, imports, statistics.....	630, 665
Caches, use in storing corn, Indian practices.....	130, 132
California—	
apple growing, localities, varieties, and production.....	370, 375, 378
Forests, National, area.....	717
oranges, production and prices.....	551
Calves—	
number slaughtered for food.....	30
prices, cycle, graphic showing.....	706
Camphor, imports, statistics.....	630, 650
Canada—	
barberry-eradication law.....	99
treaty for protection of migratory birds.....	307, 308
Cane, sugar, acreage and production, 1911-1918.....	567, 574
Canker, citrus, eradication work.....	43
Canned—	
fruits, exports, statistics.....	639, 656
vegetables, exports, statistics.....	641
Capital Issues Committee, cooperative work on highways.....	55-56
Capsicum, use in soft drinks.....	120, 121
Carbon dioxid gas, use in bottled soft drinks.....	119, 121
Carrot, seed growing, localities, acreage, yield, production, and consumption.....	200, 206, 207
Carrots, bushel weight.....	726
Cars, disinfection in pink bollworm quarantine.....	40-41
Cassia, imports, statistics.....	634
Castor beans—	
bushel weight.....	726
imports, statistics.....	633
Cattle—	
accredited-herd plan in tuberculosis eradication, article by J. A. Kiernan.....	215-220
exports—	
and value, 1893-1918.....	601
statistics.....	635-644, 654
grazing, National Forests.....	29
herds, accrediting, methods and rules.....	215-217
Hereford, prices and demand in England, 1918.....	289
Holstein-Friesian, Soldiers' Home, D. C., accredited herd.....	219
imports—	
exports, and value, 1893-1918.....	601
statistics.....	627, 660
loan companies, organization, officials, and usefulness.....	101-102, 107
loans—	
and their value to investors, article by Charles S. Cole.....	101-108
rediscounting and safeguarding.....	105-106
movement from Texas drouth-stricken areas.....	25
number—	
in world countries.....	587-591
on farms, 1910-1918.....	13, 15
proportion to population, 1900-1919.....	290
slaughtered for food.....	30
prices—	
at markets, 1913-1918.....	604
on farms, 1910-1918.....	605
receipts at stockyards, December, 1917 and 1918.....	394-397
scab, control.....	28
shipments, reports, Dec. 19, 1918.....	384-387
statistics, number, value, prices, exports, and imports.....	601-605
tick, eradication, progress, and recommendation.....	26, 72
<i>See also</i> Bull; Calves; Cows.	

	Page.
Celery—	
growing on reclaimed marsh lands, note.....	139
seed growing, localities, acreage, yield, production, and consumption. 200, 206, 207	
Cereals—	
acreage and production, 1910–1918.....	12, 13, 14
consumption in selected countries, 1902–1911.....	684
<i>See also</i> Barley; Grain; Oats; Wheat.	
Cheese—	
cottage—	
an old dish, rediscovery, article by Herbert P. Davis.....	269–276
farm campaign for.....	270, 273–274
menu.....	272
palatability.....	269, 272, 274, 275
profits in dairy industry.....	155, 166
publications, list.....	276
use as meat substitute.....	271, 272, 274, 275
Dutch. <i>See</i> Cheese, cottage.	
exports—	
and imports.....	611
statistics.....	635, 644
imports, statistics.....	627, 647, 651, 660
statistics, exports and imports, 1909–1917.....	611
Chemistry Bureau, cooperation with War Department, etc.....	24
Chestnut wood, demand for tanning purposes.....	320
Chicago live-stock market reports, Apr. 1, 1919.....	389–390
Chickens—	
farm prices, 1914–1919.....	710
prices, 1909–1918.....	612
White Wyandotte, breeding success, Christian County, Ky.....	110–111
Chicle imports, statistics.....	630
Cholera, hog—	
control, article by O. B. Hess.....	191–194
control work.....	26–27, 72
decrease under work of veterinarians.....	191–194
Cities, response to demand for farm labor.....	49–50
Citrus canker, eradication work.....	43
City—	
markets, preferences, and fancy products.....	280, 282
source of farm labor objections to farms.....	347–348
Clearing, lands after drainage, costliness.....	140–142
Clover—	
hay, prices on farm, 1914–1918.....	526
red, seed, prices, 1907–1918, effect of the war.....	211
seed—	
acreage, production, and value by States.....	527
bushel weights.....	723
exports, statistics.....	641
farm price, 1910–1918.....	527
imports, statistics.....	633
prices in principal markets, 1913–1918.....	528–529
Clubs—	
boys' and girls'—	
cottage cheese, work.....	274
dairy cattle, design and results.....	163
rabbit growing, work.....	152
Cocoa—	
exports, statistics.....	637, 643
imports, statistics.....	629, 643, 647, 651, 662
Coconut oil, imports, statistics.....	633
Coconuts, imports, statistics.....	632
Coffee—	
exports—	
and imports, 1909–1917.....	579
statistics.....	637, 643
imports, statistics.....	629, 643, 647, 651, 662
prices, New York and New Orleans markets, 1913–1918.....	580–581
statistics, exports, imports, and prices.....	579–581
COLE, CHARLES S., article on "Cattle loans and their value to investors" . . .	101–108

	Page.
Colleges—	
agricultural—	
cooperation in food production increase.....	19
list with locations and presidents.....	443-445
Colonists, corn growing and uses in early days.....	123, 132-133
Colorado—	
Forests, National, area.....	717
rainfall average.....	434
Colorings, soft drinks, composition.....	119-120
Commercial Club, Grove City, relation to dairy work.....	156-157
Community—	
organization, Grove City, Pa., result of dairying.....	165-168
poultry breeding associations, article by J. W. Kinghorne.....	109-114
Condiments, use in soft drinks.....	120-121
Cooking, thrashing help, problem in cooperative work.....	256-257
Cooperation—	
cities with farm communities, desirability.....	10
cotton growers, for warehousing cotton, need and suggestions.....	404-406
necessity in clearing land after drainage.....	142-144
shipping produce to market, and competition.....	279-280
thrashing, saving in labor, etc.....	248-250
Cooperative extension work, State officers.....	446
Copal, imports, statistics.....	630
Copra, imports, statistics.....	632
Cork, wood or bark, imports, statistics.....	629
Corn—	
acreage—	
and production, 1910-1918.....	12, 14
grown by Indians in colonial days, references.....	123, 128
production and farm value by States, 1917 and 1918.....	451-452
production and farm value, revised, 1879, 1889-1909.....	452
production, value, exports, etc., 1849-1918.....	450-451
adaptability and variations in responding to selection.....	135
belt, thrashing ring, article by J. C. Rundles.....	247-268
breeding, variations and adaptability to conditions.....	135
broom. <i>See</i> Broom corn.	
bushel weights.....	344, 724
classification and standards.....	675
condition by months, 1898-1918.....	457
consumption by countries, 1902-1911.....	684
crop—	
use and value in European war.....	135-136
uses in towns and on farms.....	674
variation yearly, graphic showing.....	690
culture, the old and the new, article by H. Howard Biggar.....	123-136
exports—	
and imports, 1909-1913, 1916, 1917, by countries.....	457
statistics.....	639, 645, 657
farm prices, first of months, 1909-1919.....	457
foods, preparation, Indian methods.....	130-131
grades—	
determination.....	37
shelled corn.....	675
growing—	
and uses, old and new methods.....	123-136
early history in America, and primitive customs.....	123-130, 131-132
westward movement, and live-stock industry.....	132-134
harvesting of the crop, methods with percentages, by States.....	673
imports, statistics.....	631, 652
kinds, percentages in crops of 1917 and 1918.....	672
marketings monthly by farmers, 1913-1918.....	676
origin, and value to early colonists in America.....	123-125
planting, primitive methods, tools, etc.....	127-129
pop, prices on farm, 1912-1918.....	678

Corn—Continued.	
prices—	Page.
comparison with prices of hogs.....	678
on principal markets, 1913-1918.....	455-456
production and distribution, United States, 1897-1918.....	453
seed—	
selection and storing, Indian practices.....	129-130, 132
testing methods, primitive.....	126-127
shelled, standards tabulated.....	344
standards and classes for shelled corn.....	675
statistics, acreage, yield, values, prices, exports, etc.....	449-457
storing in caches.....	130, 132
sweet, seed growing, localities, acreage, yield, production and consumption.....	202, 206, 207
use as silage.....	134
use in brewing.....	709
varieties grown by American Indians, and later variation.....	125, 135
weight per bushel, different grades.....	344
world's area and production, 1916-1918.....	449-450
yield, price and value per acre, by States.....	454
Corns, flint and flour, uses among Indians.....	125
Cottage cheese—	
old dish, rediscovery, article by Herbert P. Davis.....	269-276
profits in dairy industry.....	155, 166
<i>See also</i> Cheese, cottage.	
Cottages, farm laborers', plans, with grounds.....	352-356
Cotton—	
acreage—	
and production, 1910-1918.....	14, 15
harvested by States, 1909-1918.....	532
production, value, exports, etc., 1866-1918.....	531
belt, rye growing, adaptability.....	174-175
compress, connection with warehouse, desirability.....	406
condition by months, 1897-1918.....	532
"country damage," loss from.....	404
crop variation yearly, graphic showing.....	692
damaged, warehousing, management.....	420-422
exports—	
and imports, by countries, 1909-1917.....	536
statistics.....	637, 643, 645, 655
fire protection in warehouses.....	408-416
freight tonnage by rail, 1915-1917.....	711
Futures Act, administration, etc.....	59
grading, practices, suggestions for improvement.....	416-417
growers—	
cooperation in cotton storage, need and suggestions.....	404-406
financing, relation of warehouse.....	404
handling at warehouse, devices.....	422-423
imports, statistics.....	629, 643, 662
insurance in warehouse, practices, discussion, rates, etc.....	423-426
low-grade, distribution work of Department.....	37-38
marketing, relation of warehouse.....	400
Mexican, quarantine for pink bollworm.....	38, 40-41
middling upland, prices on principal markets, 1913-1918.....	534
pink-bollworm eradication work.....	38-42
price—	
farm, first of months, 1909-1918.....	533
fluctuations, influence of supply.....	400-403
middling upland on principal markets, 1913-1918.....	534
production of lint by States, 1909-1918.....	532
protection, economic importance.....	404
sampling, practices, cause of loss to grower, suggestions.....	416-417
Sea Island and Egyptian, acreage and production, 1917 and 1918.....	687
statistics, acreage, yield, value, prices, exports, etc.....	530-537
trade international, by countries, 1909-1917.....	536
value as collateral.....	427
warehouse receipt under Warehouse Act.....	427-432
warehousing, benefits of adequate system, article by Roy L. Newton and James M. Workman.....	399-432

Cotton—Continued.	
weighing—	
equipment, types of scales.....	417-420
importance, variations, in weight, etc.....	417-420
world's area and production, 1915-1917.....	530-531
yield, prices, Dec. 1, and value by States.....	533
Cotton-free belt, Texas border.....	40
Cottonseed—	
bushel weights.....	724
cake and meal exports, statistics.....	640, 645
oil, trade, international, 1909-1917.....	537
prices on farm, 1913-1918.....	536
Cover crop, rye, value.....	177-178
Cow-testing association, aid to success in dairying.....	159-160
Cows—	
milch, number on farms, 1910-1918.....	13, 15
prices, cycle, graphic showing.....	705
<i>See also</i> Cattle.	
Cranberries—	
bushel weights.....	724, 726
statistics, acreage, production, and value.....	552
Creamery, Grove City, Pa., management and progress.....	154-155
Credit, associations among farmers.....	60-62
Credits, personal, development in farming communities.....	60-62
Crop—	
Estimates Bureau, work on crop reports, object and value.....	43-46
forecasts, importance to producers, 1919.....	277-278
lands, increase by plowing pastures, 1914-1918.....	439
production, index numbers, 1910-1918.....	701
region, United States, limits.....	433
reports, monthly, scope, object, and value to agriculture.....	44-46
summary, 1918, 1917, and average, 1912-1916.....	667-669
Crops—	
acreage, yield, and production, increase, 1917-1918.....	11-12, 14-15
conditions for production.....	434-435
estimating, methods.....	45
grain, statistics, 1918.....	449-506
other than grain, statistics.....	507-586
planting—	
plans for 1919.....	17-18
viewpoint of growers, effect on supply.....	273
prices in index numbers, 1909-1918.....	701
production per man and per acre, by countries.....	693
sales time of farmers for principal staples.....	693
staple—	
increase of production and yield.....	440
leading States.....	669
statistics, miscellaneous.....	667-726
values, comparisons by States.....	670
variation yearly in production.....	690-692
Cross-section, stream, measurement directions.....	227-229
Cucumber, seed growing, localities, acreage, yield, production, and consumption.....	201, 206, 207
Cucumbers, bushel weight.....	726
Cured meats, stocks reported, Dec. 1, 1917, and Dec. 1, 1918.....	392-393
Currants, imports, statistics.....	631, 648
Cut-over lands, reclamation for cultivation, notes.....	436
Dairy—	
buildings improvement, result of community work.....	163-164
cattle show and sales association, requirements.....	164-165
herd, saving by use of skim milk for cottage cheese.....	274
herds, tuberculosis testing.....	162-163
products—	
exports, statistics.....	635, 643
imports, statistics.....	627, 643, 660
market news service.....	33
output increase.....	30
supply by America, 1919.....	291, 299
<i>See also</i> Butter; Cheese; Milk.	

	Page.
Dairying—	
community upbuilding, example, Grove City, Pa.	153-168
Pennsylvania, Grove City, building up community	153-168
DANIELS, A. M., article on "Electric light and power from small streams"	221-238
Dates, imports, statistics	631, 648
DAVIS, HERBERT P., article on "The rediscovery of an old dish"	269-276
DEARBORN, NED, article on "Rabbit growing to supplement the meat supply"	145-152
Denmark, stem rust control by eradication of barberry	100
Demonstrations, cottage cheese making	270-272
Department, Agriculture, cooperation with other departments, etc.	23-24
<i>See also</i> Agriculture.	
Desert land, area in United States	435, 439
Diet, variety added by use of cottage cheese	273, 274
Diseases—	
animal, control work	26-28, 72
live-stock quarantine, some results, article by G. W. Pope	239-246
Distilling, rye, use and quality	181
Dockage, wheat, removal at thrashing	335
Drainage—	
districts, rights and powers	139, 143
expense for reclamation of lands	436-437
laws and drainage districts, bonds, etc.	139-140
movement in the United States, article by S. H. McCrory	137-144
Drinks, soft—	
bottled, composition and food value, article by J. W. Sale and W. W. Skinner	115-122
bottling, objectionable practices	121
consumption in rural communities	115
Drouth regions, emergency work, aid by Department	25, 34, 46-49
Dry farming, possibilities in West	437-438
Drying seed corn, Indian methods	130, 132
Ducks—	
protection under Federal regulations	312
wild, rice destruction, control in California	314
Dyewoods, imports, statistics	629, 643
EDLER, G. C. and W. A. WHEELER, article on "Some effects of the war upon the seed industry of the United States."	195-214
EDWARDS, H. T., article on "Sisal and henequen as binder-twine fibers"	357-366
Eggs—	
exports, statistics	635
imports, statistics	627, 643
production, increase since 1914	13, 16, 25
statistics, prices, and market receipts	609-611
Electric light and power from small streams, article by A. M. Daniels	221-238
Electricity, requirements for farm and home, estimating	222-225
Elevators, grain-grading details	336-339
Emergency—	
food production, extension of appropriation	71-74
production work	23-24, 71-72
work, increased activity in extension service	21-23
England, barberry-eradication law	99
Erosion, danger in cutting trees on hill slopes, precaution	323
Europe, rabbits consumed to supplement meat supply	146
Exhibits—	
Government joint committee, composition and work	53
office, work of year, exhibits, demonstrations, etc.	52-53
poultry, community	114
Experiment stations, agricultural, list, with locations	445
Export, game birds, restrictions	311
Exports—	
agricultural, statistics	635-641, 642-646, 649-650, 652-660
barley and malt, by countries	489
cotton, by countries, 1909-1917	536
cottonseed oil, by countries, 1909-1917	537
meat and meatfood products, certification	31
potatoes, 1911-1917	516

Exports—Continued.	Page.
rice, by countries, 1909-1913, 1916-1917	506
seed, 1914-1918, effects of the war	195-197
sugar, statistics	570
tobacco, by countries, 1909-1917	544
Extension service, cooperative emergency work	21-23, 71
Factories, sugar, beet and cane, statistics	566, 572-574
Farm—	
home, electricity requirements for light and power	222-225, 236-238
labor—	
hiring, etc., by States	695-696
supply, work of Department	49-50
Loan—	
Act, progress and results	59-60, 66
Board, operations, beneficial to farmers	61-62, 66
loans, aid to settlement of farm lands	66
ownership, conditions, encouragement	65-66
prices, 1910-1919	709-710
products—	
export trade	671
exports and imports, values, 1916-1918	642-643
exports, destination, 1910-1918	654-660
freight, tonnage by rail, 1915-1917	711
imported from specified countries, 1910-1918, statistics	651-652
imports, 1910-1918, with countries of origin	660-665
shipments to and from Hawaii and Porto Rico	653
values estimated on farm prices, 1879-1918	671
world production	671
tenancy, relation to ownership	65-66
woodlands and the war, article by Henry S. Graves	317-326
workers, houses for, article by E. B. McCormick	347-356
Farmer—	
benefits of Federal grain supervision, article by Ralph H. Brown	335-346
water rights in streams, discussion	235
Farmers—	
food production increase, work, 1917, 1918	11-16
in drouth areas, seed loans applications, and amount	48
market service offices at shipping points, location—	
prices for principal articles	694
selling time for crops	693
soda nitrate supply by Markets Bureau	24, 54-55
Farming—	
extension, importance	63
game birds	313-314
improvement, public agencies	10
Farms—	
abandoned, notes	437, 441
apples, growing for home use	369
disinfection for hog cholera, work of Department	192
number estimated as existing and prospective	438
uses of corn	674
Farmville Barred Plymouth Rock Association, organization and work	110
Feathers—	
exports, statistics	635-643
imports, statistics	627
Federal Reserve Act, benefit to farmers	59
Feed—	
dairy cows, cost, relation to butter-fat production	160
law, Federal, need	70
market news service, biweekly statements	33-34
value of rye	180-181
Feedstuffs, shortage in Europe	290, 294, 295, 297, 298, 299
Fertilizer—	
law, Federal, need	71
mixtures, formulas	189-190

Fertilizers—	Page.
commercial, mixing directions and formulas.....	187-190
composition.....	186
home mixing—	
article by C. C. Fletcher.....	185-190
profits.....	190
materials supplying nitrogen, phosphoric acid, and potash.....	186
prices, saving by home mixing.....	190
purchasing, suggestions.....	186
Fever, malarial, horse and sheep, conveyance by ticks.....	245
Fiber cleaning machinery, use in Philippines and Porto Rico.....	364, 365
Fibers—	
animal—	
exports, statistics.....	635, 643
imports, statistics.....	627, 643, 661
binder-twine—	
production and cost.....	359-360
sisal and henequen, article by H. T. Edwards.....	357-366
vegetable, imports, statistics.....	629, 643, 662-663
<i>See also Cotton; Flax; Hemp; Henequen; Istle; Jute; Kapoc; Silk; Wool.</i>	
Field agents, Crop Estimates Bureau, work and number.....	44, 45
Figs, imports, statistics.....	631, 648
Filberts, imports, statistics.....	632
Fire protection—	
cotton warehouses.....	408-416
equipment for cotton warehouse.....	415-416
Fires, forest, control, cost and methods.....	57-58
FISKE, G. B., article on "Following the produce markets".....	277, 288
Flavoring extracts, exports, statistics.....	637
Flavors, soft drinks, food value.....	116-118, 122
Flax—	
imports, statistics.....	629, 647, 663
marketings monthly, 1913-1918.....	687
statistics, acreage, yield, values and prices.....	499-502
world's acreage and production, 1915-1917.....	499-500
Flaxseed—	
acreage, production—	
farm values, by States, 1918.....	501
value and condition, 1849-1918.....	500
condition first of months, 1902-1918.....	500
farm price first of months, 1909-1918.....	501
imports, statistics.....	633
oil cake, exports, statistics.....	640
prices on principal markets, 1913-1918.....	502
yield, price, Dec. 1, and value by States.....	501
FLETCHER, C. C., article on "Home mixing of fertilizers".....	185-190
Florida—	
citrus canker, prevalence and control work.....	43
Forest, National, area.....	717
oranges, production and prices.....	551
Southern, sisal industry, introduction problems.....	365
Flour—	
exports, statistics.....	639, 645
imports, statistics.....	631
prices on principal markets, 1913-1918.....	471
wheat, mixture with rye in bread making.....	171, 183
FOLGER, J. C., article on "The commercial apple industry in the United States".....	367-378
Food—	
allowance cards, England and France.....	291
conservation by making cottage cheese.....	270-271, 274, 275
increase of staple crops, five year averages since 1866.....	440
production, increase—	
methods.....	63
plans for 1919.....	17-19
work of farmers, 1917, 1918.....	11-16
products, inspection-service work, 1918.....	35-36
supply of United States and world, problem.....	357

	Page.
Food—Continued.	
value—	
and composition of bottled soft drinks.....	115-122
of skim milk.....	269-271, 273-274, 275
Foods—	
corn, preparation, Indian methods.....	130-131
pure, Army and Navy, work of Animal Industry Bureau.....	31
Foodstuffs, foreign trade.....	672
Foot-and-mouth disease, need of complete eradication.....	241-242, 243
Forecasts, crop, importance to producers.....	277-278
Foreign trade. <i>See</i> Exports; Trade; etc.	
Formulas, fertilizer mixtures.....	189-190
Forest—	
conditions, knowledge needed by county agents.....	325-326
fires, control, cost and methods.....	57-58
land, area in United States.....	436, 438
products—	
exports and imports, values, 1916-1918.....	637-638, 643, 650-651
exports, statistics.....	637-638, 643, 650, 659-660
foreign trade, 1852-1918.....	649
imports, statistics.....	629-631, 643, 650-651
war demands and uses.....	317-326
Service, cooperation with Navy Department, etc.....	23-24
Forests—	
National—	
area of lands, 1918, by States.....	717-718
extending into two States, list with areas.....	719
grazing allowances, 1918.....	719
need of roads, trails, etc., in fire control.....	58
ranges, utilization for live-stock grazing.....	29-30
timber quantities, prices, etc.....	716-721
relation to arable-land conditions.....	434
France—	
barberry eradication laws.....	98, 99
live-stock conditions and losses during war.....	296-298
Frosts, relation to arable-land conditions.....	435
Frozen meats, stocks reported, Dec. 1, 1917, and Dec. 1, 1918.....	392-393
Fruit and vegetables, freight tonnage by rail, 1915-1917.....	711
Fruits—	
exports, statistics.....	639, 643, 656
imports, statistics.....	631, 643, 663
market-news service, branch offices, etc.....	32, 280, 281, 286-288
production, increase since 1910.....	15
weights of bushel.....	726
Fuel—	
Administration, cooperation in supply of road materials.....	56, 57
wood value and importance.....	322-323
Fumigation, cars, in pink bollworm quarantine.....	40-41
Fungus, cause of black stem rust, description and life history.....	78-82
Fur, rabbit, utilization and value.....	151
Game birds. <i>See</i> Birds.	
Garden fertilizer, formula.....	189
Gardens and grounds for laborers' cottages on the farm.....	355-356
Gelatin, imports, statistics.....	628
Georgia, hog-cholera control work, important results.....	192
Germany—	
barberry eradication laws.....	98
rabbit production for meat, 1911.....	146
Giant rabbits, varieties, description.....	148-149
Ginseng, exports, statistics.....	639, 643
Girls' club work, dairy cattle, design and results.....	163
Glucose—	
exports, statistics.....	639, 643, 645, 656
use in brewing.....	709
Glue, imports, statistics.....	628
Goats, numbers—	
in world countries.....	587-591
slaughtered for food.....	31

Grades—	Page.
corn, determination.....	37
grain, establishment.....	343
uniform, benefit to grain industry.....	341-344
Grading—	
cotton, practices, suggestions for improvement.....	416-417
wheat at country elevators, details and advantages.....	336-339, 342-344
Grain—	
acreage and production, and binder twine needed.....	358-359
crops—	
gathering methods, by States.....	689
statistics, 1918.....	449-506
early seeding for prevention of black-stem rust.....	85-86
exports, statistics.....	639, 643, 657
freight tonnage by rail, 1915-1917.....	711
grading appeals, work of supervisors.....	339-340, 342
harvesting, binder-twine consumption.....	358-359
imports, statistics.....	631, 643
industry—	
benefit of uniform grades.....	341-344
changes and dependence on binder-twine supply.....	357-359
losses caused by black-stem rust, 1904-1916, 1918.....	75-77, 94-97
market news service, biweekly statements.....	33-34
products—	
exports, statistics.....	639, 643, 645, 646, 657
imports, statistics.....	631, 643
rye—	
feed use and value, storing and marketing.....	180-182
storing and marketing.....	181
sampling for inspection, directions.....	338, 344
seed, advances to growers in drouth areas.....	46-49
sorghums. <i>See</i> Sorghums.	
standards—	
Act, administration, etc.....	36-37, 59
tabulated corn, wheat, and oats.....	344-346
supervision, Federal, and the farmer, article by Ralph H. Brown.....	335-346
supervisors, Federal, duties in grain grading.....	338, 339, 340, 342
varieties, rust-resistant, selection.....	86-87
<i>See also</i> Barley; Buckwheat; Corn; Oats; Wheat.	
Grape sugar—	
exports, statistics.....	639, 643, 645, 657
use in brewing.....	709
Grapes—	
bushel weights.....	724
imports, statistics.....	631
Grass seed—	
exports, statistics.....	641
imports, statistics.....	633, 664
Grasses—	
susceptibility to black stem rust.....	78, 88, 94-98
weed, eradication for prevention of black stem rust.....	88
GRAVES, HENRY S., article on "Farm woodlands and the war".....	317-326
Grazing—	
allowances in National Forests, 1918.....	719-721
land, area in United States.....	438
live stock on National Forest ranges.....	29-30
Grease, exports, statistics.....	636
Great Britain—	
importation of rabbit meat, 1910, value.....	146
live-stock conditions, 1909-1918, losses, etc.....	293-295
treaty for protection of migratory birds.....	307, 308
Green manure, rye, value.....	177-178
GREENE, JOHN B., citation on riparian rights.....	235
Guernsey Breeders' Association, Grove City, Pa.....	162
Gulf States, citrus canker, eradication work.....	43
Gums, imports, statistics.....	630, 643, 650-651
Gun, size allowed in hunting migratory birds.....	311

	Page.
Hair—	
exports, statistics	636
imports, statistics	628
Hare, Belgian—	
boom in 1899, spread and decline	147
description	149-150
Harvest labor, supply by cities	49-50
Harvesting machines, demand for binder twine	358-359
Hawaii—	
cane-sugar production, 1913-1918	567
shipments to and from United States, 1916-1918, statistics	653
Hawaiian Islands, Sisal industry, progress and problems	364-365
Hay—	
acreage—	
production and farm value, by States, 1918	521
production and farm value, revised, 1879, 1889-1909	521
production, value, exports, etc., 1849-1918	520
alfalfa and prairie, prices on farm, 1914-1918	526
baling, percentages, by States	686
crop variation yearly, graphic showing	690
exports, statistics	639, 643
freight tonnage, by rail, 1915-1917	711
imports, statistics	631, 643
market-news service, biweekly statements	33-34
price on farms first of months, 1909-1918	523
prices on principal markets, 1913-1918	524
production, decrease since 1916	15
statistics, acreage, yield, value, prices, exports, etc.	520-526
stocks, May 1, 1910-1918	523
timothy and clover, prices on farm, 1914-1918	526
wild, salt and prairie, average production and value, by States	525
yield, price Dec. 1, and value, by States	522
Health—	
Public Service, aid in promotion of rural health	73
rural, improvement	72-73
Hemp, imports, statistics	629, 647
Henequen—	
binder-twine fiber, and sisal, article by H. T. Edwards	357-366
crop, value per acre	362
fiber, percentage of worlds' binder twine	359
growing in United States territory	363
plant, growing, localities, and requirements	360-362
Herds—	
accredited, official lists, issue and revision	217
cattle, accrediting, methods and rules	215-217
Hess, O. B., article on "Less cholera, more hogs"	191-194
Hickory, value and uses	318-321
Hides—	
and leather, freight tonnage by rail, 1915-1917	711
exports, statistics	591, 636
imports, statistics	591-592, 628, 649, 661
statistics, exports and imports, 1909-1917	591-592
<i>See also</i> Skins.	
Highway Council, United States, organization and work	56-57
Highways, construction work, and cooperation of Highways Council	55-57
Hill, corn planting method in use among Indians	128
Hog cholera, control, article by O. B. Hess	191-194
Hogs—	
feeding on skim milk, profits	275
inoculation for cholera control, extent	26-27, 192
losses—	
decrease by control of cholera	191-194
from disease yearly, graphic showing	708
in European countries during war	293, 294, 296, 297
number—	
in world countries	587-591
on farms, 1910-1918	13, 15
slaughtered for food	31

	Page.
Hogs—Continued.	
prices.....	622-625
prices cycle, graphic showing.....	707
production increase by cholera-control work.....	191-194
receipts at stockyards, December, 1917 and 1918.....	394-397
shipments, reports, Dec. 19, 1918.....	384-387
statistics, number, value, and prices.....	622-625
Holstein-Friesian Bull Association, Grove City, methods and work.....	161
Home—	
conveniences for laborers' houses on farms.....	348-352, 355
farm, electricity requirements for light and power.....	222-225, 236-238
mixing of fertilizers, article by C. C. Fletcher.....	185-190
Homemade electric power plant.....	237-238
Hominy, preparation, Indian method.....	131
Honey—	
exports, statistics.....	635
imports, statistics.....	628
Hopi corn-planting method, description.....	127
Hops—	
exports—	
and imports, 1909-1917.....	556
statistics.....	639, 643, 646, 657
imports, statistics.....	631, 647
movement and consumption, 1908-1918.....	709
prices, 1913-1918.....	554
statistics, acreage, production, value, exports and imports.....	552-556
use in brewing.....	709
world crop, statistics.....	552-553
Horseflesh, use to supplement beef.....	146
Horsepower available from stream flow, calculating.....	232-235
Horses—	
exports, statistics.....	635, 654
farm, weights, by States.....	704
feed and bedding, rye, use.....	180, 182
imports—	
and exports, 1893-1918.....	601
statistics.....	627
influenza, control.....	28
number—	
and value on farms, 1867-1919.....	596
in world countries.....	587-591
on farms, 1910-1918.....	13, 15
per plow, by States.....	705
prices—	
1900-1918, 1910-1918, and 1902-1918.....	598, 599
cycle, graphic showing.....	705
protection against foreign diseases, quarantine precautions.....	244-245
shipments, reports, Dec. 19, 1918, and mules.....	384-387
sickness, African, fatal disease, need of quarantine precautions.....	245
statistics, number, value prices, imports and exports.....	596-601
supply, European countries and United States.....	294, 296, 297, 299-301
Household appliances, electrical power requirements.....	224, 236
<i>See also</i> Home.	
Houses—	
farm laborers, plans, with grounds.....	352-356
for farm workers, article by E. B. McCormick.....	347-356
Houston, D. F., report of the Secretary of Agriculture, 1918.....	9-73
Hunting—	
laws, States, effect of treaty act.....	309-310
permits, for control of injurious birds.....	314-315
“Husared” corn, preparation, Indian method.....	131
Hutch, rabbit, illustration.....	151
Hydrocyanic-acid gas, fumigation of cars for pink bollworm.....	40-41
Idaho—	
Forests, National, area.....	717
rodents extermination.....	29
Illinois—	
apple growing, localities, varieties, and production.....	370, 373, 378
thrashing ring success, examples.....	265, 267

Imports—	Page.
agricultural, statistics.....	627-635, 642, 647-651, 661-665
barley and malt, by countries.....	489
cotton by countries, 1909-1917.....	536
cottonseed oil, by countries, 1909-1917.....	537
potatoes, 1911-1917.....	516
rice, by countries, 1909-1913, 1916-1917.....	506
seed, 1914-1918, effects of the war.....	195-197
sugar, statistics.....	570
tobacco, by countries, 1909-1917.....	544
India rubber—	
exports and imports.....	584
imports, statistics.....	630, 650-651, 665
statistics, exports and imports.....	584
Indiana—	
thrashing ring success, example.....	267
wheat, stem rust, spread from the barberry.....	94-95
Indians, corn growing and uses, primitive methods.....	123-132
Indicators, plant, use by Indians in corn growing.....	129, 132
Index numbers, crop production, prices and values.....	701
Indigo, imports, statistics.....	631, 643
Information Service, work.....	51-52
Inspection—	
meat—	
Federal statistics, 1907-1918.....	625-626
work.....	30-31
food products, 1918.....	35-36
produce shipments, cost and certificates.....	284-285
Inspectors—	
cattle loan, duties.....	101-102
tuberculosis, address list.....	218-219
Insurance, cotton in warehouses, practices, rates, etc.....	423-426
Interest rates on cattle loans, factors affecting.....	104-105, 108
Iowa, drainage of swamp lands, cost.....	140
Irrigation—	
farms, numbers and demand for land.....	437
lands available for opening by, area.....	437
Istle, imports, statistics.....	629
Ivory, vegetable, imports, statistics.....	630
Jersey Bull Association, Grove City, Pa., methods and work.....	161
Jute, imports, statistics.....	629, 647, 663
Kale seed growing, localities, acreage, yield, production, and consumption....	202, 206, 207
Kanred, wheat variety, resistant to black stem rust.....	87
Kansas, apple growing, localities, varieties, and production.....	370, 373, 378
Kapoc, imports, statistics.....	629
Kentucky, poultry community breeding, organization and work.....	110-111
KIERNAN, J. A., article on "The accredited-herd plan in tuberculosis eradication"	215-220
KINGHORNE, J. W., article on "Better poultry through community breeding associations"	109-114
Labor—	
Department, cooperation with.....	49
farm—	
hiring, classes, etc., by States.....	695-696
supply, work of Department.....	49-50
thrashing, cooperative ring ownership <i>v.</i> hiring.....	262-268
thrashing rings, advantages, saving, etc.....	257-259
wages—	
for men on farm, by classes and States, 1910-1918.....	697
on farm, 1866-1918.....	698
Laborers, farm, housing with city conveniences.....	347-356
Lacey Act, relation to traffic in game birds.....	310
Lambs—	
prices cycle, graphic showing.....	706
trade conditions, receipts and prices, December, 1918.....	382

Land—	Page.
acreaage, tillable, and acreage in crops, 1918.....	63
agricultural, by countries.....	715
arable in United States, article by O. E. Baker and H. M. Strong.....	433-441
settlement and ownership, promotion.....	62-66
Lands—	
abandoned, Eastern United States, area and outlook.....	437, 441
clearing after drainage, costliness.....	140-142
irrigable, area and development.....	437
nonarable, United States, extent, etc.....	434-435, 438
swamp and wet, area in United States.....	137-138
undrained, area in United States.....	137-138
Lard—	
compounds, exports, statistics.....	636, 645, 655
exports, statistics.....	636, 645, 655
Law—	
migratory birds, administration by Biological Survey.....	315-316
migratory-bird, of 1913, and its repeal in 1918.....	305-306
Laws—	
barberry eradication.....	98-99
drainage, districts, bonds, etc.....	139-140
State—	
bird protection, 1870-1918, and effect of treaty act.....	303-305, 309-310
farm loans.....	62
LAWYER, GEORGE A., article on "Federal protection of migratory birds".....	303-316
Legislation—	
agriculture improvement.....	59-60
stockyard regulation, importance.....	69-70
LEIGHTY, CLYDE E., article on "The place of rye in American agriculture".....	169-184
Lemons—	
exports, statistics.....	639
imports, statistics.....	631, 649
Lettuce seed, growing, localities, acreage, yield, production, and consumption.....	202, 206, 207
Liberty tree, name applied to black walnut, note.....	319
Licorice-root, imports, statistics.....	631, 643, 647
Light, electric, and power, from small streams, article by A. M. Daniels.....	221-238
Lighting, farm home, electrical power requirements, estimating.....	222-224, 236
Liquors, alcoholic—	
exports, statistics.....	640, 643
imports, statistics.....	632, 643
Live stock—	
and Meat Trade News, weekly bulletin.....	397-398
associations, list, with officials.....	448
at stockyards, reports monthly.....	393-397
conditions created by the war.....	289-294, 296-298
conditions in Europe, review.....	291-299
feeding, rye, value and methods of use.....	180-181
grazing on National Forest ranges.....	29-30
industry, benefit of cattle loans.....	108
loadings, daily reports.....	384-390
losses caused by disease.....	239-240
market news service.....	32-33
market reports, Federal (and meats), article by James Atkinson.....	379-398
market reports, made several times a day.....	390-391
marketings yearly on principal markets.....	704
markets, improvement by supervision of stockyards.....	68-69
movements in grazing and feeding sections.....	391
number and value, United States, Jan. 1, 1910-1919.....	702-703
numbers in world countries.....	587-591
prices cycle, graphic showing.....	705
production—	
future course for American breeders.....	301-302
increase, 1910-1918, and values.....	13, 14, 15
increase, work of Animal Industry Bureau.....	24
products, quarantine precautions.....	241, 243, 244
quarantine for disease, some results, article by G. W. Pope.....	239-246
relation to reconstruction article by G. M. Rommel.....	289-302

Live stock—Continued.	Page.
statistics, 1918.....	587-626
value comparisons, 1918, 1919, and average.....	703
Loans—	
cattle—	
and their value to investors, article by Charles S. Cole.....	101-108
procedure, essentials, and collateral.....	102-103
rediscounting and safeguarding.....	105-106
size, length of time, and liquidity.....	103-104, 106
to poultry associations, management.....	112
seed-grain, to growers in drouth areas.....	46-49
Locust, black, value and uses in shipbuilding.....	318, 320
Logwood extract, exports, statistics.....	637, 643
Louisiana, cane-sugar production, 1911-1918.....	567
Lowlands, increase in use for crops.....	441
Lumber—	
exports, statistics.....	638, 643, 650, 659
imports, statistics.....	630, 643, 650-651
Lymphangitis, contagious forms, danger to horses.....	244
Macaroni, imports, statistics.....	631, 649, 651
Machinery—	
farm, electrical power requirements.....	224-225, 236-238
need in clearing timbered land.....	142, 143, 144
Maguey, growing in Philippines, fiber quality, etc.....	363
Mahonia—	
description and susceptibility to black stem rust.....	89, 91
spp., description and susceptibility to stem rust.....	89; 91
Mailing list, Markets Bureau, for market reports.....	398
Maine, Forest, National, area.....	717
Malt—	
exports, statistics.....	639
liquors, exports, statistics.....	640
trade, international, with barley, 1911-1913, 1916-17.....	489
use in brewing.....	709
Mangel seed, growing, localities, acreage, yield, production, and consumption..	205-206, 207
Manila, imports, statistics.....	629, 647, 663
Maple sugar and sirup, statistics, production and prices, 1909, 1917, 1918.....	576
Market—	
information, official.....	280, 281, 286-288
news service, branch offices, fruits and vegetables.....	280, 281, 286-288
reports, Federal, on live stock and meats, article by James Atkinson....	379-398
terms, definitions.....	285-286
Marketing—	
competition and cooperation.....	279-280
cotton, relation of warehouse.....	400
live stock on principal markets, 1900-1918.....	704
poultry, community work, advantages.....	113
rye, suggestions.....	181, 182
wood, cooperation advantages.....	323-324
Marketings, corn, by farmers, 1913-1918.....	676
Markets—	
Bureau—	
organization and scope.....	59
reports on live stock and meats.....	379-398
seed reporting service.....	212-214
work for farmers.....	24, 31-36
city, preferences and fancy products.....	280, 282
live-stock, congestion, prevention by official reports.....	391
local reporting service.....	34-35
produce, study, article by G. B. Fiske.....	277-288
terminal, grain mixing and grading.....	341
Maryland, apple growing, localities, varieties, and production.....	370, 372
McCORMICK, E. B., article on "Housing the worker on the farm".....	347-356

	Page.
McCRORY, S. H., article on "The drainage movement in the United States"	137-144
McDOWELL, J. C., article on "How dairying built up a community"	153-168
Meal—	
exports, statistics	639, 645
oil-cake—	
exports, statistics	640, 643, 644
statistics, exports and imports, 1909-1917	582
Meat—	
animals—	
and products, foreign trade, 1904-1918	707
prices in index numbers, 1912-1918	701
exports, statistics	592-593
food supply for Army and Navy, inspection, etc.	31
fresh, supply, daily reports, Bureau of Markets	380-382
imports, statistics	594-595
inspection—	
Federal, statistics, 1907-1918	625-626
service, work, 1918	30-31
packing, regulation and supervision	68-70
prices, daily reports, Bureau of Markets	382-383
production—	
increase, 1910-1918	13, 16, 24-31
increased cost in the United States	145-146
products, exports and imports, 1911-1917	592-595
rabbit, consumption in European countries	146
requirements, increase in the United States	145-146
substitute, cottage cheese	271, 272, 274, 275
supply—	
increase, work of Department	24-31
supplementing by rabbit growing, article by Ned Dearborn	145-152
statistics, exports and imports, 1911-1917	592-595
Meats—	
cured, stocks reported, Dec. 1, 1917, and Dec. 1, 1918	392-393
exports, statistics	636, 644-645, 654-655
freight tonnage by rail, 1915-1917	711
frozen, stocks reported, Dec. 1, 1917, and Dec. 1, 1918	392-393
imported, and quantity condemned, 1914-1918	625
imports, statistics	628
market—	
news service	32-33
reports, Federal (and live stock), article by James Atkinson	367-398
quantity prepared under Federal supervision	625
storage, supply, reports monthly	391-393
supply furnished by America	290-291
trade conditions, receipts, and prices, December, 1918	381-383
<i>See also</i> Beef; Horse flesh; Mutton; Pork; Rabbit.	
Menu, cottage-cheese	272
Mexico, pink bollworm situation, and experiment station work	41-42
Michigan—	
apple growing, localities, varieties and production	370, 373, 378
drainage of swamp lands, 1898-1917, cost	140
Forest, National, area	717
silo construction in 1875, first in America	134
Migratory birds—	
protection, Federal, article by George A. Lawyer	303-316
<i>See also</i> Birds.	
Millet, bushel weights	724
Milk—	
clean, production, rivalry in dairy community	164
exports, statistics	635
production—	
in United States	707
increase since 1914	13, 16
skim—	
food value and utilization	269-271, 273-274, 275
<i>See also</i> Skim milk.	

	Page.
Minnesota—	
Forests, National, area.....	717
wheat, stem rust, spread from the barberry.....	96
wheat yield, and damages by black stem rust.....	76, 96
Mississippi, Bogue Phalia drainage district, acreage and completion.....	140
Missouri—	
Little River drainage district, acreage.....	140
Valley, apple growing, localities, varieties, and production.....	370, 373, 378
Moisture test for wheat, procedure, and per cent allowance.....	337, 339, 344
Molasses—	
exports, statistics.....	641, 643
imports, statistics.....	634, 643, 647
statistics, production, 1911-1918.....	567
Mongrel poultry, disposal methods.....	112-113
Montana—	
Forests, National, area.....	717
rainfall average.....	434
rodents extermination.....	29
wheat-stem rust, spread from the barberry.....	96
Mortgages in cattle loans, essentials and collateral.....	102-103
Motion pictures—	
cottage-cheese demonstrations.....	271-272
Department activity.....	53-54
Motor trucks, hauls farm to shipping point.....	712
Mound, corn-planting method, Omaha Indians, description.....	127
Mountains, regions of nonarable lands.....	434
Mules—	
exports, 1893-1918.....	601
exports, statistics.....	635
farm, weights by States.....	704
number and value on farms, 1867-1919.....	596
numbers in world countries.....	587-591
prices, 1900-1918.....	598
shipments, reports, December 19, 1918, and horses.....	384-387
statistics, number, value, prices, market receipts, and exports.....	596-601
Mushrooms, imports, statistics.....	634
Muskmelon seed, growing localities, acreage, yield, production, and consumption.....	201, 206, 207
Mutton—	
exports, statistics.....	636
production, increase since 1914.....	13, 16
trade conditions, December, 1918.....	382
National Forests. See Forests, National.....	717
Naval stores, exports, statistics.....	637, 643, 650, 659
Navy Department, cooperation with.....	23, 24, 31, 35, 53
Nebraska, Forest, National, area.....	717
Nettle, slender, use in testing seed corn.....	126-127
Nevada, Forests, National, area.....	717
New England—	
Baldwin belt, apple growing, importance.....	371
barberry-eradication laws.....	98
New Hampshire, Forest, National, area.....	717
New Mexico, Forests, National, area.....	717-718
New York, apple growing, commercial, importance and varieties..	369-371, 376, 378
New Zealand flax, imports, statistics.....	629
News—	
Letter, Weekly, enlargement and increase in circulation.....	51
live-stock marketing and movements, desirability.....	70
market-service—	
branch offices, etc., fruits and vegetables.....	280, 281, 286-288
food production and conservation.....	31-36, 71
Service, mimeographed, work of Department.....	51
NEWTON, ROY L., and JAMES M. WORKMAN, article on "Cotton warehousing—	
benefits of an adequate system".....	399-432

	Page.
Nitrogen carriers, composition, and quantities per ton, various percentages....	186,
	188, 189-190
North Carolina—	
clearing lands after drainage.....	141-142
Forest, National, area.....	718
mountain regions, apples, growing and uses.....	370, 376, 378
rural credit law and unions, progress.....	62
North Dakota—	
rodents extermination.....	28-29
wheat yield, and damages by black-stem rust.....	76
Nurse crop, rye, value.....	178
Nursery stock—	
exports, statistics.....	640, 643
importations, restrictions, importance.....	42
imports, statistics.....	632, 643
Nuts—	
exports, statistics.....	640, 643
hickory, bushel weights.....	724
imports, statistics.....	632, 643, 663
<i>See also</i> Almonds; Brazil nuts; Coconuts; Filberts; Oil nuts; Peanuts; Walnuts.	
Oak lumber, value and uses.....	321
Oatmeal, exports, statistics.....	639
Oats—	
acreage—	
production and farm value, 1879 and 1889-1909.....	476
production and farm value, by States, 1917 and 1918.....	476-477
yield, values, exports, etc., 1849-1918.....	475
bushel weights.....	346, 724
condition of crop, first of months, 1898-1918.....	479
consumption, by countries, 1902-1911.....	684
crop variation yearly, graphic showing.....	692
damage by black stem rust.....	75, 76, 96
exports—	
and imports, 1911-1913, 1916-1917.....	482
statistics.....	639
imports, statistics.....	631
marketings monthly by farmers, 1913-1918.....	683
price on farm first of month, 1909-1918.....	479
prices on principal markets, 1913-1918.....	480-481
production and distribution, United States, 1897-1918.....	477
standards, tabulated.....	346
statistics, acreage, yield, values, prices, exports, etc.....	473-482
trade, international, 1911-1913, 1916-17.....	482
weight per bushel, different grades.....	346, 724
world's area and production, 1916-1918.....	473-474
yield, price December 1, and value by States.....	478
Ohio, thrashing ring, success examples.....	266-267
Oil—	
cake—	
exports and imports.....	582
exports, statistics.....	640, 643, 645
imports, statistics.....	633, 643
statistics, exports and imports, 1909-1917.....	582
Chinese nuts, imports, statistics.....	633
cottonseed, trade, international, 1909-1917.....	537
nut, imports, statistics.....	633
Oils—	
vegetable—	
exports, statistics.....	640, 643, 646, 658
imports, statistics.....	633, 643, 663
volatile—	
exports, statistics.....	640
imports, statistics.....	633
Oklahoma, Forests, National, area.....	718
Olive oil, imports, statistics.....	633, 648, 651
Olives, imports, statistics.....	631

	Page.
Onions—	
bushel weights.....	724, 726
farm prices, 1910-1918.....	710
imports, statistics.....	634, 648
seed and sets, growing localities, acreage, yield, production, and consumption.....	203, 206, 207
Open seasons for wild birds, State laws, general conditions.....	304-305, 311, 312
Opium imports, statistics.....	633, 643, 648, 663
Oranges—	
exports, statistics.....	639, 656
imports, statistics.....	631, 649
prices on farm, 1908-1918.....	551
statistics, production and prices.....	551
Orchards—	
commercial, distinction from home orchards.....	368-369
farm, distinction from commercial orchards, uses, waste, etc.....	368-369
Oregon—	
apple-growing, localities, varieties, and production.....	370, 375, 378
Forests, National, area.....	718
Ozark region, apple growing, localities, varieties, and production.....	370, 373, 378
Pacific States, apple growing, localities, varieties, and production.....	370, 374-375, 377, 378
Packing—	
houses, regulation and supervision.....	68-70
industry, relation to corn growing, tonnage, etc.....	133-134
Packing-house—	
products—	
exports, statistics.....	636, 643, 644-645
imports, statistics.....	628, 629, 642, 661
tonnage, 1914, 1915, 1916.....	133
Palm oil, imports, statistics.....	633
Paper, cattle loans, buyers, factors influencing.....	107
Parsley seed growing, localities, acreage, yield, production and consumption.....	202, 206, 207
Parsnip—	
bushel weight.....	726
seed growing, localities, acreage, yield, production, and consumption.....	203, 206, 207
Pasturage, value of land periodically wet, note.....	137
Pasture crop, rye, value.....	179
Pastures—	
acreage and carrying capacity.....	722
extent in United States, note.....	439
Peach, crop centralization.....	690
Peaches—	
bushel weights.....	725
prices on farm, 1910-1918.....	550
statistics, production and prices.....	549-550
Peanut oil, imports, statistics.....	633
Peanuts—	
bushel weights.....	725
exports, statistics.....	640
imports, statistics.....	632
prices on farm, 1910-1918.....	562
statistics, acreage, production, value, and prices.....	562
Pears—	
bushel weights.....	725
prices on farm, 1910-1918.....	551
statistics, production and prices.....	550-551
Peas—	
bushel weights.....	725, 726
imports, statistics.....	634
seed growing, localities, acreage, yield, production and consumption.....	204, 206, 207
statistics, acreage and production, 1915-1917.....	560
world crop, 1915-1917.....	560

	Page.
Pennsylvania—	
apple growing, localities, varieties, and production.....	370, 372, 378
Grove City, dairying, benefits to community.....	153-168
Pepper—	
imports, statistics.....	634
seed growing, localities, acreage, yield, production, and consumption.....	200, 206, 207
Percheron horses, breeding animals, demand in France and England.....	300, 301
Permits, hunting, for control of injurious birds.....	314-315
Philippine Islands, fibers, growing for binder twine.....	363-364
Phormium fiber, use in making binder twine.....	359
Phosphoric acid carriers, composition, and quantities per ton, various percentages.....	186, 188, 189-190
Pickles—	
exports, statistics.....	641
imports, statistics.....	634
Piedmont apple-growing region, varieties, and production.....	370, 372, 378
Plans, houses for workers on farms.....	352-356
Plants, season indicators, use by Indians in corn growing.....	129, 132
Pleuropneumonia, prevention in United States.....	240-241
Plow lands, value by States, 1916-1919.....	699
Plowing—	
depth, fall and spring, by States.....	700
Illinois and Indiana, classification by depths.....	700
Plum, ground, use by Indians in soaking corn seed.....	126
Plums, imports, statistics.....	648
Pop corn, prices on farm, 1912-1918.....	678
POPE, G. W., article on "Some results of Federal quarantine against foreign livestock diseases".....	239-246
Population—	
agricultural, by countries.....	713-714
increase, and consequent demands on farmers.....	64
Pork—	
exports, statistics.....	636, 645, 655
production—	
increase.....	291, 301-302
increase, result of cholera control work.....	192
increase since 1914.....	13, 16, 25
trade conditions, December, 1918.....	382
Porto Rico—	
Forest, National, area.....	718
henequen and sisal fibers, growing and cleaning.....	365
shipments to and from United States, 1916-1918, statistics.....	653
Potash carriers, composition, and quantities per ton, various percentages.....	186, 188, 189-190
Potatoes—	
acreage—	
and production, 1910-1918.....	14, 15
production and farm value by States, 1918.....	510
production and farm value, revised, 1889-1909.....	510
production, value, exports, etc., 1849-1918.....	509
condition first of months, 1897-1918.....	511
crop variation yearly, graphic showing.....	691
exports—	
and imports, by countries, 1911-1917.....	516
statistics.....	641
harvest each month by States.....	685
imports, statistics.....	634, 648
Irish, bushel weights.....	725, 726
price on farm, first of months, 1909-1918.....	513
prices in principal markets, 1913-1918.....	514-515
sales each month by States.....	686
statistics, acreage, yield, value, prices, exports, etc.....	507-516
stocks, January 1, by States, 1915-16.....	512-513
sweet—	
bushel weights.....	725, 726
<i>See also</i> Sweet potatoes.	
trade, international, 1911-1917.....	516
world's area, production, and yield, 1915-1917.....	507-508
yield, price December 1, and value by States.....	511-512

	Page.
Poultry—	
associations, community, organization method.....	111-112
breed, selection for community work.....	109-110, 111
breeding associations, community, article by J. W. Kinghorne.....	109-114
exhibits, community.....	114
exports, statistics.....	636
freight tonnage by rail, 1915-1917.....	711
improvement, advantage of concentration on one breed.....	109-110
marketing, community work, advantages.....	113
production increase since 1914.....	13, 16, 25
products, market news service.....	33
Power—	
electric, and light, from small streams, article by A. M. Daniels.....	221-238
thrashing outfit, selection, guide, note.....	253
water—	
from small streams, utilization on farms.....	235-238
latent sources, utilization on farms.....	221-222, 238
Prairie—	
dogs, extermination work.....	28-29
hay, prices on farm, 1914-1918.....	526
Predatory animals, extermination.....	28-29
Prevention of disease, importance in quarantine work.....	246
Produce—	
inspection, cost, and value of certificates.....	285
supply and demand, study of market, article by G. B. Fiske.....	277-288
Protection, Federal, of migratory birds, article by George A. Lawyer.....	303-316
Prices—	
beef, daily reports, December, 1918.....	382-383
cotton, influence of warehousing.....	400-403
farm, graphic showing of trend.....	698
farmers', for principal articles bought, 1909-1918.....	694-695
live stock cycle, graphic showing.....	705-707
monthly, in index numbers, 1909-1918.....	701
seed, 1917, 1918, effect of the war.....	209-211
timber in National Forests.....	716
Prunes—	
exports, statistics.....	639, 645, 656
imports, statistics.....	648
Publications—	
distribution, work of Department.....	50-51
on cottage cheese.....	276
<i>Puccinia—</i>	
<i>graminis</i> . See Stem rust, black.	
spp., characteristics and hosts.....	77
Pulp wood—	
imports, statistics.....	631
statistics, exports and imports, 1909-1917.....	586
Pumpkin seed growing, localities, acreage, yield, production, and consumption.....	201, 206, 207
Quarantine—	
cotton from Mexico on account of pink bollworm.....	28, 40-41
live-stock diseases, some results, article by G. W. Pope.....	239-246
Quebracho wood and extract, imports, statistics.....	630
Quince, bushel weight.....	726
Rabbit—	
breeding, information furnished by Department.....	152
breeds, description.....	148-150
clubs, work in production of meat and fur.....	152
Flemish giant, origin and description.....	149
giant, varieties, description.....	148-149
growing, profits, instances.....	148
meat, imports into Great Britain, 1910, value.....	146
New Zealand red, description.....	105
skins, utilization and value.....	151

	Page.
Rabbits—	
growing—	
at home, profits.....	150-151
in America, utility breeds, and outlook.....	147-152
to supplement meat supply, article by Ned Dearborn.....	145-152
substitute for chickens, experiment and results.....	148
use for meat in European countries.....	146
Radish, seed growing, localities, acreage, yield, production, and consumption.....	203, 206, 207
Railroad ties, exports, statistics.....	638
Railways, freight tonnage, United States.....	711
Rainfall, minimum for crops without irrigation.....	434
Raisins—	
exports, statistics.....	639
imports, statistics.....	631, 648
Ranges, National Forests, live-stock grazing.....	29-30
Rapeseed oil, imports, statistics.....	633
Recommendations, Secretary of Agriculture.....	58, 68, 69, 70, 71, 72
Reconstruction, live stock situation, article by G. M. Rommel.....	289-302
Records, cow-testing association, Grove City, Pa.....	160
Reporters, voluntary, work for Crop Estimates Bureau, compensation.....	44
Reports—	
market, Federal, on live stock and meats, article by James Atkinson... ..	379-398
meat and live stock, samples.....	381-387, 389-390, 392-397
Rice—	
acreage—	
production and farm value, by States, 1918.....	504
production, value, and condition, 1904-1918.....	504
bushel weights.....	725
condition of crop, first of month, 1904-1918.....	504
consumption, by countries, 1902-1911.....	684
destruction by birds, prevention.....	304-315
exports, by countries, 1909-1913, 1916-17.....	506
exports, statistics.....	640, 643, 646
imports, statistics.....	633, 643, 648
price on principal markets, 1913-1918.....	505-506
statistics, acreage, yield, values, prices, exports, etc.....	503-506
trade, international, 1909-1913, 1916-17.....	506
use in brewing.....	709
varieties, plantings in leading States, 1916-1918.....	683
world's acreage and production, 1915-1917.....	503-504
yield, price Dec. 1, and value, by States.....	505
Rinderpest, serious nature, and strict quarantine excluding.....	243-244
Ring, thrashing. <i>See</i> Thrashing ring.	
Riparian rights, explanation by John B. Greene.....	235
Road materials, applications for.....	56, 57
Roads—	
construction—	
importance from all standpoints.....	67-68
work of Department and highways council.....	55-57
Federal aid—	
act, results.....	59
funds and projects for 1919 and 1920.....	66-68
projects submitted and approved.....	55
system, need in National Forests in fire control.....	58
Roasting ears, preparation, Indian method.....	131
Rodents, extermination, State campaigns, cooperative.....	28-29
ROMMEL, GEORGE M., article on "Live stock and reconstruction".....	289-302
Rosen rye, origin and value.....	176
Rosin—	
exports—	
and imports.....	582-583
statistics.....	637, 650, 659
statistics, exports and imports, 1909-1917.....	582-583
Rubber—	
imports, various forms, statistics.....	630, 643, 650-651
statistics, exports and imports.....	584
RUNDLES, J. C., article on "The thrashing ring in the corn belt".....	247-268

Rural—	Page.
credits, organization and development.....	60-62
health and sanitation, improvement and promotion.....	72-73
population, statistics.....	713
Rust, black stem, and the barberry, article by E. C. Stakman.....	75-100
Rusts, grain, characteristics and hosts.....	77
Rutabagas, bushel weight.....	726
Rye—	
acreage—	
production and farm value by States, 1918.....	493
production and farm value, revised, 1879 and 1889-1909.....	492
production, value, exports, etc., 1849-1918.....	491-492
sown and harvested, United States, 1906-1918.....	493
bushel weights.....	725
comparison with wheat for bread, straw and soil improvement.....	171-174
condition on first of month, 1892-1918.....	494
consumption by countries, 1902-1911.....	684
exports—	
and imports, 1911-1913, 1916-1917, by countries.....	496
statistics.....	639
grain, feed use, storing and marketing.....	180-181
place in American agriculture, article by Clyde E. Leighty.....	169-184
price—	
on farm, 1st of month, 1909-1918.....	495
on principal markets, 1913-1918.....	495
production, increase since 1849, annual since 1909.....	169-171
statistics, acreage, yield, values, prices, exports, etc.....	490-496
trade, international, 1911-1913, 1916-1917, by countries.....	496
use in distilling.....	181
varieties, winter and spring, adaptation and value.....	175-176
world production, and leading countries.....	171
world's area and production, 1916-1918.....	490-491
yield, prices Dec. 1, and values by States.....	494
Sago, imports, statistics.....	633, 643
SALE, J. W., and W. W. SKINNER, article on "Composition and food value of bottled soft drinks".....	115-122
Sales—	
game birds, prohibition.....	313
produce, at shipping points.....	284
Salsify, seed growing, localities, acreage, yield, production, and consumption.....	200, 206, 207
Sampling—	
cotton, practices, cause of loss to growers, suggestions.....	416-417
grain for inspection, directions.....	338, 344
Sands, relation to arable land conditions.....	434
Sanitation, rural, improvement.....	72-73
Sausage—	
casings—	
imports, statistics.....	629
statistics.....	636
exports, statistics.....	636
Scabies, sheep and cattle, control work.....	28
Secretary. See Agriculture.	
Seed—	
beans, weevil detection by signs.....	327, 331-333
corn—	
selection and storing, Indian practices.....	129-130, 132
soaking before planting, Indian customs.....	126
testing, etc.....	675-676
testing methods, primitive.....	126-127
distribution, cooperative work.....	34
grain, advances to growers in drought areas.....	46-49
industry of United States, effects of the war, article by W. A. Wheeler and G. C. Edler.....	195-214
reporting service of Bureau of Markets.....	212-214
statistics for clover and timothy, acreage, production, value and prices..	527-529
timothy, farm price, 1910-1918.....	527

	Page.
Seeds—	
exports, statistics.....	641, 643
field and vegetable, stocks on hand during the war.....	208
home growing, increase, effects of the war.....	195
imports—	
and exports, 1914–1918, effects of the war.....	195–197
statistics.....	633, 643, 664
market news service.....	34
prices, 1917, 1918, effect of the war.....	209–211
vegetable—	
exports, 1914–1918.....	196, 198
growing, localities, acreage, yield, production, and consumption....	199–208
Seedsmen, problems, changes in conditions of trade.....	211–212
Serum, antihog-cholera, use at stockyards.....	27
Sewage, creamery, disposal, cooperative research.....	154
Sheep—	
breeds, per cent of flocks, by States.....	617
grazing, National Forests.....	29
imports—	
exports, and prices 1893–1918.....	614
statistics.....	627
losses in European countries.....	293, 295, 296, 297, 302
number and value on farms, 1867–1919.....	613
numbers—	
in world countries.....	587–591
on farms, 1910–1918.....	13, 15
slaughtered for food.....	30–31
on ranges, information due to market reports of Markets Bureau.....	388
prices.....	615, 616
prices, cycle, graphic showing.....	706
receipts at stockyards, December, 1917 and 1918, reports.....	394–397
scab, control.....	28
shipments, reports, December 19, 1918.....	384–387
statistics, number and value, imports, exports, and prices.....	613–617
Shellac, imports, statistics.....	630, 650–651
Shenandoah-Cumberland, apple growing region, notes.....	370, 372, 377, 378
Shipbuilding, demand for black locust, ash, and oak.....	320, 321
Shipments, live stock, daily reports.....	384–390
Shippers, market study, steadying influence.....	278–279
Shipping Board, soda nitrate, purchase and transportation.....	54–55
Sign language of Nature, well known among farmers.....	327
Silage crop, rye, value.....	179
Silk—	
imports, statistics.....	627, 642, 647, 661
statistics, world production, 1913–1917 and 1900–1917.....	585
Silo construction beginning in Europe and America.....	134
Silos—	
number and capacity, 1917, and relation to corn crop.....	134
number and capacity in United States.....	677
Sirup—	
exports, statistics.....	641, 643
maple, statistics, production, and prices, 1909, 1917, 1918.....	576
sorghum, production, prices, and values, 1917, 1918.....	577
<i>See also Molasses.</i>	
Sisal—	
and henequen as binder-twine fibers, article by H. T. Edwards.....	357–366
binder-twine fiber, and henequen, article by H. T. Edwards.....	357–366
crop, value per acre.....	362
fiber percentage of world's binder twine.....	359
growing in United States territory.....	363–366
imports, statistics.....	629, 648, 663
industry, Philippines, Hawaii, Porto Rico, and Florida.....	363–365
Skin milk—	
feeding to hogs or humans, comparative profits.....	275
food value and utilization.....	269–271, 273–274, 275
waste in factories, etc.....	269–270, 272, 273
SKINNER, W. W. and J. W. SALE, article on "Composition and food value of bottled soft drinks".....	115–122

	Page.
Skins—	
exports, statistics.....	591, 636
imports, statistics.....	592, 628, 649, 661
rabbit, utilization and value.....	151
statistics, exports and imports, 1909-1917.....	591-592
<i>See also Hides.</i>	
Smut, corn, food use by Indians.....	131
Soda nitrate, purchase and distribution to farmers.....	24, 54-55
Soft drinks. <i>See Drinks.</i>	
Soil—	
improvement—	
rye and wheat comparison.....	173
rye, value.....	177-178
management for prevention of black stem rust.....	85
requirements of henequen and sisal.....	362
types, swamp lands, and drainage problems.....	138-139
Soiling crop, rye, value.....	178-179
Sorghum for sirup, statistics, acreage, production, prices, etc.....	577
Sorghums, grain—	
prices on farm, 1916-1918.....	562
statistics, acreage, production, value, and prices.....	561-562
South Dakota—	
Forests, National, area.....	718
wheat, stem rust, spread from the barberry.....	95, 96-97
Southern States—	
cholera control work, important results.....	192
drainage work, notable instances.....	140
Soy bean oil, imports, statistics.....	633, 663
Soy beans, prices on farms, 1913-1918.....	558
Spices—	
exports, statistics.....	641, 643
imports, statistics.....	634-643
Spinach—	
bushel weight.....	726
seed growing localities, acreage, yield, production, and consumption.....	202, 206, 207
Spores, black stem rust, spread method, and overwintering.....	80-84
Squash, seed growing, localities, acreage, yield, production, and consumption ..	201, 206, 207
Squirrels, ground, extermination.....	28-29
STAKMAN, E. C., article on "The black stem rust and the barberry".....	75-100
Standards—	
grain—	
tabulated; Corn, wheat, and oats.....	344-346
work under grain standards act.....	36-37, 59
shelled corn, tabulated.....	344
wheat, tabulated.....	345
Starch—	
exports, statistics.....	641, 643
imports, statistics.....	634, 643
State officers, agricultural, lists.....	443-447
States, laws for bird protection, conditions 1870-1918, etc.....	303-305, 309-310
Statistics—	
crops other than grain.....	507-586
live stock, 1918.....	587-626
Staves, exports, statistics.....	638, 650
Stem rust—	
black—	
and the barberry, article by E. C. Stakman.....	75-100
fungus causing.....	78-80
grains and grasses attacked by.....	78
occurrence, distribution, characters, and hosts.....	75-78
overwintering discussion.....	82-84
reduction by eradication of common barberry.....	88-100
spread from the barberry, typical cases.....	94-98
various races.....	78
Stockyards—	
Chicago, market news distribution.....	33
hogs, treatment with anti-hog cholera serum.....	27
live-stock reports, monthly.....	393-397
regulation and supervision.....	68-70

	Page.
Storage—	
beans, infestation by weevils, signs.....	332-333
cotton—	
benefits of adequate system.....	399-432
cooperation of growers, need and suggestions.....	404-406
meat supply, reports, monthly.....	391-393
straw, rye, uses, packing and marketing.....	181-182
Stream flow, measurement methods, cross-section and weir.....	227-235
Streams, small, electric light and power, article by A. M. Daniels.....	221-238
STRONG, H. M., and O. E. BAKER, article on "Arable land in the United States".....	433-441
Substitutes, flour, rye, value.....	183
Sugar—	
beet, statistics.....	564-566, 571, 572-573
cane, statistics.....	564, 567, 571, 574
exports—	
and imports, statistics, 1909-1917.....	570
statistics.....	641, 643, 646
factories, France, destruction by Germans.....	292
freight tonnage by rail, 1915-1917.....	711
imports, statistics.....	634, 643, 648, 651
maple, statistics, production and prices, 1909, 1917, 1918.....	576
prices, New York market, 1913-1918.....	568-569
statistics, production exports and imports, etc.....	564-576
world production, 1915-1917 and 1895-1918.....	571-574
Sugars, soft drinks, food value, etc.....	118-119, 122
Supervisors, grain, Federal, duties in grading grain.....	338, 339, 340, 342
Surra, eradication by destruction of diseased animals.....	243
Survey, sanitary, rural sections, importance.....	73
Swamp—	
land, area in United States.....	137-138
lands, reclamation for cultivation, remarks.....	436
Swans, protection under Federal regulations.....	312
Sweet potatoes—	
acreage—	
and production, 1910-1918.....	14, 15
production and farm value by States, 1918.....	517
production and value, 1849-1918.....	517
condition on first of months, 1898-1918.....	518
price—	
on farm first of months, 1910-1918.....	518
on principal markets, 1913-1918.....	519
yield, price Dec. 1 and value, by States.....	518
Sweetening in soft drinks, food value.....	118-119, 122
Swine. <i>See</i> Hogs.	
Tanning—	
chestnut wood, demand and use.....	320
materials—	
exports, statistics.....	638, 643
imports, statistics.....	630, 643
Tea—	
exports and imports, 1909-1917.....	577-578
imports, statistics.....	634, 643, 648, 561, 664
prices, New York market, 1913-1918.....	578
statistics, exports and imports and prices.....	577-578
Tenancy, farm, relation to ownership.....	65-66
Tennessee, poultry associations progress.....	111, 112
Tester, nettle, for seed corn, description.....	126-127
Testing—	
cattle, methods and rules for accredited herds.....	216-217
dairy herds for tuberculosis, value.....	162-163
seed corn, primitive methods.....	126-127
Texas—	
border, quarantine service regulations.....	40-41
panhandle, rainfall average.....	434
pink bollworm, eradication and quarantine work.....	38-41
Rio Grande Valley, rainfall average.....	434

	Page.
Thrashing—	
custom, old method, faults.....	247-248
outfits—	
purchase by rings, plan and capital involved.....	255-256
ring ownership and management.....	248-260
ring—	
in the corn belt, article by J. C. Rundles.....	247-268
regulations typical.....	260-262
size, relation to acreage, separator, etc.....	250-253
Tick, cattle, eradication, progress and recommendation.....	26, 72
Ticks, carriers of horse diseases, need of quarantine precautions.....	245
Timber—	
by-products, value in clearing operations.....	144
exports, statistics.....	638, 643, 650, 660
growing for home use on farm woodlands.....	325
lands, clearing after drainage, time and cost.....	141
needs of United States, and lands for production.....	439
sales on National Forests, quantity, price, etc.....	716
Timothy—	
hay, price on farms, 1914-1918.....	526
seed—	
bushel weights.....	725
prices on principal markets, 1913-1918.....	528-529
Tobacco—	
acreage—	
and production, 1910-1918.....	14, 15, 537-538
production and values by types and districts, 1917 and 1918.....	541
production and value by States, 1918.....	537
production, value, condition, etc., 1849-1918.....	539
districts in each State.....	687
exports—	
and imports by countries, 1909-1917.....	544
statistics.....	641, 643, 645, 658
freight tonnage by rail, 1915-1917.....	711
imports, statistics.....	634, 643, 664
prices on principal markets, 1913-1918.....	542-543
statistics, acreage, yield, values, prices, exports, etc.....	537-544
trade, international, by countries, 1909-1917.....	544
yield, prices Dec. 1 and values by States, 1909-1918.....	540
Tomato seed growing, localities, acreage, yield, production and consumption.....	200,
	206, 207
Tomatoes, bushel weights.....	725, 726
Tonnage, packing house, 1914, 1915, 1916.....	133
Tools—	
corn planting, primitive.....	127, 128
hickory demand and uses.....	321
Towns, uses of corn.....	674
Trade—	
foreign, meat animals and products.....	707
News, Live Stock and Meat, weekly bulletin.....	397-398
Trading, primitive methods, and value of corn as exchange.....	124
Traffic in game birds, restrictions.....	310, 311, 313
Transportation—	
hauls by wagon and motor, farm to station.....	712
railway freight tonnage, 1915-1917.....	711
wagon and motor truck hauls.....	712
Treaty, migratory-bird, adoption and terms.....	307-308
Trees, removal from slopes, care in cutting to prevent erosion.....	323
Truck crops, statistics, acreage and production.....	563
Tuberculin testing—	
cattle, for accredited herds, rules.....	216-217
cattle herds.....	28
Tuberculosis—	
eradication—	
future extension.....	219-220
the accredited herd plan, article by J. A. Kiernan.....	215-220
free dairy herds, certificate, value to dairyman.....	162-163
inspectors, address list.....	218-219
livestock eradication work.....	27-28, 72

	Page.
Turkeys, farm prices, 1914-1919.....	710
Turnip seed, growing, localities, acreage, yield, production, and consumption..	203,
Turnips—	206, 207
bushel weights.....	725, 726
farm prices, 1912-1918.....	709
Turpentine—	
exports—	
and imports.....	583
statistics.....	637, 650, 659
imports, statistics.....	630
statistics, exports and imports, 1909-1917.....	583
Twine—	
binder—	
importance in grain industry, consumption, etc.....	358-360
supply, relation to grain industry of world.....	358-360
use of abaca.....	359
United Kingdom, live-stock conditions, 1909-1918, losses, etc.....	293-295
<i>Urtica gracilis</i> , use in making tester for seed corn.....	126-127
Utah, Forests, National, area.....	718
Vanilla beans, imports, statistics.....	634, 643
Veal, trade conditions, December, 1918.....	381
Vegetable seeds—	
exports, 1914-1918.....	196, 198
growing, localities, acreage, yield, production, and consumption.....	199-208
prices, 1917, 1918, effect of the war.....	209-211
Vegetables—	
exports, statistics.....	641, 643
imports, statistics.....	634, 643
market news service, branch offices, etc.....	32, 280, 281, 286-288
production, increase since 1910.....	15
weights of bushel.....	726
<i>See also</i> Beans; Beets; Carrots; Celery; Lettuce; Onions; Peas; Radish; Tomato; Turnips.	
Vehicles, building, demand for hickory and oak woods.....	321
Velocity, stream, measurement, directions.....	227-229
Veterinarians, Federal, hog-cholera control work.....	191-192
Vinegar—	
exports, statistics.....	641
imports, statistics.....	635
Virginia—	
apple-growing regions, varieties and production.....	370, 372, 378
Farmville, poultry work, organization and results.....	110
Forests, National, area.....	718
Wages, farm, by classes.....	697, 698
Wagons, hauls farm to shipping point.....	712
Walnut, black—	
conservation on farms, and replanting.....	319, 324
value and uses, amount cut for war purposes.....	318, 319
Walnuts—	
bushel weights.....	725
imports, statistics.....	632, 649, 663
War—	
boards, food, labor, shipping, etc., cooperation with	23, 24, 35, 44, 49, 53, 54, 55, 57, 61
Department, cooperation with	23, 24, 31, 35, 49, 53, 57, 58
effects upon seed industry of the United States; article by W. A. Wheeler and G. C. Edler.....	195-214
European, corn crop, 1917, use and value as world food.....	135-136
forest products, demands and uses.....	317-326
Labor Policies Board, cooperation with Agricultural Department.....	49
Warehouse—	
Act, purposes and requirements.....	427-432
cooperative cotton, location, requirements.....	406-408
cotton—	
construction and fire protection.....	408-416
construction for fire protection.....	408-414
functions.....	400

	Page.
Warehousing cotton, benefits of adequate system, article by Roy L. Newton and James M. Workman.....	399-432
Washington—	
apple growing importance, localities, etc.....	370, 374-375, 378
Forests, National, area.....	718
Water—	
power—	
from small streams, utilization on farms.....	235-238
latent sources, utilization on farms.....	221-222, 238
legislation need.....	58
principles of determination.....	225-226
rights, landowner, discussion.....	235
Waterfowl—	
open seasons under Federal regulations.....	312
protection by States, 1870-1918, phases of legislation.....	304
Watermelon seed growing, localities, acreage, yield, production, and consumption.....	201, 206, 207
Wax, vegetable, imports, statistics.....	635, 643
<i>See also</i> Beeswax.	
Weather—	
conditions, effect on markets.....	282-283
relation to stem-rust development.....	84
Weed grasses, eradication for prevention of black stem rust.....	88
Weevil holes, detection on freshly harvested beans.....	331-332
Weevils—	
bean—	
life cycle, description and illustrations.....	329-331, 334
plates, description.....	334
beans infestation method, article by E. A. Back.....	327-334
detection in seed beans, signs.....	327, 331-333
origin, fictional beliefs.....	329
signs, detection in seed beans, in the field and in storage.....	327, 331-333
Weighing cotton, equipment, types of scales.....	417-420
Weights, bushel, commodities and States.....	723-726
Weir—	
discharge table.....	232
method of stream measurement.....	230-232
West Virginia—	
apple-growing, localities, varieties, and production.....	370, 372, 378
Forest, National, area.....	718
Western—	
irrigated regions, apple growing.....	370, 374
States, barberry eradication laws.....	99
Wheat—	
acreage—	
and production, 1910-1918.....	12, 14
production, value, exports, etc., 1849-1918.....	460-461
production and farm value by States.....	465
production and value, revised, 1879, 1889-1909.....	462
bushel weights.....	725
comparison with rye for bread, straw, and soil improvement.....	171-174
condition by months, 1890-1919.....	468
consumption by countries, 1902-1911.....	685
consumption per capita by countries.....	681
crop variation yearly, graphic showing.....	691
exports, 1909-1913, 1916-1917.....	472
exports, statistics.....	639, 646, 657
flour—	
mixture with rye in bread making.....	171, 183
prices on principal markets, 1913-1918.....	471
grading—	
and inspection.....	37
at country elevators, details and advantages.....	336-339, 342-344
growing to secure premium grade, precautions.....	335
imports, statistics.....	631, 652
Kanred, resistance to black stem rust.....	87
load, from field to market, story of.....	335-341

	Page.
Wheat—Continued.	
losses caused by black stem rust.....	75-77, 95-97
marketings monthly, 1913-1918.....	680
moisture allowance, per cent for different grades.....	337, 339, 344
new, prices 1918.....	681
price—	
on farm, 1909-1918, by months.....	468
on principal markets, 1913-1918.....	469-470
revised under Government.....	680
production and distribution, United States, 1897-1918.....	466
spring—	
acreae, production and farm value.....	462-463
varieties, yields, by States, 1914-1917.....	682
yield per acre, by States.....	646
standards—	
revision.....	36
tabulated.....	345
statistics, acreae, yield, values, prices, exports, etc.....	458-472
stocks, locations, and use.....	679
trade, international, 1909-1913, 1916-1917.....	472
weights per bushel, different grades.....	337, 345
winter—	
abandoned area, 1909-1918.....	468
acreae, production, and farm value.....	462-463
acreae, sowing compared with harvest.....	682
yield per acre, by States.....	464
world's area and production, 1916-1918.....	458-460
yield, price Dec. 1, and value per acre, by States.....	467
WHEELER, W. A., and G. C. EDLER, article on "Some effects of the war upon the seed industry of the United States".....	195-214
Whisky, imports, statistics.....	632
White Mountain and Appalachian area, Forests, National.....	718
Wines—	
exports, statistics.....	640
imports, statistics.....	632
Winter, cycle of black stem rust, discussion.....	82-84
Wood—	
alcohol, exports, statistics.....	638
exports, statistics.....	637-638, 643
fuel use increased by coal shortage.....	322-323
imports, statistics.....	630, 643, 665
marketing, cooperation advantages.....	323-324
pulp—	
exports, statistics.....	638, 643
imports, statistics.....	631, 643, 650-651, 665
statistics, exports and imports, 1909-1917.....	586
Woodlands—	
extent and importance as arable lands in future.....	436
farm, and the war, article by Henry S. Graves.....	317-326
improvement needs and methods.....	324-325
Woodlots, farm, usefulness in war emergencies.....	317-326
Wool—	
exports—	
and imports, 1909-1917.....	622
statistics.....	635, 643
imports, statistics.....	627, 642, 647, 661
freight tonnage by rail, 1915-1917.....	711
prices.....	616, 619-621
production, 1909-1918.....	13, 16
statistics, production, prices, exports, and imports.....	616, 618-622
Workers, farm, houses for, article by E. B. McCormick.....	347-356
<i>See also Labor.</i>	
WORKMAN, JAMES M., and ROY L. NEWTON, article on "Cotton warehousing— benefits of an adequate system".....	399-432
Wyoming, Forests, National, area.....	718
Yucatan, source of henequen supply, climate, etc.....	359, 360, 361